

User's Information Manual

CONTENTS

	Page
NOTE TO INSTALLER	1
SAFETY CONSIDERATIONS	1
IMPORTANT FACTS	3
TO LIGHT UNIT	3
TO SHUT UNIT OFF	5
ROUTINE MAINTENANCE AND CARE FOR THE EQUIPMENT OWNER	6
Compressor	7
Indoor Air Filter(s)	7
Condenser Fan	8
Electrical Controls and Wiring	8
Combustion Area and Vent System	8
Integrated Gas Controller (IGC)	9
Unit Panels	9
BEFORE YOU CALL FOR SERVICE, CHECK FOR PROBLEMS THAT CAN BE EASILY SOLVED ...	9
IN CASE OF TROUBLE	9
REGULAR DEALER MAINTENANCE	9
Heat Exchanger	9
Fans and Belts, and Fan Motor	9
Evaporator and Condenser Coils	9
Condensate Drain	10

conditions which may cause personal injury or property damage. Consult a qualified installer, service agency, or your distributor or branch for information or assistance. The qualified installer or agency must use factory-authorized kits or accessories when modifying this product. Refer to the individual instructions packaged with the kits or accessories when installing.

Follow all safety codes. Wear safety glasses and work gloves. Use quenching cloths for brazing operations and have a fire extinguisher available. Read these instructions thoroughly and follow all warnings or cautions attached to the unit. Consult local building codes and appropriate national electrical codes (in USA, ANSI/NFPA70, National Electrical Code (NEC); in Canada, CSA C22.1) for special requirements.

It is important to recognize safety information. This is the safety-alert symbol . When you see this symbol on the unit and in instructions or manuals, be alert to the potential for personal injury.

Understand the signal words DANGER, WARNING, CAUTION, and NOTE. These words are used with the safety-alert symbol. DANGER identifies the most serious hazards which will result in severe personal injury or death. WARNING signifies hazards which could result in personal injury or death. CAUTION is used to identify unsafe practices, which may result in minor personal injury or product and property damage. NOTE is used to highlight suggestions which will result in enhanced installation, reliability, or operation.

Should the gas supply fail to shut off or if overheating occurs, shut off the gas valve to the furnace before shutting off the electrical supply.

WARNING

ELECTRICAL SHOCK, FIRE OR EXPLOSION HAZARD

Failure to follow safety warnings exactly could result in dangerous operation, serious injury, death or property damage.

Improper servicing could result in dangerous operation, serious injury, death or property damage.

- Before servicing, disconnect all electrical power to the unit.
- When servicing controls, label all wire prior to disconnecting. Reconnect wires correctly.
- Verify proper operation after servicing.

NOTE TO INSTALLER

This manual should be left with the equipment owner.

SAFETY CONSIDERATIONS

Improper installation, adjustment, alteration, service, maintenance, or use can cause explosion, fire, electrical shock or other

WARNING

If the information in this manual is not followed exactly, a fire or explosion may result causing property damage, personal injury or loss of life.

Do not store or use gasoline or other flammable vapors and liquids in the vicinity of this or any other appliance.

WHAT TO DO IF YOU SMELL GAS

- Do not try to light any appliance.
- Do not touch any electrical switch; do not use any phone in your building.
- Immediately call your gas supplier from a neighbor's phone. Follow the gas supplier's instructions.
- If you cannot reach your gas supplier, call the fire department.

Installation and service must be performed by a qualified installer, service agency or the gas supplier.

⚠ AVERTISSEMENT

RISQUE D'INCENDIE OU D'EXPLOSION

Si les consignes de sécurité ne sont pas suivies à la lettre, cela peut entraîner la mort, de graves blessures ou des dommages matériels.

Ne pas entreposer ni utiliser d'essence ni autres vapeurs ou liquides inflammables à proximité de cet appareil ou de tout autre appareil.

QUE FAIRE SI UNE ODEUR DE GAZ EST DÉTECTÉE

- Ne mettre en marche aucun appareil.
- Ne toucher aucun interrupteur électrique; ne pas utiliser de téléphone dans le bâtiment.
- Quitter le bâtiment immédiatement.
- Appeler immédiatement le fournisseur de gaz en utilisant le téléphone d'un voisin. Suivre les instructions du fournisseur de gaz.
- Si le fournisseur de gaz n'est pas accessible, appeler le service d'incendie.

L'installation et l'entretien doivent être effectués par un installateur ou une entreprise d'entretien qualifié, ou le fournisseur de gaz.

⚠ WARNING

Do not use this furnace if any part has been under water. A flood-damaged furnace is extremely dangerous. Attempts to use the furnace can result in fire or explosion. A qualified service agency should be contacted to inspect the furnace and to replace all gas controls, control system parts, electrical parts that have been wet or the furnace if deemed necessary.

⚠ AVERTISSEMENT

Ne pas utiliser cet appareil de chauffage s'il a été en partie immergé dans l'eau. Un appareil de chauffage endommagé par une inondation est extrêmement dangereux. S'il est utilisé, un incendie ou une explosion peut se produire. Il faut avoir recours à une entreprise d'entretien qualifiée pour faire inspecter l'appareil de chauffage et remplacer toutes les commandes de gaz, les pièces du système de contrôle, les pièces électriques qui sont entrées en contact avec l'eau ou l'appareil de chauffage lui-même, si cela est jugé nécessaire.

⚠ WARNING

Improper installation, adjustment, alteration, service, or maintenance can cause injury or property damage. Refer to this manual. For assistance or additional information, consult a qualified installer, service agency, or the gas supplier.

⚠ WARNING

Before performing recommended maintenance, be sure main power switch to unit is turned off and lockout tag is installed. Electrical shock could cause personal injury.

Your combination heating/cooling rooftop unit is equipped with an automatic direct spark ignition system and induced-draft power combustion blower.

⚠ WARNING

Burners will light automatically. Do not attempt to light by hand; personal injury may result.

⚠ WARNING

CARBON-MONOXIDE POISONING HAZARD

Failure to follow instructions could result in severe personal injury or death due to carbon-monoxide poisoning, if combustion products infiltrate into the building.

Check that all openings in the outside wall around the vent (and air intake) pipe(s) are sealed to prevent infiltration of combustion products into the building.

Check that furnace vent (and air intake) terminal(s) are not obstructed in any way during all seasons.

⚠ AVERTISSEMENT

RISQUE D'INTOXICATION AU MONOXYDE DE CARBONE

Si ces directives ne sont pas suivies, cela peut entraîner des blessures graves ou une intoxication au monoxyde de carbone pouvant causer la mort, si des produits de combustion s'infiltrent dans le bâtiment.

Vérifier que toutes les ouvertures pratiquées dans le mur extérieur autour du ou des tuyaux d'évent (et de la prise d'air) sont scellées de manière à empêcher l'infiltration de produits de combustion dans le bâtiment.

Veiller à ce que la ou les sorties de l'évent de l'appareil de chauffage (et la prise d'air) ne soient, en aucune façon, obstruées, quelle que soit la saison.

⚠ WARNING

Should overheating occur or the gas supply fail to shut off, shut off the manual gas valve to the unit before shutting off the electrical supply.

⚠ AVERTISSEMENT

En cas de température excessive, ou s'il est impossible de couper l'alimentation en gaz, fermer le robinet manuel d'alimentation en gaz du générateur d'air chaud avant de couper l'alimentation électrique.

⚠ WARNING

FIRE, EXPLOSION HAZARD

Failure to follow this warning could result in personal injury, death, and/or property damage.

Do not store or use gasoline or other flammable vapors and liquids in the vicinity of this or any other appliance.

⚠ WARNING

ELECTRICAL SHOCK HAZARD

Failure to follow this warning could result in personal injury, death, and/or property damage.

Before performing maintenance, be sure main power switch to unit is turned off and lockout tag is installed. There may be more than one power switch.

⚠ WARNING

ELECTRICAL OPERATION HAZARD

Failure to follow this warning could result in personal injury, death and/or property damage.

Do not use this equipment if any part has been under water. A flood-damaged equipment is extremely dangerous. Attempts to use the equipment can result in fire or explosion. A qualified service agency should be contacted to inspect the equipment and to replace all gas controls, control system parts, electrical parts that have been wet or the equipment if deemed necessary.

Your rooftop heating/cooling unit is equipped with an automatic, direct spark ignitor and an induced-draft, combustion blower.

⚠ WARNING

PERSONAL INJURY HAZARD

Failure to follow this warning could result in personal injury. Burners will light automatically. Do not attempt to light by hand.

IMPORTANT FACTS

- DO: READ AND UNDERSTAND THIS MANUAL.
- DO: Have your equipment and vent system inspected annually by a qualified service technician.
- DO: Inspect your filter monthly and clean or replace when needed.
- DO: Provide adequate airflow to the equipment for efficient combustion and safe ventilation.
- DO make sure:
 1. All flue and vent connections are clear and free of obstructions, are leak free, and not damaged.
 2. Duct connections are leak free and physically sound.
 3. The unit base support is free of cracks, gaps, etc.
 4. There are no signs of furnace deterioration.
 5. Burners are aligned correctly.
 6. Follow routine maintenance inspection.
- DO NOT: Keep combustible materials, gasoline, and other flammable liquids or vapors around your equipment.
- DO NOT: Cover your equipment in any manner.
- DO NOT: Store anything (including trash or debris) near your equipment.

- DO NOT: In any way block or restrict airflow around your equipment.
- DO NOT: Contaminate the air used for combustion of your equipment with any kind of chemical or fumes. This could also cause heat exchangers, metal vent systems or components to deteriorate.

⚠ DANGER

FIRE AND EXPLOSION HAZARD

1. Do not turn off the electrical power to unit without first turning off the gas supply.
2. Before attempting to start the gas heating section, familiarize yourself with all the procedures that must be followed.
3. Never attempt to manually light the burners on the unit with a match, lighter, or any other flame. If the electric sparking device fails to light the burners, refer to the shutdown procedures, then call your dealer as soon as possible.

If you do not follow these instructions exactly, a fire or explosion may result, causing property damage, injury, or loss of life.

⚠ CAUTION

CUT HAZARD

Failure to follow this caution may result in personal injury. When removing access panels or performing maintenance functions inside your unit, be aware of sharp sheet metal parts and screws. Although special care is taken to reduce sharp edges to a minimum, be extremely careful when handling parts or reaching into the unit.

TO LIGHT UNIT

Step 1

Set room thermostat/unit controller to the lowest temperature setting and set the SYSTEM switch to HEAT or AUTO position. See Fig. 1.

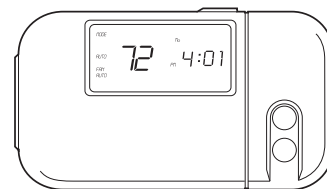

Fig. 1 — Thermostat/Unit Controller

Step 2

Turn off the gas supply by closing the gas supply shut-off valve (external to RTU unit). See Fig. 2 or 3 (depending on the size of the unit) for location and Fig. 4.

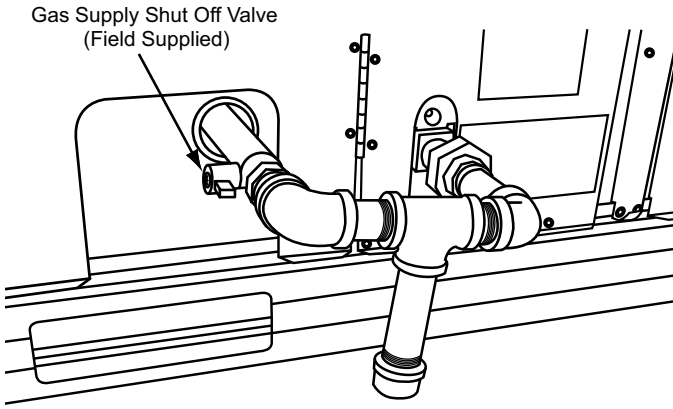

Fig. 2 — Gas Supply Shut-Off Valve Location — 3 to 12-1/2 Ton Units (Thru-the-base gas supply shown)

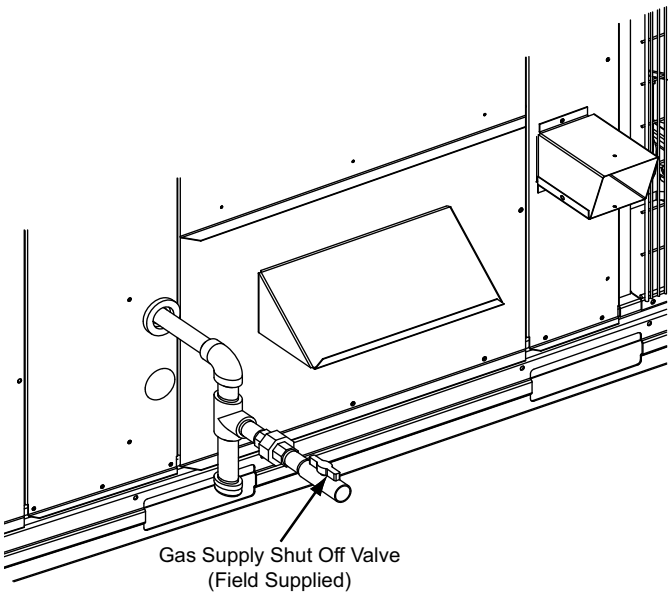

Fig. 3 — Gas Supply Shut-Off Valve Location — 15 to 27-1/2 Ton Units

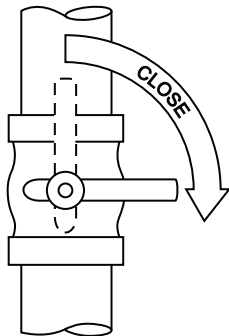

Fig. 4 — Gas Supply Shut Off Valve

Step 3

Turn off the electrical supply to the unit by switching the RTU main disconnect to OFF. Then, ensure personal safety by installing a lockout tag on the disconnect. See Fig. 5.

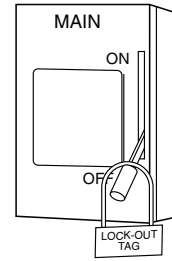

Fig. 5 — RTU Main Disconnect — Electrical Supply Step 4

Remove the gas component access panel. For location of the gas component access panel, see Fig. 6 or 7 (depending on the size of the unit). See Fig. 8 for panel removal.

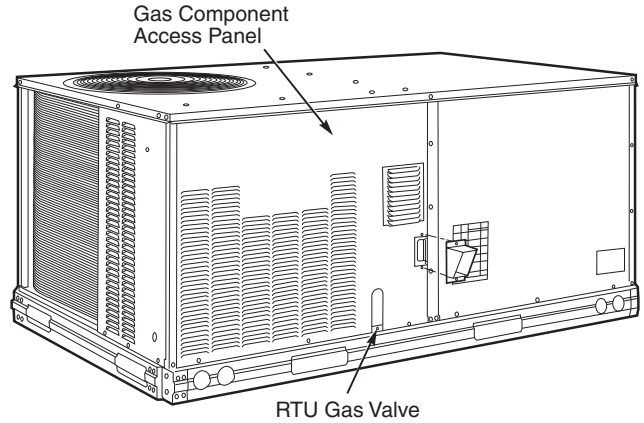

Fig. 6 — Gas Component Access Panel and RTU Gas Valve Location — 3 to 12-1/2 Ton Units

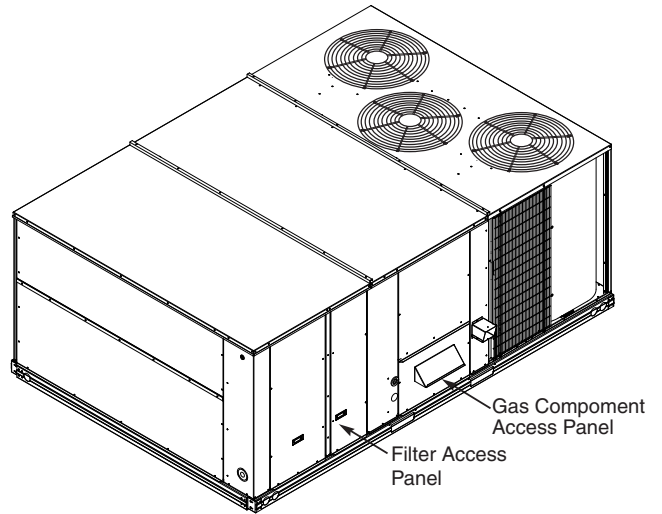

Fig. 7 — Gas Component Access and Filter Access Panels — 15 to 27-1/2 Ton Units

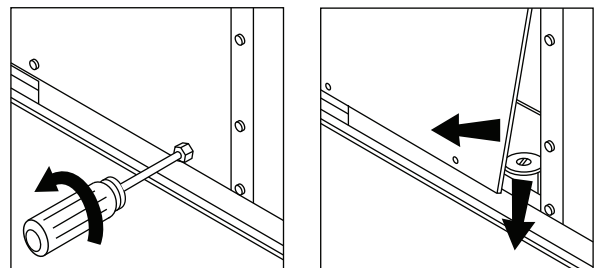

Fig. 8 — Gas Component Access Panel Removal

Step 5

Move the RTU gas valve on/off switch to the OFF position and wait 5 minutes. See Fig. 6 or 7, depending on the type of unit, for location of RTU gas valve. See Fig. 9.

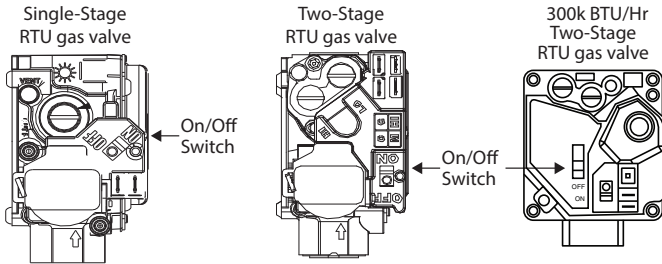

Fig. 9 — Single and Two-Stage RTU Gas Valves

Step 6

Move the RTU gas valve on/off switch to the ON position.

Step 7

Replace the gas component access panel. See Fig. 10.

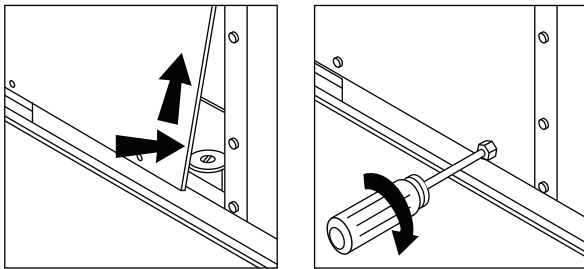

Fig. 10 — Replacing the Gas Component Access Panel

Step 8

Remove disconnect lockout tag and restore power to the unit by switching the RTU main disconnect to ON. See Fig. 11.

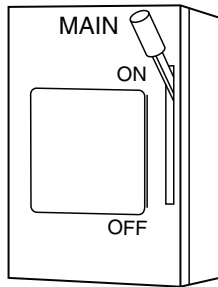

Fig. 11 — RTU Main Disconnect — Electrical Supply

Step 9

Turn on the gas supply by opening the gas supply shut-off valve. See Fig. 12.

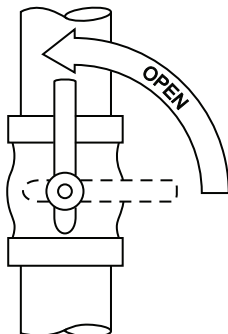

Fig. 12 — Gas Supply Shut Off Valve

Step 10

To start unit, set room thermostat/unit controller heat setpoint to slightly above room temperature. The induced-draft combustion air fan will start. The RTU gas valve will open and main burners should ignite within 5 seconds. If the burners do not light, there is a 22 second delay. Burners will attempt to ignite within 5 seconds. Each time the burner fails to light, the 22 second time delay is repeated. If the burner does not light within 15 minutes, the unit will lockout the gas heat. To reset after a lockout, turn off the main electrical supply to the unit by switching the RTU main disconnect to OFF for a minimum of five seconds. Repeat Steps 1-10. If burners still do not light, call for service.

Step 11

Set the room thermostat/unit controller heating set point to desired temperature setting. See Fig. 13.

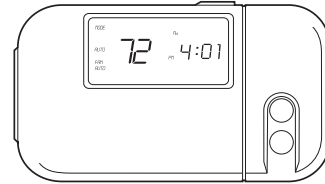

Fig. 13 — Thermostat/Unit Controller

⚠ WARNING

FIRE, EXPLOSION HAZARD

Failure to follow this warning could result in personal injury, death or property damage.

If the main burners fail to light, or the blower fails to come on, shut down gas heating section and call your dealer for service.

TO SHUT UNIT OFF

⚠ WARNING

FIRE, EXPLOSION HAZARD

Failure to follow this warning could result in personal injury, death or property damage.

1. Turn off the gas supply by closing the gas line supply valve. Then, turn off the electrical power supply to the unit by switching the disconnect to off. Install lockout tag before servicing or performing maintenance.
2. Do not turn off the electrical power to unit without first turning off the gas supply.

⚠ CAUTION

Ensure clearances are in accordance with local installation codes, the requirements of the gas supplier and the manufacturer's installation instructions.

⚠ ATTENTION

Assurez-vous que les dégagements sont conformes aux codes d'installation locaux, aux exigences du fournisseur de gaz et aux instructions d'installation du fabricant.

Step 1

Set room thermostat/unit controller heat set point to the lowest temperature setting and set the SYSTEM switch to OFF. See Fig. 14.

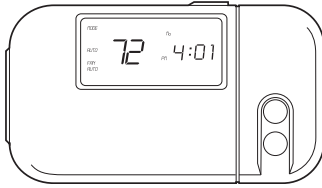

Fig. 14 — Thermostat/Unit Controller

Step 2

Turn off gas supply by closing the gas supply shutoff valve (external to RTU unit). See Fig. 2 or 3 (depending on the size of the unit) for location and see Fig. 15.

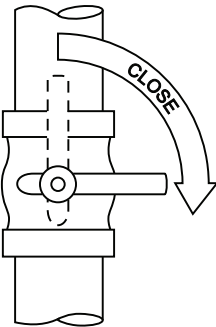

Fig. 15 — Gas Supply Shut Off Valve

Step 3

Turn off the electrical supply to the unit by switching the RTU main disconnect to off. Then, ensure personal safety by installing a lockout tag on the disconnect. See Fig. 16.

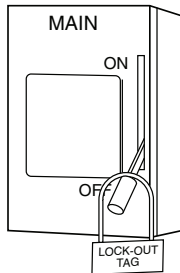

Fig. 16 — RTU Main Disconnect — Electrical Supply

Step 4

Remove the gas component access panel. For location of the gas component access panel, see Fig. 6 or 7 (depending on the size of the unit) and Fig. 17.

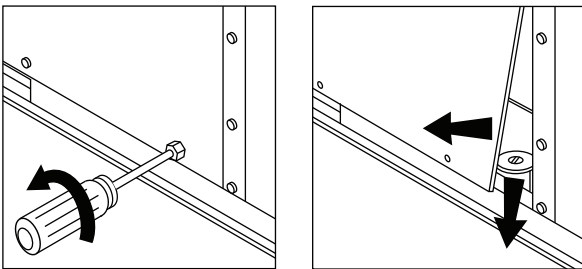

Fig. 17 — Gas Component Access Panel Removal

Step 5

Move the RTU gas valve on/off switch to the OFF position and wait 5 minutes. See Fig. 18.

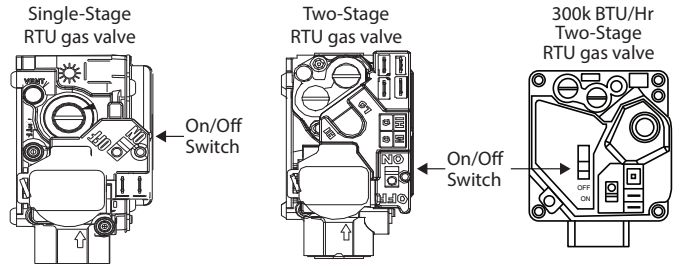

Fig. 18 — Single and Two-Stage Gas Valves

Step 6

Replace the gas component access panel. See Fig. 19.

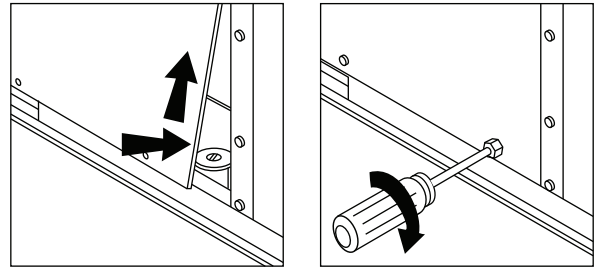

Fig. 19 — Replacing the Gas Component Access Panel

Step 7

If the unit is being shut down because of a malfunction, contact your dealer as soon as possible.

DO NOT proceed to Step 8.

Step 8

If the unit is being shut down because the heating season has ended, remove the disconnect lockout tag and restore electrical power to the unit by switching the RTU main disconnect to ON and then set thermostat/unit controller to the COOL position to ensure operation of the cooling system during the cooling season. See Fig. 20.

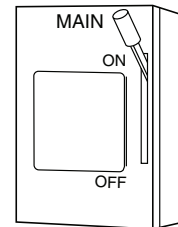

Fig. 20 — RTU Main Disconnect — Electrical Supply

ROUTINE MAINTENANCE AND CARE FOR THE EQUIPMENT OWNER

While some maintenance can be performed by laymen, most should be performed by skilled, experienced personnel. Follow the recommended service maintenance schedule, and modify it as necessary for your application/environment. For instance, dusty areas may require more frequent filter changes. After performing any maintenance or service on the unit, be sure all panels are securely fastened in place to prevent rain from entering unit cabinet and to prevent disruption of the correct unit airflow pattern.

To ensure proper functioning of the unit, flow of combustion and ventilating air must not be obstructed from reaching the unit. Follow service and performance clearances as listed in the product data.

Consider the following information before maintaining or servicing equipment:

Compressor

All compressors are factory supplied with a normal charge of the correct type refrigeration-grade oil in them and should not require additional oil.

Indoor Air Filter(s)

WARNING

FIRE AND EQUIPMENT DAMAGE HAZARD

Failure to follow this warning could result in personal injury and damage to equipment.

Never operate unit without filters in place. The accumulation of dirt, dust or lint on the internal parts of your unit can cause fire or a loss of efficiency. Damage to the blower motor and/or compressors could also result.

Indoor air filter(s) should be checked every 3 or 4 weeks (application dependent) and changed or cleaned when necessary. See Tables 1 and 2 for replacement filter dimensions. See Fig. 21-23 (depending on the size of the unit) for air filter access panel location.

Table 1 — Replacement Filters Size and Quantity, Carrier and Bryant^a

SIZE	CAPACITY (tons)	48TC/580J	48HC/581J	48KC/582J	48FC/582K	48GC/581K	48JC	48LC
04	3	—	16 x 25 x 2 (2)	16 x 25 x 2 (2)	16 x 25 x 2 (2)	16 x 25 x 2 (2)	16 x 16 x 2 (4)	16 x 25 x 2 (2)
05	4	—	16 x 16 x 2 (4)	16 x 25 x 2 (2)	16 x 25 x 2 (2)	16 x 25 x 2 (2)	16 x 16 x 2 (4)	16 x 16 x 2 (4)
06	5	—	16 x 16 x 2 (4)	16 x 16 x 2 (4)	16 x 25 x 2 (2)	16 x 16 x 2 (4)	16 x 16 x 2 (4)	16 x 16 x 2 (4)
07	6	16 x 16 x 2 (4)	16 x 20 x 2 (4)	—	16 x 16 x 2 (4)	16 x 20 x 2 (4)	—	16 x 20 x 2 (4)
08	7-1/2	16 x 20 x 2 (4)	20 x 20 x 2 (4)	—	16 x 20 x 2 (4)	20 x 20 x 2 (4)	—	20 x 20 x 2 (4)
09	8-1/2	20 x 20 x 2 (4)	20 x 20 x 2 (4)	—	20 x 20 x 2 (4)	20 x 20 x 2 (4)	—	20 x 20 x 2 (4)
11	10	—	20 x 20 x 2 (4)	—	—	20 x 20 x 2 (4)	—	—
12	10	20 x 20 x 2 (4)	20 x 20 x 2 (4)	—	20 x 20 x 2 (4)	20 x 20 x 2 (4)	—	20 x 20 x 2 (4)
14	12-1/2	20 x 20 x 2 (4)	18 x 24 x 2 (6)	—	20 x 20 x 2 (4)	18 x 24 x 2 (6)	—	18 x 24 x 2 (6)
16	15	18 x 24 x 2 (6)	—	—	18 x 24 x 2 (6)	—	—	—
17	15	20 x 25 x 2 (6)	20 x 25 x 2 (6)	—	20 x 25 x 2 (6)	20 x 25 x 2 (6)	—	20 x 25 x 2 (6)
18	15	20 x 25 x 2 (6)	—	—	20 x 25 x 2 (6)	—	—	—
20	17-1/2	20 x 25 x 2 (6)	20 x 25 x 2 (6)	—	20 x 25 x 2 (6)	20 x 25 x 2 (6)	—	20 x 25 x 2 (6)
21	17-1/2	20 x 25 x 2 (6)	—	—	20 x 25 x 2 (6)	—	—	—
24	20	—	16 x 25 x 2 (9)	—	20 x 25 x 2 (6)	16 x 25 x 2 (9)	—	16 x 25 x 2 (9)
25	20	16 x 25 x 2 (9)	—	—	16 x 25 x 2 (9)	—	—	—
28	25	16 x 25 x 2 (9)	16 x 25 x 2 (9)	—	16 x 25 x 2 (9)	16 x 25 x 2 (9)	—	16 x 25 x 2 (9)
29	25	16 x 25 x 2 (9)	—	—	16 x 25 x 2 (9)	—	—	—
30	27-1/2	16 x 25 x 2 (9)	—	—	16 x 25 x 2 (9)	—	—	—

NOTE(S):

a. Filter sizes in Table 1 are in inches. Numbers in () denote filter quantity.

Table 2 — Replacement Filters Size and Quantity, ICP^a

SIZE	CAPACITY (tons)	RGS Series	RGH Series	RGX Series	RGV Series	RGW Series
036/037	3	—	16 x 25 x 2 (2)	16 x 25 x 2 (2)	16 x 25 x 2 (2)	16 x 25 x 2 (2)
048/049	4	—	16 x 16 x 2 (4)	16 x 25 x 2 (2)	16 x 25 x 2 (2)	16 x 25 x 2 (2)
060/061	5	—	16 x 16 x 2 (4)	16 x 16 x 2 (4)	16 x 25 x 2 (2)	16 x 16 x 2 (4)
072	6	16 x 16 x 2 (4)	16 x 20 x 2 (4)	—	16 x 16 x 2 (4)	16 x 20 x 2 (4)
090/091	7-1/2	16 x 20 x 2 (4)	20 x 20 x 2 (4)	—	16 x 20 x 2 (4)	20 x 20 x 2 (4)
101	8-1/2	20 x 20 x 2 (4)	20 x 20 x 2 (4)	—	20 x 20 x 2 (4)	20 x 20 x 2 (4)
110/121	10	20 x 20 x 2 (4)	20 x 20 x 2 (4)	—	20 x 20 x 2 (4)	20 x 20 x 2 (4)
150	12-1/2	20 x 20 x 2 (4)	20 x 20 x 2 (4)	—	20 x 20 x 2 (4)	20 x 20 x 2 (4)
210	17-1/2	20 x 25 x 2 (6)	18 x 24 x 2 (6)	—	20 x 25 x 2 (6)	18 x 24 x 2 (6)
240	20	20 x 25 x 2 (6)	20 x 25 x 2 (6)	—	20 x 25 x 2 (6)	20 x 25 x 2 (6)
300	25	16 x 25 x 2 (9)	16 x 25 x 2 (9)	—	16 x 25 x 2 (9)	16 x 25 x 2 (9)
336	27-1/2	16 x 25 x 2 (9)	—	—	16 x 25 x 2 (9)	—

NOTE(S):

a. Filter sizes in Table 1 are in inches. Numbers in () denote filter quantity.

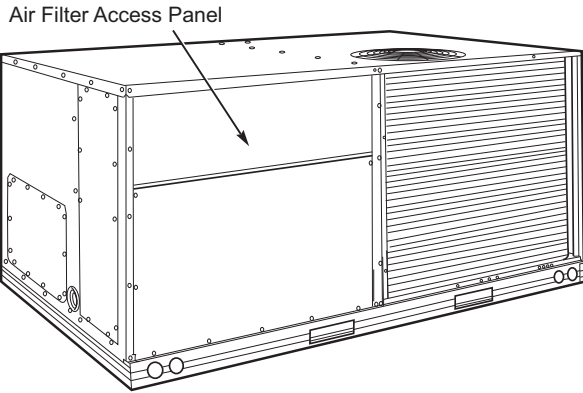

**Fig. 21 — Air Filter Access Panel —
3 to 12-1/2 Ton Units**

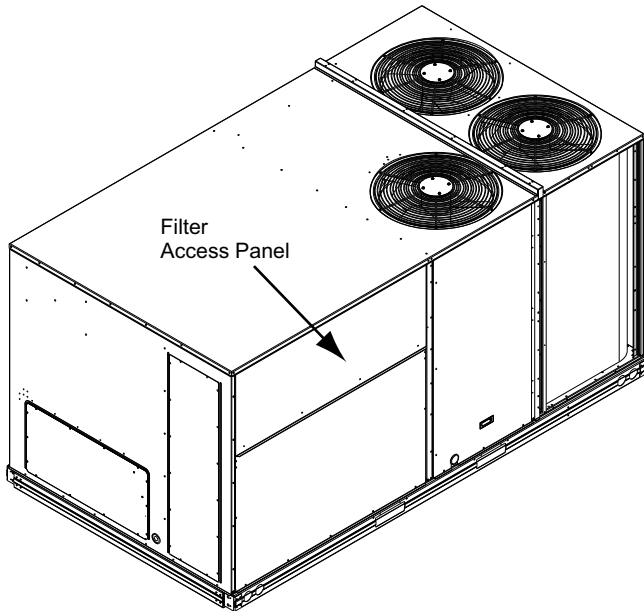

**Fig. 22 — Air Filter Access Panel —
12-1/2 to 15 Ton Units**

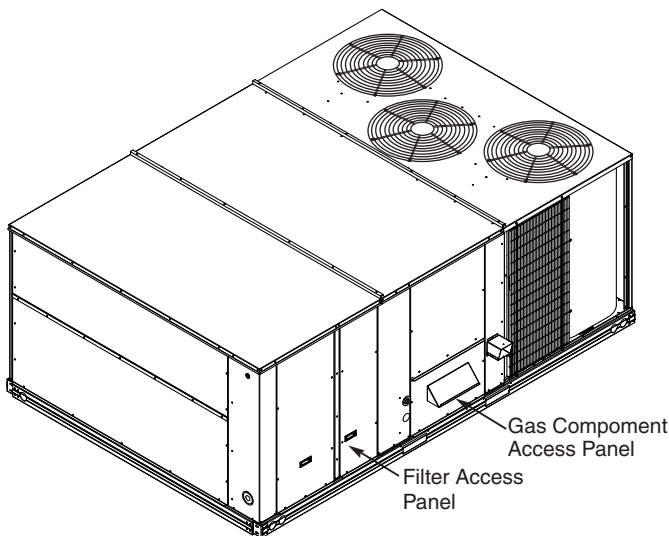

Fig. 23 — Air Filter Access Panel — 15 to 27-1/2 Ton Units

1. Lift up and remove air filter access panel (3 to 15 ton units, see Fig. 21 or 22) or remove the screws securing the filter access panel (15 to 27-1/2 ton units, see Fig. 23).
2. While holding filters, tilt upper filter rack.
3. Remove filters by pulling up and out toward you from the track.
4. Inspect filters. Clean or replace as necessary.
5. Follow direction of airflow arrows as noted on filter frame when returning filters to rack.
6. Reinstall air filter access panel.

If you have difficulty in locating your air filter or if you have questions concerning proper filter maintenance, contact your dealer for instructions. When replacing your unit filters, always use the same size and type of filter that was originally supplied by the installer.

Units with outdoor air capability have a cleanable filter for the outdoor air. This filter should be checked semi-annually and cleaned as necessary with steam or hot water and a mild detergent. Do not use throwaway filters in place of cleanable filters.

Condenser Fan

⚠ WARNING

PERSONAL INJURY HAZARD

Failure to follow this warning could result in personal injury.

Do not poke sticks, screwdrivers, or other objects into revolving fan blades.

Electrical Controls and Wiring

Ensure wires do not contact refrigerant tubing or sharp edges. Electrical controls are difficult to check without proper instrumentation. If inadequate cooling is suspected, contact your qualified local dealer for service.

Combustion Area and Vent System

The combustion area and vent system should be visually inspected before each heating season.

⚠ WARNING

FIRE HAZARD

Failure to follow this warning could result in personal injury and damage to equipment.

If your unit makes any unusual or especially loud noises during heating, shut down the heating section and call your qualified service technician.

Proceed as follows to inspect the combustion area and power-venting system of your unit.

1. Turn off gas supply to your unit.
2. Turn off electrical power to your unit; install lockout tag.
3. Remove gas component access panel.
4. Using a flashlight, carefully inspect the burner areas for dirt, soot, or scale.

⚠ CAUTION

EQUIPMENT DAMAGE HAZARD

Failure to follow this caution may result in damage to equipment.

If dirt, soot, rust or scale accumulations are found, call your service technician and do not operate your heating section.

5. When you have completed your inspection, follow the start-up procedures in this manual to restore your unit to operation.

⚠ WARNING

PERSONAL INJURY HAZARD

Failure to follow this warning could result in personal injury. Components in heat section may be hot after unit has started up. When observing flame, be careful not to get close to or touch heating components.

- 6. Observe unit heating operation. Watch the burner flame to see if it is bright blue. If you observe a suspected malfunction or that the burner flame is not bright blue, shut down the unit and call your dealer.
- 7. Replace gas component access panel.

Integrated Gas Controller (IGC)

The IGC board incorporates an LED that emits a flashing light to indicate an alarm code. If the furnace section will not operate and the LED is flashing a code (1 to 9 flashes in succession), contact your dealer and request service.

NOTE: Make note of the flash code before powering off the unit. The alarm codes clear after power cycle.

Unit Panels

After performing any maintenance or service on the unit, be sure all panels are securely fastened in place to prevent rain from entering unit cabinet and to prevent disruption of the correct unit air-flow pattern.

BEFORE YOU CALL FOR SERVICE, CHECK FOR PROBLEMS THAT CAN BE EASILY SOLVED

If insufficient heating or cooling is suspected:

() Check for sufficient airflow. Check the air filter for dirt. Check for blocked return-air or supply-air grilles. Be sure they are open and unobstructed. If these checks do not reveal the cause, call your servicing dealer.

If your unit is not operating at all, check the following list for easy solutions:

() Check to be sure that your thermostat/unit controller temperature selector is set above the indoor temperature during the heating season, or below the indoor temperature during the cooling season. Be sure the SYSTEM switch in the proper HEAT or COOL position and not in the OFF position.

() Is the electrical supply switch ON? Are any fuses blown, or has the circuit breaker tripped?

() During the heating season, check the external manual shutoff valve. Is this lever parallel with the pipe, indicating that the valve is open? Or is the lever at the right angle, indicating that the valve is closed? If closed, has the gas been shut off for safety reasons? Otherwise, you may open the valve and follow the start-up procedures listed in this manual.

NOTE: Before proceeding with the next check, turn OFF the electrical power supply to the unit. Remove the gas component access panel.

() During the heating season, check the control switch on the gas valve. Is it in the ON position? If it is not, be sure it has not been turned off for the purpose of safety. If no safety hazards are present, follow the start-up procedures in this manual.

If your unit still fails to operate, call your servicing dealer for troubleshooting and repairs. Specify the model and serial numbers of your unit. (Record them in this manual in the space provided.) If the dealer knows exactly which unit you have, he may be able to offer suggestions over the phone, or save valuable time through knowledgeable preparation for the service call.

IN CASE OF TROUBLE

If, after performing the above checks, unit performance is unsatisfactory, shut off the unit and call your dealer.

Dealer's Name _____

Telephone No. _____

Unit Model _____

Unit Serial Number _____

REGULAR DEALER MAINTENANCE

Heat Exchanger

NOTE: To ensure dependable and efficient heating operation, the heat exchanger should be checked by a qualified maintenance person before each heating season, and cleaned when necessary.

⚠ CAUTION

EQUIPMENT DAMAGE HAZARD

Failure to follow this caution may result in damage to equipment.

This checkout should not be attempted by anyone not having the required expertise and equipment to do the job properly.

Checking and/or cleaning the heat exchanger involves removing the gas controls assembly and the flue collector box cover. When finished, the gas controls must be reinstalled for proper operation. Also, the flue collector box cover must be replaced correctly so that a proper seal is maintained. Contact your dealer for the required periodic maintenance. At the beginning of each cooling/heating season and as conditions require.

Fans and Belts, and Fan Motor

Check quarterly the condition of fan wheels and housings, belt tension and fan motor shaft bearings. No lubrication of condenser or evaporator fan bearings or motors is required or recommended.

Evaporator and Condenser Coils

Cleaning of the coils should be done by qualified service personnel. This procedure should be performed prior to cooling operation or more frequently should conditions require. Contact your dealer for the required annual maintenance.

Condensate Drain

The drain pan and condensate drain line should be checked and cleaned at the same time the cooling coils are checked by your dealer.

In addition to the type of routine maintenance you might be willing to perform, your unit should be inspected regularly by a properly trained and qualified service technician. An inspection (preferably each heating/cooling season, but at least every year) should include the following:

- Inspection of all flue product passages, including the burners, heat exchanger, and flue collector box.
- Inspection of all combustion and ventilation-air passages and openings.
- Close inspection of all gas pipes leading to and inside your unit.
- Inspection and if required, cleaning of the condenser and evaporator coils.
- Inspection, and if required, cleaning of the condensate drain pan.
- Inspection and cleaning of blower wheel housing and motor.

- Inspection of all supply and return-air ducts for leaks, obstructions, and insulation integrity. Any problems found should be resolved at the time of inspection.
- Inspection of the unit base for cracks, gaps, etc., which may cause a hazardous condition.
- Inspection of the unit casing for signs of deterioration.
- Inspection of all electrical wiring and components to ensure proper connection.
- Inspection for leaks in the refrigerant circuit. Pressure check to determine appropriate refrigerant charge.
- Inspection of fan wheels and housings, belt tension, and fan motor shaft bearings.
- Operational check of the unit to determine working conditions. Repair or adjustment should be made at the time of inspection.

Your servicing dealer may offer an economical service contract that covers seasonal inspections. Ask for further details.

Complete service instructions can be found in the unit's Service and Maintenance Instructions.

