

i-Vu® Express

Installation and Start-up Guide





Verify that you have the most current version of this document from www.hvacpartners.com, the **Carrier Partner Community** website, or your local Carrier office.

Important changes are listed in **Document revision history** at the end of this document.

Carrier© 2025. All rights reserved.

The content of this guide is furnished for informational use only and is subject to change without notice. Carrier assumes no responsibility or liability for any errors or inaccuracies that may appear in the informational content contained in this guide.



Contents

| | |
|---|-----------|
| What is the i-Vu® Express application? | 1 |
| i-Vu® Express web server specifications | 2 |
| i-Vu® Express tools | 3 |
| Setting up i-Vu® Express client devices and web browsers | 4 |
| Setting up and using a computer with the i-Vu® Express system | 5 |
| Setting up and using a web browser to view the i-Vu® Express interface | 5 |
| To set up and use Microsoft Edge | 5 |
| To set up and use Mozilla Firefox | 6 |
| To set up and use Google Chrome | 7 |
| To set up and use Safari | 8 |
| Before starting the i-Vu® Express application and your system | 10 |
| Configure i-Vu® Express IP addresses | 10 |
| Install device managers and routers | 10 |
| Use Network Service Tool V to ensure hardware is communicating on the CCN network | 11 |
| Get your systems ready | 12 |
| Starting up an i-Vu® Express web server | 13 |
| Optional: Mount the web server to a flat panel display | 13 |
| Connect and power up web server | 14 |
| If starting a new system | 17 |
| Access the startup screen | 17 |
| Optional: Configure the i-Vu® Express system using static IP addresses | 19 |
| Set up login and passwords for an additional user | 19 |
| Set up operators | 20 |
| Set NTP (Network Time Protocol) | 23 |
| Update the i-Vu® Express web server | 24 |
| If upgrading from an i-Vu® Standard or Plus system | 26 |
| Upgrading a single system to the i-Vu® Express application | 26 |
| Capture current i-Vu® Standard or Plus web server settings | 26 |
| Back up data from i-Vu® Standard or Plus Management Tool | 27 |
| Access the startup screen | 28 |
| Optional: Configure the i-Vu® Express system using static IP addresses | 28 |
| Restore data from backup | 29 |
| Restore Addressing | 29 |
| Set NTP (Network Time Protocol) | 29 |
| Update the i-Vu® Express web server | 30 |
| Update your routers and controllers | 32 |
| Merging a mixed CCN and Open system to the i-Vu® Express application | 33 |
| Example of merging i-Vu® Standard or Plus databases to i-Vu® Express | 34 |
| Capture current i-Vu® Standard or Plus web server settings | 35 |
| Backup data from i-Vu® Standard or Plus Management Tool | 37 |
| Install i-Vu® software | 38 |
| Restore data from backups | 39 |
| Troubleshoot, import secondary database, and resolve conflicts | 39 |
| Update your routers and controllers | 40 |
| After the upgrade | 41 |
| Troubleshooting | 42 |
| If unable to access the i-Vu® Express web server in web browser | 42 |
| Example 1: Determining if a valid Ethernet connection exists | 43 |
| Example 2: Pinging by computer name | 44 |
| Connect a monitor directly to the i-Vu® Express web server | 44 |

| | |
|---|-----------|
| System Management | 45 |
| Using the Management Tool | 45 |
| Backup data from i-Vu® Express Management Tool | 48 |
| Restore data from backup | 48 |
| Restore factory defaults | 49 |
| Synchronize to system time | 49 |
| Advanced topics..... | 50 |
| i-Vu® Express network connection options and requirements | 50 |
| If DHCP will not assign two IP addresses | 51 |
| Finding the MAC address of the i-Vu® Express web server | 52 |
| Using TCP/UDP ports | 53 |
| Document revision history | 54 |



What is the i-Vu® Express application?

An i-Vu® Express system is a web-based building automation system that can be accessed from anywhere in the world through a web browser, without the need for special software on the workstation. Through the web browser, you can perform building management functions such as:

- adjust setpoints and other control parameters
- set and change schedules
- graphically trend important building conditions
- view and acknowledge alarms
- run preconfigured and custom reports on energy usage, occupant overrides, and much more

| | |
|--------------------------------------|---|
| Part number | CIV-OPNEXP |
| Networks supported | BACnet and CCN |
| Routing devices | <ul style="list-style-type: none">• USB-CCN Adapter• USB-MS/TP Adapter• Open/CCN Routers• Open/CCN Links• Carrier® ChillerVu™• i-Vu® XT Router and Link• TruVu™ routers |
| Maximum controllers supported | 750 |
| Trend storage | 62 days |
| Alarms storage | 500 |
| Audit Log storage | 30 days |
| Custom Equipment and Trend Reports | |
| Tenant Override Billing Reports | |
| Weather Add-on* | |
| Web Services (XML/SOAP) Data Access | |
| BACnet/Modbus®/LonWorks® integration | |

*Licensed edition is not supported.

i-Vu® Express web server specifications

| i-Vu® web server UBX-110 | |
|-------------------------------------|--|
| Operating temperature | 32°F to 104°F (0°C to 40°C). For indoor use only |
| Storage temperature | -4°F to 140°F (-20°C to 60°C) |
| Storage humidity | 5% to 95% RH |
| Weight | 2.1 lb (0.94 kg) |
| Dimensions | 5.56 in. (141 mm) deep x 7.19 in. (182.50 mm) wide x 1.38 in. (35 mm) high |
| USB Type A ports | 4 USB Type A ports for i-Vu® CCN/BACnet network connections |
| LAN ports | LAN1: Intel® i219; 10/100/1000 Mbps for Ethernet LAN2: Intel® i225; up to 2.5 Gbps for Ethernet |
| Display ports | 2 HDMI ports 1 VGA port 1 USB Type C port |
| Antenna ports | 2 antenna ports — currently not used |
| Wi-Fi antennas | 2 antennas — currently not used |
| Safety Compliance | UL, CB, CCC, BSMI |
| Environmental Compliance | RoHS R33138, WEEE, China RoHS |
| EMC Compliance | CE, FCC, CCC, BSMI, RED |
| i-Vu® web server NUC10I5FNHN | |
| Operating temperature | 32°F to 104°F (0°C to 40°C). For indoor use only |
| Storage temperature | -4°F to 104°F (-20°C to 40°C) |
| Storage humidity | 5% to 90% RH |
| Weight | 2.4 lb (1.09 kg) |
| Dimensions | 4.52 in. (115 mm) deep x 4.37 in. (111 mm) wide x 1.9 in. (48.7 mm) high |
| USB ports | 3 USB Type A ports for i-Vu® CCN/BACnet network connections 2 USB Type C ports — currently not used |
| LAN port | Integrated Intel® 10/100/1000 Mbps port for Ethernet |
| SD card port | 1 SDXC slot — currently not used |
| Display port | 1 HDMI port to connect to a monitor for troubleshooting |
| VESA mounting plate | Attach the web server to the back of a flat monitor |
| Safety Compliance | IEC, UL, EN, CAN/CSA |
| Environmental Compliance | RoHS 2011/65/EU, WEEE 2002/96/EC, China RoHS MII Order #39 |
| EMC Compliance | FCC CFR Title 47, Chapter I, Part 15, Subparts A, B |

i-Vu® Express tools

The following i-Vu® Express tools are for the Installer only.

NOTE The i-Vu® Express tools have a built-in license that expires 2 years after the software is released. Check the Carrier Partner Community Portal or the HVACPartners website for updates concerning your license.

| Use... | To... |
|----------------------------------|--|
| ViewBuilder | Develop and configure graphics and a system database |
| EquipmentBuilder | Build or edit control programs (.equipment files) for programmable controllers. Can also produce graphics, sequence of operation, and screen files |
| Alarm Notification | Receive a message on any networked computer that is running the i-Vu® Express Alarm Notification Client application |
| Virtual BACview® | View and change property values and the controller's real time clock in Open controllers that have a BACview file |
| BBMD Configuration Tool | Configure BACnet/IP Broadcast Management Devices (BBMDs) NOTE If your system has multiple routers that reside on different IP subnets, you must set up one router on each IP subnet as a BACnet/IP Broadcast Management Device (BBMD). |
| MSTP Capture Utility | Capture BACnet traffic on MS/TP. It is intended for situations where Carrier Control Systems Support needs a network capture to troubleshoot communications. |
| Test & Balance | <ul style="list-style-type: none"> • Calibrate airflow in a VAV Zone, VVT Zone, or TV-VAVB3-E2 controller • Calibrate the static pressure in a VVT Bypass or TV-VVTBP-E2 controller • Commission air terminals • Override reheat and terminal fans <p>NOTE Use Test & Balance to manipulate the controllers associated with an air source, but not the air source itself, or heating and cooling equipment, such as chillers and boilers.</p> |
| Snap | Build custom control programs using individual blocks of programming code called microblocks |
| LonWorks Integration Tool | Generate the microblock addresses automatically for third-party LonWorks points |
| AppLoader | Use to download .clipping files to restore factory defaults and check Module Status (Modstat) through the Rnet port or the Service Port on TruVu™ controllers |
| Field Assistant | Service or start up and commission a piece of equipment or a network of controllers. |

Setting up i-Vu® Express client devices and web browsers

The i-Vu® Express system can be viewed on the following client devices and web browsers.

Computers

The client computer should have at least:

- Quad core processor
- 4 GB RAM
- Communications link of 100 Mbps or higher

The i-Vu® Express application will work with slower computers and slower links, but the results may not be satisfactory.

| A computer with this operating system... | Supports these web browsers... |
|--|---|
| Windows® | Google™ Chrome™ v84.0 or later ¹ Microsoft® Edge v84 or later Mozilla® Firefox® v79.0 or later |
| Mac® OS X® (Apple® Mac only) | Safari® v11 or later ² Google Chrome v84.0 or later Mozilla Firefox v79.0 or later |

1 Best performance

2 Best performance unless browser is running on a Mac® Mini or a MacBook:



WARNING If machine is running Mountain Lion 10.8x with an integrated Intel HD 400 graphics card, it will experience display issues. Use one of these workarounds for better performance:

- If an additional NVIDIA graphics card is available, manually switch the graphic card setting in MAC® OS X® to use that card.
- If not, use Google™ Chrome™ v84.0 or later.

Mobile devices

| Device type | Platform support |
|-------------|-------------------------|
| Smart phone | Android™, iOS |
| Tablet | Android™, iOS, Surface™ |

NOTE Some functionality may be limited by the capability of the mobile device and operating system.

Setting up and using a computer with the i-Vu® Express system

- Set the monitor's screen resolution to a minimum of 1920 x 1080 with 32-bit color quality
- You may want to disable the computer's navigation sounds.

Mac only

NOTE The instructions below are for a Mac OS X 10.8. Other versions may vary slightly. See your computer's Help if necessary.

| Computer settings | To change setting... |
|---|--|
| Enable right-clicking to see right-click menus: | |
| On a Mac | <ol style="list-style-type: none"> 1 Select System Preferences > Mouse. 2 Click the drop-down list that points to the mouse's right-click button, then select Secondary Button. |
| On a MacBook | <ol style="list-style-type: none"> 1 Select System Preferences > Trackpad. 2 Enable Secondary click. |

The instructions in Help are for a Windows computer. For instructions that include the **Ctrl** key, replace **Ctrl** with **Command**. For example, replace **Ctrl+click** with **Command+click**.

Setting up and using a web browser to view the i-Vu® Express interface

To set up and use Microsoft Edge

The instructions below are for Microsoft® Edge.

| Web browser settings | To set in Microsoft Edge... |
|---|--|
| Do not block cookies | <ol style="list-style-type: none"> 1 Click ... to display the Actions droplist. 2 Select Settings > Site Permissions > Cookies. |
| Disable web browser's pop-up blockers * | <ol style="list-style-type: none"> 1 Click ... to display the Actions droplist. 2 Then select Settings > Site Permissions > Pop-ups and redirects. |
| To... | Do the following... |
| Maximize the web browser window * | Use the minimize/maximize button in the top right corner of the browser window. |

| To... | Do the following... |
|---|--|
| Have 2 different users logged in to the i-Vu® Express system on the same computer * | <ol style="list-style-type: none"> 1 Click ... to display the Actions droplist. 2 Select New Window. |
| Clear browser cache | <ol style="list-style-type: none"> 1 Click ... to display the Actions droplist. 2 Select Settings > Privacy, Search, and Services > Clear browsing data. 3 Click Choose what to clear. 4 Click Clear now. |

* Does not apply to Microsoft Edge on a phone.

To set up and use Mozilla Firefox

NOTES

- The instructions below are for Mozilla® Firefox® v60.0 on a Windows operating system. Other versions may vary slightly. See your web browser's Help if necessary.
- If the menu bar is not visible, right-click on the window's title bar, and then select **Menu bar**.
- If a message appears in the i-Vu® Express interface that includes the checkbox **Prevent this page from creating additional dialogs**, DO NOT check this box.

| Web browser settings | To set in Firefox... |
|------------------------|--|
| Disable Pop-up blocker | <ol style="list-style-type: none"> 1 Click Tools > Options > Privacy & Security. 2 Under Permissions, click Exceptions next to Block pop-up windows. 3 Type <code>http://</code> (or <code>https://</code>) and then the server name or IP address of your system. 4 Click Allow and then Save Changes. |
| Enable JavaScript | <ol style="list-style-type: none"> 1 In the address bar, type <code>about:config</code>, and then press Enter. 2 Click I accept the risk. 3 In the Search bar, type <code>javascript.enabled</code>. 4 If the value field shows true, JavaScript is enabled. If it shows false, right-click javascript:enabled, and then select Toggle. |
| Add-ons Manager | <p>Select Tools > Add-ons > Extensions. On this page, you can enable/disable installed add-ons such as:</p> <ul style="list-style-type: none"> • Adobe® Acrobat® Reader (to view PDF's) • QuickTime Plug-in (to play audible alarms) <p>Only installed Firefox add-ons appear in the list.</p> |



| To... | Do the following... |
|---|---|
| Maximize the web browser window | Press F11 to turn full-screen mode on/off. |
| Clear browser cache | <ol style="list-style-type: none"> 1 Click Tools > Options > Privacy & Security. 2 Under Cookies and Site Data, click Clear Data. 3 Click Clear. |
| Have 2 different users logged in to the i-Vu® Express system on the same computer | Start a new web browser session. Select File > New Private Window . |

To set up and use Google Chrome

NOTES

- The instructions below are for Google™ Chrome™ v66.0. Other versions may vary slightly. See your web browser's Help if necessary.
- If a message appears in the i-Vu® Express interface that includes the checkbox **Prevent this page from creating additional dialogs**, DO NOT check this box.

On a computer

| Web browser settings | To set in Chrome... |
|---------------------------------|--|
| Enable pop-ups | <ol style="list-style-type: none"> 1 Click  on the browser toolbar. 2 Select Settings. 3 Click Advanced at the bottom of the page. 4 Under Privacy and security, click Content settings. 5 Under Pop-ups > Allow, click ADD, and then type http:// (or https://) and then the server name or IP address of your system. |
| To... | Do the following... |
| Clear browser cache | <ol style="list-style-type: none"> 1 Click  on the browser toolbar. 2 Select More tools > Clear browsing data. 3 Select a time range in the drop-down list. 4 Check the types of information that you want to remove. 5 Click CLEAR DATA. |
| Maximize the web browser window | Press F11 on your keyboard to turn full-screen mode on/off. |

| To... | Do the following... |
|---|--|
| Have 2 different users logged in to the i-Vu® Express system on the same computer | Start a new web browser session. Click  , then select New Incognito window . |

On Chrome for Android

NOTE The following settings are based on Android v11 - options may vary with versions.

| Web browser settings | In the Chrome menu... |
|------------------------|---|
| Turn off desktop mode | Uncheck Request desktop site |
| Disable pop-up blocker | Settings > Advanced > Site Settings > uncheck Block pop-ups |
| Enable JavaScript | Settings > Advanced > Site Settings > check Enable JavaScript |
| Enable Cookies | Settings > Advanced > Site Settings > check Accept Cookies |

| To... | In the Chrome menu... |
|---------------------|---|
| Clear browser cache | Settings > Basics > Privacy > CLEAR BROWSING DATA |

To set up and use Safari

NOTES

- The instructions below are for Safari® v11. Other versions may vary slightly. See your web browser's Help if necessary.
- We recommend that you do not run Safari in full-screen mode. If you do, i-Vu® Express pop-ups open full-screen, covering the main application window.

On an Apple® computer (Mac®)

| Web browser settings | To set in Safari... |
|---|---|
| Disable pop-up blocker | Preferences > Security > uncheck Block pop-up windows |
| Enable JavaScript | Preferences > Security > check Enable JavaScript |
| Enable Plug-ins | Preferences > Security > check Enable plug-ins |
| Prevent pop-ups from opening in a new browser tab | Preferences > Tabs > uncheck Command-click opens a link in a new tab |
| Prevent Safari from automatically opening zip files exported from the i-Vu® Express application | Preferences > General > uncheck Open "safe" files after downloading |

| To... | Do the following... |
|---|---|
| Clear browser cache | History > Clear History |
| Have 2 different users logged in to the i-Vu® Express system on the same computer | Start a new web browser session. Select Safari > Private Browsing > File > New window |

On an Apple® iPad

| Web browser settings | To set on the iPad... |
|------------------------|---|
| Disable pop-up blocker | Settings > Safari > set Block pop-ups to Off |
| Enable JavaScript | Settings > Safari > set JavaScript to On |



TIP Re-enable popup blocking on your device when not using our software.

| To... | Do the following... |
|---------------------|--|
| Clear browser cache | Settings > Safari > Clear History |



TIP Re-enable popup blocking on your device when not using our software.

On an Apple® iOS 12.2

| Web browser settings | To set on the iPhone... |
|----------------------|---|
| Enable JavaScript | Settings > Safari > Advanced |

Before starting the i-Vu® Express application and your system

You must complete the following steps BEFORE powering up the i-Vu® Express web server.

Configure i-Vu® Express IP addresses

The i-Vu® Express application is set by default to automatically obtain its IP configuration information using DHCP. If using DHCP, connect both the web server and your computer to a network with a DHCP server OR a DHCP-enabled network router. Ensure the i-Vu® Express server receives 2 unique IP addresses on the same subnet.

If the site requires a static IP address for the i-Vu® Express web server, this information should be provided by the customer and must be assigned to the i-Vu® Express web server in the *Management Tool* (page 45). See *Optional: Configure the i-Vu® Express system using static IP addresses* (page 19).

NOTES

- If you are having problems with a DHCP Server that will not assign two IP addresses to one network card or MAC address, see *If DHCP will not assign two IP addresses* (page 51).
- The i-Vu® Express web server does not support local link addressing.

Install device managers and routers

If you haven't already, download the *Installation and Start-up Guide* for the device managers and/or routers from the Carrier support website.

Make sure you:

- Mount and wire your CCN device manager(s)*, Open, i-Vu XT, or TruVu router(s).
- Wire the ports for communication and set DIP switches.
- Set up IP addressing, including BACnet/IP Broadcast Management Devices (BBMDs).

NOTE If your system has multiple routers that reside on different IP subnets, you must set up 1 router on each IP subnet as a BACnet/IP Broadcast Management Device (BBMD's). See the *BBMD Utility User Guide* for details.

- Configure BACnet device instance and network number for Open routers using PuTTY or Hyperterminal connected to the Rnet or S2 port.
- Configure BACnet device instance and network numbers for i-Vu XT and TruVu routers using an Ethernet cable attached to the router's Service Port. See the individual router's *Installation and Start-up Guide* for details.

*If you have multiple CCN Gateways, you must use the i-Vu® Pro application with the multi-CCN option included with the license.

Use Network Service Tool V to ensure hardware is communicating on the CCN network

- 1 Connect the 3-terminal connector of the Network Service Tool's **USB to CCN Converter** to Port **S1** on the i-Vu® device manager.

| Carrier USB to CCN converter (top CCN Port) | i-Vu® device manager (Port S1) |
|---|--|
| + | Net+ (Pin 1) |
| G | Signal Ground (Pin 5) |
| - | Net- (Pin 2) |

- 2 Launch **Network Service Tool** and connect to the i-Vu® device manager. Each i-Vu® device manager defaults to Gateway functionality and has a CCN address of **0, 1**.



CAUTION Every CCN device must have a unique CCN address on the CCN network! Do not use Bus **0**, Element **238**, as it is automatically assigned to the i-Vu® Express web server.

- 3 Find the device manager at 0,1 using **Address Search** and change the device manager's CCN address as desired.

NOTE We do not recommend leaving a device manager's CCN address at 0,1, because this is the address that it defaults to when formatted.

- 4 Upload the i-Vu® device manager.
- 5 Access the **Service Configuration Table** IP_CONF to enter the following configuration options:

NOTE A static IP address is required, as DHCP is not supported.

- **Host IP Address** - enter the device manager's IP address, provided by the LAN administrator (allowable entries for xxx.xxx.xxx.xxx: xxx is a decimal number between 0 - 255)
- **Subnet Mask** - enter the device manager's IP address, provided by the LAN administrator (allowable entries for xxx.xxx.xxx.xxx: xxx is a decimal number between 0 - 255)
- **Default Gateway** - enter the IP Gateway's IP address, provided by the LAN administrator (typically a router on the Ethernet LAN).

CCN ENET Configuration

Device Type

- Select **0** if this device manager is the Gateway. (**NOTE** Only 1 Gateway is permitted per system.)
- Select **1** if this device manager is the Bridge.

If using the router as a Bridge, enter **CCN/Ethernet Gateway IP** (the IP address of the i-Vu® device manager that is configured as the Gateway). This is the same address that was entered in the **Host IP address** for the CCN Gateway.

NOTE Record the IP address of the Gateway, because you need it to install your i-Vu® Express system.

- 6 Repeat the above steps for every i-Vu® device manager used in the CCN system.

Get your systems ready

CCN

- 1 Have the IP address of the external Gateway, if you are not using the USB CCN Adapter and are not using DHCP addressing.
- 2 Have a list of all of the devices at your job site, along with the name of each device, the bus and element numbers, and their respective locations.
- 3 For a retrofit project, which is already using CCN global and network schedules, you must have a list of all existing CCN schedule numbers, systems using global and network schedules, and all global schedule masters.
- 4 Verify that each device has a unique element number because duplicates will not install correctly.



CAUTION Do not use Bus 0, Element 238. It is automatically assigned to the i-Vu® web server.

BACnet

- 1 Create a list of all of the i-Vu® Open or XT routers and controllers at your job site, with their BACnet Device ID's, IP addresses (where applicable), BACnet network numbers, and the physical location of all devices.
- 2 Verify that every router has a unique address because duplicates will not install correctly.

See i-Vu® Express Help for more information about setting schedules in the i-Vu® Express interface.

Starting up an i-Vu® Express web server

Optional: Mount the web server to a flat panel display

The i-Vu® web server comes with an optional VESA mounting plate and screws. You can mount it directly onto the back of a flat display panel, such as a flat screen TV, monitor, or wall.

⚠ CAUTION We do not recommend VESA mounting for the UBX-110 web server. The web server may overheat.

- 1 Screw the mounting plate to the holes on the back of the display panel.

NOTE The arrow on the plate must be pointing straight up.

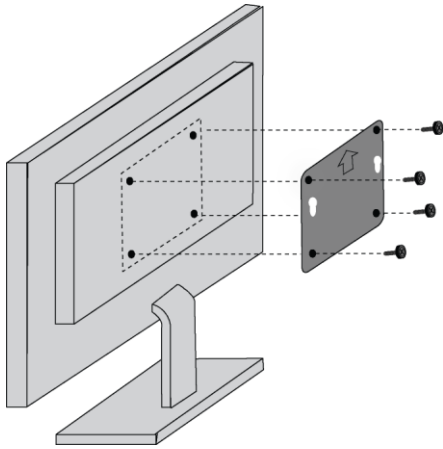

- 2 Insert the stand-off screws into the bottom of the web server.

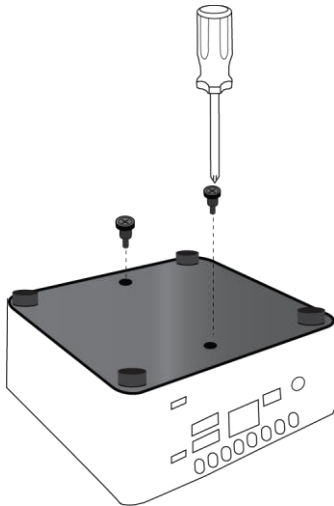

- 3 Insert the extruding stand-off screws into the holes on the mounting plate and slide down into place.

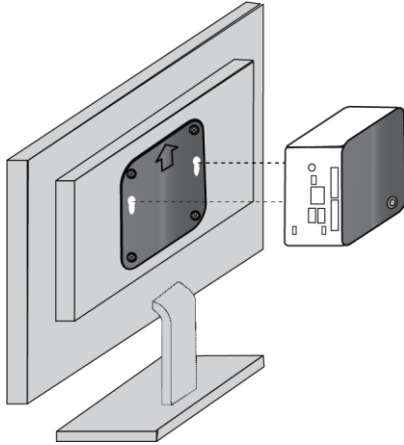

- 4 Follow the instructions for connecting cables and powering the web server.

Connect and power up web server



WARNINGS!

- Do NOT change the BIOS settings in any way or the software will fail.
- Mount your i-Vu® Express web server in an air conditioned space to avoid damage.
- Do NOT open the i-Vu® Express web server! Opening the web server voids your warranty.

- 1 Attach your country's electrical adapter plug onto the power cable.
- 2 Plug the power cable into the i-Vu® Express web server and into an electrical outlet.
NOTE We highly recommend using a UL Certified power surge/RFI suppression device.
- 3 Connect an Ethernet cable from the laptop to the customer's LAN or a DHCP-enabled network router.
- 4 Connect an Ethernet cable from the back of the i-Vu® Express web server to either the customer's LAN or the DHCP-enabled network router that you connected to in step 3.
- 5 If you are using the USB Adapter (CCN or Open) to connect to your network, plug the adapter into any of the USB-A ports and connect to your network. You can only use **one** adapter (CCN or BACnet) on the web server.
- 6 Press the **On/Off** Button to turn on the i-Vu® Express web server.

UBX-110

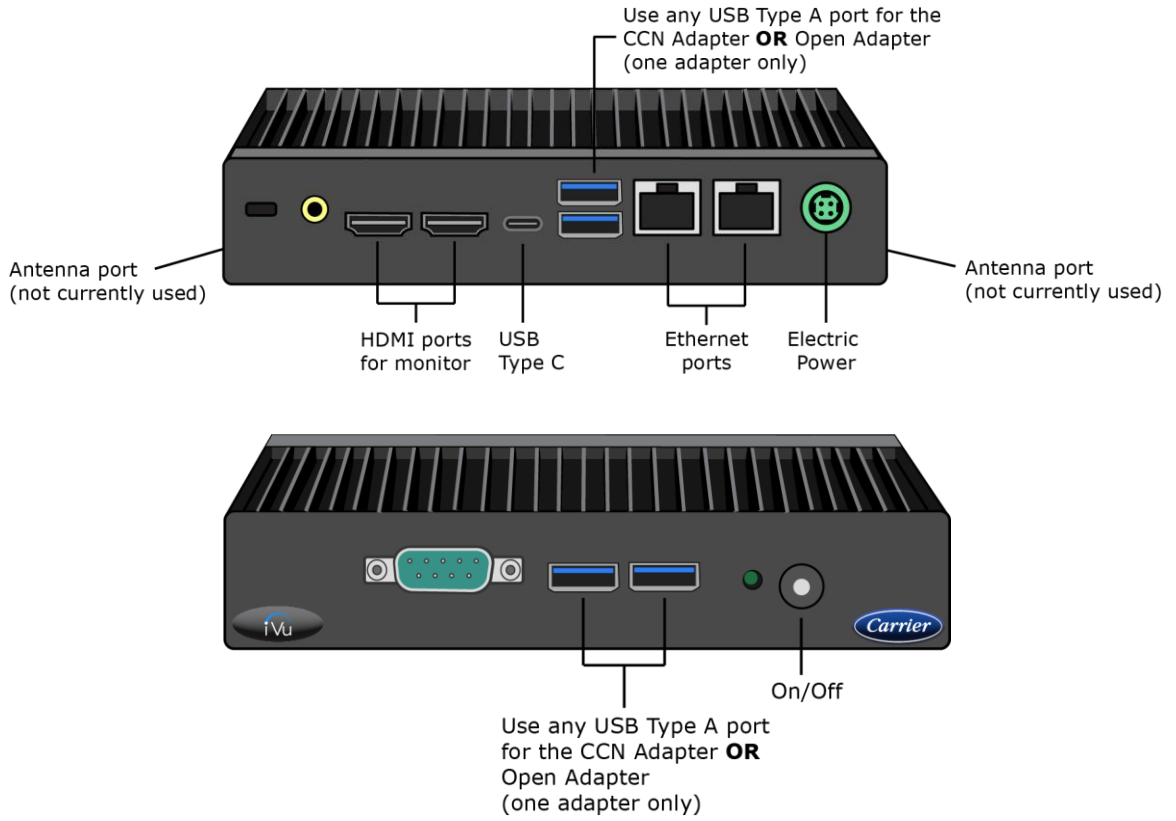

NUC10I5FNHN

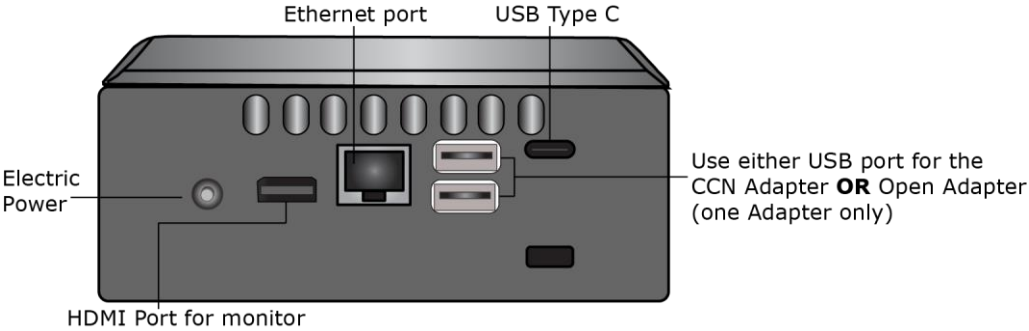
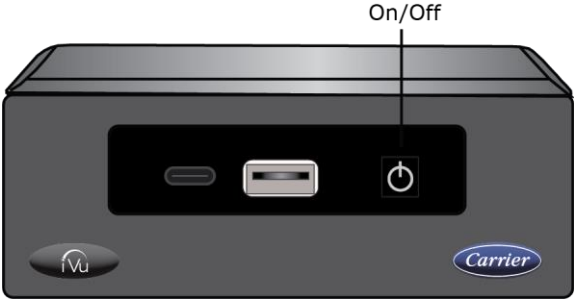

If starting a new system

Access the startup screen

NOTES

- Use only the i-Vu® Express interface to navigate through the i-Vu® Express application; do not use the browser's navigation buttons.
 - Disable all popup blockers.
- 1 Launch the browser and type **https://ivu** or use the server IP address to reach the startup screen. If the i-Vu® Express startup screen does not appear, see *Troubleshooting* (page 42).
 - 2 Accept the terms of the License Agreement and click **Next**.
 - 3 On the start-up screen, fill in all required fields:

Create Installer Account

- **Login Name** — not case sensitive, accepts spaces and special characters
- **Password** — you must enter a password (8 character minimum, no spaces). You cannot leave it blank.

System Settings

Network Name

- Controls the name used to access your system from the Internet or network (LAN)
- Is case sensitive and should not contain special characters or spaces
- If you change the network name from "ivu", make note of the change in the i-Vu® Express Owner's Guide

System Name

- Enter your organization/building name; this becomes the top level in the navigation tree.
- This can be changed later from the Installer view in the **Arrange User View** window.

USB Network Type

- Select the type of network connection you are using. If you are using a USB Adapter, make sure that it is plugged into the web server and that you select the CCN or BACnet option.

If you decide to use a USB CCN or BACnet adapter at a later date, after your system is configured without one:

USB CCN adapter - Requires restoring your system to factory defaults, which results in losing all your system data.

USB BACnet adapter - Your data is not lost, however, you must restart the web server after the adapter is plugged in.

If starting a new system

Regional Settings

- **Timezone, Date** - select appropriate options
- **Time** - enter the correct time! The i-Vu® Express web server will **not** automatically read the time from your computer.

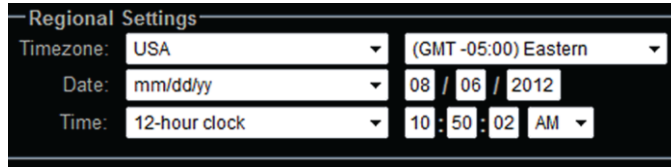

Regional Settings

Timezone: USA (GMT -05:00) Eastern

Date: mm/dd/yy 08 / 06 / 2012

Time: 12-hour clock 10 : 50 : 02 AM

- 4 Click **Next**.
- 5 Review entries. Click **Submit**. Wait for your system to launch. It will take a minute. If you get an error, type `https://<your system name>` in your browser and refresh. Click **Next**.
- 6 After logging into the i-Vu® Express server, access the Management Tool's **Update Management** tab to verify your connection and check for updates. See *Using the Management Tool* (page 45).

When you launch the i-Vu® Express application from your browser, the **Welcome** page provides basic instructions to get started. Refer to Help  in the i-Vu® Express interface for detailed instructions on navigating, finding your routers and controllers, configuring properties, trends, alarms, reports, and much more.

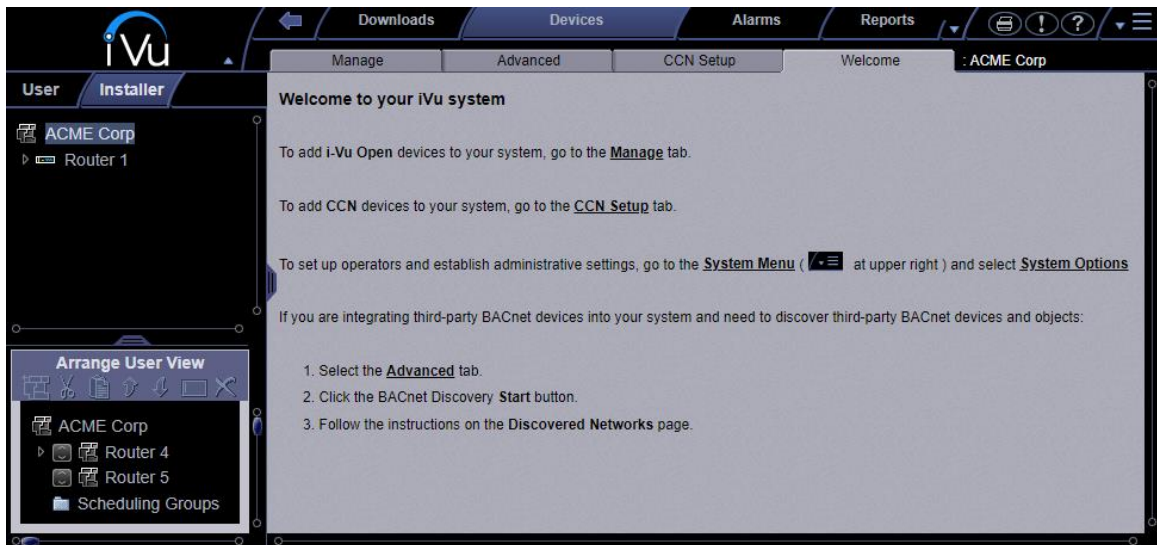

Optional: Configure the i-Vu® Express system using static IP addresses

If you are not using DHCP, you must configure the i-Vu® Express system using static IP addresses.

NOTE You must first connect the i-Vu® Express web server to a network or router that supports DHCP. Once the web server obtains an IP address, you can access the web server and set up static addressing.

- 1 In the i-Vu® Express interface, open the **Management Tool**. Click , then select **System Options > General tab > Management Tool**, or through your browser by typing your system name followed by <hostname>/mgttool. For ex.: https://ivu:<hostname>/mgttool/.

NOTE You need the Installer privilege to access the Management Tool.
- 2 Enter your login and password. See *Using the Management Tool* (page 45) for default credentials.
- 3 On the **Addressing** tab, remove the check by **Obtain an IP address automatically** and enter the **I-Vu Address**, **Subnet Mask**, and **Default Gateway**.
- 4 Enter the **DNS Address**.
- 5 You must enter a fully qualified domain name in the **Domain** field if you want the i-Vu® Express application to be able to email alarms. Otherwise, you can leave the field blank.
- 6 Enter a **USB Network Address**. This must be a valid IP address on the same subnet as the i-Vu® Express address and cannot be 127.0.0.1.
- 7 Click **Apply Changes**.

NOTE If an assigned static IP address is on a different IP subnet than the one assigned by the DHCP network, the connection to the i-Vu® Express web server will be lost. To regain communication with the i-Vu® Express web server, you must configure the IP address of the computer to be on the same subnet.

Set up login and passwords for an additional user

Add new operators and assign an appropriate role to them. You must make a note of this or you could be locked out of your system if no one knows any of the user names and passwords.

We recommend that you

- Assign the **Administrator** role for the main system user.

NOTE For security purposes, do not use `administrator` as the login name.
- Create a user with the **Installer** role, who will be commissioning the system.

NOTE For security purposes, do not use `installer` as the login name.
- Use the chart below or the Help to become familiar with the viewing and editing capabilities of each role.
- Be sure to record the user name and password for the first operator in the i-Vu® Express **Owner's Guide**.
- You cannot leave the password blank for the Tenant Override Billing application.

Set up operators

Select the necessary settings and assign **Roles** (access rights) to set up operators.

NOTES

- You can have up to 10 simultaneous users.
- We highly recommend that only 1 user at a time commission the system.

To add or edit operators, passwords, and roles

- 1 Click , then select **System Options**.
- 2 Select **Operators** tab.
- 3 Click **Add** to enter a new operator, or, select an operator to edit his settings.
- 4 Enter information as needed. The required fields are **Name, Login Name, and Roles**. See table below.
- 5 Click **Accept** or **Apply**.

| Field | Notes |
|---|---|
| Login Name | Must be unique within the system. |
| Force user to change password at login | Forces the operator to change his password immediately after his next login. NOTE You can combine the use of this field and the Change Password field to create a temporary password that the operator must change after his next login. |
| Starting Location | Set the starting location for each individual operator by choosing the specific area or controller in the navigation tree and the starting page from the drop-down menu. |
| Roles | See table below. |

| This privilege... | allows an operator to... |
|-------------------|--|
| Installer | <ul style="list-style-type: none">• Add, edit, and delete operators, operator groups, and privilege sets.• Update the i-Vu® Express system with service packs and patches.• Register the i-Vu® Express software.• Enable and set up the advanced password policy.• Add and remove i-Vu® Express add-ons. |

Access privileges

| Guest | Standard User | Power User | Admin | Installer | The following can be accessed but not edited... |
|-------------------------------------|-------------------------------------|-------------------------------------|-------------------------------------|-------------------------------------|--|
| <input checked="" type="checkbox"/> | <input checked="" type="checkbox"/> | <input checked="" type="checkbox"/> | <input checked="" type="checkbox"/> | <input checked="" type="checkbox"/> | User tree |
| | <input checked="" type="checkbox"/> | <input checked="" type="checkbox"/> | <input checked="" type="checkbox"/> | <input checked="" type="checkbox"/> | Control program tables and Properties pages |
| | <input checked="" type="checkbox"/> | <input checked="" type="checkbox"/> | <input checked="" type="checkbox"/> | <input checked="" type="checkbox"/> | Scheduling Groups pages in the User view navigation tree |
| | | <input checked="" type="checkbox"/> | <input checked="" type="checkbox"/> | <input checked="" type="checkbox"/> | System Options Items |
| <input checked="" type="checkbox"/> | <input checked="" type="checkbox"/> | <input checked="" type="checkbox"/> | <input checked="" type="checkbox"/> | <input checked="" type="checkbox"/> | Alarms |
| | | | | <input checked="" type="checkbox"/> | Logic Pages |

Functional privileges

| Guest | Standard User | Power User | Admin | Installer | The following allows an operator to... |
|-------|-------------------------------------|-------------------------------------|-------------------------------------|-------------------------------------|--|
| | | <input checked="" type="checkbox"/> | <input checked="" type="checkbox"/> | <input checked="" type="checkbox"/> | Manage Alarm Messages and Actions - add, edit, and delete alarm messages and actions. |
| | | | <input checked="" type="checkbox"/> | <input checked="" type="checkbox"/> | Maintain System Parameters - edit all properties on the System Options pages. |
| | <input checked="" type="checkbox"/> | <input checked="" type="checkbox"/> | <input checked="" type="checkbox"/> | <input checked="" type="checkbox"/> | Maintain Schedules - add, edit, delete, and download schedules. |
| | <input checked="" type="checkbox"/> | <input checked="" type="checkbox"/> | <input checked="" type="checkbox"/> | <input checked="" type="checkbox"/> | Maintain Schedule Group Members - add, edit, and delete schedule groups. |
| | | <input checked="" type="checkbox"/> | <input checked="" type="checkbox"/> | <input checked="" type="checkbox"/> | Maintain Categories - add, edit, and delete categories. |
| | | <input checked="" type="checkbox"/> | <input checked="" type="checkbox"/> | <input checked="" type="checkbox"/> | Acknowledge Non-Critical Alarms - acknowledge all non-critical alarms. |
| | | <input checked="" type="checkbox"/> | <input checked="" type="checkbox"/> | <input checked="" type="checkbox"/> | Acknowledge Critical Alarms - acknowledge all critical alarms. |
| | | <input checked="" type="checkbox"/> | <input checked="" type="checkbox"/> | <input checked="" type="checkbox"/> | Force Normal Non-Critical Alarms - force non-critical alarms to return to normal. |
| | | <input checked="" type="checkbox"/> | <input checked="" type="checkbox"/> | <input checked="" type="checkbox"/> | Force Normal Critical Alarms - force critical alarms to return to normal. |
| | | <input checked="" type="checkbox"/> | <input checked="" type="checkbox"/> | <input checked="" type="checkbox"/> | Delete Non-Critical Alarms - delete non-critical alarms. |
| | | <input checked="" type="checkbox"/> | <input checked="" type="checkbox"/> | <input checked="" type="checkbox"/> | Delete Critical Alarms - delete critical alarms. |
| | | | <input checked="" type="checkbox"/> | <input checked="" type="checkbox"/> | Execute Audit Log Report - run the Location Audit Log and System Audit Log reports. |
| | | | <input checked="" type="checkbox"/> | <input checked="" type="checkbox"/> | Download Controllers - mark equipment for download and initiate a download. |
| | | | <input checked="" type="checkbox"/> | <input checked="" type="checkbox"/> | System Shutdown - issue the Shutdown manual command that shuts down i-Vu® Express Server. |

If starting a new system

| Guest | Standard User | Power User | Admin | Installer | The following allows an operator to... |
|-------|-------------------------------------|-------------------------------------|-------------------------------------|-------------------------------------|---|
| | | | | <input checked="" type="checkbox"/> | Access Commissioning Tools: <ul style="list-style-type: none"> • Equipment Checkout • Airflow Configuration • Trend, Report, and Graphic categories that require this privilege • Discovery tool |
| | | <input checked="" type="checkbox"/> | <input checked="" type="checkbox"/> | <input checked="" type="checkbox"/> | Maintain Graphs and Reports - add, edit, and delete trend graphs and reports. |
| | | | <input checked="" type="checkbox"/> | <input checked="" type="checkbox"/> | Remote Data Access-SOAP - retrieve i-Vu® Express data through an Enterprise Data Exchange (SOAP) application. |
| | | | <input checked="" type="checkbox"/> | <input checked="" type="checkbox"/> | Manual Commands/Console Operations - access the manual command dialog box and issue basic manual commands. |
| | | | | <input checked="" type="checkbox"/> | Manual Commands/File IO - execute manual commands that access the server's file system. |
| | | | | <input checked="" type="checkbox"/> | Manual Commands/Adv Network - execute manual commands that directly access network communications. |
| | <input checked="" type="checkbox"/> | <input checked="" type="checkbox"/> | <input checked="" type="checkbox"/> | <input checked="" type="checkbox"/> | Change My Settings - edit preferences on operator's My Settings page. |

Parameter privileges

| Guest | Standard User | Power User | Admin | Installer | The following allows an operator to edit properties such as... |
|-------|-------------------------------------|-------------------------------------|-------------------------------------|-------------------------------------|---|
| | <input checked="" type="checkbox"/> | <input checked="" type="checkbox"/> | <input checked="" type="checkbox"/> | <input checked="" type="checkbox"/> | Setpoint Parameters - occupied and unoccupied heating and cooling setpoints |
| | | | <input checked="" type="checkbox"/> | <input checked="" type="checkbox"/> | Setpoint Tuning Parameters - demand level setpoint offsets, color band offsets, heating and cooling capacities and design temperatures, color hysteresis, and learning adaptive optimal start capacity adjustment values |
| | | <input checked="" type="checkbox"/> | <input checked="" type="checkbox"/> | <input checked="" type="checkbox"/> | Tuning Parameters - gains, limits, trip points, hysteresis, color bandwidths, design temperatures, and optimal start/stop. |
| | | <input checked="" type="checkbox"/> | <input checked="" type="checkbox"/> | <input checked="" type="checkbox"/> | Manual Override Parameters - locks on input, output, and network point. |
| | | <input checked="" type="checkbox"/> | <input checked="" type="checkbox"/> | <input checked="" type="checkbox"/> | Point Setup Parameters - point number, type, range, and network source and destination |
| | | <input checked="" type="checkbox"/> | <input checked="" type="checkbox"/> | <input checked="" type="checkbox"/> | Restricted Parameters - properties the installer restricted with this privilege |
| | | <input checked="" type="checkbox"/> | <input checked="" type="checkbox"/> | <input checked="" type="checkbox"/> | Category Assignments - Alarm, Graphic, Trend, and Report category assignments |

| Guest | Standard User | Power User | Admin | Installer | The following allows an operator to edit properties such as... |
|-------|-------------------------------------|-------------------------------------|-------------------------------------|-------------------------------------|---|
| | | <input checked="" type="checkbox"/> | <input checked="" type="checkbox"/> | <input checked="" type="checkbox"/> | History Value Reset - elapsed active time and history resets, and runtime hours |
| | | <input checked="" type="checkbox"/> | <input checked="" type="checkbox"/> | <input checked="" type="checkbox"/> | Trend Parameters - enable trend logging, log intervals, and log start/stop time. |
| | | <input checked="" type="checkbox"/> | <input checked="" type="checkbox"/> | <input checked="" type="checkbox"/> | Calibration Parameters - point calibration offsets |
| | | <input checked="" type="checkbox"/> | <input checked="" type="checkbox"/> | <input checked="" type="checkbox"/> | Hardware Controller Parameters - module driver properties |
| | | | | | Critical Configuration - critical properties the installer protected with this privilege |
| | | <input checked="" type="checkbox"/> | <input checked="" type="checkbox"/> | <input checked="" type="checkbox"/> | Area Name - area display names |
| | | <input checked="" type="checkbox"/> | <input checked="" type="checkbox"/> | <input checked="" type="checkbox"/> | Control Program Name - equipment display names |
| | | <input checked="" type="checkbox"/> | <input checked="" type="checkbox"/> | <input checked="" type="checkbox"/> | Alarm Configuration - enabling/disabling alarms and editing alarm messages, actions, categories, and templates |
| | | <input checked="" type="checkbox"/> | <input checked="" type="checkbox"/> | <input checked="" type="checkbox"/> | Status Display Tables - tables available under Status |
| | | <input checked="" type="checkbox"/> | <input checked="" type="checkbox"/> | <input checked="" type="checkbox"/> | Maintenance Tables - tables available under Maintenance |
| | | <input checked="" type="checkbox"/> | <input checked="" type="checkbox"/> | <input checked="" type="checkbox"/> | User Config Tables - tables available under User Config |
| | | | | <input checked="" type="checkbox"/> | Service Config Tables - tables available under Service Config |
| | <input checked="" type="checkbox"/> | <input checked="" type="checkbox"/> | <input checked="" type="checkbox"/> | <input checked="" type="checkbox"/> | Setpoint Tables - tables available under Setpoint |
| | <input checked="" type="checkbox"/> | <input checked="" type="checkbox"/> | <input checked="" type="checkbox"/> | <input checked="" type="checkbox"/> | Time Schedule data Tables - tables available under Time Schedule |

Set NTP (Network Time Protocol)

Network Time Protocol (NTP) is a networking protocol for clock synchronization. You can designate an NTP source that sends the correct time to the i-Vu® Express web server, ensuring constant accurate time. You can enter 2 static addresses (DNS name or IP) of NTP servers or use the default addresses provided by the i-Vu® Express application. If you do not enable NTP, the i-Vu® Express system clock must be monitored and updated regularly in **System Options > General** tab.

You can configure DHCP servers to supply IP addresses of NTP servers to the i-Vu® Express web server. If you have checked **Obtain an IP address automatically** on the **Addressing** tab and **Enable Time Synchronization from an NTP server** on the **NTP** tab, the i-Vu® Express web server tries to obtain an NTP server address from the DHCP server on site. If it cannot find one, the i-Vu® Express web server uses the User Assigned NTP addresses, if any, in the User Assigned fields.



CAUTION Contact your Network Administrator for guidance in entering these settings.

If starting a new system

You can access NTP from a local server, a remote server, or a website. To set up NTP:

- 1 Verify that **Enable time synchronization from an NTP server** is checked.
- 2 **User Assigned NTP Server Address** – You can use the default website addresses if your system allows it. Firewalls may prevent successful access to the default websites. Your Network Administrator can provide alternate addresses for a local server, a remote server, or a website.
- 3 Click **Apply Changes** to save your updated settings. The web server automatically reboots.

Update the i-Vu® Express web server

Carrier periodically provides updates that include enhancements, bug fixes, and new SAL files. You can apply these updates in the Management Tool.

The i-Vu® Express SAL files update your i-Vu® Express controllers. The SAL libraries contain control programs, graphics, drivers, screen files, and other important controller data.

The i-Vu® Express web server must be connected to the Internet and be able to access the Balena Cloud in order to receive updates.

NOTES

- The library update only changes **default** graphics. If you have edited your graphic in ViewBuilder, it is not updated.
- The last digits in the SAL library name are the release date of the library.
- All of the SAL files will not necessarily have the same <date> revision.
- To ensure that your installation is running the latest software, check the **Management Tool** for updates.

To check current SAL library version

- 1 Login to the i-Vu® Express application.
- 2 Click , then select **System Options > Update** tab.
- 3 Click **Current Libraries (.sal)** to view the current SAL libraries and their revision date.

Step 1: Apply available updates

- 1 Access the **Management Tool** using one of the following methods:
 - Click , then select **System Options > General tab > Management Tool**.
 - Launch your browser and type the host name followed by /mgttool/. (Ex. <https://ivu/mgttool/>)

NOTE You need the Installer privilege to access the Management Tool.

- 2 In the **Update Management** tab, check if any updates are available. An available update is indicated by an  icon on the tab's title.

NOTE If the **Current version** field is blank, the web server is not connected to the Balena Cloud and cannot receive updates. Check whether the web server can access api.balena-cloud.com by pinging the URL using a computer on the same subnet as the web server. If pinging is unsuccessful, contact the customer IT or ISP.

- 3 Click **Apply** to install and apply the latest update.
- 4 Review the Release Notes following the update to confirm the update.

If the update contains new SAL files, follow these steps to implement the new equipment library:

Step 2: Update the files for the routers and controllers

- 1 On the i-Vu® Express navigation tree, right-click the router or controller to update and select **Driver Properties**.
- 2 Select **Properties** tab > **Update** tab > **Add New Driver** tab.
- 3 If the database contains two or more controllers, select which routers to change:
 - This controller only
 - All controllers on this network that use the current driver version
 - All controllers in the system that use the current driver version
- 4 Click **Update**.
- 5 Click **Save**.

NOTES

- Check **Stage driver in controller** to stage the driver to the controller before installing it. Use this option to avoid interrupting controller function when installing the driver.
- Click **Delete Unused** to delete all unused drivers in <system_name>\drivers.

Step 3: Update the files for CCN controllers

- 1 In the navigation tree, select the CCN device manager associated with the controllers that are to be updated.
- 2 Select **Devices** > **CCN Discovery** and re-scan any controllers that need to be updated by checking **Rescan Controllers Selected Below for Configuration Changes** and clicking **Start Scan**.

Step 4: Apply the update to the routers and controllers

- 1 Select the **System**  in the navigation tree and then select the **Downloads** page.
- 2 If you wish to apply the new SAL file to your entire system, you can use this page to compare to your navigation tree and verify that you have selected all of your routers and controllers for download.

NOTE Only the CCN Gateway and device managers require download, so the CCN controllers/equipment are not listed.
- 3 A network's controllers download in the order shown. To change the order, select a controller(s), then drag and drop or click **Move to Top** or **Move to Bottom**.

EXCEPTION If a controller's router requires a download, it will download first regardless of its position on the Downloads page. Click the **Start** button.

NOTES

- Use **Ctrl+click**, **Shift+click**, or the **Select All** checkbox to select multiple controllers.
- See To download from the Downloads page in Help for more details.

If upgrading from an i-Vu® Standard or Plus system

Prerequisite

Verify that you have the latest version of all the add-ons that are currently used. Some have been updated for the i-Vu® Express application. Be sure to have those updated add-ons ready to install during the upgrade process.

Upgrading a single system to the i-Vu® Express application

The steps below are a quick outline of the upgrade process. Each step is explained in detail in the sections that follow. Note that you must purchase a new web server to accommodate the i-Vu® Express application.

- 1 Capture your current i-Vu® Standard or Plus web server settings.
- 2 Backup your system to your PC from the i-Vu® Standard or Plus Management Tool.
- 3 Restore your system to the i-Vu® Express web server using the **Legacy Restore** option in the Management Tool.
- 4 Check for any available updates from the Management Tool.

NOTES

- If you are running a mixed CCN and Open system, see *Merging a mixed CCN and Open system to the i-Vu® Express application*. (page 33)
- You cannot downgrade an i-Vu® Pro database to the i-Vu® Express application.
- If you are upgrading an i-Vu Standard or Plus v6.0 or older system, follow the upgrade procedure in the *i-Vu Application Upgrade Guide to v7.0* guide before attempting to upgrade to the i-Vu® Express application.

Capture current i-Vu® Standard or Plus web server settings

Access the **Management Tool** using one of the following methods:

- Click , then select **System Options > General tab > Management Tool**.
- Launch your browser and type your system name followed by :8080. For ex.: <http://ivu:8080/>.
- **NOTE** You need the Installer privilege to access the Management Tool.

Print the **Management Tool** screen or record all of the information under **Addressing** and **i-Vu Port Configuration**.

Addressing

Name:

Obtain an IP address automatically

i-Vu Address: . . .

Subnet Mask: . . .

Default Gateway: . . .

DNS Address: . . .

Domain:

USB Network Type: CCN (**Connector Not Detected**)

USB Network Address: . . .

i-Vu Port Configuration

HTTP : HTTPS :

Note: Changing these values forces a webserver restart.

NTP Configuration

Status: Local NTP server is running. Seconds since the last NTP time sync: 292.
Estimated time drift in 1000's of a second: 0.000.

Enable time synchronization from an NTP server

System Assigned NTP Server Address:

System Assigned NTP Server Address:

User Assigned NTP Server Address:

User Assigned NTP Server Address:

Back up data from i-Vu® Standard or Plus Management Tool

Access the **Management Tool** using one of the following methods:

- Click , then select **System Options > General tab > Management Tool**.
- Launch your browser and type your system name followed by :8080. For ex.: <https://ivu:8080/>.

Backup data to your computer

- 1 Click **PC Backup** under **Manage Server Data** to save the entire database zipped into one file to your computer.
- 2 Click **OK** when you see the message **The system will be stopped and restarted. Do you wish to proceed?** Watch **Operation Status** to see the progress.
- 3 Click the message **Save/Download Backup File to Your Local Hard drive** when it appears.
- 4 Click **Save** when asked **Do you want to open or save this file?**
- 5 Save this system.backup.tgz file to a convenient location on your computer.
CAUTION! Do not alter the name of this file!
- 6 Exit from **Management Tool**.

Access the startup screen

NOTES

- Use only the i-Vu® Express interface to navigate through the i-Vu® Express application; do not use the browser's navigation buttons.
 - Disable all popup blockers.
- 1 Launch the browser and type **https://ivu** to reach the startup screen. If the i-Vu® Express startup screen does not appear, see *Troubleshooting* (page 42).
 - 2 Enter login name and password.
 - 3 **Accept** License Agreement.
 - 4 On the start-up page, click **Link to Management Tool** at the bottom of the screen.

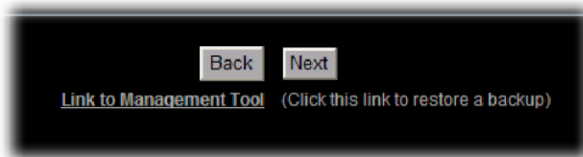

- 5 Access the Management Tool's **Update Management** tab to restore your backup and check for updates. See *Restore data from backup* (page 29).

Optional: Configure the i-Vu® Express system using static IP addresses

If you are not using DHCP, you must configure the i-Vu® Express system using static IP addresses.

NOTE You must first connect the i-Vu® Express web server to a network or router that supports DHCP. Once the web server obtains an IP address, you can access the web server and set up static addressing.

- 1 In the i-Vu® Express interface, open the **Management Tool**. Click , then select **System Options > General tab > Management Tool**, or through your browser by typing your system name followed by <hostname>/mgttool. For ex.: https://ivu:<hostname>/mgttool/.
NOTE You need the Installer privilege to access the Management Tool.
- 2 Enter your login and password. See *Using the Management Tool* (page 45) for default credentials.
- 3 On the **Addressing** tab, remove the check by **Obtain an IP address automatically** and enter the **I-Vu Address**, **Subnet Mask**, and **Default Gateway**.
- 4 Enter the **DNS Address**.
- 5 You must enter a fully qualified domain name in the **Domain** field if you want the i-Vu® Express application to be able to email alarms. Otherwise, you can leave the field blank.
- 6 Enter a **USB Network Address**. This must be a valid IP address on the same subnet as the i-Vu® Express address and cannot be 127.0.0.1.
- 7 Click **Apply Changes**.

NOTE If an assigned static IP address is on a different IP subnet than the one assigned by the DHCP network, the connection to the i-Vu® Express web server will be lost. To regain communication with the i-Vu® Express web server, you must configure the IP address of the computer to be on the same subnet.

Restore data from backup

- 1 Access the **Management Tool** using one of the following methods:
 - Click , then select **System Options > General tab > Management Tool**.
 - Launch your browser and type the host name followed by /mgttool/. (Ex. https://ivu/mgttool/)

NOTE You need the Installer privilege to access the Management Tool.
- 2 In the **Manage System** tab, click **Legacy Restore**.
- 3 Browse to your backup file and click **Perform Restore**.
- 4 Restore is complete when **Operation Status** displays **No Background Operations Currently Active**.
- 5 If you wish to change the name of your i-Vu® Express system from the default **Ivu**, enter the new name in the **Name** field under **Addressing**.

Restore Addressing

Refer to the data recorded from your original i-Vu® Express web server. See *Capture current i-Vu® Express web server settings*. (page 48)

- 1 Enter your previous **Name**.
- 2 If your original setup did not have **Obtain an IP address automatically** checked, then enter **ALL** of the IP address information from the original configuration.
- 3 Click **Apply Changes** to save your updated settings. The web server automatically reboots.

Set NTP (Network Time Protocol)

Network Time Protocol (NTP) is a networking protocol for clock synchronization. You can designate an NTP source that sends the correct time to the i-Vu® Express web server, ensuring constant accurate time. You can enter 2 static addresses (DNS name or IP) of NTP servers or use the default addresses provided by the i-Vu® Express application. If you do not enable NTP, the i-Vu® Express system clock must be monitored and updated regularly in **System Options > General** tab.

You can configure DHCP servers to supply IP addresses of NTP servers to the i-Vu® Express web server. If you have checked **Obtain an IP address automatically** on the **Addressing** tab and **Enable Time Synchronization from an NTP server** on the **NTP** tab, the i-Vu® Express web server tries to obtain an NTP server address from the DHCP server on site. If it cannot find one, the i-Vu® Express web server uses the User Assigned NTP addresses, if any, in the User Assigned fields.



CAUTION Contact your Network Administrator for guidance in entering these settings.

You can access NTP from a local server, a remote server, or a website. To set up NTP:

- 1 Verify that **Enable time synchronization from an NTP server** is checked.
- 2 **User Assigned NTP Server Address** – You can use the default website addresses if your system allows it. Firewalls may prevent successful access to the default websites. Your Network Administrator can provide alternate addresses for a local server, a remote server, or a website.
- 3 Click **Apply Changes** to save your updated settings. The web server automatically reboots.

Update the i-Vu® Express web server

Carrier periodically provides updates that include enhancements, bug fixes, and new SAL files. You can apply these updates in the Management Tool.

The i-Vu® Express SAL files update your i-Vu® Express controllers. The SAL libraries contain control programs, graphics, drivers, screen files, and other important controller data.

The i-Vu® Express web server must be connected to the Internet and be able to access the Balena Cloud in order to receive updates.

NOTES

- The library update only changes **default** graphics. If you have edited your graphic in ViewBuilder, it is not updated.
- The last digits in the SAL library name are the release date of the library.
- All of the SAL files will not necessarily have the same <date> revision.
- To ensure that your installation is running the latest software, check the **Management Tool** for updates.

To check current SAL library version

- 1 Login to the i-Vu® Express application.
- 2 Click , then select **System Options > Update** tab.
- 3 Click **Current Libraries (.sal)** to view the current SAL libraries and their revision date.

Step 1: Apply available updates

- 1 Access the **Management Tool** using one of the following methods:
 - Click , then select **System Options > General tab > Management Tool**.
 - Launch your browser and type the host name followed by /mgttool/. (Ex. https://ivu/mgttool/)

NOTE You need the Installer privilege to access the Management Tool.

- 2 In the **Update Management** tab, check if any updates are available. An available update is indicated by an  icon on the tab's title.

NOTE If the **Current version** field is blank, the web server is not connected to the Balena Cloud and cannot receive updates. Check whether the web server can access api.balena-cloud.com by pinging the URL using a computer on the same subnet as the web server. If pinging is unsuccessful, contact the customer IT or ISP.

- 3 Click **Apply** to install and apply the latest update.
- 4 Review the Release Notes following the update to confirm the update.

If the update contains new SAL files, follow these steps to implement the new equipment library:

Step 2: Update the files for the routers

- 1 Select the router that you wish to update in the navigation tree.
- 2 Right-click and select **Driver Properties**.
- 3 Select **Properties** page > **Update** tab.
- 4 If the database contains two or more routers, you must check **Change for all controllers of this type?** in the **Controller** section.
- 5 Click **Update**. A message appears **Changes the driver and screen file to use the current library version. Continue?**

NOTE If more than one router exists, the additional routers are listed below the **Update** button.

- 6 Click **OK**.
- 7 Click **Accept**.

Step 3: Update the files for the controllers

- 1 Double-click the controller in the navigation tree or right-click and select **Configure**.
- 2 If you have multiple controllers of the same type, enable **Change for all control programs of this type?**
- 3 Click **Update** under **Control Program**. A message appears **Changes the control program, view, driver, and screen file to use the current library version. Continue?**
- 4 Click **OK**. When the message **Updated to the library version xx.** appears, click **Close**.
- 5 Repeat steps 1 - 4 for any additional types of controllers.
- 6 Click **Close** again.

Step 4: Update the files for CCN controllers

- 1 In the navigation tree, select the CCN device manager associated with the controllers that are to be updated.
- 2 Select **Devices > CCN Discovery** and re-scan any controllers that need to be updated by checking **Rescan Controllers Selected Below for Configuration Changes** and clicking **Start Scan**.

Step 5: Apply the update to the routers and controllers

- 1 Select the **System**  in the navigation tree and then select the **Downloads** page.
- 2 If you wish to apply the new SAL file to your entire system, you can use this page to compare to your navigation tree and verify that you have selected all of your routers and controllers for download.
NOTE Only the CCN Gateway and device managers require download, so the CCN controllers/equipment are not listed.
- 3 A network's controllers download in the order shown. To change the order, select a controller(s), then drag and drop or click **Move to Top** or **Move to Bottom**.
EXCEPTION If a controller's router requires a download, it will download first regardless of its position on the Downloads page. Click the **Start** button.

NOTES

- Use **Ctrl+click**, **Shift+click**, or the **Select All** checkbox to select multiple controllers.
- See To download from the Downloads page in Help for more details.

Update your routers and controllers



CAUTION Update your routers and controllers only **once**. Use either the i-Vu® application **or** Field Assistant. Router and controller configurations are maintained when you update them using the procedure below.

Step 1: Update the files for routers and controllers

- 1 On the i-Vu® Express navigation tree, right-click the router or controller to update and select **Driver Properties**.
- 2 Select **Properties** tab > **Update** tab > **Add New Driver** tab.
- 3 If the database contains two or more controllers, select which routers to change:
 - This controller only
 - All controllers on this network that use the current driver version
 - All controllers in the system that use the current driver version
- 4 Click **Update**.
- 5 Click **Save**.

NOTES

- Check **Stage driver in controller** to stage the driver to the controller before installing it. Use this option to avoid interrupting controller function when installing the driver.
- Click **Delete Unused** to delete all unused drivers in <system_name>\drivers.

Step 2: Update the files for CCN controllers

- 1 In the navigation tree, select the CCN device manager associated with the controllers that are to be updated.
- 2 Select **Devices** > **CCN Discovery** and re-scan any controllers that need to be updated by checking **Rescan Controllers Selected Below for Configuration Changes** and clicking **Start Scan**.

Step 3: Apply the update to routers and controllers

- 1 Select the **System**  in the navigation tree and then select the **Downloads** page.
- 2 If you wish to apply the new SAL file to your entire system, you can use this page to compare to your navigation tree and verify that you have selected all of your routers and controllers for download.

NOTE Only the CCN Gateway and device managers require download, so the CCN controllers/equipment are not listed.
- 3 A network's controllers download in the order shown. To change the order, select a controller(s), then drag and drop or click **Move to Top** or **Move to Bottom**.

EXCEPTION If a controller's router requires a download, it will download first regardless of its position on the Downloads page. Click the **Start** button.

NOTES

- Use **Ctrl+click**, **Shift+click**, or the **Select All** checkbox to select multiple controllers.
- See To download from the Downloads page in Help for more details.

Merging a mixed CCN and Open system to the i-Vu® Express application

Use the following instructions to merge a mixed CCN and Open i-Vu® system. You must purchase a new web server to accommodate the i-Vu® Express application.

Terms to know:

- **Restore files** – restores all settings, including database, operators, alarms, and trends
- **Source files** – includes drivers, .equipment, .view, .bacview files, and .touch files
- **Clipping files** –
 - Navigation tree items including attached control programs, graphics, drivers, and screen files
 - Trend data
 - Reports
 - Alarm categories
 - Schedules and schedule group membership (including the entire schedule group and schedules, if it does not exist in the target system)
 - Alarm actions

NOTES

- Does not include operators or alarms
- A clipping containing CCN controllers does not include the CCN tables. When importing a clipping containing CCN devices, you must re-scan the controller in order to see the tables.

NOTE A system clipping file takes time to import. You can see the estimated time for each database in **System Options > General tab > System Statistics**.

- **Primary database** - This is the database that is restored and not added using a clipping. Primary includes database, operators, alarms, and trends. See *Before you start the merge process* below to determine whether the CCN or Open system should be your primary database.

Before you start the merge process:

- The limit for the i-Vu® Express application is 750 devices. If your combined system exceeds 750 devices, you must upgrade to the i-Vu® Pro Unlimited application.
- If you are currently using both a USB CCN and an Open Adapter, you must replace one of them with an external router. The i-Vu® Express application does not support 2 USB cables on the single web server.

NOTE Replace a USB CCN Adapter with an i-Vu® Link or an i-Vu® CCN Router. Replace a USB Open Adapter with an i-Vu® Open Link, i-Vu® Open Router, i-Vu® XT Router, or i-Vu® XT BACnet Link. During the merge process, the i-Vu® application will automatically find the new router and connect it to the network.

- Decide which database will be primary. A system that is connected with a USB Adapter (CCN or Open), must be primary. If you are not using a USB Adapter, select the larger database. The primary system is the first one you restore on the new web server. All settings are restored in your primary database, including, alarms, trends, and operators. The secondary system is installed using a clipping, which does not include operators or alarms.

Example of merging i-Vu® Standard or Plus databases to i-Vu® Express

The following example is an overview of the steps to merge systems. Review this process to become familiar with the concepts. See proceeding topics for specific details on how to execute these steps.

Assumptions in this example

- An i-Vu CCN Plus v4.2 web server system is connected to the network using a USB CCN Adapter
- An i-Vu Open v5.0 or 5.1 system is connected to an i-Vu Open Link or an i-Vu Open Router

See the illustration below for explanations of the terms used in the steps.

Current configuration

i-Vu CCN Standard v4.2

Web server 1 (**WS1**)

Database 1 (**DB1**)

Location 1

Connected to the CCN network using a CCN Adapter cable



i-Vu Open Standard or Plus v5.1

Web server 2 (**WS2**)

Database 2 (**DB2**)

Location 2

Connected to the MS/TP network using an i-Vu Open Link or i-Vu Open Router



End configuration (New web server)

i-Vu Express

Primary database 1 (**DB1**)

Location 1

Connected to the CCN network using a CCN Adapter cable

Connected to the MS/TP network using an i-Vu Open Link, i-Vu Open Router, i-Vu XT Router, i-Vu XT BACnet Link, or TruVu Router



To merge mixed system databases in preparation for installation to a new i-Vu® Express web server

NOTE WS1 is the target web server because it has a USB adapter.

- 1 Capture current web server settings of the server that the i-Vu® Express will replace.
- 2 *Backup DB1 and DB2 from Management Tool to PC* (page 37).
- 3 Install v7.0 on both WS1 and WS2 using a USB drive or CD. See the *i-Vu Application Upgrade Guide to v7.0*.
- 4 *Restore DB1 to WS1 from Management Tool* (page 39).
- 5 *Restore DB2 to WS2 from Management Tool*. (page 39)
- 6 Check number of devices on both systems in **System Options > General tab > Statistics** to ensure your merged system will not have more than 750 devices.
- 7 *Fix potential conflicts between both databases*. (page 39)
 1. Export DB2 Source files from WS2.
 2. Import DB2 Source file into WS1.
 3. Resolve conflicts.
- 8 Export DB2 Clippings from WS2.
- 9 Import DB2 Clippings into WS1.
- 10 Back up the merged database to your PC.

Once you have completed these steps, you can load the database into the new i-Vu® Express server. see *Upgrading a single system to the i-Vu® Express application* (page 26).

NOTE You must configure the i-Vu® Express server with the IP address settings of the i-Vu® Standard or Plus server located where you will install the i-Vu® Express server.

Capture current i-Vu® Standard or Plus web server settings

You need to record the **Addressing** information of both existing servers from the i-Vu® web server Management Tool. Also note which address is for the server that is physically residing where you are going to place the new i-Vu® Express web server.

- If you will be using a USB Adapter (CCN or Open), the new web server needs to be where the cable is located.
- If you have external routers, use the location of the web server that connects to the system you choose for your primary database.
- If you enable **Obtain an IP address automatically**, the only setting you need to record is the **i-Vu Port Configuration**.

Access the **Management Tool** using one of the following methods:

- Click , then select **System Options > General tab > Management Tool**.
- Launch your browser and type your system name followed by :8080. For ex.: http://ivu:8080/.
- **NOTE** You need the Installer privilege to access the Management Tool.

If upgrading from an i-Vu® Standard or Plus system

Print the **Management Tool** screen or record all of the information under **Addressing** and **i-Vu Port Configuration**.

- i-Vu® Standard v4.2 addressing

Addressing

Name:

Obtain an IP address automatically

i-Vu Address: . . .

Subnet Mask: . . .

IP Gateway Address: . . .

DNS Address: . . .

Domain:

CCN Gateway Address: . . .

i-Vu Port Configuration

HTTP : HTTPS :

Note: Changing these values forces a webserver restart.

- i-Vu® Plus v4.2 addressing

Addressing

Name:

Obtain an IP address automatically

i-Vu Address: . . .

Subnet Mask: . . .

IP Gateway Address: . . .

DNS Address: . . .

Domain:

i-Vu Port Configuration

HTTP : HTTPS :

Note: Changing these values forces a webserver restart.

- i-Vu® Standard or Plus v5.1 addressing

Addressing

Name:

Obtain an IP address automatically

i-Vu Address: . . .

Subnet Mask: . . .

IP Gateway Address: . . .

DNS Address: . . .

Domain:

USB Network Address: . . .

i-Vu Port Configuration

HTTP : HTTPS :

Note: Changing these values forces a webserver restart.

Backup data from i-Vu® Standard or Plus Management Tool

Access the **Management Tool** using one of the following methods:

- Click , then select **System Options > General tab > Management Tool**.
- Launch your browser and type your system name followed by :8080. For ex.: <http://ivu:8080/>.

NOTE You need the Installer privilege to access the Management Tool.

Use either of the following methods to backup your data from both databases.

Backup data to your PC

- 1 Click **PC Backup** under **Manage Server Data** to save the entire i-Vu® database zipped into one file to your PC.
- 2 Click **OK** when you see the message **The system will be stopped and restarted. Do you wish to proceed?** Watch **Operation Status** to see the progress.
- 3 Click the message **Save/Download Backup File to Your Local Hard drive** when it appears.
- 4 Click **Save** when asked **Do you want to open or save this file?**
- 5 Save the file (system.backup.tgz) to a convenient location on your computer.
CAUTION! Do not alter the name of this file!
- 6 Exit from **Management Tool**.
- 7 You must reboot the web server before proceeding.

Backup data to a USB drive

- 1 Plug your USB drive into any available USB port on your i-Vu® web server.
- 2 Click **USB Backup** under **Manage Server Data** to save the entire i-Vu® database zipped into one file to your USB drive.
- 3 Click **OK** when you see the message **The system will be stopped and restarted. Do you wish to proceed?** The **Operation Status** message updates as the i-Vu® application prepares and creates the backup. Wait for **Operation Status** to state **No Background Operations Currently Active.**,
- 4 Remove USB drive from the web server.

NOTES

- A check of the USB drive will show a backup file named **system.backup**
 - An error may be displayed under the **Management Tool** title stating **The USB device failed to mount and initialize. Connect the USB drive to the first USB port.** In this case, try a different USB drive or try rebooting the i-Vu® web server, as there was an issue accessing the USB drive.
- 5 Exit from **Management Tool**.
 - 6 You must reboot the web server before proceeding.

Install i-Vu® software

Use the following steps to install the i-Vu® v7.0 application on **both** of your web servers.

- 1 Remove the i-Vu® Standard or Plus web server from the network by disconnecting the LAN cable.
- 2 Insert the appropriate i-Vu® Standard or Plus USB Installation drive into the USB port or CD drive on the web server.
- 3 Shut down the web server by pushing the On/Off button **once**.
NOTE For MP model number i-Vu web servers, wait for the blue light to turn off (could take as long as 2 minutes).
- 4 Press the On/Off button again to restart the web server. The installation begins automatically.
- 5 The server will shut down when the installation is complete. This process takes several minutes.
NOTE Do not power off during the installation.
- 6 Remove the USB drive or CD.
- 7 Repeat these steps for the second server.

Restore data from backups

When merging an existing CCN and Open system, the database that you restore on the target web server becomes the primary database. Restoring includes all settings, including database, operators, alarms, and trends. You merge the second database using a clipping, which does not include operators or trends.

On your target web server:

- 1 Click **PC Restore** or **USB Restore** under **Manage Server Data** in the **Management Tool**.
 - o **PC Restore** - Browse to your backup file and click **Perform Restore**.
 - o **USB Restore** - Place your backup USB drive in any port on the i-Vu® web server. Select the backup file and click **Perform Restore**.
- 2 Restore is complete when **Operation Status** displays **No Background Operations Currently Active**.

Troubleshoot, import secondary database, and resolve conflicts

Export source files (drivers, .equipment, .view, and .bacview files) from the secondary database and import them into the primary database to identify and fix any equipment file names that may be duplicated in both databases. After you fix the conflicts, you export a clipping file (Source Files, database, and trends) from the secondary database and import it into the primary database on the new web server.

If you skip using source files for removing conflicts and proceed directly to exporting and importing the clipping file, when duplicate file names are encountered during the clipping process, you must delete one of the files completely or stop the entire import process, fix the conflict, and start importing all over again.

NOTE A system clipping file takes time to import. You can see the estimated time for each database in **System Options > General tab > System Statistics**.

Fixing potential conflicts

- 1 Export source files from your secondary database. Select **System Options > General tab > Source Files > Export** button.
- 2 Close **System Options**.
- 3 Access the new web server.
- 4 Import the source files into the primary database. Select **System Options > General tab > Source Files > Import** button.
- 5 Browse to the source files you just exported and click **Open**.
- 6 Click **Continue**. You can copy the list of conflicts to use for a troubleshooting reference.
- 7 Resolve conflicts before proceeding. To change the name of a custom equipment file:
 - o If the control program was made in Snap, open it in Snap and save with a different name.
 - o If the control program was produced in ApplicationBuilder, open the equipment file in EquipmentBuilder and save the file with another name.

Import the secondary database into the web server

Clippings include source files, database, and trends. They do not include operators or alarms.

- 1 Export a clipping file from the secondary database, which resides in the original web server. Select **System Options > General tab > Clippings > Export** button.
- 2 Click **Save**.
- 3 Import the clipping file into the primary database on the primary web server. Select **System Options > General tab > Clippings > Import** button.
- 4 Browse to the exported clipping.
- 5 Click **Next**.

NOTE You must resolve conflicts or problems that are displayed during the clipping import. In the case of duplicate file names, your only options are to delete one of the files completely or stop the entire import process, fix the conflict, and start the entire clipping import again.

- 6 Verify that the imported devices are communicating. In the i-Vu® Express interface, select one router at a time in the navigation tree and click the **Devices** tab.
- 7 *Back up the merged system to your PC from the Management Tool (page 37).*

Update your routers and controllers



CAUTION Update your routers and controllers only **once**. Use either the i-Vu® application **or** Field Assistant.

Router and controller configurations are maintained when you update them using the procedure below.

Step 1: Update the files for routers

- 1 Select the router that you wish to update in the navigation tree.
- 2 Right-click and select **Driver Properties**.
- 3 Select **Properties** page > **Update** tab.
- 4 If the database contains two or more routers, you must check **Change for all controllers of this type?** in the **Controller** section.
- 5 Click **Update**. A message appears **Changes the driver and screen file to use the current library version. Continue?**

NOTE If more than one router exists, the additional routers are listed below the **Update** button.

- 6 Click **OK**.
- 7 Click **Accept**.

Step 2: Update the files for controllers

- 1 Double-click the controller in the navigation tree or right-click and select **Configure**.
- 2 If you have multiple controllers of the same type, enable **Change for all control programs of this type?**
- 3 Click **Update** under **Control Program**. A message appears **Changes the control program, view, driver, and screen file to use the current library version. Continue?**
- 4 Click **OK**. When the message **Updated to the library version xx.** appears, click **Close**.
- 5 Repeat steps 1 - 4 for any additional types of controllers.
- 6 Click **Close** again.

Step 3: Update the files for CCN controllers

- 1 In the navigation tree, select the CCN device manager associated with the controllers that are to be updated.
- 2 Select **Devices > CCN Discovery** and re-scan any controllers that need to be updated by checking **Rescan Controllers Selected Below for Configuration Changes** and clicking **Start Scan**.

Step 4: Apply the update to routers and controllers

- 1 Select the **System**  in the navigation tree and then select the **Downloads** page.
- 2 If you wish to apply the new SAL file to your entire system, you can use this page to compare to your navigation tree and verify that you have selected all of your routers and controllers for download.

NOTE Only the CCN Gateway and device managers require download, so the CCN controllers/equipment are not listed.
- 3 A network's controllers download in the order shown. To change the order, select a controller(s), then drag and drop or click **Move to Top** or **Move to Bottom**.

EXCEPTION If a controller's router requires a download, it will download first regardless of its position on the Downloads page. Click the **Start** button.

NOTES

- Use **Ctrl+click**, **Shift+click**, or the **Select All** checkbox to select multiple controllers.
- See To download from the Downloads page in Help for more details.

After the upgrade

- **Add-ons**
 - Some add-ons have been updated for compatibility with the i-Vu® Express application . Be sure that you have the latest version of the add-ons that were used in the previous version.
 - Click **System Menu**  > **System Options > System Settings > Add-ons** tab, select the add-on, then click **Remove Add-on and Keep Data**. Install the latest version of the add-on.
 - To increase security of a i-Vu® Express system, by default, the i-Vu® Express application allows only add-ons that are supported and signed by Carrier®. However, you can run an unsigned add-on. You must open SiteBuilder and go to **Configure > Preferences > Web Server**, and check **Allow unsigned add-ons**.
- **Schedules**—Descriptions are limited to 50 characters. You must shorten any schedule descriptions over 50 characters or the schedules will not download.
- **Alarm sounds**—If an operator's **My Settings** page had an alarm sound file defined, copy the file from the old system to the new system.
- **Interface images and Graphics pages**—On each client computer, clear the web browser's cache to avoid error messages, strange graphics, or images.
 - In Edge®, search "Clear browsing data".
 - In Safari®, search "empty cache".
 - In Mozilla® Firefox®, search "clear cache".
 - In Google™ Chrome™, search "delete cache".

Troubleshooting

WARNINGS!

- Do NOT change the BIOS settings in any way or the software will fail.
- Mount your i-Vu® Express web server in an air conditioned space to avoid damage.
- Do NOT open the i-Vu® Express web server! Opening the web server voids your warranty.

If unable to access the i-Vu® Express web server in web browser

- 1 Verify that the i-Vu® Express web server is on.
- 2 Verify that the web server has a valid IP address by connecting a monitor and keyboard to the server. See *Connect a monitor directly to the i-Vu® Express web server* (page 44).
- 3 Check that a valid Ethernet connection exists on the computer. (See Example 1.)
- 4 Open a Command window (See *Example 2* (page 44).) and ping the i-Vu® Express web server by its default name (ivu).
 - If pinging is successful, then the problem is most likely in the computer’s browser settings. Check your web browser to determine if a proxy server or automatic configuration script is being used.
 - If you are using a proxy server, you must add the name of the i-Vu® Express web server to the exceptions list of the proxy server.
 - If an auto-configuration script is being used, adding the i-Vu® Express web server to the exceptions list is not possible. Contact your local Information Technology (IT) group for assistance.
 - If pinging fails, but the i-Vu® Express name is resolved to an IP address, as shown below, the problem could be that pinging is disabled on the LAN.

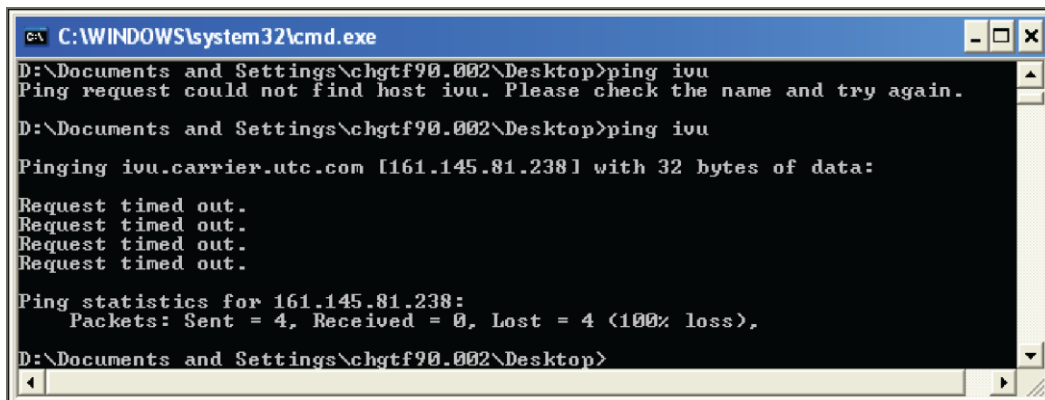

- If this is the case, check the proxy server settings in your web browser.
- If the problem isn’t with the proxy server settings and pinging is enabled on the LAN, failing to ping successfully could mean that the i-Vu® Express name is resolving to an incorrect IP address.

Try the following:

- 1 Open a Command window (See *Example 2* (page 44)) and type in the following commands: “nbtstat -R” <enter>.
- 2 Type in “ipconfig /flushdns” <enter>.
- 3 Try pinging the i-Vu® Express web server again by name.
 - If successful, try accessing the i-Vu® Express application with your web browser. If not successful try accessing it in your web browser by IP address, i.e. https://161.145.81.238. If this is not successful, contact your local IT group to resolve this issue.
 - If pinging fails with any other error than what is shown in the graphic above, contact your local IT group to assist you. The IT group may want to know what IP address the i-Vu® Express web server is actually using. To determine this, connect a monitor to the HDMI port in the back of the i-Vu® Express web server and power down. Now power up the i-Vu® Express web server and the IP configuration information displays at the end of the boot process.

Example 1: Determining if a valid Ethernet connection exists

Ensure there is a proper Ethernet connection, using one of the following methods:

- Click **Start** and type **nca.cpl** in the Search  box.
- Click **Start > Control Panel > Network and Internet > Network and Sharing Center > Change Adapter Settings**.

NOTE On the Control Panel screen, verify that **Adjust your computer's settings** is set to **View by: Small (or Large) icons**.

Under LAN or high speed Internet, find your Network Interface Card icon and ensure that a red **X** is not displayed over the icon.

If the connection that is used for the i-Vu® Express web server shows a red **X**, then check that the Ethernet cable is fully plugged in and that the correct type of Ethernet cable is being used, i.e. crossover or patch cable.

You must have a live Ethernet connection to successfully connect to the i-Vu® Express web server.

Example 2: Pinging by computer name

- 1 Click **Start** and type “cmd” in the Search box and click **Enter**.
- 2 Type “ping ivu” to ping the default name of the i-Vu® Express web server. If you have a good connection, you should see 4 replies.

```

Administrator: C:\Windows\system32\cmd.exe
Microsoft Windows [Version 6.1.7601]
Copyright (c) 2009 Microsoft Corporation. All rights reserved.

C:\>ping ivu

Pinging ivu.carrier.utc.com [161.145.175.56] with 32 bytes of data:
Reply from 161.145.175.56: bytes=32 time=1ms TTL=64
Reply from 161.145.175.56: bytes=32 time<1ms TTL=64
Reply from 161.145.175.56: bytes=32 time<1ms TTL=64
Reply from 161.145.175.56: bytes=32 time<1ms TTL=64

Ping statistics for 161.145.175.56:
    Packets: Sent = 4, Received = 4, Lost = 0 (0% loss),
    Approximate round trip times in milli-seconds:
        Minimum = 0ms, Maximum = 1ms, Average = 0ms
    
```

- 3 Note name and IP address.

Connect a monitor directly to the i-Vu® Express web server

In the event that you lose your system name and system IP address, you must connect the i-Vu® Express web server directly to a monitor and keyboard. Purchase a VGA/DVI/HDMI adapter (VGA/DVI/HDMI - whichever fits your monitor) to connect to your monitor.

- 1 Turn on the monitor.
- 2 Turn off the i-Vu® Express web server.
- 3 Plug the HDMI adapter into the HDMI port on the i-Vu® Express web server.
- 4 Plug the adapter into the monitor.
- 5 Plug the keyboard into a USB port on the i-Vu® Express web server.
- 6 Turn on the i-Vu® Express web server.
- 7 Press **Esc** on your keyboard to clear the banner. Your monitor displays the i-Vu® Express web server's system information.

System Management

Although the i-Vu® Express application is a reliable front-end, you must perform periodic backups of the i-Vu® Express database to ensure a quick recovery in case of failure. To ensure that your controllers have the latest version of software, the i-Vu® Express web server must have internet access in order to download periodic updates. The sections below describe how to backup and restore the i-Vu® Express database.

Using the Management Tool

Access the Management Tool using one of the following methods:

- Click , then select **System Options > General tab > Management Tool**.
- Launch your browser and type the host name followed by `/mgtool/`. (Ex. `https://ivu/mgttool/`)

NOTES

- The Management Tool is password-protected and can only be accessed by a user with Installer role.
- After 5 invalid login attempts, you will be locked out for 30 minutes.
- If multiple users are in the Management Tool at the same time, only the first one to access it is able to make changes. Other users see it in View Only mode.
- If you are in the Management Tool and are inactive for 30 minutes, you will be logged out. You must refresh the browser and log back in.

To access the Management Tool for the first time or after resetting to factory defaults

Log in with the following factory default credentials:

Username—management

Password—First 8 digits of the Appliance ID followed by "@I" (uppercase letter I). (Ex. 12345678@I)

NOTE You can find the Appliance ID in several locations:

- on the back of the i-Vu® Express web server
- on the i-Vu® Express shipping box
- under **Device ID** if a monitor is connected to the i-Vu® Express web server

Once you have set up a system, the factory default credentials are no longer valid. Use your i-Vu® credentials with Installer privilege to access the Management Tool.

Each tab in the Management Tool is outlined below.

| System Status | |
|---|--|
| System Status | <p>Use to troubleshoot server or LAN communications.</p> <p>Click Stop Server to stop the i-Vu® Express web server. When stopped, the button changes to Start Server. Do NOT close the Management Tool before restarting the server. Click to restart.</p> |
| System logs | <p>Use for troubleshooting (same as logs available from System Options > General tab). Logs are available for a maximum of 4 weeks.</p> |
| Manage System | |
| Backup | Save the entire database zipped into one file to your computer. |
| Restore | Replace the current server data with a backup from an i-Vu® Express system. |
| Legacy Restore | Replace the current server data with a backup from a v7.0 or earlier i-Vu® system. |
| Reset Defaults | <p>Delete all server data and reset the device to the original factory default values.</p> <p>NOTE Executing this option does not delete configuration data under the Addressing section of the Management Tool.</p> |
| Reboot host OS | Restart the host operating system running on appliance and all application services. |
| Addressing | |
| Name | <p>The name used to access your system from the Internet. Do not use special characters or spaces.</p> <p> CAUTION If you change the name or the IP address of your system, record the numbers in a secure place.</p> |
| Obtain an IP address automatically | <p>Uncheck this field to manually assign addresses for the following:</p> <ul style="list-style-type: none"> ○ i-Vu Address ○ Subnet Mask ○ Default Gateway ○ DNS Address – IP address of the Domain Name Server ○ Domain – Host name of the domain ○ USB Network Type – Read-only field shows either CCN or BACnet types. ○ USB Network Address – IP address of the internal BACnet router or the internal CCN Gateway |
| Redirect HTTP requests to HTTPS | Check this field to have all HTTP requests automatically redirected to the more secure HTTPS. |

NTP

Enable time synchronization from an NTP server

Network Time Protocol (NTP) is a networking protocol for clock synchronization. You can designate an NTP source that sends the correct time to the i-Vu® Express web server, ensuring constant accurate time. You can enter 2 static addresses (DNS name or IP) of NTP servers or use the default addresses provided by the i-Vu® Express application. If you do not enable NTP, the i-Vu® Express system clock must be monitored and updated regularly in **System Options > General** tab.

You can configure DHCP servers to supply IP addresses of NTP servers to the i-Vu® Express web server. If you have checked **Obtain an IP address automatically** on the **Addressing** tab and **Enable Time Synchronization** on the **NTP** tab, the i-Vu® Express web server tries to obtain an NTP server address from the DHCP server on site. If it cannot find one, the i-Vu® Express web server uses the User Assigned NTP addresses, if any, in the User Assigned fields.



CAUTION Contact your Network Administrator for guidance in entering these settings.

User Assigned NTP Server Address

You can use the default website addresses if your system allows it. Firewalls may prevent successful access to the default websites. Your Network Administrator can provide alternate addresses for a local server, a remote server, or a website.

Update Management

Current version

Displays your i-Vu® Express system's version information. Click on the current version for more details.

NOTE If the **Current version** field is blank, as shown below, the web server is not connected to the Balena Cloud and cannot receive updates. Check whether the web server can access api.balena-cloud.com by pinging the URL using a computer on the same subnet as the web server. If pinging is unsuccessful, contact the customer IT or ISP.

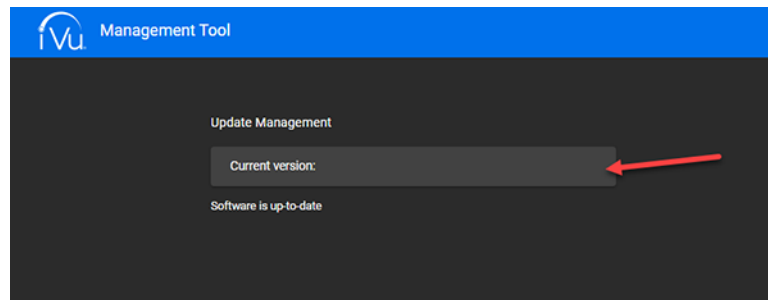

There is a software update available

Appears if a software update is available. Click **Apply** to download the update.

Backup data from i-Vu® Express Management Tool

Access the Management Tool using one of the following methods:

- Click , then select **System Options > General tab > Management Tool**.
- Launch your browser and type the host name followed by /mgttool/. (Ex. https://ivu/mgttool/)

Backup data to your computer

- 1 In the **Manage System** tab, click **Backup** to save the entire database zipped into one file to your computer.
- 2 Click **OK** when you see the message **The system will be stopped and restarted. Do you wish to proceed?** Watch **Operation Status** to see the progress.
- 3 Click the message **Save/Download Backup File to Your Local Hard drive** when it appears.
- 4 Click **Save** when asked **Do you want to open or save this file?**
- 5 Save this system.backup.zip file to a convenient location on your computer.
CAUTION! Do not alter the name of this file!
- 6 Exit from **Management Tool**.

Restore data from backup

- 1 Access the **Management Tool** using one of the following methods:
 - Click , then select **System Options > General tab > Management Tool**.
 - Launch your browser and type the host name followed by /mgttool/. (Ex. https://ivu/mgttool/)**NOTE** You need the Installer privilege to access the Management Tool.
- 2 Go to the **Manage System** tab.
 - If restoring a backup from an i-Vu® Standard or Plus system, click **Legacy Restore**.
 - If restoring a backup from an i-Vu® Express system, click **Restore**.
- 3 Browse to your backup file and click **Perform Restore**.
- 4 Restore is complete when **Operation Status** displays **No Background Operations Currently Active**.
- 5 If you wish to change the name of your i-Vu® Express system from the default **ivu**, enter the new name in the **Name** field under **Addressing**.

Restore factory defaults

Restoring factory defaults deletes your existing data and restores your system to factory defaults.

- 1 Access the **Management Tool** using one of the following methods:
 - Click , then select **System Options > General tab > Management Tool**.
 - Launch your browser and type the host name followed by /mgttool/. (Ex. https://ivu/mgttool/)
- 2 In the **Manage System** tab, click **Reset Defaults**. This deletes all server data and resets the device to the original factory default values.

NOTE Executing this option will not delete configuration data under the **Addressing** tab.

- 3 Begin setting up your system.

NOTE To access the Management Tool after restoring factory defaults, you must use the factory default login credentials until you set up your system. See *Using the Management Tool* (page 45).

Synchronize to system time

To update all routers and controllers to the system time:

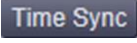
- 1 Click , then select **System Options > General** tab.
- 2 Click  to immediately synchronize all controllers.
- 3 To adjust the time when controllers are automatically synchronized each day, click **Enable time synchronization of controllers daily at** and fill in time.

Advanced topics

i-Vu® Express network connection options and requirements

You can use any of the following common network configurations (see below for details):

- **Option 1** - Connect to the Internet through the Intranet for both internal and external access
- **Option 2** - Connect to the Internet through a dedicated broadband account

Option 1 - Connect to the Internet through an Intranet for both internal and external access

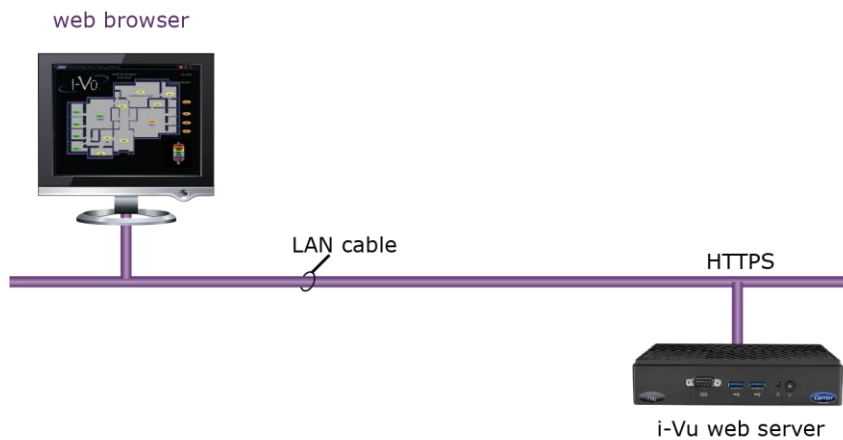

Requirements:

- Windows-based computer with supported web browser and Ethernet port
- Access to Ethernet LAN

A (DHCP or static) IP address for each of the following:

- One IP address for the i-Vu® Express web server (required)
- One IP address for the i-Vu® Express web server's internal router (optional)
- One IP address for each external i-Vu® router (if applicable)
- Internet IP address provided by the site's IT personnel
- Open firewall port for HTTP/HTTPS traffic to the i-Vu® Express web server's IP address (default is port 80/443 respectively)

Email Options - Email can be sent from both Internet and Intranet mail servers. To send email off of the LAN, the DNS and domain field must be properly configured in the i-Vu® Express web server.

Option 2 - Connect to the Internet through a dedicated broadband account



Requirements:

- Window-based computer with supported web browser and Ethernet port
- Broadband Internet connection (internet IP address provided by the Internet Service Provider)
- IP router (w/Integrated Switch if computer or external i-Vu® Express routers will be used)
- A (DHCP or static) IP address for each of the following:
 - One IP address for the i-Vu® Express web server (required)
 - One IP address for the i-Vu® Express web server's internal router (optional)
 - One IP address for each external i-Vu® router (if applicable)
- Open firewall port for HTTP/HTTPS traffic to the i-Vu® Express web server's IP address (default is port 80/443 respectively)

Email Options - Email can be sent from a local or an Internet mail server if network policies allow this.

If DHCP will not assign two IP addresses

The default IP configuration uses DHCP. The i-Vu® Express web server attempts to obtain its IP configuration information from a DHCP Server located on the same subnet. Most DHCP Servers will provide all of the information contained in the **Addressing** section of the **Management Tool**.

DHCP will not work in cases where the DHCP Server will not assign 2 unique IP addresses. You must configure the i-Vu® Express system with static IP addresses. See *Optional: Configure the i-Vu® Express system using a static IP address* (page 19).

Finding the MAC address of the i-Vu® Express web server

In some cases, the IT personnel may ask for the Ethernet MAC address of the i-Vu® Express web server. There are two ways you can obtain this information.

Option 1

- 1 Login to the i-Vu® Express application using the Administrator or Installer role.
- 2 Click **System Menu**  and select **Manual Command**.
- 3 Type **commstat** and click **OK**.
- 4 The Ethernet MAC address of the web server is listed as shown below.

```
Connection Type          Status      User Count  Lock Cnt/Time
-----
BACnet/IP Connection    Connected  1          0/ 0

User Name                Activity Time
-----
System                  1188

***** BACnet Settings *****
client service: local:172.16.1.37 subnet=172.16.255.255 port=47808 objid=8:169999 network=1600
Event Recipient: 169999
local:172.16.1.37 subnet=172.16.255.255 port=47808 objid=8:169999 network=1600 MAC Address=00-01-80-66-2d-65 DisableFieldEvents=false
Tuning parameters:
BACnet/IP Connection Comm Retries=3
BACnet/IP Connection Comm Timeout (in millis)=4000
BACnet/IP Connection Do Sync (in millis)=3600000
BACnet/IP Connection Register FD Interval (in sec)=600
```

Option 2

- 1 Carefully follow the instructions in *Connect a monitor directly to the i-Vu® Express web server* (page 44).
- 2 Once the server has restarted, the monitor displays the system information and the Ethernet MAC address is on the fourth line.

Using TCP/UDP ports

| Server Ports | |
|--|--|
| Port | Protocol/User |
| tcp*:53 | DNS |
| tcp*:80 | http (Web Server and Management Tool) |
| tcp*:1234 | Chronyd |
| tcp*:47806 | Alarm Notification Client |
| tcp*:47808 | Diagnostic Telnet* |
| tcp*:443 | https (Web Server and Management Tool) |
| udp*:53 | DNS |
| udp*:5353 | Multicast DNS (Avahi) |
| udp*:1234 | Chronyd |
| udp*:47808 | Bacnet/IP |
| udp*:47812 | CCN/IP |
| udp*:50005 udp*:50007 udp*:50008 | Firmware CCN/IP |
| udp*:50005-50008 | Firmware CCN/IP |

* This functionality is off by default. You can start it using the `telnetd` console command.

NOTES

- The i-Vu® Express web server listens through the ports.
- SOAP uses the HTTP port.
- You enable the Alarm Notification Client on the **System Options > General** tab.
- The CCN/IP and BACnet/IP ports have to be exposed if the connection between the i-Vu® Express web server and the routers contain a firewall.
- Ports are not configurable, with the exception of Alarm Notification Client.

Document revision history

Important changes to this document are listed below. Minor changes such as typographical or formatting errors are not listed.

| Date | Topic | Change description | Code* |
|-------------|--|--------------------------------------|--------------|
| 4/14/25 | Update the i-Vu® Express server | Updated procedure for new interface | X-PM-RD-J-RD |
| | Update your routers and controllers | | |
| 2/4/25 | What is the i-Vu® Express application? | Added Weather add-on asterisk | C-PM-RD-E |
| | System Management | Removed reference to install updates | |
| | Connect and power up the web server | Added graphics for UBX-110 | C-PM-TC-J-RD |
| | Optional: Mount the web server to a flat panel | Added caution | |
| | i-Vu® Express web server specifications | Added specifications for UBX-110 | |

* For internal use only

