

Heat Recovery

Model name:

MMY-MAP_6FT6P-UL (460V, 60Hz, 3 phase)

MMY-MAP_6FT9P-UL (208/230V, 60Hz, 3 phase)

MMY-MAP_6FT2P-UL (208/230V, 60Hz, 1 phase)

SHRM
SUPER HEAT RECOVERY MULTI



**Engineering
Data Book**

Full Version



Notice: Toshiba is committed to continuously improving its products to ensure the highest quality and reliability standards, and to meet local regulations and market requirements. All features and specifications are subject to change without prior notice.









	Safety caution	2
1	System overview	5
	1-1. Allocation standard of model name	5
	1-2. Summary of system equipments	6
2	Equipment selection procedure	11
	2-1. Selection flow chart	11
	2-2. Combination conditions for indoor unit and outdoor unit	12
	2-3. Cooling/heating capacity characteristics	14
	2-4. Operational temperature range	27
3	Refrigerant piping design	28
	3-1. Free branching system	28
	3-2. Allowable length/height difference of refrigerant piping	29
	3-3. Selection of refrigerant piping	31
	3-4. Charging requirement with additional refrigerant	33
4	Wiring design	35
	4-1. General	35
	4-2. Outdoor unit power supply	35
	4-3. Indoor unit power supply	38
	4-4. Design of control wiring	40
5	Outdoor unit	42
	5-1. Specifications	42
	5-2. Dimensional drawing	74
	5-3. Center of gravity	86
	5-4. Branch header / Branch joint	87
	5-5. Refrigerant cycle diagram	91
	5-6. Wiring diagram	94
	5-7. Connecting diagram	101
	5-8. Applied control for Outdoor Unit	117
	5-9. Optional printed circuit board (PCB) of outdoor unit	119
	5-10. Sound pressure level data	127
	5-11. FS unit (Flow Selector unit)	134
	Appendix	142



- Before use, read carefully through the “Safety caution” section to ensure correct operation.
- The important contents concerned to the safety are described in the “Safety cautions”. Be sure to keep them. For Indications and their meanings, see the following description.

■ Warning Indications on the Air Conditioner Unit

Warning indication		Description					
 <table border="1"> <tr> <td colspan="2">WARNING</td> </tr> <tr> <td colspan="2">ELECTRICAL SHOCK HAZARD</td> </tr> <tr> <td colspan="2">Disconnect all remote electric power supplies</td> </tr> </table>	WARNING		ELECTRICAL SHOCK HAZARD		Disconnect all remote electric power supplies		WARNING ELECTRICAL SHOCK HAZARD Disconnect all remote electric power supplies before servicing.
WARNING							
ELECTRICAL SHOCK HAZARD							
Disconnect all remote electric power supplies							
 <table border="1"> <tr> <td colspan="2">WARNING</td> </tr> <tr> <td colspan="2">Moving parts.</td> </tr> <tr> <td colspan="2">Do not operate unit with grille removed.</td> </tr> </table>	WARNING		Moving parts.		Do not operate unit with grille removed.		WARNING Moving parts. Do not operate unit with grille removed. Stop the unit before servicing.
WARNING							
Moving parts.							
Do not operate unit with grille removed.							
 <table border="1"> <tr> <td colspan="2">CAUTION</td> </tr> <tr> <td colspan="2">High temperature parts.</td> </tr> <tr> <td colspan="2">You might get burned when removing this panel.</td> </tr> </table>	CAUTION		High temperature parts.		You might get burned when removing this panel.		CAUTION High temperature parts. You might get burned when removing this panel.
CAUTION							
High temperature parts.							
You might get burned when removing this panel.							
 <table border="1"> <tr> <td colspan="2">CAUTION</td> </tr> <tr> <td colspan="2">Do not touch the aluminum fins of the unit.</td> </tr> <tr> <td colspan="2">Doing so may result in injury.</td> </tr> </table>	CAUTION		Do not touch the aluminum fins of the unit.		Doing so may result in injury.		CAUTION Do not touch the aluminium fins of the unit. Doing so may result in injury.
CAUTION							
Do not touch the aluminum fins of the unit.							
Doing so may result in injury.							
 <table border="1"> <tr> <td colspan="2">CAUTION</td> </tr> <tr> <td colspan="2">BURST HAZARD</td> </tr> <tr> <td colspan="2">Open the service valves before the operation,</td> </tr> </table>	CAUTION		BURST HAZARD		Open the service valves before the operation,		CAUTION BURST HAZARD Open the service valves before the operation, otherwise there might be the burst.
CAUTION							
BURST HAZARD							
Open the service valves before the operation,							
 <table border="1"> <tr> <td colspan="2">CAUTION</td> </tr> <tr> <td colspan="2">Do not climb onto the fan guard.</td> </tr> <tr> <td colspan="2">Doing so may result injury</td> </tr> </table>	CAUTION		Do not climb onto the fan guard.		Doing so may result injury		CAUTION Do not climb onto the fan guard. Doing so may result in injury.
CAUTION							
Do not climb onto the fan guard.							
Doing so may result injury							

■ **Explanation of indications**

 **WARNING**

Improper handling of equipment could lead to serious injury or death.

 **CAUTION**

Improper installation of the equipment could lead to minor injury or property damage.

- After installation work is completed, please run the system in test mode for proper operation and explain the maintenance schedules to the customer as outlined in owner's manual. Please ask the customer to retain the installation and owner's manual for future reference.

 **WARNING**

The system should be installed by trained professional contractor by the factory.

Take precaution so that the refrigerant does not exceed the limit concentration even if it leaks when installing the unit in a small room.

Installation site location should be able to support the weight on the unit.

Ensure the room is properly ventilated in case of refrigerant leak during installation.

Leakage test should be performed to ensure there are no refrigerant leaks after installation.

Empty refrigerant cylinder should be used to recover the refrigerant from the system during repair or re-installation work. Do not store system refrigerant at outdoor unit.

Certified electrician should perform all the electrical work in order to comply with national and local codes and regulations.

Use of proper size and type of wires is recommended for electrical and controls communication.

Ensure proper grounding of wire is carried out as needed through out the system.

 **CAUTION**

Avoid installation of the unit close to combustible gas or highly corrosion areas.

Be sure to attach an earth leakage breaker; otherwise an electric shock may be caused.

Using a torque wrench, tighten the flare nut in the specified method.

If the flare nut is exceedingly tightened, the flare nut is broken and a refrigerant leakage may be caused after a long time has passed.

WARNINGS ON REFRIGERANT LEAKAGE

Check of Concentration Limit

The room in which the air conditioner is to be installed requires a design that in the event of refrigerant gas leaking out, its concentration will not exceed a set limit.

The refrigerant R410A which is used in the air conditioner is safe, without the toxicity or combustibility of ammonia, and is not restricted by laws to be imposed which protect the ozone layer. However, since it contains more than air, it poses the risk of suffocation if its concentration should rise excessively.

Suffocation from leakage of R410A is almost nonexistent. With the recent increase in the number of high concentration buildings, however, the installation of multi air conditioner systems is on the increase because of the need for effective use of floor space, individual control, energy conservation by curtailing heat and carrying power etc.

Most importantly, the multi air conditioner system is able to replenish a large amount of refrigerant compared with conventional individual air conditioners. If a single unit of the multi conditioner system is to be installed in a small room, select a suitable model and installation procedure so that if the refrigerant accidentally leaks out, its concentration does not reach the limit (and in the event of an emergency, measures can be made before injury can occur).

In a room where the concentration may exceed the limit, create an opening with adjacent rooms, or install mechanical ventilation combined with a gas leak detection device.

The concentration is as given below.

$$\frac{\text{Total amount of refrigerant (lbs (kg))}}{\text{Min. volume of the indoor unit installed room ft}^3(\text{m}^3)} \leq \text{Concentration limit (lbs/ft}^3(\text{kg/m}^3))$$

Concentration limit

Compliance to the local applicable regulations and standards for the concentration limit is required.

NOTE 1:

If there are 2 or more refrigerating systems in a single refrigerating device, the amounts of refrigerant should be as charged in each independent device.

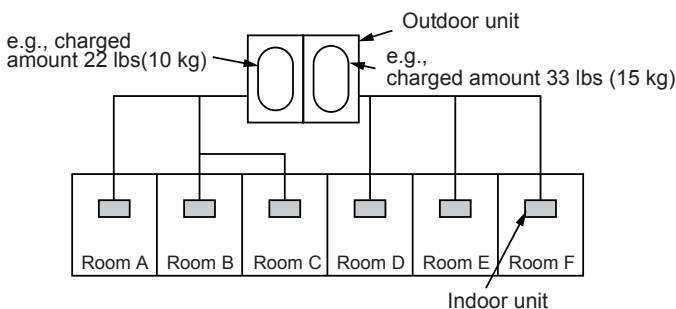

For the amount of charge in this example:

The possible amount of leaked refrigerant gas in rooms A, B and C is 22 lbs (10 kg).

The possible amount of leaked refrigerant gas in rooms D, E and F is 33 lbs (15 kg).

Important

NOTE 2:

The standards for minimum room volume are as follows.

- (1) No partition (shaded portion)

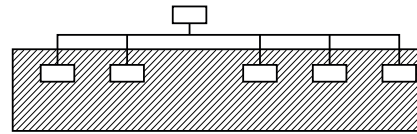

- (2) When there is an effective opening with the adjacent room for ventilation of leaking refrigerant gas (opening without a door, or an opening 0.15 % or larger than the respective floor spaces at the top or bottom of the door).

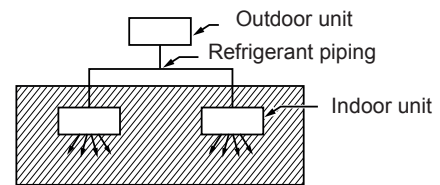

- (3) If an indoor unit is installed in each partitioned room and the refrigerant tubing is interconnected, the smallest room of course becomes the object. But when a mechanical ventilation is installed interlocked with a gas leakage detector in the smallest room where the density limit is exceeded, the volume of the next smallest room becomes the object.

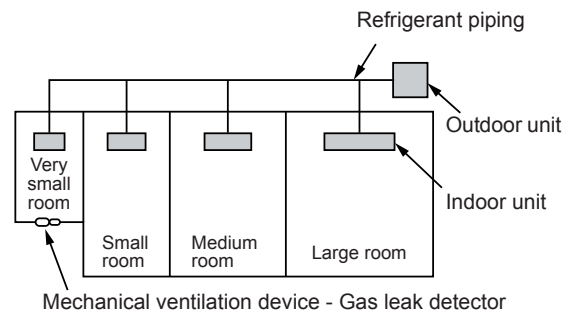



1-1. Allocation standard of model name

SHRM-e

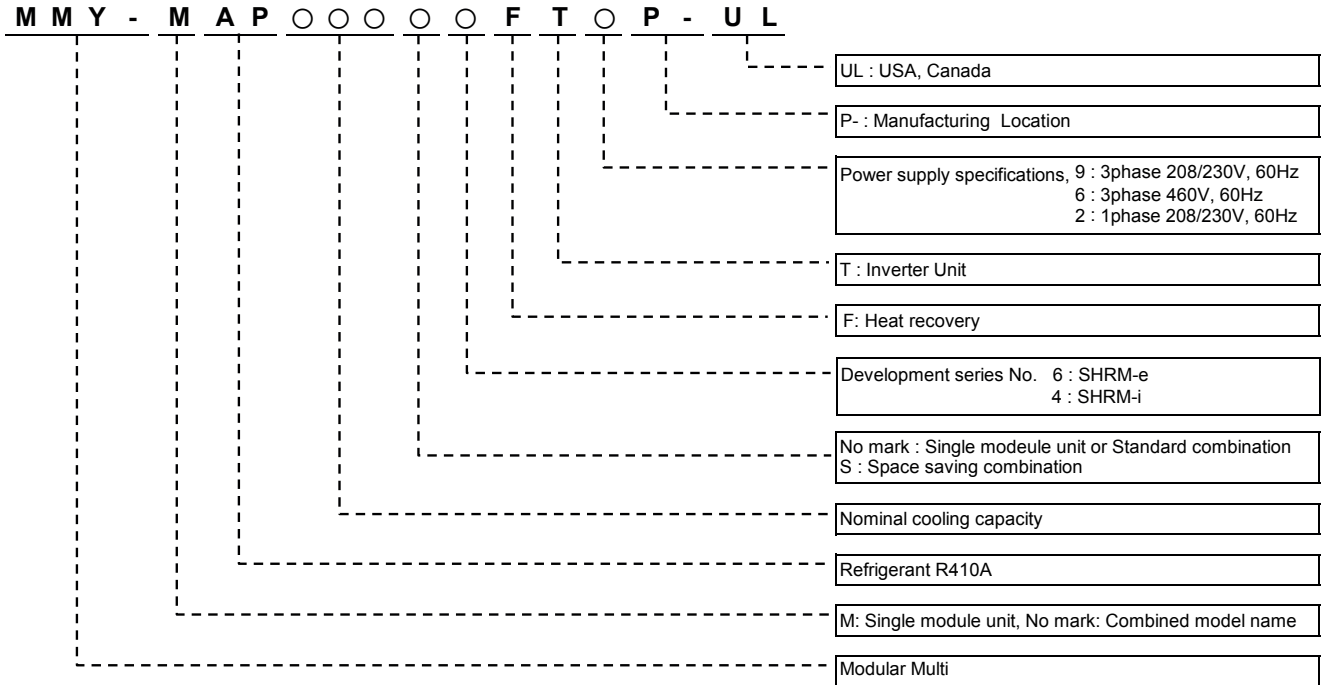

1-2. Summary of system equipments

1-2-1-1. Outdoor units, 3 phase

Unit type			Inverter unit					Appearance
Model name	208/230 V, 60 Hz	MMY-	MAP0726FT9P-UL	MAP0966FT9P-UL	MAP1206FT9P-UL	MAP1446FT9P-UL	MAP1686FT9P-UL	
	460 V, 60 Hz	MMY-	MAP0726FT6P-UL	MAP0966FT6P-UL	MAP1206FT6P-UL	MAP1446FT6P-UL	MAP1686FT6P-UL	
Capacity type			072 type	096 type	120 type	144 type	168 type	
Capacity code			072	096	120	144	168	

■ Combination of outdoor units

Unit type			Inverter unit					
Model name	208/230 V, 60 Hz	MMY-	AP1926FT9P-UL	AP2166FT9P-UL	AP2406FT9P-UL	AP2646FT9P-UL	AP2886FT9P-UL	AP3126FT9P-UL
	460 V, 60 Hz	MMY-	AP1926FT6P-UL	AP2166FT6P-UL	AP2406FT6P-UL	AP2646FT6P-UL	AP2886FT6P-UL	AP3126FT6P-UL
Capacity type			192 type	216 type	240 type	264 type	288 type	312 type
Capacity code			192	216	240	264	288	312
Combined outdoor units			096 type	120 type	144 type	144 type	144 type	168 type
			096 type	096 type	096 type	120 type	144 type	144 type

Unit type			Inverter unit					
Model name	208/230 V, 60 Hz	MMY-	AP3366FT9P-UL	AP3606FT9P-UL	AP3846FT9P-UL	AP4086FT9P-UL	AP4326FT9P-UL	AP4566FT9P-UL
	460 V, 60 Hz	MMY-	AP3366FT6P-UL	AP3606FT6P-UL	AP3846FT6P-UL	AP4086FT6P-UL	AP4326FT6P-UL	AP4566FT6P-UL
Capacity type			336 type	360 type	384 type	408 type	432 type	456 type
Capacity code			336	360	384	408	432	456
Combined outdoor units			120 type	120 type	144 type	144 type	144 type	168 type
			120 type	120 type	120 type	144 type	144 type	144 type
			096 type	120 type	120 type	120 type	144 type	144 type

Space saving model

Unit type			Inverter unit			
Model name	208/230 V, 60 Hz	MMY-	AP192S6FT9P-UL	AP240S6FT9P-UL	AP288S6FT9P-UL	AP336S6FT9P-UL
	460 V, 60 Hz	MMY-	AP192S6FT6P-UL	AP240S6FT6P-UL	AP288S6FT6P-UL	AP336S6FT6P-UL
Capacity type			192 type	240 type	288 type	336 type
Capacity code			192	240	288	336
Combined outdoor units			120 type	120 type	168 type	168 type
			072 type	120 type	120 type	168 type



1-2-1-2. Outdoor units, 1 phase

Unit type			Inverter unit	Appearance
Model name	208/230 V, 60 Hz, 1 Phase	MMY-	MAP0726FT2P-UL	
Capacity type			072 type	
Capacity code			072	

■ Combination of outdoor units

Unit type			Inverter unit
Model name	208/230 V, 60 Hz, 1 Phase	MMY-	AP1446FT2P-UL
Capacity type			144 type
Capacity code			144
Combined outdoor units			072 type
			072 type





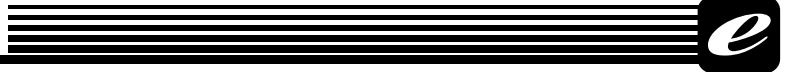

1-2-2 Indoor units



Type	Appearance	Model name	Capacity type	Capacity code	Cooling capacity	Heating capacity
					(kBTu/h)	(kBTu/h)
4-Way Cassette type		MMU-AP0074HPUL	007 type	7.5	7.5	8.5
		MMU-AP0094HPUL	009 type	9.5	9.5	10.5
		MMU-AP0124HPUL	012 type	12	12	13.5
		MMU-AP0154HPUL	015 type	15.4	15.4	17
		MMU-AP0184HPUL	018 type	18	18	20
		MMU-AP0244HPUL	024 type	24	24	27
		MMU-AP0304HPUL	030 type	30	30	34
		MMU-AP0364HPUL	036 type	36	36	40
		MMU-AP0424HPUL	042 type	42	42	47.5
		MMU-AP0484HPUL	048 type	48	48	54
MMU-AP0544HPUL	054 type	54	54	60		
Compact 4way Air Discharge Cassette type		MMU-AP0071MH2UL	007 type	7.5	7.5	8.5
		MMU-AP0091MH2UL	009 type	9.5	9.5	10.5
		MMU-AP0121MH2UL	012 type	12	12	13.5
		MMU-AP0151MH2UL	015 type	15.4	15.4	17
		MMU-AP0181MH2UL	018 type	18	18	20
Ceiling Type		MMC-AP0188HPUL	018 type	18	18	20
		MMC-AP0248HPUL	024 type	24	24	27
		MMC-AP0308HPUL	030 type	30	30	34
		MMC-AP0368HPUL	036 type	36	36	40
		MMC-AP0488HPUL	048 type	48	48	54
High wall type (With PMV)		MMK-AP0077HPUL	007 type	7.5	7.5	8.5
		MMK-AP0097HPUL	009 type	9.5	9.5	10.5
		MMC-AP0127HPUL	012 type	12	12	13.5
		MMC-AP0157HPUL	015 type	15.4	15.4	17
		MMC-AP0187HPUL	018 type	18	18	20
		MMC-AP0245HPUL	024 type	24	24	27
Slim Duct type		MMD-AP0074SPH2UL	007 type	7.5	7.5	8.5
		MMD-AP0094SPH2UL	009 type	9.5	9.5	10.5
		MMD-AP0124SPH2UL	012 type	12	12	13.5
		MMD-AP0154SPH2UL	015 type	15.4	15.4	17
		MMD-AP0184SPH2UL	018 type	18	18	20
Medium Static Concealed Duct type		MMD-AP0076BHPUL	007 type	7.5	7.5	8.5
		MMD-AP0096BHPUL	009 type	9.5	9.5	10.5
		MMD-AP0126BHPUL	012 type	12	12	13.5
		MMD-AP0156BHPUL	015 type	15.4	15.4	17
		MMD-AP0186BHPUL	018 type	18	18	20
		MMD-AP0216BHPUL	021 type	21	21	24
		MMD-AP0246BHPUL	024 type	24	24	27
		MMD-AP0306BHPUL	030 type	30	30	34
		MMD-AP0366BHPUL	036 type	36	36	40
		MMD-AP0426BHPUL	042 type	42	42	47.5
		MMD-AP0486BHPUL	048 type	48	48	54
MMD-AP0546BHPUL	054 type	54	54	60		
Concealed Duct High Static Pressure type		MMD-AP0246HPUL	024 type	24	24	27
		MMD-AP0306HPUL	030 type	30	30	34
		MMD-AP0366HPUL	036 type	36	36	40
		MMD-AP0486HPUL	048 type	48	48	54
		MMD-AP0546HPUL	054 type	54	54	60
Floor Standing Cabinet type		MML-AP0074H2UL	007 type	7.5	7.5	8.5
		MML-AP0094H2UL	009 type	9.5	9.5	10.5
		MML-AP0124H2UL	012 type	12	12	13.5
		MML-AP0154H2UL	015 type	15.4	15.4	17
		MML-AP0184H2UL	018 type	18	18	20
Floor Standing Concealed type		MML-AP0074BH2UL	007 type	7.5	7.5	8.5
		MML-AP0094BH2UL	009 type	9.5	9.5	10.5
		MML-AP0124BH2UL	012 type	12	12	13.5
		MML-AP0154BH2UL	015 type	15.4	15.4	17
		MML-AP0184BH2UL	018 type	18	18	20
MML-AP0244BH2UL	024 type	24	24	27		



1-2-3. Branching joints and headers

Name		Model name	Appearance
Y-shape branching joint	Heat recovery	RBM-BY55FUL	
		RBM-BY105FUL	
		RBM-BY205FUL	
		RBM-BY305FUL	
4-branching header	Heat recovery	RBM-HY1043FUL	
		RBM-HY2043FUL	
8-branching header	Heat recovery	RBM-HY1083FUL	
		RBM-HY2083FUL	
Branching joint for connection of outdoor units	Heat recovery	RBM-BT14FUL	
		RBM-BT24FUL	

1-2-4. FS units (Flow selector units)

Name	Model name	Appearance
FS unit	RBM-Y0383FUL	
	RBM-Y0613FUL	
	RBM-Y0963FUL	
	RBM-Y0384FUL	
	RBM-Y0614FUL	
	RBM-Y0964FUL	
	RBM-Y0611F4PUL	
	RBM-Y0611F6PUL	

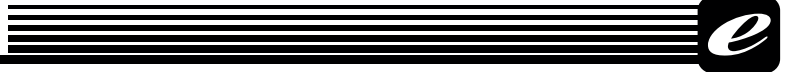

1-2-5. Remote control

Name	Model name	Remarks
Wired remote control	RBC-AMT32UL	
Wired remote control	RBC-AMS54E-UL	
Simple wired remote control	RBC-AS41UL	
Wireless remote control kit	RBC-AX32U(W)-UL	For 4-Way Cassette type
	RBC-AX33C-UL	For Ceiling type
	TCB-AX32UL	For Compact 4-Way Cassette type, Medium Static Ducted type, Slim Ducted type
Central remote control	BMS-CM1281TLUL	
Wired remote control with weekly timer	RBC-AMS41UL	

1-2-6. Optional PCB of outdoor unit

Name	Model name	Remarks
Power peak-cut control board	TCB-PCDM4UL	Power peak-cut control
External master ON/OFF control board	TCB-PCMO4UL	External master ON/OFF control, Night operation control, Operation mode selection control, Snowfall fan control
Output control board	TCB-PCIN4UL	Error / operation output control, Compressor operation output, Operating rate output

1-2-7. Controls

Name	Model name	Remarks
Remote location ON/OFF Control Box	TCB-IFCB-4UL	
"1:1 model" Connection Interface	TCB-PCNT31TLUL	UL Link adapter for "1:1 model" to enable connection to VRF system network.
LonWorks LN Interface	TCB-IFLN642TLUL	
Smart BMS manager	BMS-SM1280HTLUL	
Energy Monitoring Relay Interface	BMS-IFWH5UL	
Digital I/O Relay Interface	BMS-IFDD03UL	
BACnet Server	BMS-LSV6UL	
	BMS-STBN10UL	
TCS-NET Relay Interface	BMS-IFLSV4UL	
BN Interface	BMS-IFBN640TLUL	
Touch Screen Controller	BMS-CT5120UL	

"1:1 model" : RAV type indoor unit



2-1. Selection flow chart

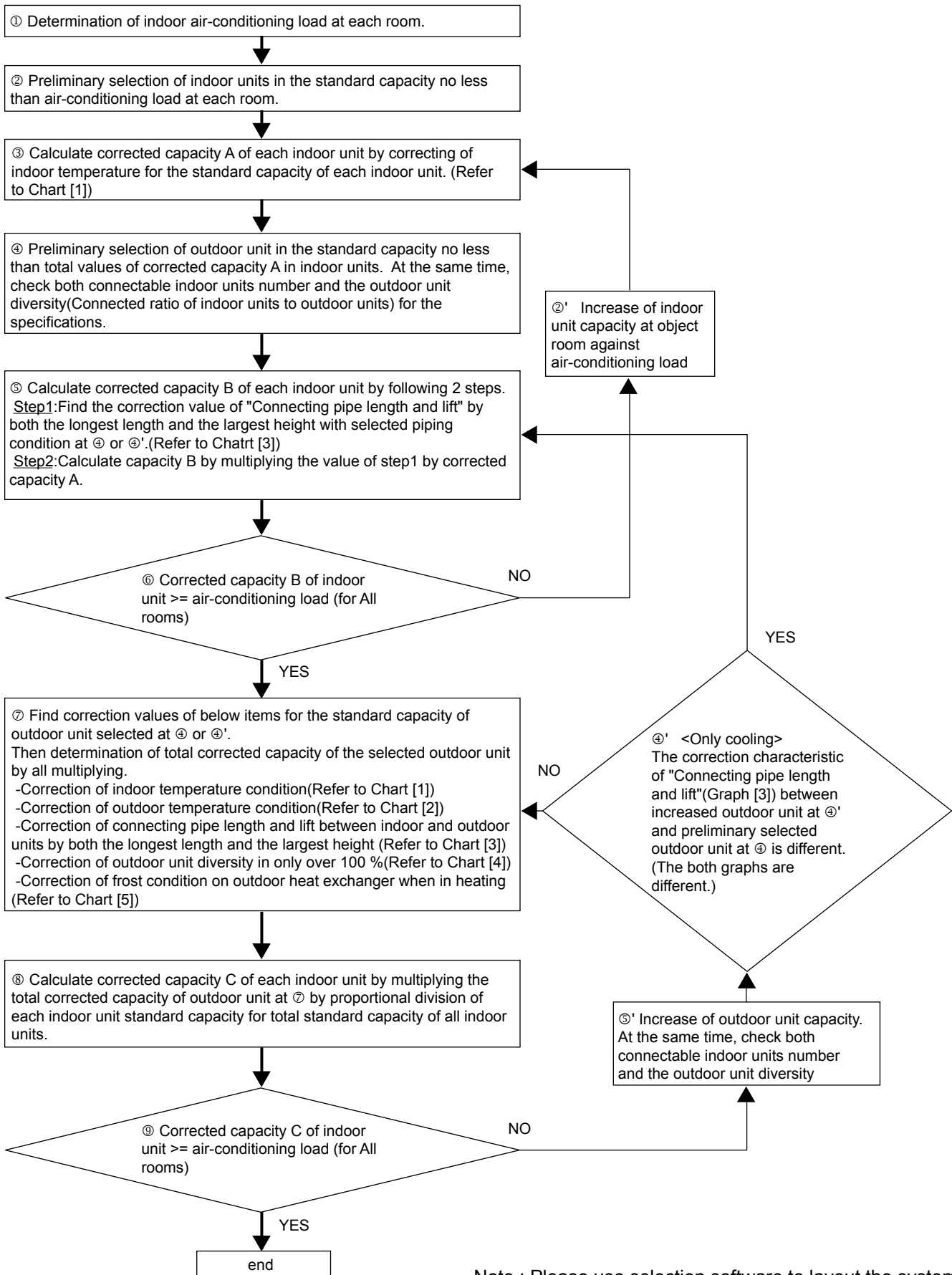

Note : Please use selection software to layout the system.



2-2. Combination conditions for indoor unit and outdoor unit

2-2-1. The capacity code of indoor unit is decided for each capacity type.

Indoor unit capacity type	007	009	012	015	018	021	024	027	030	036	042	048	054	072	096
Indoor unit capacity code	7.5	9.5	12	15.4	18	21	24	27	30	36	42	48	54	72	96

2-2-2. The capacity code of outdoor unit is decided for each capacity type.

Outdoor unit type	Outdoor unit capacity code	Maximum number of indoor units	
		Height difference between indoor units	
		49 ft (15 m) or less	Over 49 ft (15 m)
072type	72	12	10
096type	96	16	13
120type	120	21	16
144type	144	25	19
168type	168	30	23
192type	192	34	26
216type	216	38	29
240type	240	42	32
264type	264	46	36
288type	288	50	39
312type	312	*55	43
336type	336	*60	47
360type	360	*64	49
384type	384	*64	52
408type	408	*64	*55
443type	443	*64	*59
456type	456	*64	*63

* It is 54 units in case central control is in system.

NOTE

Compared with the capacity code of the outdoor unit, the total value of capacity codes of the connectable indoor units differs based on the height difference between the indoor units.

When the height difference between the indoor units is 49 ft (15 m) or less

Total indoor capacity code must be between 50% and 135% of the capacity of the outdoor unit.

When the height difference between the indoor units is over 49 ft (15m)

Total indoor capacity code must be between 50% and 105% of the capacity of the outdoor unit.

* If MMU-AP0122H2UL is included in the system, total indoor capacity code must be between 80% and 100% of outdoor unit capacity.

* Permanent operation below 80% is not recommended.



- If the system includes only the limited indoor unit type shown below, total indoor capacity code up to 150% of the outdoor capacity code is available when the height difference between the indoor units is 49ft(15m) or less.
- When total indoor capacity code exceeds 135% of outdoor unit capacity code, turn on SW09/Bit2 on I/F P.C. board of outdoor header unit.

- Limited indoor unit type for 150% connection

Type	Model name	Capacity type	Capacity code	Total Indoor Capacity code
4-Way Cassette type	MMU-AP0154HPUL	015 type	15.4	must be 80% - 150% of the capacity of the outdoor unit
	MMU-AP0184HPUL	018 type	18	
	MMU-AP0244HPUL	024 type	24	
	MMU-AP0304HPUL	030 type	30	
	MMU-AP0364HPUL	036 type	36	
	MMU-AP0424HPUL	042 type	42	
	MMU-AP0484HPUL	048 type	43	
Compact 4-Way Air Discharge Cassette type	MMU-AP0544HPUL	054 type	54	
	MMU-AP0071MH2UL	007 type	7.5	
	MMU-AP0091MH2UL	009 type	9.5	
	MMU-AP0121MH2UL	012 type	12	
	MMU-AP0151MH2UL	015 type	15.4	
Floor console recessed type	MMU-AP0181MH2UL	018 type	18	
	MML-AP0074BH2UL	007 type	7.5	
	MML-AP0094BH2UL	009 type	9.5	
	MML-AP0124BH2UL	012 type	12	
	MML-AP0154BH2UL	015 type	15.4	
	MML-AP0184BH2UL	018 type	18	
Concealed Duct High Static Pressure type	MML-AP0244BH2UL	024 type	24	
	MMD-AP0306HPUL	030 type	30	
	MMD-AP0366HPUL	036 type	36	
	MMD-AP0486HPUL	048 type	48	
Slim Duct type	MMD-AP0546HPUL	054 type	54	
	MMD-AP0074SPH2UL	007 type	7.5	
	MMD-AP0094SPH2UL	009 type	9.5	
	MMD-AP0124SPH2UL	012 type	12	
	MMD-AP0154SPH2UL	015 type	15.4	
	MMD-AP0184SPH2UL	018 type	18	

In case of up to 150% connection from 135% with limited indoor unit type, "Maximum number of indoor units" must be as follows.

Outdoor unit capacity type	Outdoor unit capacity code	Maximum number of indoor units	
		Height difference between indoor units	
		49 ft (15 m) or less	Over 49 ft (15 m)
072type	72	10	Not Available
096type	96	14	
120type	120	19	
144type	144	23	
168type	168	28	
192type	192	31	
216type	216	35	
240type	240	39	
264type	264	43	
288type	288	47	
312type	312	52	
336type	336	57	
360type	360	59	
384type	384	60	
408type	408	60	
432type	432	60	
456type	456	60	

2-3. Cooling/heating capacity characteristics

2-3-1. Correction charts for cooling capacity calculation

[Chart 1] Indoor air wet bulb temperature vs. capacity correction value

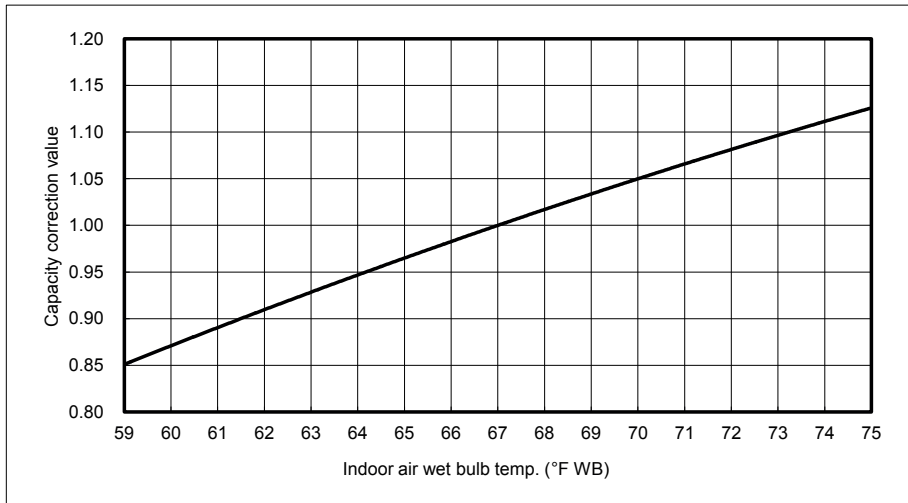

[Chart 2] Outdoor air dry bulb temperature vs. capacity correction value

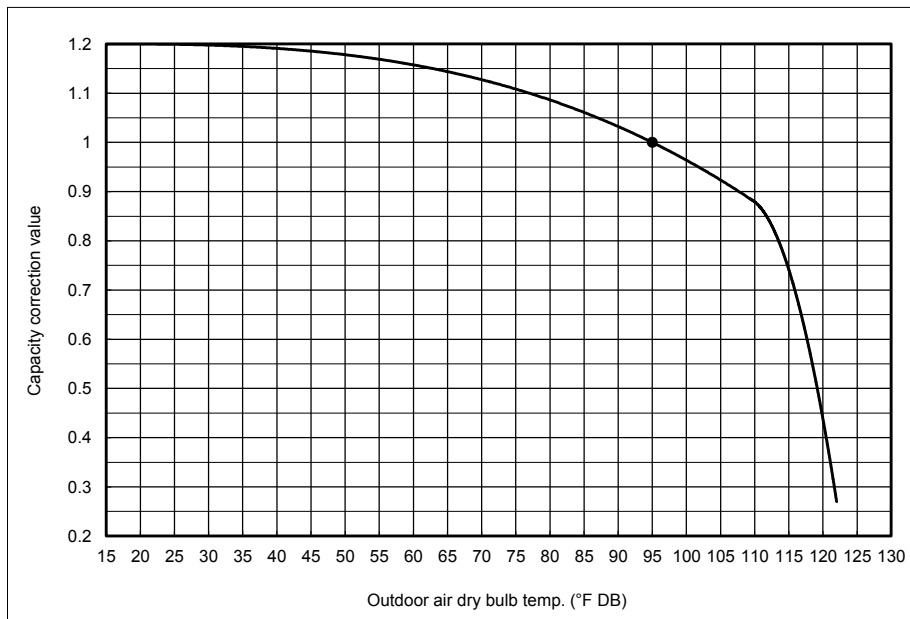

[Chart 3] Connecting pipe length and lift difference between indoor and outdoor units VS. capacity correction value

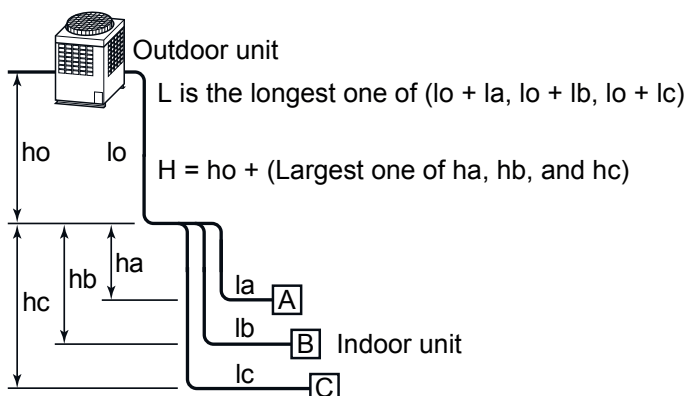

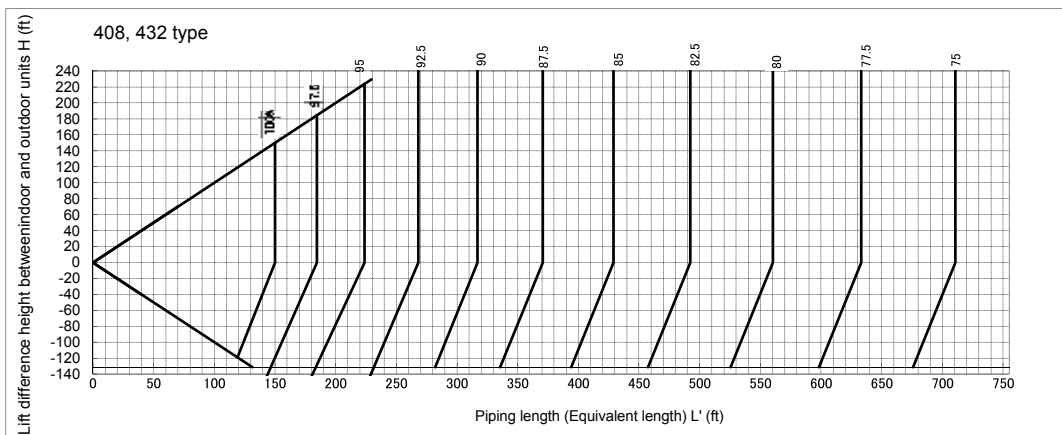
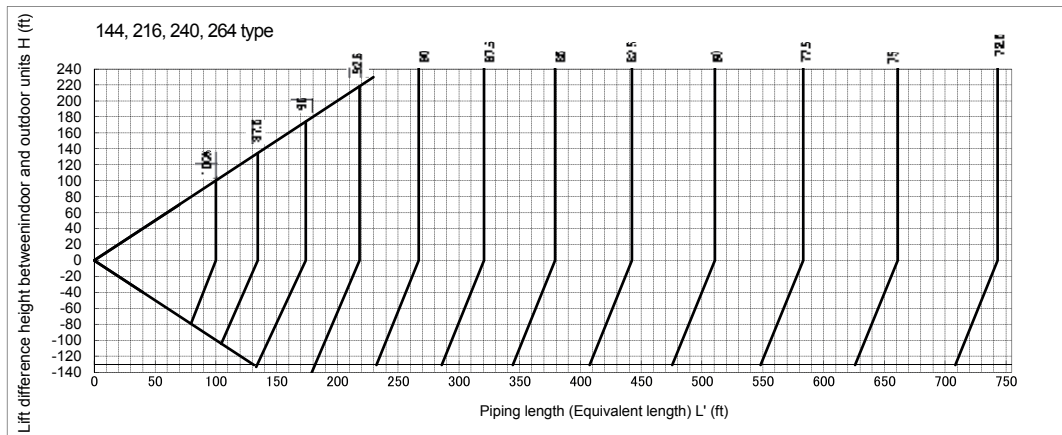
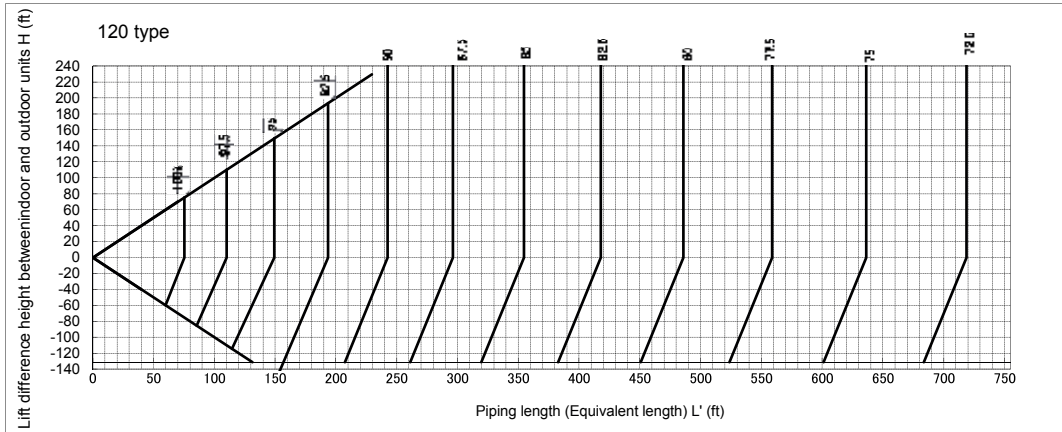

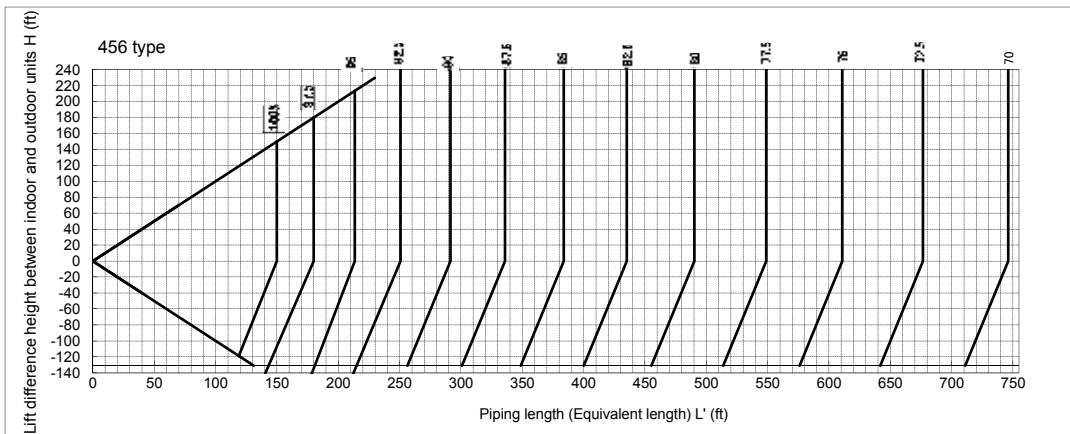
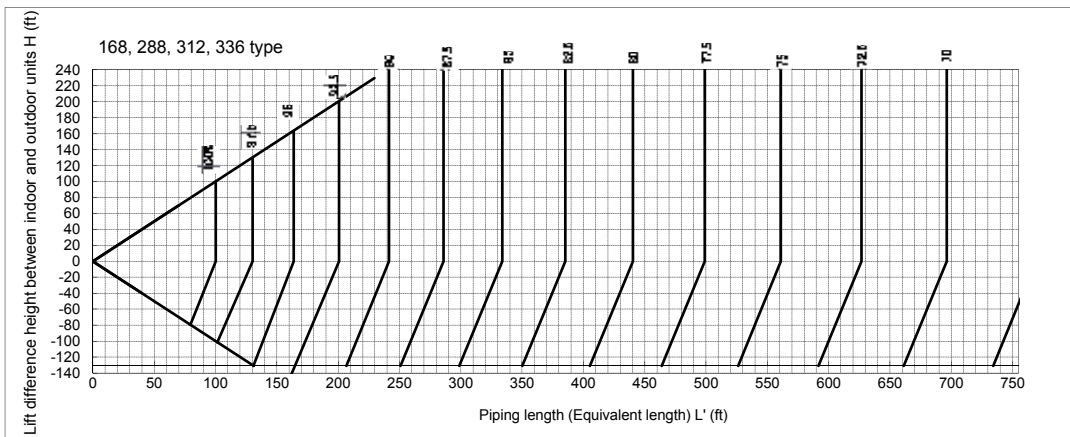
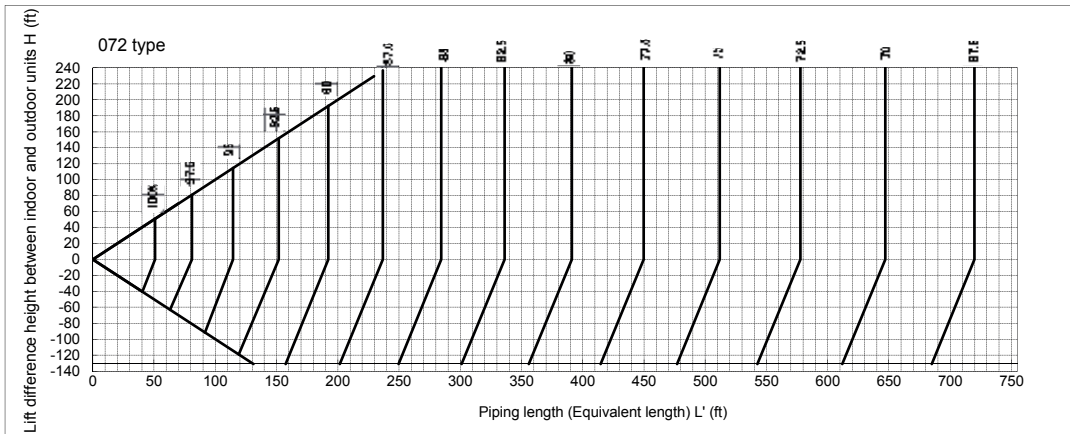

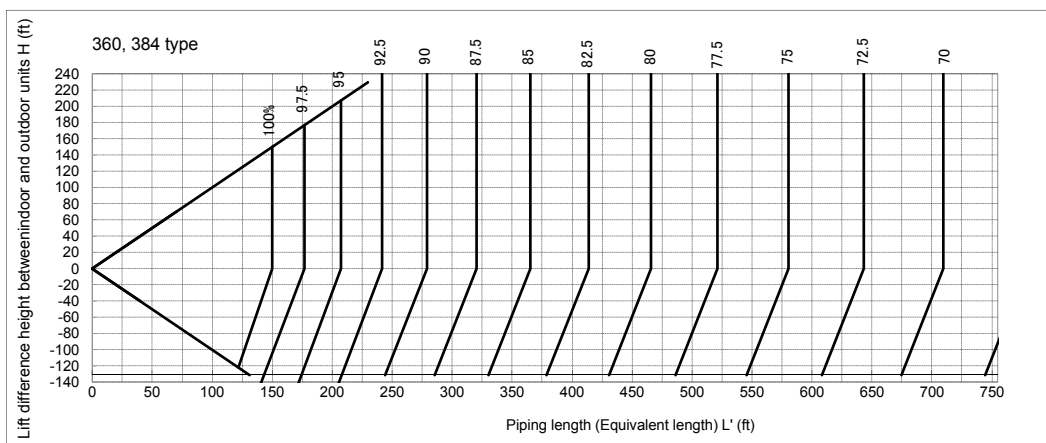
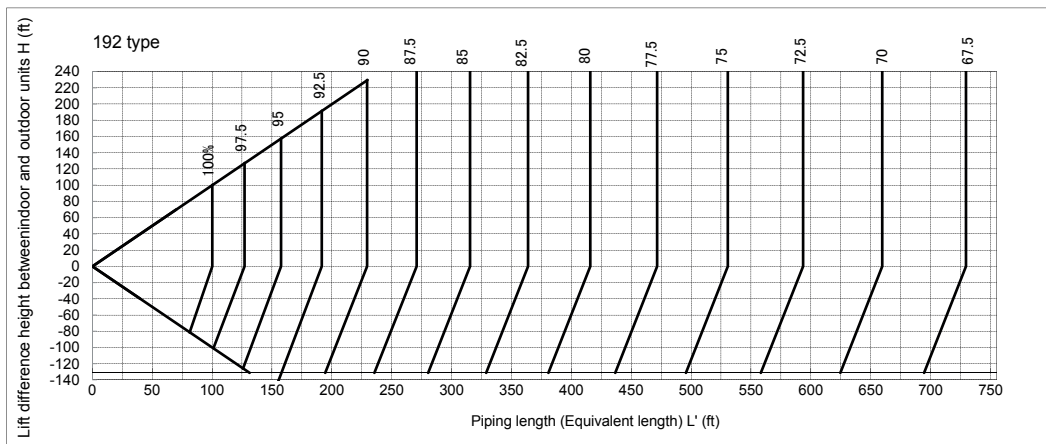
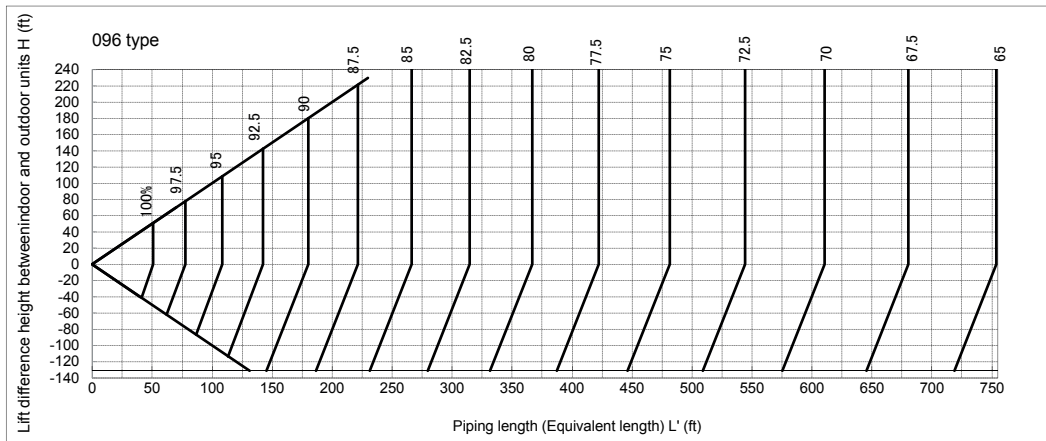



[4]* Correction of outdoor unit diversity

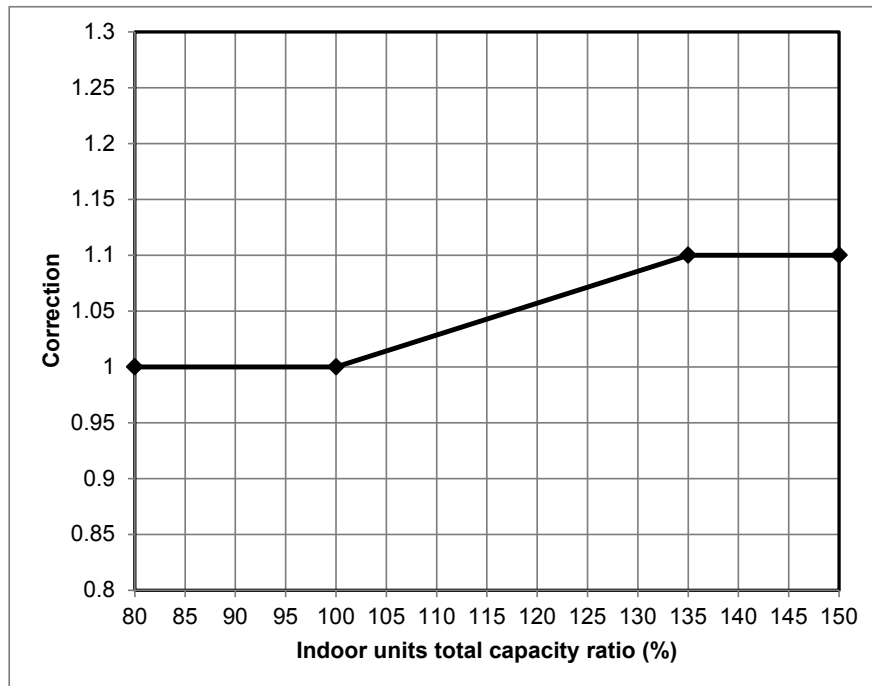

* Coefficient to use for the correction of the outdoor unit capacity when the total capacity of the indoor units are not equal to the outdoor unit capacity.



2-3-2. Correction charts for heating capacity calculation

[Chart 1] Indoor air dry bulb temperature vs. capacity correction value

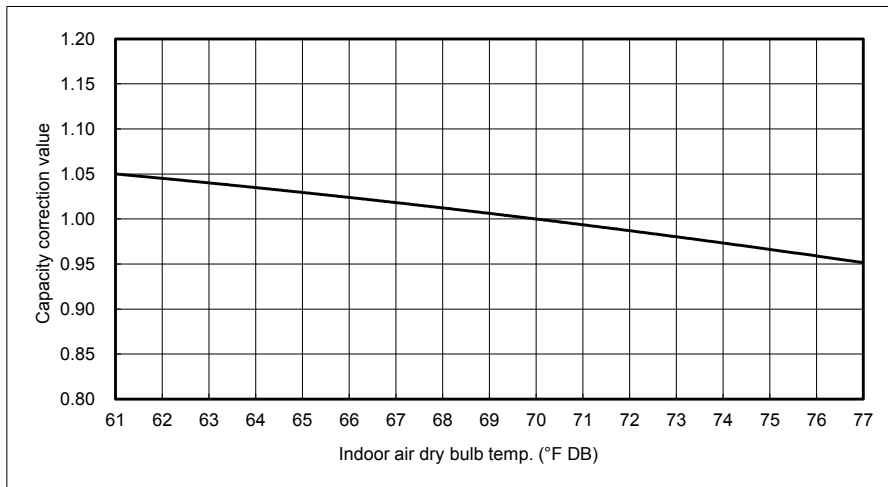

[Chart 2] Outdoor air wet bulb temperature vs. capacity correction value

MMY-MAP__6FT6P-UL / MMY-MAP__6FT9P-UL

○ **Standard**

A	Model type	Capacity type
	Standard	072, 096, 144, 192, 240, 288, 432,
	Space saving	-

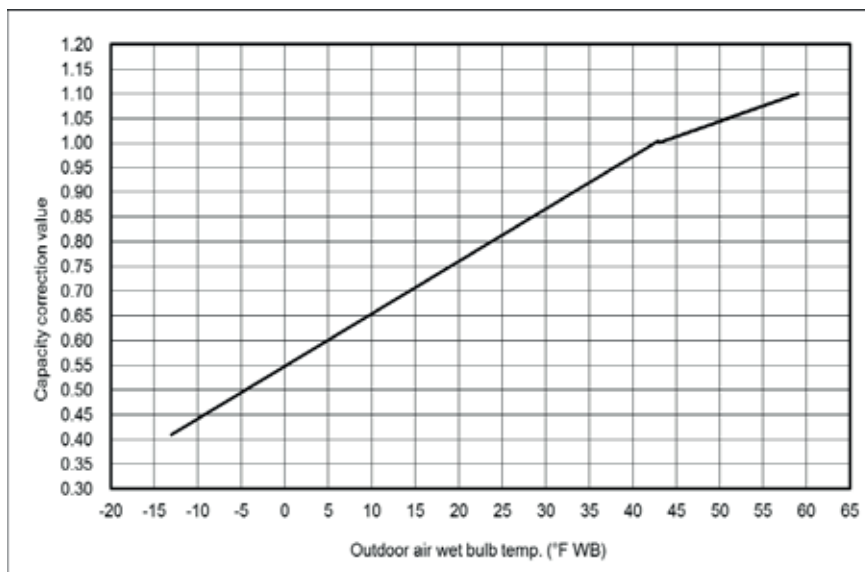



	Model type	Capacity type
B	Standard	120, 168, 216, 264, 312, 336, 360, 284, 408, 456
	Space saving	192S, 240S, 288S, 336S

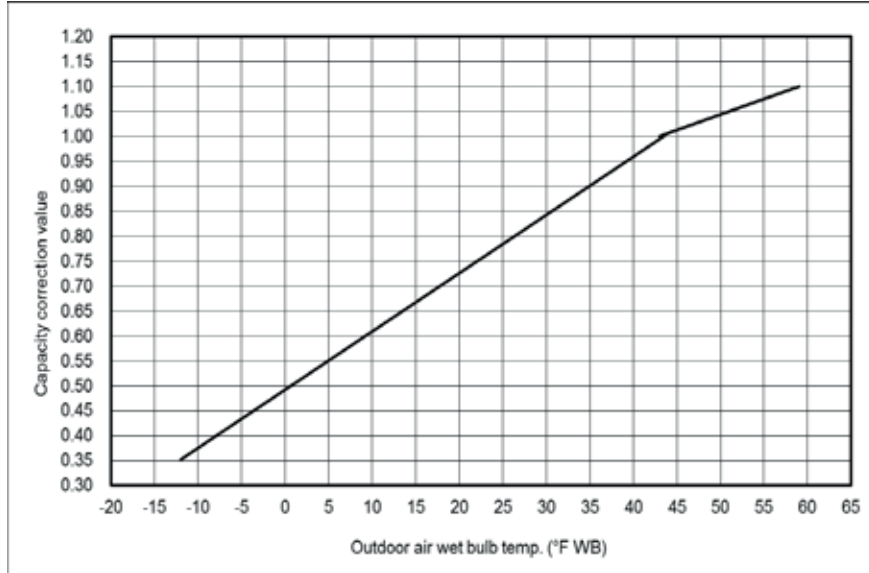

○ **High Heating**

	Model type	Capacity type
A-1	Standard	072, 096, 192,
	Space saving	-

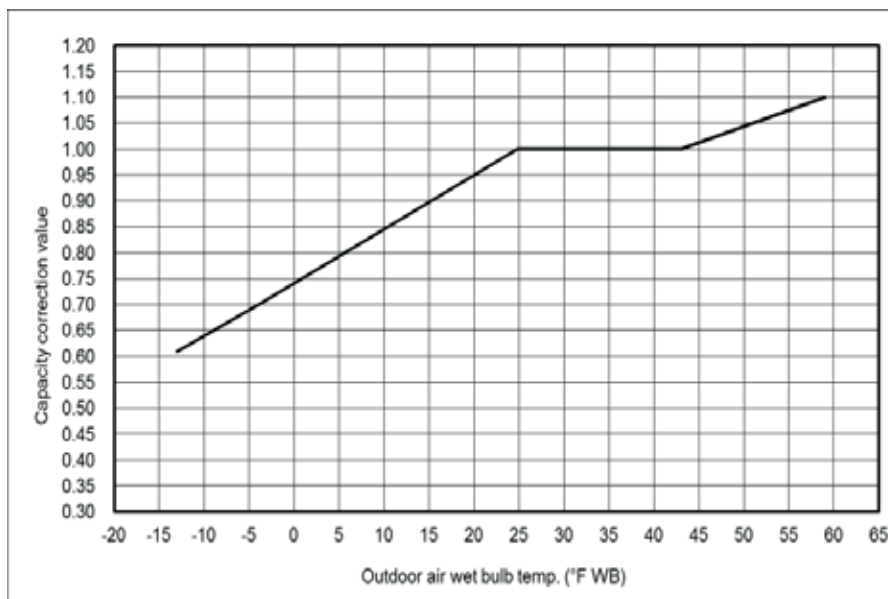



A-2	Model type	Capacity type
	Standard	144, 240, 288, 432
	Space saving	-

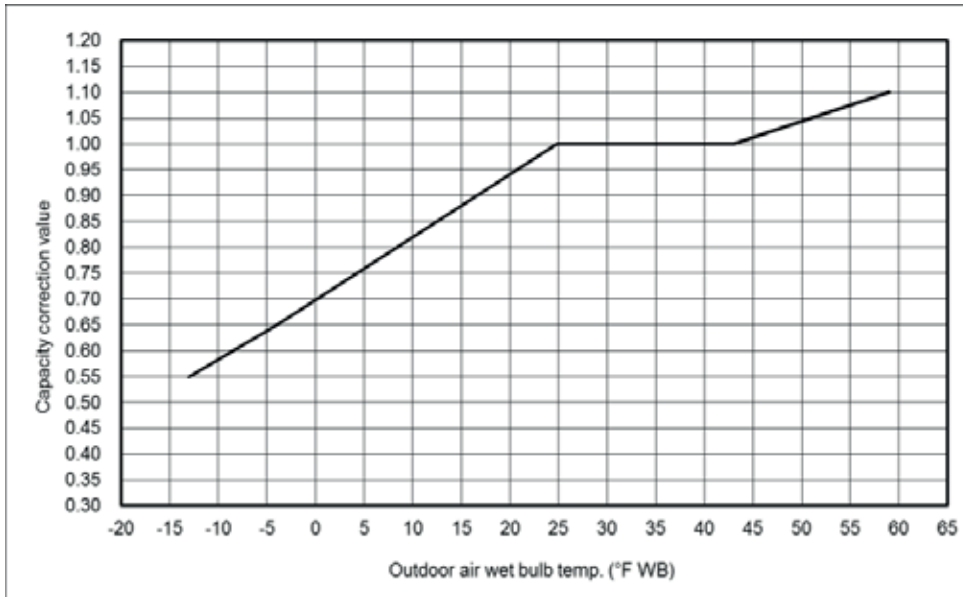

B-1	Model type	Capacity type
	Standard	120, 216, 336, 360
	Space saving	192S, 240S

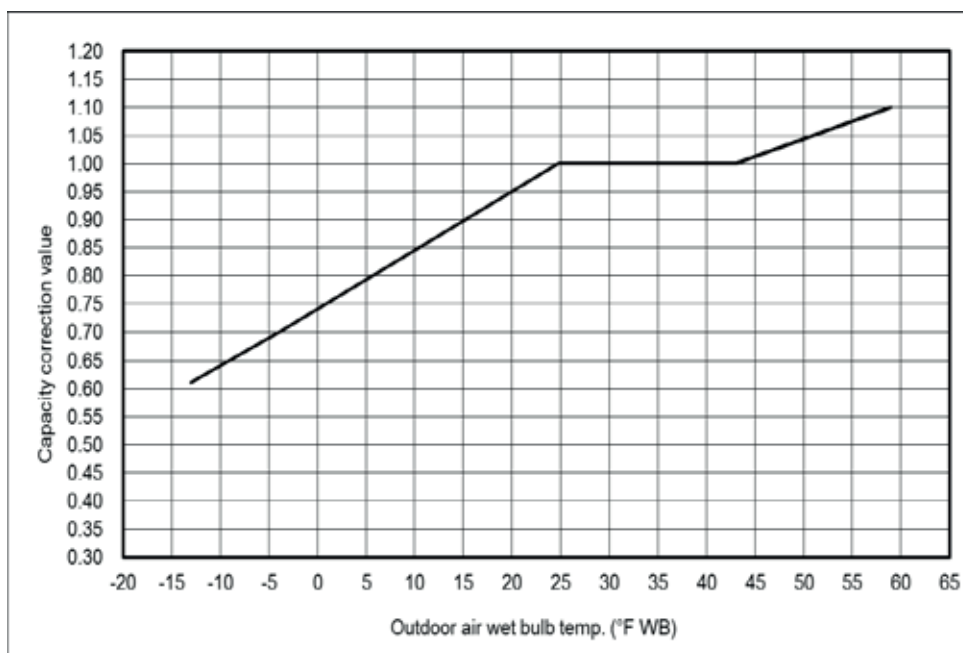



	Model type	Capacity type
B-2	Standard	264, 384, 408
	Space saving	-

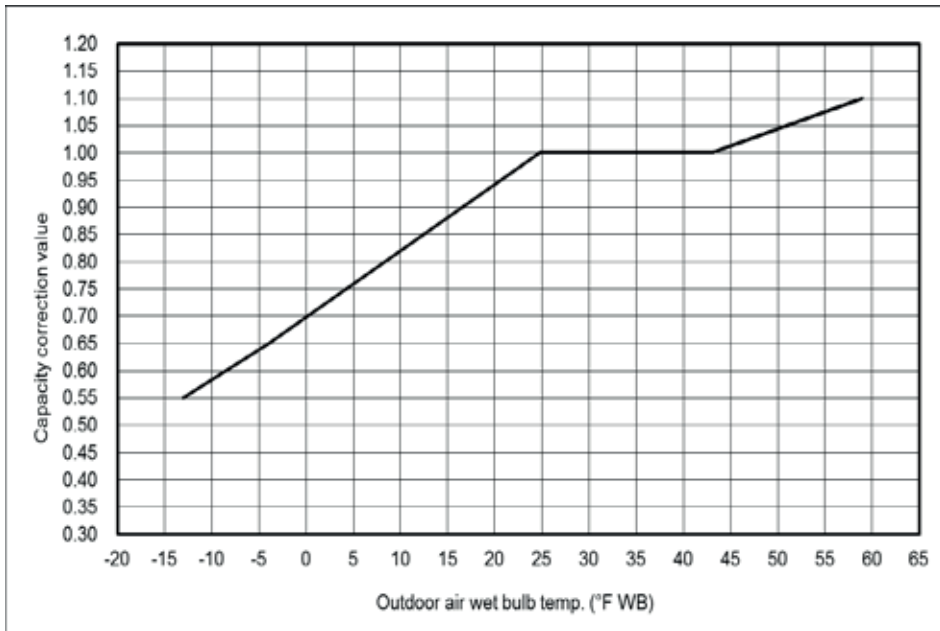

	Model type	Capacity type
B-3	Standard	168, 312, 456
	Space saving	288S, 336S

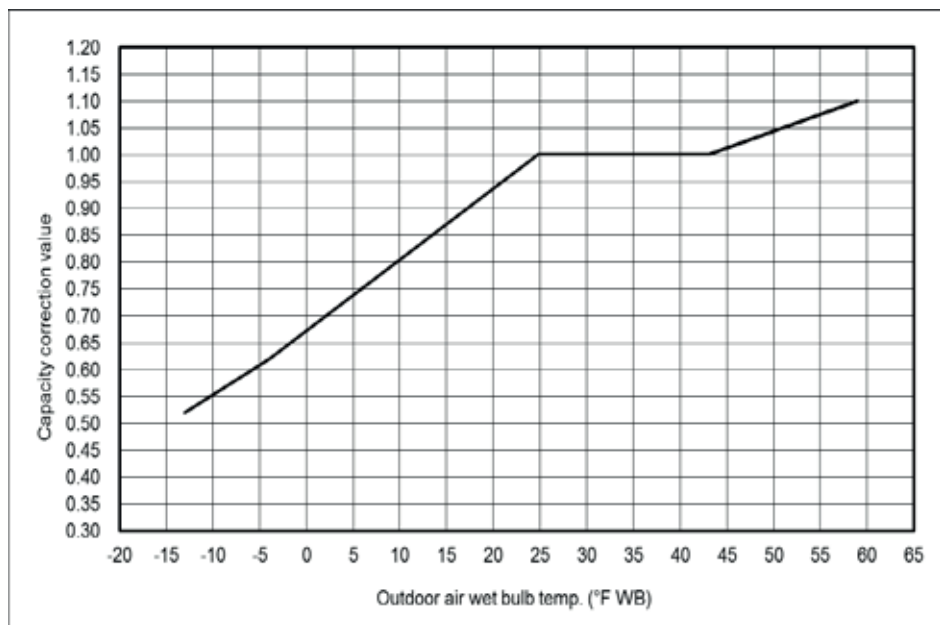



MMY-MAP__6FT2P-UL

○ **Standard**

A	Model type	Capacity type
	Standard	072, 144

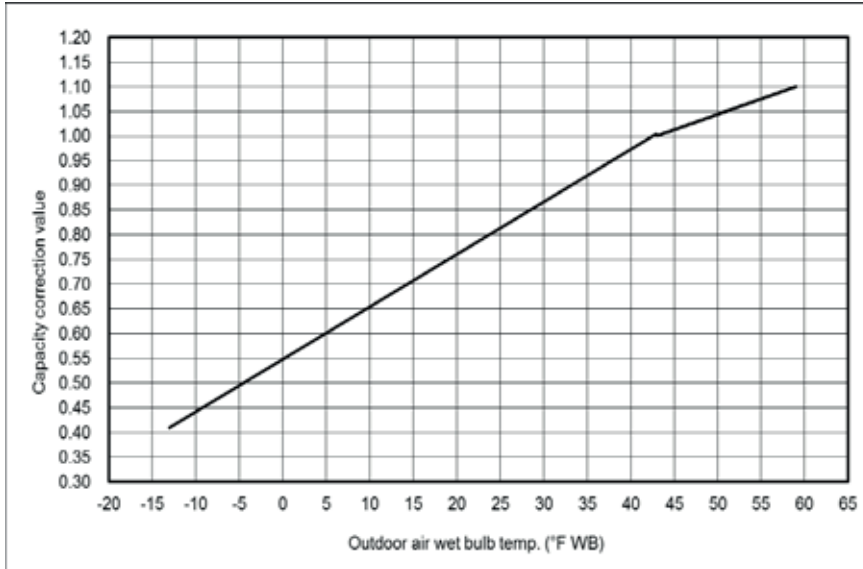

○ **High Heating**

A-1	Model type	Capacity type
	Standard	072, 144

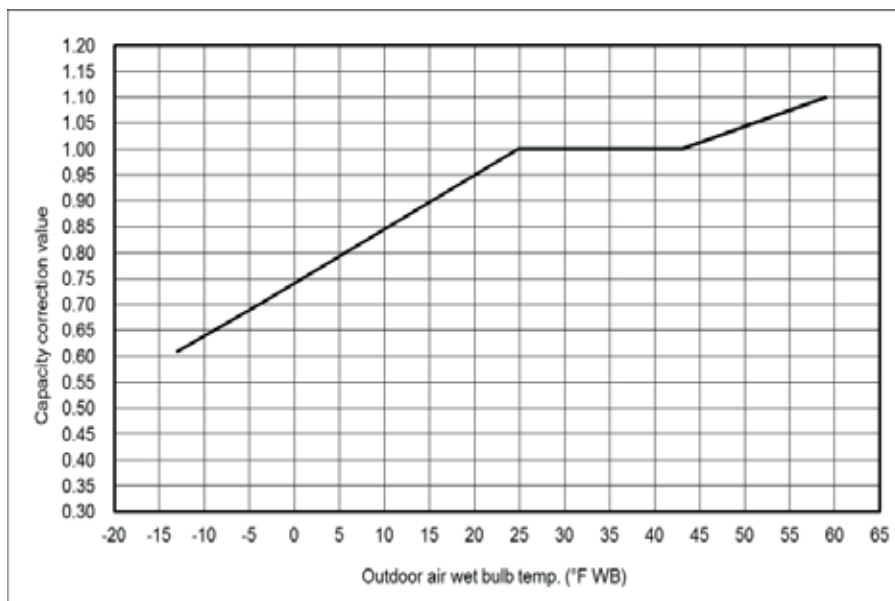



[Chart 3] Connecting pipe length and lift difference between indoor and outdoor units VS. capacity correction value

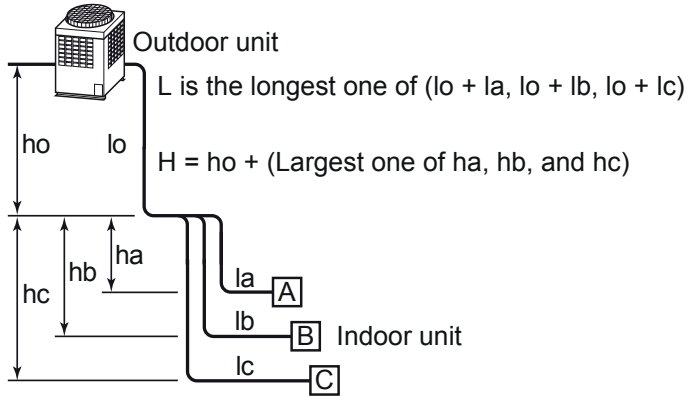

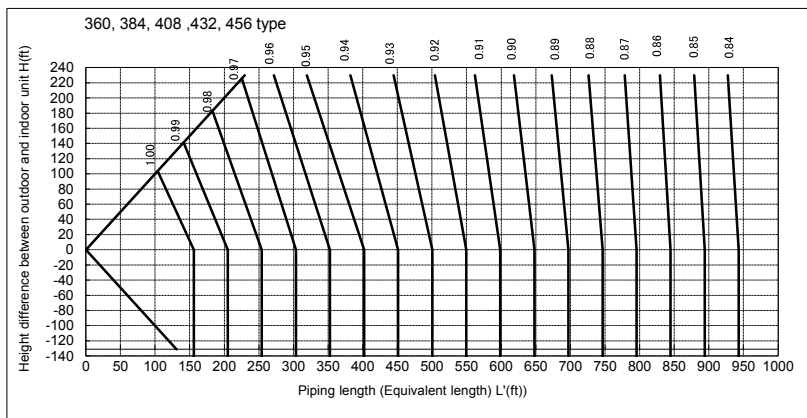
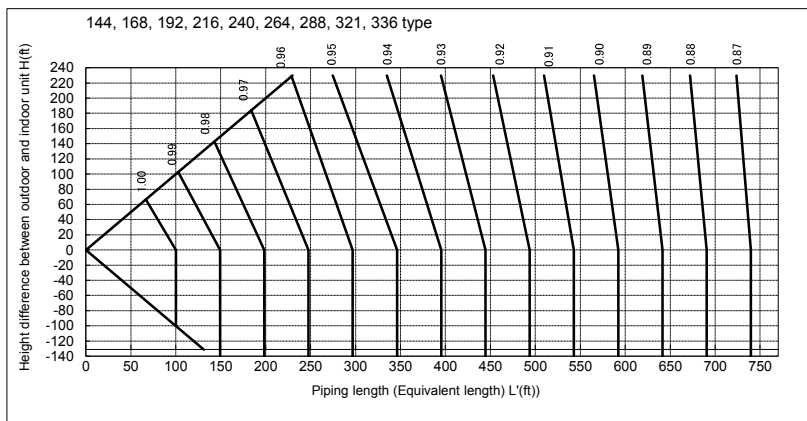
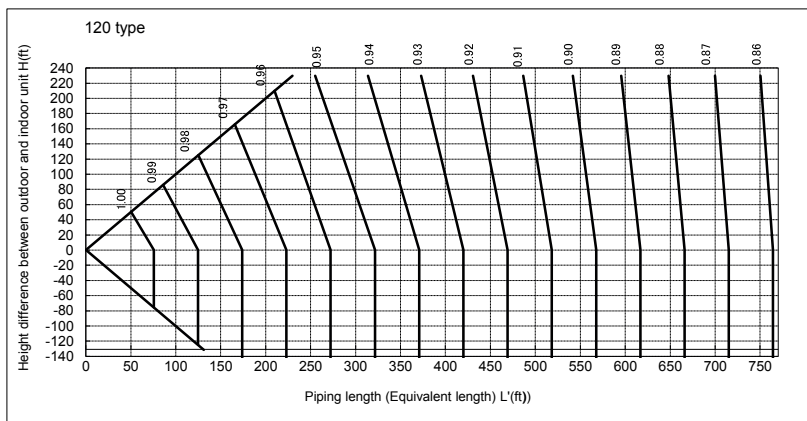
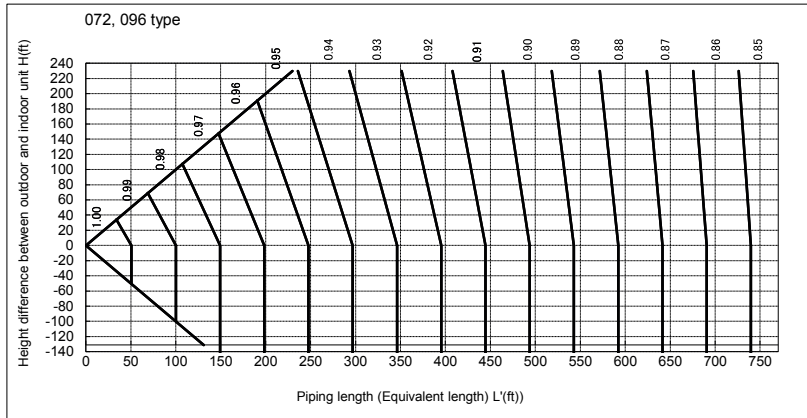



[4]* Correction of outdoor unit diversity

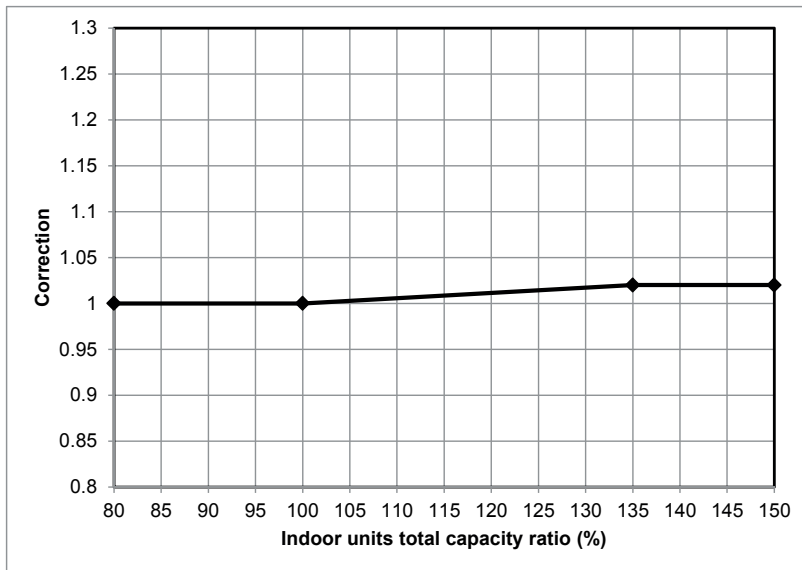

* Coefficient to use for the correction of the outdoor unit capacity when the total capacity of the indoor units are not equal to the outdoor unit capacity.

2-3-3. Capacity correction in case of frost on the outdoor heat exchanger when in heating
 Correct the heating capacity when frost can be found on the outdoor heat exchanger.

[Chart 5] Capacity correction in case of frost on the outdoor heat exchanger

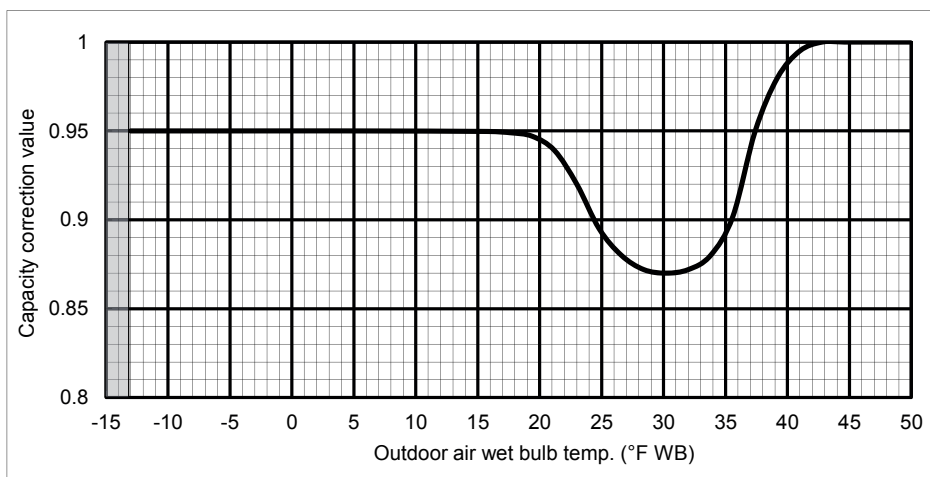



2-4. Operational temperature range

Cooling

Note

1. The cooling performance may be reduced when the cooling demand on the system is less than 3 tons and the ambient temperature is below 23F.

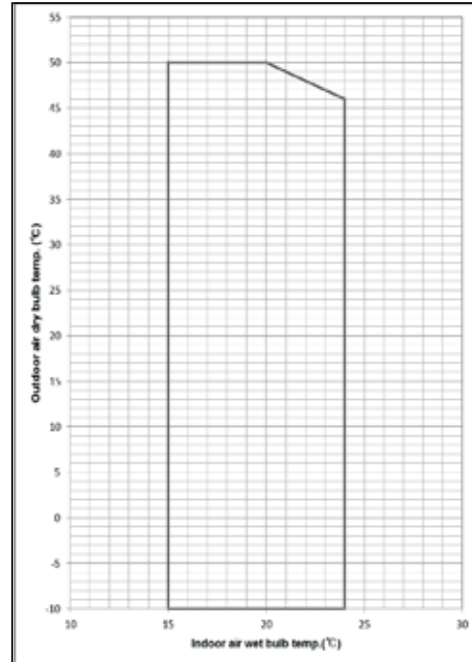

Heating

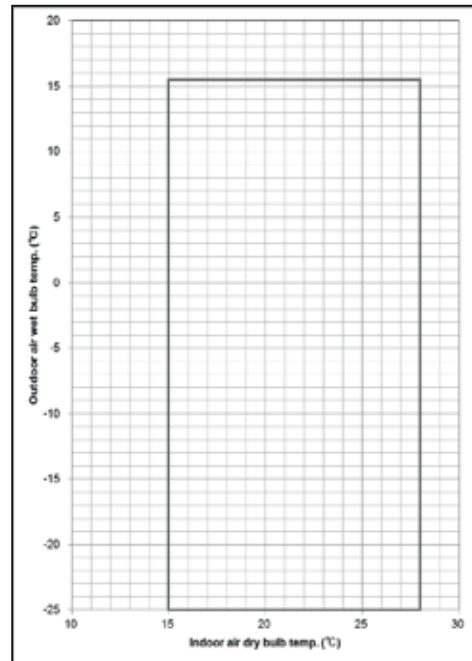
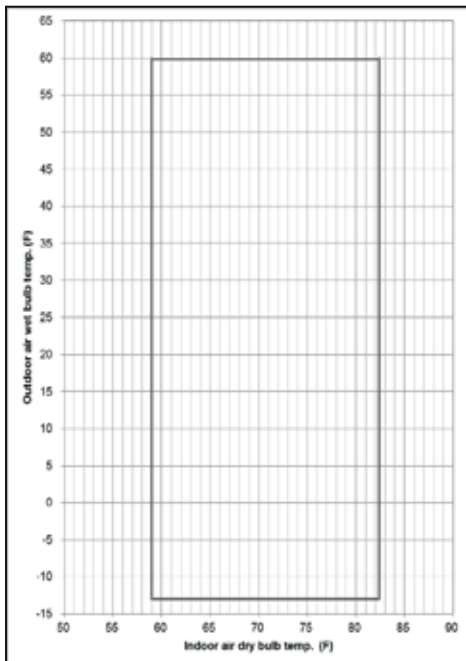



3-1. Free branching system

- [1] Line branching system
- [2] Header branching system
- [3] Header branching system after line branching
- [4] Line branching system after header branching
- [5] Header branching system after header branching
- [6] Multi port type FS unit branching system after line branching
- [7] Line branching system after Multi port type FS unit

The above five branching systems dramatically increase the flexibility of refrigerant piping design.

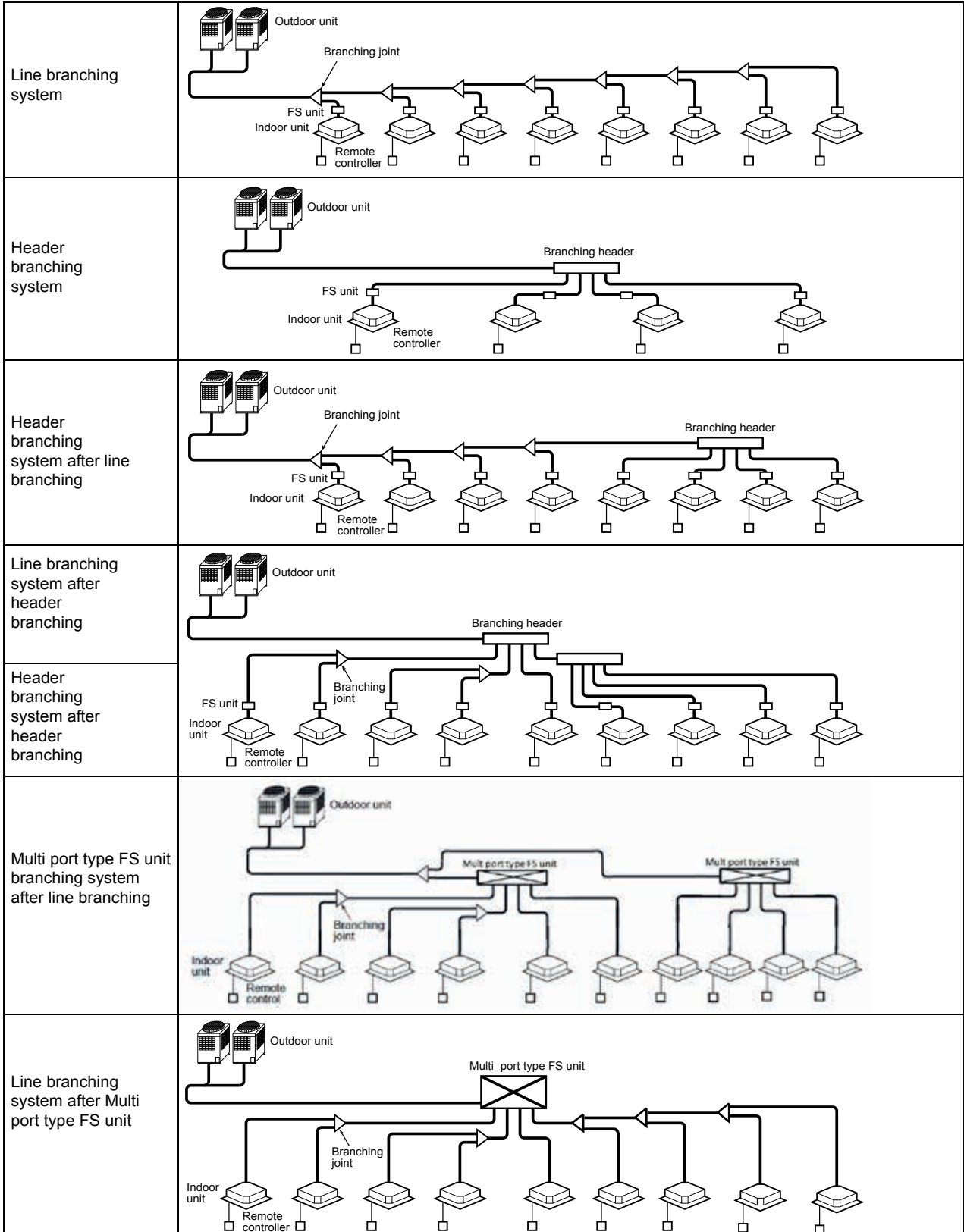



3-2. Allowable length/height difference of refrigerant piping MMY-MAP__6FT6P-UL / MMY-MAP__6FT9P-UL / MMY-MAP__6FT2P-UL

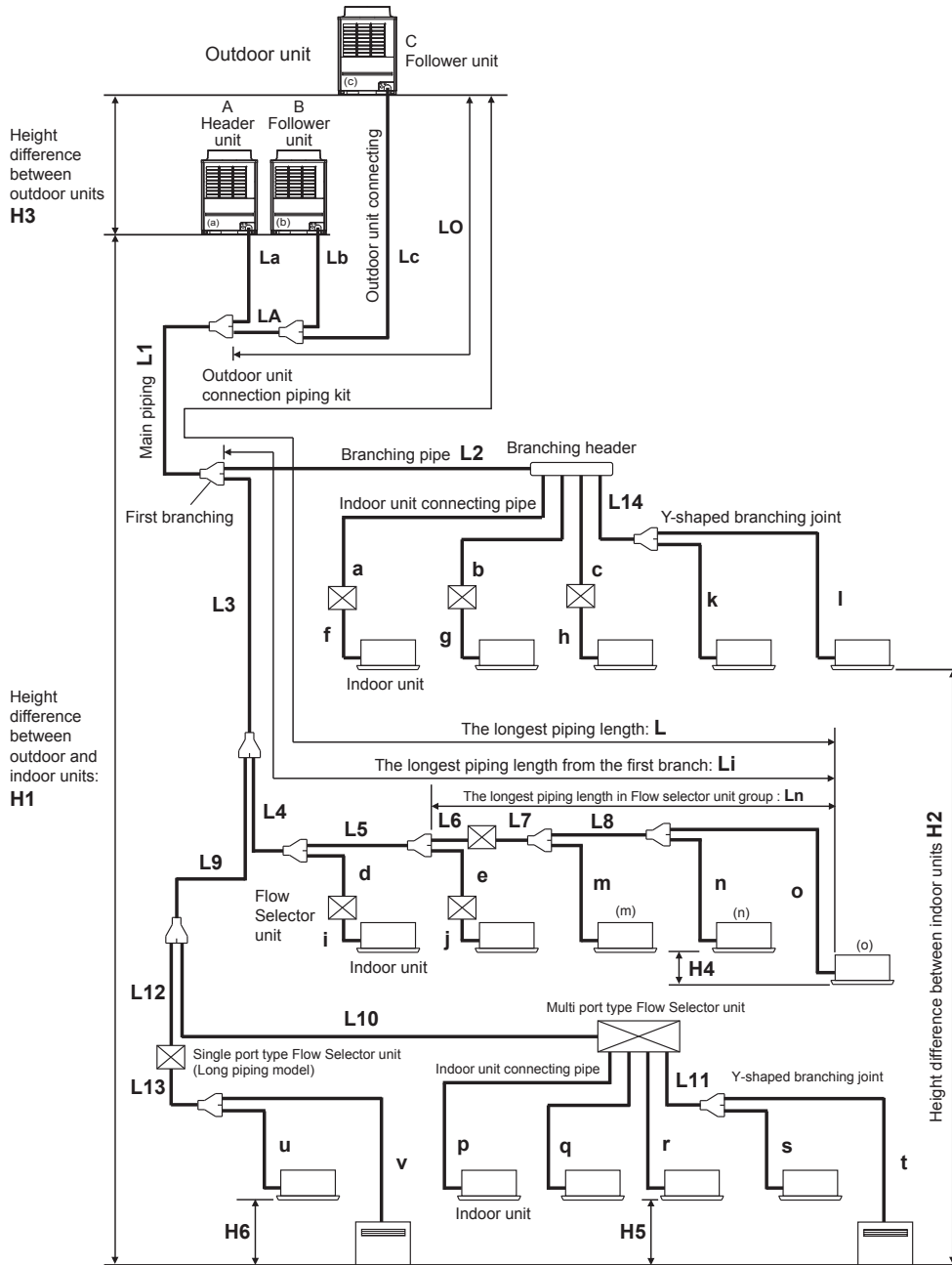

◆ System restriction

Max. No. of combined outdoor units	3 units	
Max. capacity of combined outdoor units	38 ton	
Max. No. of connectable indoor units	64 units (*1)	
Max. capacity of combined indoor units	H2 ≤ 49 ft (15 m)	135% of outdoor units' capacity (*2) 150% of outdoor units' capacity
	H2 > 49 ft (15m)	105% of outdoor units' capacity

(*1) : In case without central control.

It is 54 units in case central control is in system.

(*2) : If the system configure only the limited number of connection indoor unit, total indoor capacity code up to 150% of the outdoor capacity code is available when the height difference between the indoor units is 49ft (15m) or less.

When total indoor capacity code exceeds 135% of outdoor unit capacity code, turn on SW09/Bit2 on I/F P.C. board of outdoor header unit.

◆ Cautions for installation

- Set the outdoor unit first connected to the branching pipe to the indoor units as the header unit.
- Install the outdoor units in order of their capacity codes: (A) header unit ≥ (B) ≥ (C)
- Y-shaped branching joint must be installed horizontally.
- When piping to outdoor units using Outdoor unit connection piping kits, intersect the pipes to the outdoor unit and those to indoor units at a right angle.

For more information, please refer to the Installation Manual.



◆ Allowable length and allowable height difference of refrigerant piping

Item			Allowable value		Pipes			
			(ft)	(m)				
Pipe length	Total extension of pipe (liquid pipe, real length)		3281 (*1)	1000	$LA + La + Lb + Lc + L1 + L2 + L3 + L4 + L5 + L6 + L7 + L8 + L9 + L10 + L11 + L12 + L13 + L14 + a + b + c + d + e + f + g + h + i + j + k + l + m + n + o + p + q + r + s + t + u + v$			
	Farthest piping length L		Equivalent length	656	200	$LA + Lc + L1 + L3 + L4 + L5 + L6 + L7 + L8 + o$ ($LA + Lc + L1 + L3 + L9 + L10 + L11 + t$) ($LA + Lc + L1 + L3 + L9 + L12 + L13 + v$)		
			Real length	591	180			
	Max. length of Main piping		H2 > 9.8 ft		Equivalent length	328	L1	
					Real length	279		85
			H2 ≤ 9.8 ft		Equivalent length	394		120
					Real length	328		100
	Farthest equivalent piping length from the first branch Li		H1 > 9.8 ft		164	50	$L3 + L4 + L5 + L6 + L7 + L8 + o$ ($L3 + L9 + L10 + L11 + t$) ($L3 + L9 + L12 + L13 + v$)	
			H1 ≤ 9.8 ft		213	65		
	Farthest equivalent piping length between outdoor units LO		49	15	LA+Lc (LA+Lb)			
	Maximum equivalent piping length of pipes connected to outdoor units		33	10	Lc (La, Lb)			
	Maximum real length of terminal branching section to indoor units		Single port type		98	30	a + f, b + g, c + h, d + i, e + j, L6+L7+L8+o(Ln)	
			Single port long piping type		328	100	L12 + L13 + u, L12 + L13 + v	
			Multi port type		328	100	L10 + p, L10 + q, L10 + r, L10 + L11 + s, L10 + L11 + t	
Without Flow Selector unit			98	30	k, l			
Maximum real length of between Flow Selector unit and indoor unit		Single port type		49	15	f, g, h, i, j, L7 + L8 + o		
		Single port long piping type		164	50	L13 + u, L13 + v		
		Multi port type		(*2) (*3)		p, q, r, L11 + s, L11 + t		
Maximum equivalent length between branching section		164	50	L2, L3, L4, L5, L9, L10, L12				
Height difference	Height between outdoor and indoor units H1		Upper outdoor units		230 (*4) (*5)	70	—	
			Lower outdoor units		98	30	—	
	Height between indoor units H2		Upper outdoor units		131	40	—	
			Lower outdoor units (*6)		49 (*7)	15	—	
	Height between outdoor units H3 (*8)		16	5	—			
	Height difference between indoor unit in one Flow Selector unit		Single port type H4		1.6	0.5	—	
			Single port long piping type H6		9.8	3	—	
			Multi port type H5		9.8	3	—	

(*1) : Total refrigerant amount in the system is restricted according to capacity type. Refer to the table below.

(*2) : The total piping length in one Multi port type FS unit in case of branching to 4 : 394 ft (p+q+r+L11+s+t), in case of branching to 6 : 590 ft.

(*3) : Total length of pipe should be less than 164 ft per branch(L11+s+t, L13+u+v).

(*4) : If the height difference (H2) between indoor units exceeds 9.8 ft, set 164 ft or less.

(*5) : Extension up to 295 ft is possible, please contact manufacturer's representative for review.

(*6) : In case the system capacity is greater than 22ton, it is 9.8 ft. Up to 49 ft is possible, please contact manufacturer's representative for review.

(*7) : Extension up to 98 ft is possible, please contact manufacturer's representative for review.

(*8) : Ensure that the header unit is installed below all connected follower outdoor unit(s).

Possible product failure may occur if header unit is installed above any follower unit(s).

Capacity type	072	096	120	144	168	192	216	240	264	288	312	336	360	384	408	432	456
Applicable total refrigerant amount (lbs)	88	132	132	198	198	220	220	287	287	287	287	308	308	308	308	308	308

3-3. Selection of refrigerant piping

MMY-MAP_6FT6P-UL / MMY-MAP_6FT9P-UL / MMY-MAP_6FT2P-UL

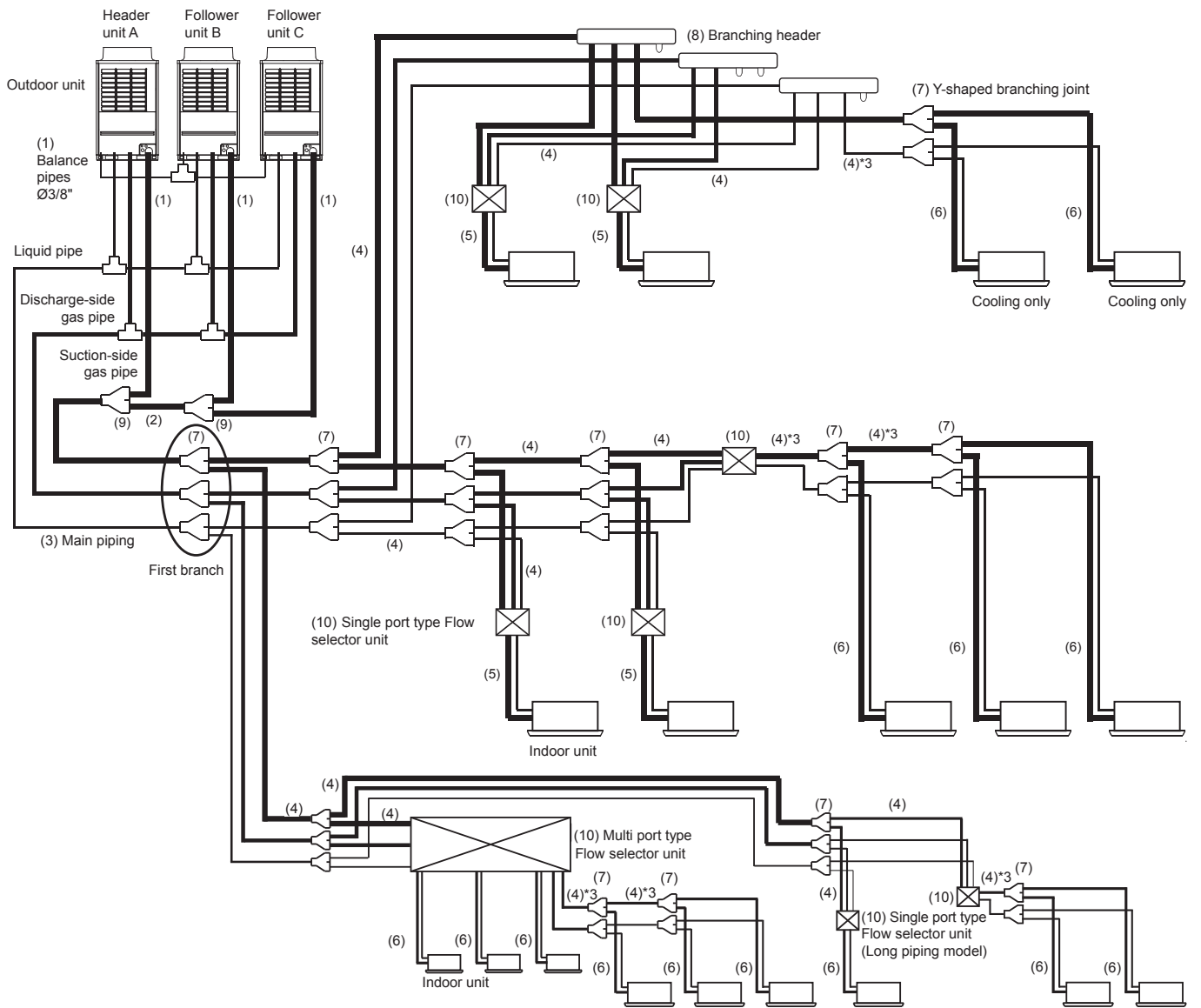



① Outdoor unit connecting pipe

Outdoor unit capacity type (*1)	Balance pipe side	Suction gas side	Discharge gas side	Liquid side
072 type, 096 type	φ3/8"	φ7/8"	φ3/4"	φ1/2"
120 type	φ3/8"	φ1-1/8"	φ3/4"	φ1/2"
144 type	φ3/8"	φ1-1/8"	φ7/8"	φ5/8"
168 type	φ3/8"	φ1-1/8"	φ7/8"	φ3/4"

② Pipe between Outdoor Unit Connection Piping Kits (*9)

Total capacity code of the outdoor units at downstream side (*1)	Suction gas side	Discharge gas side	Liquid side
336	φ1-3/8"	φ1-1/8"	φ7/8"
360 or more	φ1-5/8"	φ1-1/8"	φ7/8"

③ Main pipe

Total capacity code of all outdoor units	Suction gas side	Discharge gas side	Liquid side
072, 096	Ø7/8"	Ø3/4"	Ø1/2"
120	φ1-1/8"	Ø3/4"	Ø1/2"
144	φ1-1/8"	φ7/8"	φ5/8"
168, 192	φ1-1/8"	φ7/8"	φ3/4"
216, 240	φ1-3/8"	φ1-1/8"	φ3/4"
264, 288, 312, 336	φ1-3/8"	φ1-1/8"	φ7/8"
360 or more	φ1-5/8"	φ1-3/8"	φ7/8"

④ Branching pipe

Total capacity code of indoor units at downstream side (*1 *2 *3)	Suction gas side	Discharge gas side	Liquid side
Below 61	Ø5/8"	Ø1/2"	Ø3/8"
61 to below 115.5	Ø7/8"	Ø3/4"	Ø1/2"
115.5 to below 153.5	Ø1-1/8"	Ø7/8"	Ø5/8"
153.5 to below 191.5	Ø1-1/8"	Ø7/8"	Ø3/4"
191.5 to below 239	Ø1-3/8"	Ø1-1/8"	Ø3/4"
239 to below 334	Ø1-3/8"	Ø1-1/8"	Ø7/8"
334 or more	Ø1-5/8"	Ø1-3/8"	Ø7/8"

⑤ FS unit and indoor unit connection pipe

Indoor unit capacity code	Gas side	Liquid side
007 to 012 type	Ø3/8"	Ø1/4"
015 to 018 type	Ø1/2"	Ø1/4"
021 to 054 type	Ø5/8"	Ø3/8"
072 to 096 type	Ø7/8"	Ø1/2"

⑥ Branching and indoor unit connection pipe

Indoor unit capacity code		Gas side	Liquid side
007 to 012 type	Pipe length (Actual length) 49 ft or less	Ø3/8"	Ø1/4"
	Over 49 ft	Ø1/2"	Ø3/8"
015 to 018 type	Pipe length (Actual length) 49 ft or less	Ø1/2"	Ø1/4"
	Over 49 ft	Ø5/8"	Ø3/8"
021 to 054 type		Ø5/8"	Ø3/8"
072 to 096 type		Ø7/8"	Ø1/2"

⑦ Y-shaped branching joint (*3, *4)

Total capacity code of indoor units on downstream side from Y-shaped branching joint (*4 *5)	Model name
Below 61	RBM-BY55FUL
61 to below 134.5	RBM-BY105FUL
134.5 to below 239	RBM-BY205FUL
239 or more	RBM-BY305FUL

⑧ Branching header

Total capacity code of the indoor units on downstream side from branching header (*4 *5 *6)	Model name	
For 4 branching	Below 134	RBM-HY1043FUL
	134 to below 240	RBM-HY2043FUL
For 8 branching	Below 134	RBM-HY1083FUL
	134 to below 240	RBM-HY2083FUL

⑨ Outdoor unit connection piping kit

Total capacity code of the outdoor units at downstream side (*1)	Model name
Below 247	RBM-BT14FUL
247 or more	RBM-BT24FUL

⑩ Flow Selector unit (*7)

Single port type(*8) / single port long piping type(*9)

Total capacity code of outdoor units on downstream side from FS unit	Model name
Below 38	RBM-Y0383FUL / RBM-Y0384FUL
38 to below 61	RBM-Y0613FUL / RBM-Y0614FUL
61 to 96 or less	RBM-Y0963FUL / RBM-Y0964FUL

Multi port type(*9)

Total capacity code of the outdoor units on downstream side from FS unit	No. of branch	Model name
Below 61	4	RBM-Y0611F4PUL
	6	RBM-Y0611F6PUL

◆ CAUTION ◆

Please use the appropriate pipe when the pipe size is φ3/4 or more.

Outer diameter		Minimum wall thickness	Temper	
Inch	mm		Soft	Hard, Semi hard
φ1/4"	6.35	0.80	OK	OK
φ3/8"	9.52	0.80	OK	OK
φ1/2"	12.7	1.00	OK	OK
φ5/8"	15.88	1.00	OK	OK
φ3/4"	19.05	1.00	NG	OK
φ7/8"	22.2	1.00	NG	OK
φ1-1/8"	28.58	1.00	NG	OK
φ1-3/8"	34.92	1.20	NG	OK
φ1-5/8"	41.28	1.40	NG	OK

*1: The capacity code of outdoor unit and indoor unit, please refer to "◆Capacity code of indoor and outdoor units".

*2: If the size of the pipe to be selection is larger than the size of the main pipe, please use the same pipe size as the main pipe.

*3: Two pipes in downstream of FS unit and cooling only indoor unit use liquid pipe and suction gas pipe.

*4: The first branching joint, select at capacity code of outdoor unit.

*5: If the total capacity code of indoor unit exceed the capacity code of outdoor unit, select the size from the capacity code of the outdoor unit.

*6: For one line pipe of header branching, total 57 capacity code of indoor units is connectable.

If connecting the branching header to the first branch section with the capacity code of outdoor unit is more than 114 (kBtu/h) and less than 247 (kBtu/h), use the RBM-2043FUL (4branch), and RBM-HY2043FUL (8branch). Also, the branching header can not be used for the first branch section when the capacity code of outdoor unit is more than 247 (kBtu/h).

*7: If the code of outdoor unit is over 408, "Flow Selector unit" is available for only Multi port type and Single port long piping type.

*8: The group connection of the multiple indoor units is possible up to maximum 8 units, and it is possible only within one FS unit.

*9: The group connection of the multiple indoor units is possible up to 8 units if one remote controller is used, and it is possible up to 7 units if two remote controllers are used. The group connection of the multiple indoor units is possible only within one branch.



3-4. Charging requirement with additional refrigerant

MMY-MAP__6FT6P-UL / MMY-MAP__6FT9P-UL

After the system has been vacuumed, replace the vacuum pump with a refrigerant cylinder and system with additional refrigerant.

Calculating the amount of additional refrigerant required

Refrigerant in the system when shipped from the factory

Model name		Refrigerant amount charged in factory
MMY-MAP	0726FT6P-UL	24.3lbs
	0966FT6P-UL	
	1206FT6P-UL	
	1446FT6P-UL	
	1686FT6P-UL	

When the system is charged with refrigerant at the factory, the amount of refrigerant needed for the pipes at the site is not included. Therefore, calculate the additional amount needed and add the required amount to the system.

(Calculation of Heat recovery)

Additional refrigerant charge amount is calculated based on the size of liquid pipe at site and its real length.

$$\text{Additional refrigerant charge amount (lbs)} = \left[\text{Actual length of liquid pipe} \right] \times \left[\text{Additional refrigerant charge amount per liquid pipe 1 ft [Table 1]} \right] \times 1.3 + \text{Adjustment amount of refrigerant [Table 2]}$$

Table 1

Liquid pipe outer diameter (in)	Ø1/4"	Ø3/8"	Ø1/2"	Ø5/8"	Ø3/4"	Ø7/8"
Additional refrigerant amount/1 ft (lbs)	0.017	0.037	0.071	0.108	0.168	0.235

Table 2

Outdoor unit capacity type	Adjustment amount of refrigerant(lbs)	Applicable total refrigerant amount(lbs)	Combined outdoor units		
072 type	4.4	88	072 type		
096 type	6.6	132	096 type		
120 type	17.6	132	120 type		
144 type	24.3	198	144 type		
168 type	30.9	198	168 type		
192 type	8.8	220	096 type	096 type	
216type	13.2	220	120 type	096 type	
240 type	22.1	287	144 type	096 type	
264 type	26.5	287	144 type	120 type	
288 type	30.9	287	144 type	144 type	
312 type	33.1	287	168 type	144 type	
336 type	13.2	308	120 type	120 type	096 type
360 type	24.3	308	120 type	120 type	120 type
384 type	28.7	308	144 type	120 type	120 type
408 type	30.9	308	144 type	144 type	120 type
432 type	33.1	308	144 type	144 type	144 type
456 type	37.5	308	168 type	144 type	144 type

Space saving model

192 type	8.8	220	120 type	072 type	
240 type	22.1	287	120 type	120 type	
288 type	30.9	287	168 type	120 type	
336 type	37.5	308	168 type	168 type	

Note : Applicable total refrigerant amount in the system is restricted according to outdoor unit capacity code.



MMY-MAP__6FT2P-UL

After the system has been vacuumed, replace the vacuum pump with a refrigerant cylinder and system with additional refrigerant.

Calculating the amount of additional refrigerant required

Refrigerant in the system when shipped from the factory

Model name	Refrigerant amount charged in factory
MMY-MAP0726FT2P-UL	24.3lbs

When the system is charged with refrigerant at the factory, the amount of refrigerant needed for the pipes at the site is not included. Therefore, calculate the additional amount needed and add the required amount to the system.

(Calculation of Heat recovery)

Additional refrigerant charge amount is calculated based on the size of liquid pipe at site and its real length.

$$\text{Additional refrigerant charge amount (lbs)} = \left[\text{Actual length of liquid pipe} \right] \times \left[\text{Additional refrigerant charge amount per liquid pipe 1 ft [Table 1]} \right] \times 1.3 + \text{Adjustment amount of refrigerant [Table 2]}$$

Table 1

Liquid pipe outer diameter (in)	Ø 1/4"	Ø 3/8"	Ø 1/2"	Ø 5/8"
Additional refrigerant amount/1 ft (lbs)	0.017	0.037	0.071	0.108

Table 2

Outdoor unit capacity type	Adjustment amount of refrigerant(lbs)	Applicable total refrigerant amount(lbs)	Combined outdoor units	
072 type	4.4	88	072 type	
144 type	6.6	198	072 type	072 type

Note : Applicable total refrigerant amount in the system is restricted according to outdoor unit capacity code.



4-1. General

- The equipment shall be installed in compliance with NEC and local codes.
- Do not connect high voltage power wires to the control terminal blocks (U1, U2, U3, U4, U5, U6).
- All field wiring insulation rating must comply with NEC and local codes.
- All wiring must be strained relieved as specified by NEC and local codes.
- Do not energize indoor units until leak checked and vacuuming is complete.
- Use copper supply wires only.
- Use wiring with insulation rated for the highest voltage involved for communication and power wiring.

4-2. Outdoor unit power supply

4-2-1. MMY-MAP__6FT6P-UL / MMY-MAP__6FT9P-UL

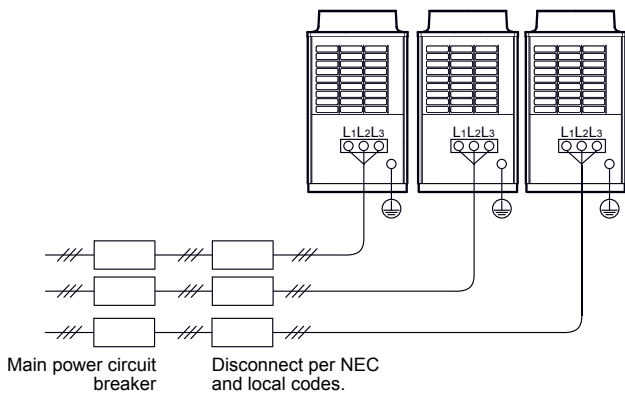

Every outdoor unit must have a dedicated power supply.

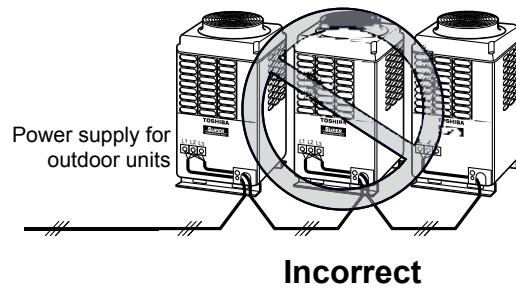

Outdoor unit data

3 Phase 208/230V model

Single outdoor unit

ton	Heat Recovery Model MMY-	Power Supply		Voltage Range		Output				MCA	MOCP
						Compressor			Fan Motor		
		Phase and frequency	Nominal Voltage	Min (V)	Max (V)	Unit No.1 (kW)	Unit No.2 (kW)	Unit No.3 (kW)			
6	MAP0726FT9P-UL	3Ph 60Hz	208/230 V	187	253	2.1x2			1.0	23.3	30
8	MAP0966FT9P-UL	3Ph 60Hz	208/230 V	187	253	3.0x2			1.0	34.2	40
10	MAP01206FT9P-UL	3Ph 60Hz	208/230 V	187	253	4.0x2			1.0	45.4	50
12	MAP1446FT9P-UL	3Ph 60Hz	208/230 V	187	253	5.4x2			1.0+1.0	52.1	60
14	MAP1686FT9P-UL	3Ph 60Hz	208/230 V	187	253	6.5x2			1.0+1.0	66.2	70

Combination of outdoor unit

ton	Heat Recovery Model MMY-	Power Supply		Voltage Range		Output				MCA	MOCP
						Compressor			Fan Motor		
		Phase and frequency	Nominal Voltage	Min (V)	Max (V)	Unit No.1 (kW)	Unit No.2 (kW)	Unit No.3 (kW)			
16	AP1926FT9P-UL	3Ph 60Hz	208/230 V	187	253	3.0x2	3.0x2		1.0+1.0	34.2 + 34.2	40 + 40
18	AP2166FT9P-UL	3Ph 60Hz	208/230 V	187	253	4.0x2	3.0x2		1.0+1.0	45.4 + 34.2	50 + 40
20	AP2406FT9P-UL	3Ph 60Hz	208/230 V	187	253	5.4x2	3.0x2		1.0+1.0+1.0	52.1 + 34.2	60 + 40
22	AP2646FT9P-UL	3Ph 60Hz	208/230 V	187	253	5.4x2	4.0x2		1.0+1.0+1.0	52.1 + 45.4	60 + 50
24	AP2886FT9P-UL	3Ph 60Hz	208/230 V	187	253	5.4x2	5.4x2		1.0+1.0+1.0+1.0	52.1 + 52.1	60 + 60
26	AP3126FT9P-UL	3Ph 60Hz	208/230 V	187	253	6.5x2	5.4x2		1.0+1.0+1.0+1.0	66.2 + 52.1	70 + 60
28	AP3366FT9P-UL	3Ph 60Hz	208/230 V	187	253	4.0x2	4.0x2	3.0x2	1.0+1.0+1.0	45.4 + 45.4 + 34.2	50 + 50 + 40
30	AP3606FT9P-UL	3Ph 60Hz	208/230 V	187	253	4.0x2	4.0x2	4.0x2	1.0+1.0+1.0	45.4 + 45.4 + 45.4	50 + 50 + 50
32	AP3846FT9P-UL	3Ph 60Hz	208/230 V	187	253	5.4x2	4.0x2	4.0x2	1.0+1.0+1.0+1.0	52.1 + 45.4 + 45.4	60 + 50 + 50
34	AP4086FT9P-UL	3Ph 60Hz	208/230 V	187	253	5.4x2	5.4x2	4.0x2	1.0+1.0+1.0+1.0+1.0	52.1 + 52.1 + 45.4	60 + 60 + 50
36	AP4326FT9P-UL	3Ph 60Hz	208/230 V	187	253	5.4x2	5.4x2	5.4x2	1.0+1.0+1.0+1.0+1.0+1.0	52.1 + 52.1 + 52.1	60 + 60 + 60
38	AP4566FT9P-UL	3Ph 60Hz	208/230 V	187	253	6.5x2	5.4x2	5.4x2	1.0+1.0+1.0+1.0+1.0+1.0	66.2 + 52.1 + 52.1	70 + 60 + 60
16	AP192S6FT9P-UL	3Ph 60Hz	208/230 V	187	253	4.0x2	2.1x2		1.0+1.0	45.4 + 23.3	50 + 30
20	AP240S6FT9P-UL	3Ph 60Hz	208/230 V	187	253	4.0x2	4.0x2		1.0+1.0	45.4 + 45.4	50 + 50
24	AP288S6FT9P-UL	3Ph 60Hz	208/230 V	187	253	6.5x2	4.0x2		1.0+1.0+1.0	66.2 + 45.4	70 + 50
28	AP336S6FT9P-UL	3Ph 60Hz	208/230 V	187	253	6.5x2	5.4x2		1.0+1.0+1.0+1.0	66.2 + 66.2	70 + 70

Notes MCA :Minimum Circuit Amps
MOCP :Maximum Overcurrent Protection(Amps)



3 Phase 460V model Single outdoor unit

ton	Heat Recovery Model MMY-	Power Supply		Voltage Range		Output			MCA	MOCP	
						Compressor					Fan Motor
						Unit No.1	Unit No.2	Unit No.3			
		Phase and frequency	Nominal Voltage	Min (V)	Max (V)	(kW)	(kW)	(kW)	(A)	(A)	
6	MAP0726FT6P-UL	3Ph 60Hz	460V	414	506	2.1x2			1.0	11.8	15
8	MAP0966FT6P-UL	3Ph 60Hz	460V	414	506	3.0x2			1.0	17.0	20
10	MAP01206FT6P-UL	3Ph 60Hz	460V	414	506	4.0x2			1.0	22.0	25
12	MAP1446FT6P-UL	3Ph 60Hz	460V	414	506	5.4x2			1.0+1.0	23.4	30
14	MAP1686FT6P-UL	3Ph 60Hz	460V	414	506	6.5x2			1.0+1.0	29.7	35

Combination of outdoor unit

ton	Heat Recovery Model MMY-	Power Supply		Voltage Range		Output			MCA	MOCP	
						Compressor					Fan Motor
						Unit No.1	Unit No.2	Unit No.3			
		Phase and frequency	Nominal Voltage	Min (V)	Max (V)	(kW)	(kW)	(kW)	(A)	(A)	
16	AP1926FT6P-UL	3Ph 60Hz	460V	414	506	3.0x2	3.0x2		1.0+1.0	17 + 17	20 + 20
18	AP2166FT6P-UL	3Ph 60Hz	460V	414	506	4.0x2	3.0x2		1.0+1.0	22 + 17	25 + 20
20	AP2406FT6P-UL	3Ph 60Hz	460V	414	506	5.4x2	3.0x2		1.0+1.0+1.0	23.4 + 17	30 + 20
22	AP2646FT6P-UL	3Ph 60Hz	460V	414	506	5.4x2	4.0x2		1.0+1.0+1.0	23.4 + 22	30 + 25
24	AP2886FT6P-UL	3Ph 60Hz	460V	414	506	5.4x2	5.4x2		1.0+1.0+1.0+1.0	23.4 + 23.4	30 + 30
26	AP3126FT6P-UL	3Ph 60Hz	460V	414	506	6.5x2	5.4x2		1.0+1.0+1.0+1.0	29.7 + 23.4	35 + 30
28	AP3366FT6P-UL	3Ph 60Hz	460V	414	506	4.0x2	4.0x2	3.0x2	1.0+1.0+1.0	22 + 22+ 17	25 + 25+ 20
30	AP3606FT6P-UL	3Ph 60Hz	460V	414	506	4.0x2	4.0x2	4.0x2	1.0+1.0+1.0	22 + 22+ 22	25 + 25+ 25
32	AP3846FT6P-UL	3Ph 60Hz	460V	414	506	5.4x2	4.0x2	4.0x2	1.0+1.0+1.0+1.0	23.4 + 22+ 22	30 + 25+ 25
34	AP4086FT6P-UL	3Ph 60Hz	460V	414	506	5.4x2	5.4x2	4.0x2	1.0+1.0+1.0+1.0+1.0	23.4 + 23.4+ 22	30 + 30+ 25
36	AP4326FT6P-UL	3Ph 60Hz	460V	414	506	5.4x2	5.4x2	5.4x2	1.0+1.0+1.0+1.0+1.0+1.0	23.4 + 23.4+ 23.4	30 + 30+ 30
38	AP4566FT6P-UL	3Ph 60Hz	460V	414	506	6.5x2	5.4x2	5.4x2	1.0+1.0+1.0+1.0+1.0+1.0	29.7 + 23.4+ 23.4	35 + 30+ 30
16	AP192S6FT6P-UL	3Ph 60Hz	460V	414	506	4.0x2	2.1x2		1.0+1.0	22 + 11.8	25 + 15
20	AP240S6FT6P-UL	3Ph 60Hz	460V	414	506	4.0x2	4.0x2		1.0+1.0	22 + 22	25 + 25
24	AP288S6FT6P-UL	3Ph 60Hz	460V	414	506	6.5x2	4.0x2		1.0+1.0+1.0	29.7 + 22	35 + 25
28	AP336S6FT6P-UL	3Ph 60Hz	460V	414	506	6.5x2	5.4x2		1.0+1.0+1.0+1.0	29.7 + 29.7	35 + 35

Notes MCA :Minimum Circuit Amps
MOCP :Maximum Overcurrent Protection(Amps)

Outdoor unit power supply

4-2-2. MMY-MAP__6FT2P-UL

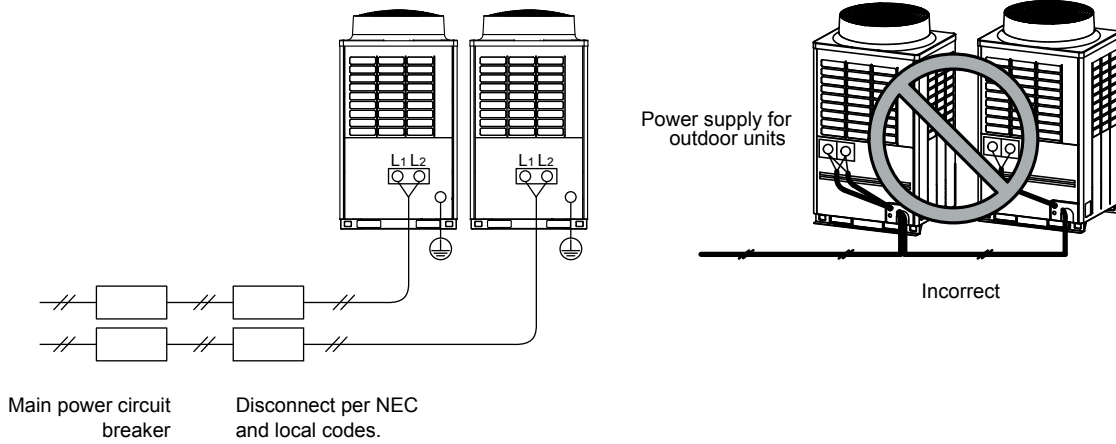

Outdoor unit data

Model name (Standard Model)	Power Supply		Voltage Range		MCA (A)	MOCP (A)
	Nominal Voltage	Phase and frequency	Min. (V)	Max. (V)		
MMY-MAP0726FT2P-UL	208/230 V	1Ph 60 Hz	187	253	47	50
MMY-AP1446FT2P-UL	208/230 V	1Ph 60 Hz	187	253	47 + 47	50 + 50

NOTE : MCA :Minimum Circuit Amps
 MOCP :Maximum Overcurrent Protection(Amps)



4-3. Indoor unit power supply

Type	Model	Nominal voltage(V-Ph-Hz)	Voltage Range(V)		FLA	MCA	MOCP
			Min	Max	A	A	A
4-Way Cassette type	MMU-AP0074HPUL	208/230-1-60	187	253	0.63	0.79	15
	MMU-AP0094HPUL	208/230-1-60	187	253	0.63	0.79	15
	MMU-AP0124HPUL	208/230-1-60	187	253	0.63	0.79	15
	MMU-AP0154HPUL	208/230-1-60	187	253	0.80	1.00	15
	MMU-AP0184HPUL	208/230-1-60	187	253	0.80	1.00	15
	MMU-AP0244HPUL	208/230-1-60	187	253	0.87	1.09	15
	MMU-AP0304HPUL	208/230-1-60	187	253	0.87	1.09	15
	MMU-AP0364HPUL	208/230-1-60	187	253	1.15	1.44	15
	MMU-AP0424HPUL	208/230-1-60	187	253	1.15	1.44	15
Compact 4-Way Cassette type	MMU-AP0484HPUL	208/230-1-60	187	253	1.15	1.44	15
	MMU-AP0544HPUL	208/230-1-60	187	253	1.15	1.44	15
	MMU-AP0071MH-UL	208/230-1-60	187	253	0.4	0.5	15
	MMU-AP0091MH-UL	208/230-1-60	187	253	0.4	0.5	15
	MMU-AP0121MH-UL	208/230-1-60	187	253	0.4	0.5	15
Under Ceiling type	MMU-AP0151MH-UL	208/230-1-60	187	253	0.5	0.7	15
	MMU-AP0181MH-UL	208/230-1-60	187	253	0.5	0.7	15
	MMC-AP0188HPUL	208/230-1-60	187	253	0.4	0.53	15
	MMC-AP0248HPUL	208/230-1-60	187	253	0.75	0.93	15
High Wall type	MMC-AP0308HPUL	208/230-1-60	187	253	0.75	0.93	15
	MMC-AP0368HPUL	208/230-1-60	187	253	0.89	1.11	15
	MMC-AP0488HPUL	208/230-1-60	187	253	0.89	1.11	15
	MMK-AP0077HPUL	208/230-1-60	187	253	0.17	0.21	15
	MMK-AP0097HPUL	208/230-1-60	187	253	0.18	0.23	15
	MMC-AP0127HPUL	208/230-1-60	187	253	0.20	0.25	15
Medium Static Ducted type	MMC-AP0157HPUL	208/230-1-60	187	253	0.30	0.37	15
	MMC-AP0187HPUL	208/230-1-60	187	253	0.33	0.42	15
	MMC-AP0245HPUL	208/230-1-60	187	253	0.48	0.60	15
	MMD-AP0076BHPUL	208/230-1-60	187	253	0.73	0.91	15
	MMD-AP0096BHPUL	208/230-1-60	187	253	0.88	1.10	15
	MMD-AP0126BHPUL	208/230-1-60	187	253	0.88	1.10	15
	MMD-AP0156BHPUL	208/230-1-60	187	253	1.53	1.91	15
	MMD-AP0186BHPUL	208/230-1-60	187	253	1.53	1.91	15
	MMD-AP0216BHPUL	208/230-1-60	187	253	1.78	2.23	15
	MMD-AP0246BHPUL	208/230-1-60	187	253	1.78	2.23	15
High Static Ducted type	MMD-AP0306BHPUL	208/230-1-60	187	253	1.85	2.31	15
	MMD-AP0366BHPUL	208/230-1-60	187	253	2.71	3.39	15
	MMD-AP0426BHPUL	208/230-1-60	187	253	2.71	3.39	15
	MMD-AP0486BHPUL	208/230-1-60	187	253	2.85	3.56	15
	MMD-AP0546BHPUL	208/230-1-60	187	253	2.85	3.56	15
Slim Ducted type	MMD-AP0246HPUL	208/230-1-60	187	253	2.07	2.59	15
	MMD-AP0306HPUL	208/230-1-60	187	253	2.39	2.99	15
	MMD-AP0366HPUL	208/230-1-60	187	253	2.75	3.44	15
	MMD-AP0486HPUL	208/230-1-60	187	253	3.10	3.88	15
	MMD-AP0546HPUL	208/230-1-60	187	253	3.46	4.33	15
Floor Console Exposed type	MMD-AP0074SPH-UL	208/230-1-60	187	253	0.58	0.73	15
	MMD-AP0094SPH-UL	208/230-1-60	187	253	0.58	0.73	15
	MMD-AP0124SPH-UL	208/230-1-60	187	253	0.6	0.75	15
	MMD-AP0154SPH-UL	208/230-1-60	187	253	0.7	0.88	15
Floor Console Concealed type	MMD-AP0184SPH-UL	208/230-1-60	187	253	0.8	1.00	15
	MML-AP0074H2UL	208/230-1-60	187	253	0.5	0.7	15
	MML-AP0094H2UL	208/230-1-60	187	253	0.5	0.7	15
	MML-AP0124H2UL	208/230-1-60	187	253	0.8	1.0	15
	MML-AP0154H2UL	208/230-1-60	187	253	0.8	1.0	15
Floor Console Concealed type	MML-AP0184H2UL	208/230-1-60	187	253	0.9	1.2	15
	MML-AP0244H2UL	208/230-1-60	187	253	0.9	1.2	15
	MML-AP0074BH2UL	208/230-1-60	187	253	0.4	0.5	15
	MML-AP0094BH2UL	208/230-1-60	187	253	0.4	0.5	15
	MML-AP0124BH2UL	208/230-1-60	187	253	0.4	0.5	15
FS unit	MML-AP0154BH2UL	208/230-1-60	187	253	0.8	1.0	15
	MML-AP0184BH2UL	208/230-1-60	187	253	0.8	1.0	15
	MML-AP0244BH2UL	208/230-1-60	187	253	0.8	1.0	15
	RBM-Y0383FUL	208/230-1-60	187	253	0.10	—	—
	RBM-Y0613FUL	208/230-1-60	187	253	0.15	—	—
	RBM-Y0963FUL	208/230-1-60	187	253	0.20	—	—
FS unit	RBM-Y0384FUL	208/230-1-60	187	253	0.10	—	—
	RBM-Y0614FUL	208/230-1-60	187	253	0.15	—	—
	RBM-Y0964FUL	208/230-1-60	187	253	0.20	—	—
	RBM-Y0611F4PUL	208/230-1-60	187	253	0.7	0.7	15
	RBM-Y0611F6PUL	208/230-1-60	187	253	1.0	1.0	15

MCA: Minimum Circuit Amps @208V
MOCP: Maximum Overcurrent Protection (Amps)

FLA: Full Load Amps @208V

Power supply wire

Recommended wire diameter and wire length for power supply wire.

Power supply wiring	Wire side : 2 × AWG12 Ground: 1 × AWG12 or thicker	Up to 164 ft (50 m)
Single port type FS unit 3series	Be sure to use the supplied cable. If the length between the indoor and FS unit exceeds 16 ft (5 m), connect by using the connection cable kit (RBC-CBK15FUL). (Sold separately)	

4-4. Design of control wiring

Summary of communication wiring

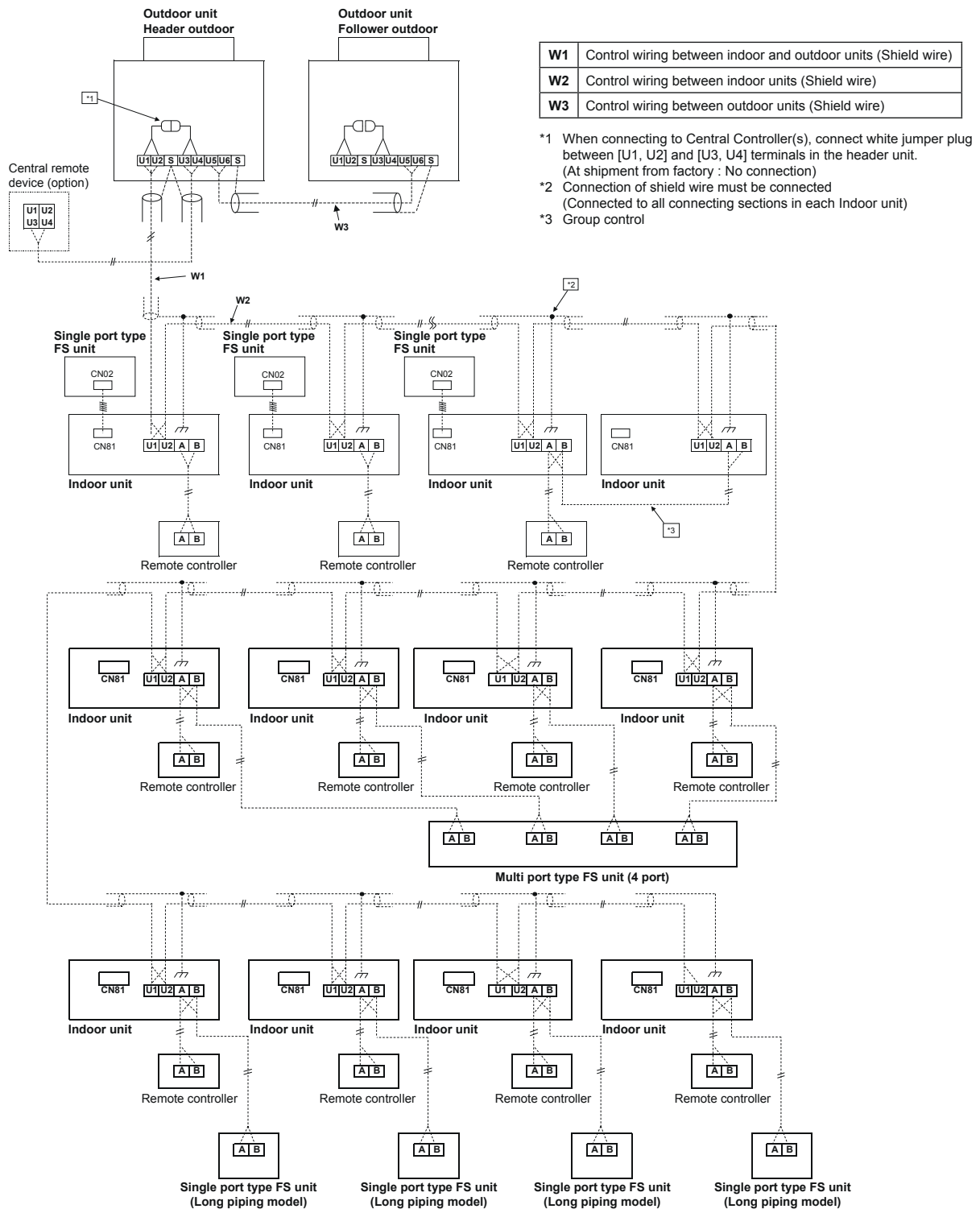

- Communication wiring and control wiring use 2-core non-polarity wires. Use 2-core shield wires to prevent noise trouble.
- Connecting the closed end terminal of shield wire. (Connected to all connecting sections in each unit)
- Use 2-core non-polarity wire for remote controller. (A,B terminals)
- Use 2-core non-polarity wire for Multi port FS unit and Single port long piping type FS unit. (A,B terminals)
- Control wire and power line wire between Single port short FS unit and indoor unit are the accessory parts of FS unit. (Wire length : 20ft) if the length between indoor unit and FS unit exceeds 5m, connect by using the connection cable kit sold separately (RBC-CBK15FE)

Restriction of control wiring

Be sure to keep the rule of below tables about size and length of control wiring.

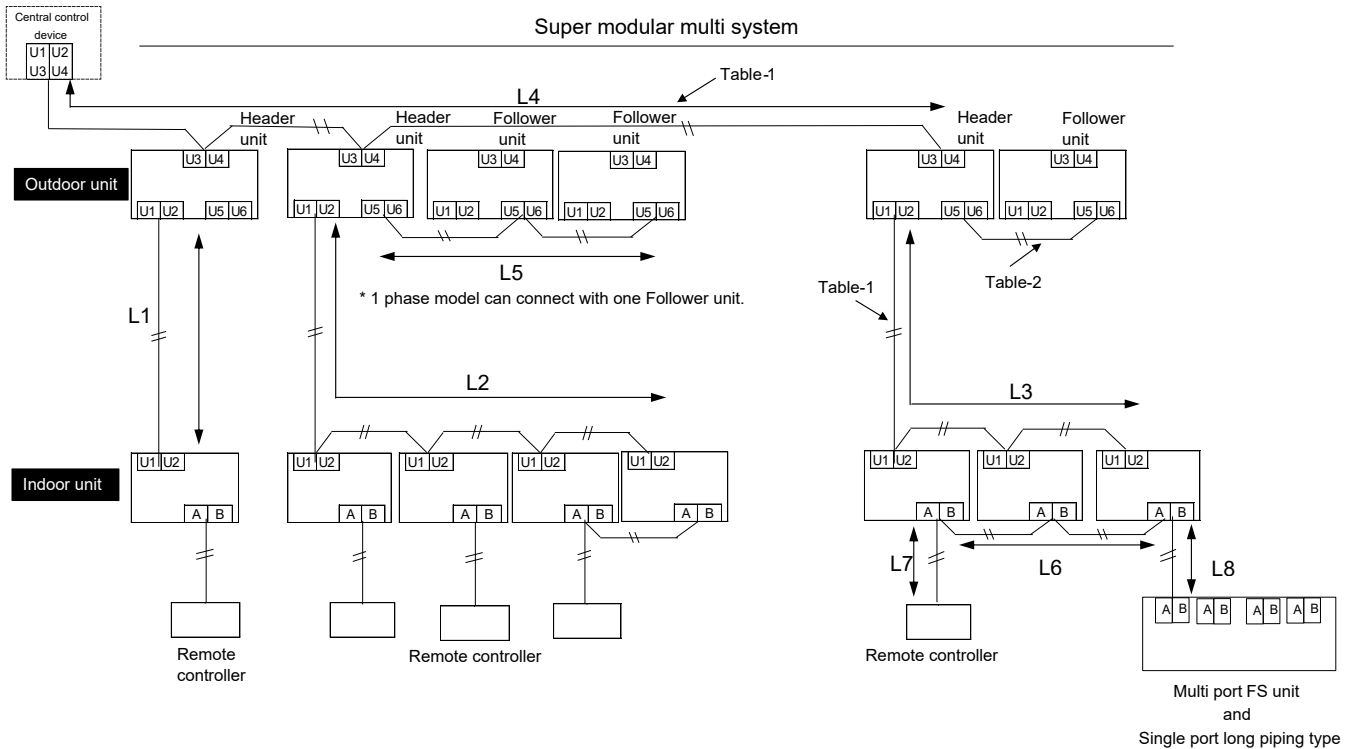

Table- 1 Control wiring between indoor and outdoor units (L1,L2,L3), Central control wiring (L4)

Wiring	2-core
Type	Stranded and Shield wire
Size/Length	AWG16 : Up to 3280 ft (1000 m) AWG14 : Up to 6560 ft (2000) (*1)

Note (*1) Total length of control wiring length for all erfrigerant circuits (L1+L2+L3+L4)

Table- 2 Control wiring between outdoor units (L5)

Wiring	2-core
Type	Stranded and Shield wire
Size/Length	AWG16 to AWG14/Up to 330 ft (100 m)(L5)

Table- 3 Remote control wiring (L6, L7), Multi port type FS unit and Single port long piping type FS unit wiring (L8)

Wire	2-core
Size	0.5mm ² to 2.0mm ²
Length	<ul style="list-style-type: none"> •Up to 1650ft (500m)(L6+L7) •Up to 1320ft(400m) in case of wireless remote controller in group control •Up to 660ft (200m) total length of control wiring between indoor units and Mult port FS unit(L6+L8) •Up to 980ft (300m) (L6+L7+L8) •Up to 980ft (300m) (L7)



5-1 Specifications

System with Non-ducted indoor units

Model name			MMY-MAP0726FT6P-UL	MMY-MAP0966FT6P-UL	MMY-MAP1206FT6P-UL	
Power Supply	Nominal voltage	V/Ph/Hz	460 / 3 / 60	460 / 3 / 60	460 / 3 / 60	
	Voltage range	V	414Minimum / 506 Maximum	414Minimum / 506 Maximum	414Minimum / 506 Maximum	
Cooling	Nominal capacity (*1)	Btu/h	72,000	96,000	120,000	
	Rated capacity (*1)	Btu/h	69,000	92,000	114,000	
	Rated power consumption (*1)(*2)	kW	4.53	7.16	9.39	
	Rated EER (*1)(*2)	(Btu/h)/W	15.2	12.9	12.1	
Heating	Nominal capacity (*1)	Btu/h	81,000	108,000	135,000	
	Rated capacity (*1)	Btu/h	77,000	103,000	129,000	
	Rated power consumption (*1)(*2)	kW	5.98	7.66	10.21	
	Rated COP (*1)(*2)	W/W	3.77	3.94	3.70	
Dimension	Unit	Height	In	72.9	72.9	72.9
		Width	In	39.0	47.6	47.6
		Depth	In	30.7	30.7	30.7
	Packing	Height	In	76.3	76.3	76.3
		Width	In	41.8	50.5	50.5
		Depth	In	32.6	32.6	32.6
Weight	Unit	lbs	615	736	736	
	Packing	lbs	650	776	776	
Color			Silky shade (Munsell 1Y8.5/0.5)	Silky shade (Munsell 1Y8.5/0.5)	Silky shade (Munsell 1Y8.5/0.5)	
Compressor	Type		Hermetic twin rotary compressor	Hermetic twin rotary compressor	Hermetic twin rotary compressor	
	Motor output	kW	2.1 x 2	3.0 x 2	4.0 x 2	
Fan unit	Type		Propeller fan	Propeller fan	Propeller fan	
	Motor output	kW	1.0	1.0	1.0	
	Air volume	cfm	5900	7480	7700	
Maximum external static pressure (*3)	In.WG		0.24	0.16	0.16	
Heat exchanger			Finned tube	Finned tube	Finned tube	
Refrigerant	Name		R410A	R410A	R410A	
	Charged refrigerant amount (*4)	lbs	24.3	24.3	24.3	
High-pressure switch	psi		OFF:420 ON:540	OFF:420 ON:540	OFF:420 ON:540	
Protective devices			(*5)	(*5)	(*5)	
Power supply wiring	MCA	A	11.8	17.0	22.0	
	MOCP (*6)	A	15.0	20.0	25.0	
Piping connections	Liquid	Type	Flare	Flare	Flare	
		Diameter	In	1/2"	1/2"	1/2"
	Suction Gas	Type	Brazing	Brazing	Brazing	
		Diameter	In	7/8"	7/8"	1-1/8"
	Discharge Gas	Type	Flare	Flare	Flare	
		Diameter	In	3/4"	3/4"	3/4"
	Balance	Type	Flare	Flare	Flare	
		Diameter	In	3/8"	3/8"	3/8"
Indoor units	Maximum capacity of combined indoor units		50 to 150%(*7)	50 to 150%(*7)	50 to 150%(*7)	
	Maximum number of indoor units(*8)		12	16	21	
Sound pressure level	Cooling	dB(A)	57.0	62.0	63.0	
	Heating	dB(A)	60.0	62.0	64.0	
Operation temperature range	Cooling	°FDB	14 to 122	14 to 122	14 to 122	
	Heating	°FWB	-13 to 60	-13 to 60	-13 to 60	

Note

(*1) Rated conditions

Cooling : Indoor air temperature 80 F Dry Bulb / 67 F Wet Bulb , Outdoor air temperature 95 F Dry Bulb.

Heating : Indoor air temperature 70 F Dry Bulb, Outdoor air temperature 47 F Dry Bulb / 43 F Wet Bulb.

072, 096 type : Equivalent piping length : 50 ft, Height difference : 0 ft , 120 type : Equivalent piping length : 75 ft, Height difference : 0 ft

(*2) Value for only outdoor unit

(*3) Setting is necessary

(*4) The amount dose not consider extra piping length. Refrigerant must be added on site in accordance with the actual piping length.

(*5) Discharge temp. sensor / Suction temp. sensor / High-pressure sensor / Low-pressure sensor / PC board fuse

(*6) MOCP : Maximum Overcurrent Protection(Amps)

(*7) Permanent operation below 80% is not recommended.

(*8) It is 54 units in case central control is in system.



System with Non-ducted indoor units

Model name			MMY-MAP1446FT6P-UL	MMY-MAP1686FT6P-UL
Power Supply	Nominal voltage	V/Ph/Hz	460 / 3 / 60	460 / 3 / 60
	Voltage range	V	414Minimum / 506 Maximum	414Minimum / 506 Maximum
Cooling	Nominal capacity (*1)	Btu/h	144,000	168,000
	Rated capacity (*1)	Btu/h	138,000	160,000
	Rated power consumption (*1)(*2)	kW	11.03	14.55
	Rated EER (*1)(*2)	(Btu/h)/W	12.5	11.0
Heating	Nominal capacity (*1)	Btu/h	162,000	189,000
	Rated capacity (*1)	Btu/h	154,000	180,000
	Rated power consumption (*1)(*2)	kW	11.76	15.05
	Rated COP (*1)(*2)	W/W	3.84	3.51
Dimension	Unit	Height	In	72.9
		Width	In	63.0
		Depth	In	30.7
	Packing	Height	In	76.3
		Width	In	65.8
		Depth	In	32.6
Weight	Unit	lbs	875	
	Packing	lbs	917	
Color			Silky shade (Munsell 1Y8.5/0.5)	Silky shade (Munsell 1Y8.5/0.5)
Compressor	Type		Hermetic twin rotary compressor	Hermetic twin rotary compressor
	Motor output	kW	5.4 x 2	6.5 x 2
Fan unit	Type		Propeller fan	Propeller fan
	Motor output	kW	1.0+1.0	1.0+1.0
	Air volume	cfm	10850	10850
Maximum external static pressure (*3)		In.WG	0.16	0.16
Heat exchanger			Finned tube	Finned tube
Refrigerant	Name		R410A	R410A
	Charged refrigerant amount (*4)	lbs	24.3	24.3
High-pressure switch		psi	OFF:420 ON:540	OFF:420 ON:540
Protective devices			(*5)	(*5)
Power supply wiring	MCA	A	23.4	29.7
	MOCP (*6)	A	30.0	35.0
Piping connections	Liquid	Type	Flare	Flare
		Diameter	In	5/8"
	Suction Gas	Type	Brazing	Brazing
		Diameter	In	1-1/8"
	Discharge Gas	Type	Flare	Flare
		Diameter	In	7/8"
	Balance	Type	Flare	Flare
		Diameter	In	3/8"
Indoor units	Maximum capacity of combined indoor units		50 to 150%(*7)	50 to 150%(*7)
	Maximum number of indoor units(*8)		25	30
Sound pressure level	Cooling	dB(A)	66.5	66.5
	Heating	dB(A)	66.5	67.0
Operation temperature range	Cooling	°FDB	14 to 122	14 to 122
	Heating	°FWB	-13 to 60	-13 to 60

Note
 (*1) Rated conditions Cooling : Indoor air temperature 80 F Dry Bulb / 67 F Wet Bulb , Outdoor air temperture 95 F Dry Bulb.
 Heating : Indoor air temperature 70 F Dry Bulb, Outdoor air temperture 47 F Dry Bulb / 43 F Wet Bulb.
 Equivalent piping length: 100 ft, Height difference: 0 ft

(*2) Value for only outdoor unit
 (*3) Setting is necessary
 (*4) The amount dose not consider extra piping length. Refrigerant must be added on site in accordance with the actual piping length.
 (*5) Discharge temp. sensor / Suction temp. sensor / High-pressure sensor / Low-pressure sensor / PC board fuse
 (*6) MOCP : Maximum Overcurrent Protection(Amps)
 (*7) Permanent operation below 80% is not recommended.
 (*8) It is 54 units in case central control is in system.



System with Non-ducted indoor units

Model name			MMY-AP1926FT6P-UL	MMY-AP2166FT6P-UL	MMY-AP2406FT6P-UL	MMY-AP2646FT6P-UL
Outdoor unit model name			MMY-MAP0966FT6P-UL	MMY-MAP1206FT6P-UL	MMY-MAP1446FT6P-UL	MMY-MAP1446FT6P-UL
			MMY-MAP0966FT6P-UL	MMY-MAP0966FT6P-UL	MMY-MAP0966FT6P-UL	MMY-MAP1206FT6P-UL
Power Supply	Nominal voltage	V/Ph/Hz	460 / 3 / 60	460 / 3 / 60	460 / 3 / 60	460 / 3 / 60
	Voltage range	V	414Minimum / 506 Maximum	414Minimum / 506 Maximum	414Minimum / 506 Maximum	414Minimum / 506 Maximum
Cooling	Nominal capacity (*1)	Btu/h	192,000	216,000	240,000	264,000
	Rated capacity (*1)	Btu/h	184,000	206,000	230,000	252,000
	Rated power consumption (*1)(*2)	kW	14.60	17.22	19.29	22.44
	Rated EER (*1)(*2)	(Btu/h)/W	12.6	12.0	11.9	11.2
Heating	Nominal capacity (*1)	Btu/h	216,000	243,000	270,000	297,000
	Rated capacity (*1)	Btu/h	206,000	232,000	256,000	282,000
	Rated power consumption (*1)(*2)	kW	15.91	18.63	20.30	23.76
	Rated COP (*1)(*2)	W/W	3.79	3.65	3.70	3.48
Weight	Unit	lbs	736 + 736	736 + 736	875 + 736	875 + 736
	Packing	lbs	776 + 776	776 + 776	917 + 776	917 + 776
Color			Silky shade (Munsell 1Y8.5/0.5)	Silky shade (Munsell 1Y8.5/0.5)	Silky shade (Munsell 1Y8.5/0.5)	Silky shade (Munsell 1Y8.5/0.5)
Compressor	Type		Hermetic twin rotary compressor	Hermetic twin rotary compressor	Hermetic twin rotary compressor	Hermetic twin rotary compressor
	Motor output	kW	3.0 x 2 + 3.0 x 2	4.0 x 2 + 3.0 x 2	5.4 x 2 + 3.0 x 2	5.4 x 2 + 4.0 x 2
Fan unit	Type		Propeller fan	Propeller fan	Propeller fan	Propeller fan
	Motor output	kW	1.0 + 1.0	1.0 + 1.0	1.0+1.0 + 1.0	1.0+1.0 + 1.0
	Air volume	cfm	7480 + 7480	7700 + 7480	10850 + 7480	10850 + 7700
Maximum external static pressure (*3)			In.WG	0.16	0.16	0.16
Heat exchanger			Finned tube	Finned tube	Finned tube	Finned tube
Refrigerant	Name		R410A	R410A	R410A	R410A
	Charged refrigerant amount (*4)	lbs	24.3 + 24.3	24.3 + 24.3	24.3 + 24.3	24.3 + 24.3
High-pressure switch			psi	OFF:420 ON:540	OFF:420 ON:540	OFF:420 ON:540
Protective devices			(*5)	(*5)	(*5)	(*5)
Power supply wiring	MCA	A	17 + 17	22 + 17	23.4 + 17	23.4 + 22
	MOCP (*6)	A	20 + 20	25 + 20	30 + 20	30 + 25
Piping connections	Liquid	Type	Flare	Flare	Flare	Flare
		Diameter	In	3/4"	3/4"	3/4"
	Suction Gas	Type	Brazing	Brazing	Brazing	Brazing
		Diameter	In	1-1/8"	1-3/8"	1-3/8"
	Discharge Gas	Type	Flare	Flare	Flare	Flare
		Diameter	In	7/8"	1-1/8"	1-1/8"
	Balance	Type	Flare	Flare	Flare	Flare
		Diameter	In	3/8"	3/8"	3/8"
Indoor units	Maximum capacity of combined indoor units		50 to 150%(*7)	50 to 150%(*7)	50 to 150%(*7)	50 to 150%(*7)
	Maximum number of indoor units(*8)		34	38	42	46
Sound pressure level	Cooling	dB(A)	65.0	65.5	68.0	68.5
	Heating	dB(A)	65.0	66.5	68.0	68.5
Operation temperature range	Cooling	°FDB	14 to 122	14 to 122	14 to 122	14 to 122
	Heating	°FWB	-13 to 60	-13 to 60	-13 to 60	-13 to 60

Note

- (*1) Rated conditions Cooling : Indoor air temperature 80 F Dry Bulb / 67 F Wet Bulb , Outdoor air tempreture 95 F Dry Bulb.
Heating : Indoor air temperature 70 F Dry Bulb, Outdoor air tempreture 47 F Dry Bulb / 43 F Wet Bulb.
Equivalent piping length: 100 ft, Height difference: 0 ft
- (*2) Value for only outdoor unit
- (*3) Setting is necessary
- (*4) The amount dose not consider extra piping length. Refrigerant must be added on site in accordance with the actual piping length.
- (*5) Discharge temp. sensor / Suction temp. sensor / High-pressure sensor / Low-pressure sensor / PC board fuse
- (*6) MOCP : Maximum Overcurrent Protection(Amps)
- (*7) Permanent operation below 80% is not recommended.
- (*8) It is 54 units in case central control is in system.



System with Non-ducted indoor units

Model name			MMY-AP2886FT6P-UL	MMY-AP3126FT6P-UL
Outdoor unit model name			MMY-MAP1446FT6P-UL	MMY-MAP1686FT6P-UL
			MMY-MAP1446FT6P-UL	MMY-MAP1446FT6P-UL
Power Supply	Nominal voltage	V/Ph/Hz	460 / 3 / 60	460 / 3 / 60
	Voltage range	V	414Minimum / 506 Maximum	414Minimum / 506 Maximum
Cooling	Nominal capacity (*1)	Btu/h	288,000	312,000
	Rated capacity (*1)	Btu/h	276,000	298,000
	Rated power consumption (*1)(*2)	kW	24.14	28.14
	Rated EER (*1)(*2)	(Btu/h)/W	11.43	10.59
Heating	Nominal capacity (*1)	Btu/h	324,000	351,000
	Rated capacity (*1)	Btu/h	308,000	334,000
	Rated power consumption (*1)(*2)	kW	25.50	28.98
	Rated COP (*1)(*2)	W/W	3.54	3.38
Weight	Unit	lbs	875 + 875	875 + 875
	Packing	lbs	917 + 917	917 + 917
Color			Silky shade (Munsell 1Y8.5/0.5)	Silky shade (Munsell 1Y8.5/0.5)
Compressor	Type		Hermetic twin rotary compressor	Hermetic twin rotary compressor
	Motor output	kW	5.4 x 2 + 5.4 x 2	6.5 x 2 + 5.4 x 2
Fan unit	Type		Propeller fan	Propeller fan
	Motor output	kW	1.0+1.0 + 1.0+1.0	1.0+1.0 + 1.0+1.0
	Air volume	cfm	10850 + 10850	10850 + 10850
Maximum external static pressure (*3)			In.WG	0.16
Heat exchanger			Finned tube	Finned tube
Refrigerant	Name		R410A	R410A
	Charged refrigerant amount (*4)	lbs	24.3 + 24.3	24.3 + 24.3
High-pressure switch			psi	OFF:420 ON:540
Protective devices				(*5)
Power supply wiring	MCA	A	23.4 + 23.4	29.7 + 23.4
	MOCP (*6)	A	30 + 30	35 + 30
Piping connections	Liquid	Type	Flare	Flare
		Diameter	In	7/8"
	Suction Gas	Type	Brazing	Brazing
		Diameter	In	1-3/8"
	Discharge Gas	Type	Flare	Flare
		Diameter	In	1-1/8"
	Balance	Type	Flare	Flare
		Diameter	In	3/8"
Indoor units	Maximum capacity of combined indoor units		50 to 150%(*7)	50 to 150%(*7)
	Maximum number of indoor units(*8)		50	55
Sound pressure level	Cooling	dB(A)	69.5	69.5
	Heating	dB(A)	69.5	70.0
Operation temperature range	Cooling	°FDB	14 to 122	14 to 122
	Heating	°FWB	-13 to 60	-13 to 60

Note

(*1) Rated conditions Cooling : Indoor air temperature 80 F Dry Bulb / 67 F Wet Bulb , Outdoor air temperture 95 F Dry Bulb.
 Heating : Indoor air temperature 70 F Dry Bulb, Outdoor air temperture 47 F Dry Bulb / 43 F Wet Bulb.
 Equivalent piping length: 100 ft, Height difference: 0 ft

(*2) Value for only outdoor unit

(*3) Setting is necessary

(*4) The amount dose not consider extra piping length. Refrigerant must be added on site in accordance with the actual piping length.

(*5) Discharge temp. sensor / Suction temp. sensor / High-pressure sensor / Low-pressure sensor / PC board fuse

(*6) MOCP : Maximum Overcurrent Protection(Amps)

(*7) Permanent operation below 80% is not recommended.

(*8) It is 54 units in case central control is in system.

System with Non-ducted indoor units

Model name			MMY-AP3366FT6P-UL	MMY-AP3606FT6P-UL	MMY-AP3846FT6P-UL	MMY-AP4086FT6P-UL
Outdoor unit model name			MMY-MAP1206FT6P-UL	MMY-MAP1206FT6P-UL	MMY-MAP1446FT6P-UL	MMY-MAP1446FT6P-UL
			MMY-MAP1206FT6P-UL	MMY-MAP1206FT6P-UL	MMY-MAP1206FT6P-UL	MMY-MAP1446FT6P-UL
			MMY-MAP0966FT6P-UL	MMY-MAP1206FT6P-UL	MMY-MAP1206FT6P-UL	MMY-MAP1206FT6P-UL
Power Supply	Nominal voltage	V/Ph/Hz	460 / 3 / 60	460 / 3 / 60	460 / 3 / 60	460 / 3 / 60
	Voltage range	V	414Minimum / 506 Maximum	414Minimum / 506 Maximum	414Minimum / 506 Maximum	414Minimum / 506 Maximum
Cooling	Nominal capacity (*1)	Btu/h	336,000	360,000	384,000	408,000
	Rated capacity (*1)	Btu/h	320,000	342,000	366,000	390,000
	Rated power consumption (*1)(*2)	kW	29.11	34.26	36.70	39.49
	Rated EER (*1)(*2)	(Btu/h)/W	11.0	9.98	9.97	9.88
Heating	Nominal capacity (*1)	Btu/h	378,000	405,000	432,000	459,000
	Rated capacity (*1)	Btu/h	360,000	386,000	412,000	436,000
	Rated power consumption (*1)(*2)	kW	30.23	33.48	36.34	38.73
	Rated COP (*1)(*2)	W/W	3.49	3.38	3.32	3.30
Weight	Unit	lbs	736 + 736 + 736	736 + 736 + 736	875 + 736 + 736	875 + 875 + 736
	Packing	lbs	776 + 776 + 776	776 + 776 + 776	917 + 776 + 776	917 + 917 + 776
Color			Silky shade (Munsell 1Y8.5/0.5)	Silky shade (Munsell 1Y8.5/0.5)	Silky shade (Munsell 1Y8.5/0.5)	Silky shade (Munsell 1Y8.5/0.5)
Compressor	Type		Hermetic twin rotary compressor	Hermetic twin rotary compressor	Hermetic twin rotary compressor	Hermetic twin rotary compressor
	Motor output	kW	4.0 x 2 + 4.0 x 2 + 3.0 x 2	4.0 x 2 + 4.0 x 2 + 4.0 x 2	5.4 x 2 + 4.0 x 2 + 4.0 x 2	5.4 x 2 + 5.4 x 2 + 4.0 x 2
Fan unit	Type		Propeller fan	Propeller fan	Propeller fan	Propeller fan
	Motor output	kW	1.0 + 1.0 + 1.0	1.0 + 1.0 + 1.0	1.0+1.0 + 1.0 + 1.0	1.0+1.0 + 1.0+1.0 + 1.0
	Air volume	cfm	7700 + 7700 + 7480	7700 + 7700 + 7700	10850 + 7700 + 7700	10850 + 10850 + 7700
Maximum external static pressure (*3)			In.WG	0.16	0.16	0.16
Heat exchanger			Finned tube	Finned tube	Finned tube	Finned tube
Refrigerant	Name		R410A	R410A	R410A	R410A
	Charged refrigerant amount (*4)	lbs	24.3 + 24.3 + 24.3	24.3 + 24.3 + 24.3	24.3 + 24.3 + 24.3	24.3 + 24.3 + 24.3
High-pressure switch			psi	OFF:420 ON:540	OFF:420 ON:540	OFF:420 ON:540
Protective devices				(*5)	(*5)	(*5)
Power supply wiring	MCA	A	22 + 22 + 17	22 + 22 + 22	23.4 + 22 + 22	23.4 + 23.4 + 22
	MOCP (*6)	A	25 + 25 + 20	25 + 25 + 25	30 + 25 + 25	30 + 30 + 25
Piping connections	Liquid	Type	Flare	Flare	Flare	Flare
		Diameter	In	7/8"	7/8"	7/8"
	Suction Gas	Type	Brazing	Brazing	Brazing	Brazing
		Diameter	In	1-3/8"	1-5/8"	1-5/8"
	Discharge Gas	Type	Flare	Flare	Flare	Flare
		Diameter	In	1-1/8"	1-3/8"	1-3/8"
	Balance	Type	Flare	Flare	Flare	Flare
		Diameter	In	3/8"	3/8"	3/8"
Indoor units	Maximum capacity of combined indoor units		50 to 150%(*7)	50 to 150%(*7)	50 to 150%(*7)	50 to 150%(*7)
	Maximum number of indoor units(*8)		60	63	64	64
Sound pressure level	Cooling	dB(A)	67.5	68.0	69.5	70.5
	Heating	dB(A)	68.5	69.0	70.0	71.0
Operation temperature range	Cooling	°FDB	14 to 122	14 to 122	14 to 122	14 to 122
	Heating	°FWB	-13 to 60	-13 to 60	-13 to 60	-13 to 60

Note

- (*1) Rated conditions Cooling : Indoor air temperature 80 F Dry Bulb / 67 F Wet Bulb , Outdoor air temperature 95 F Dry Bulb.
Heating : Indoor air temperature 70 F Dry Bulb, Outdoor air temperature 47 F Dry Bulb / 43 F Wet Bulb.
336 type : Equivalent piping length: 100 ft, Height difference: 0 ft, 360, 384, 408 type : Equivalent piping length: 150 ft, Height difference: 0 ft
- (*2) Value for only outdoor unit
- (*3) Setting is necessary
- (*4) The amount dose not consider extra piping length. Refrigerant must be added on site in accordance with the actual piping length.
- (*5) Discharge temp. sensor / Suction temp. sensor / High-pressure sensor / Low-pressure sensor / PC board fuse
- (*6) MOCP : Maximum Overcurrent Protection(Amps)
- (*7) Permanent operation below 80% is not recommended.
- (*8) It is 54 units in case central control is in system.



System with Non-ducted indoor units

Model name			MMY-AP4326FT6P-UL	MMY-AP4566FT6P-UL
Outdoor unit model name			MMY-MAP1446FT6P-UL	MMY-MAP1686FT6P-UL
			MMY-MAP1446FT6P-UL	MMY-MAP1446FT6P-UL
			MMY-MAP1446FT6P-UL	MMY-MAP1446FT6P-UL
Power Supply	Nominal voltage	V/Ph/Hz	460 / 3 / 60	460 / 3 / 60
	Voltage range	V	414Minimum / 506 Maximum	414Minimum / 506 Maximum
Cooling	Nominal capacity (*1)	Btu/h	432,000	456,000
	Rated capacity (*1)	Btu/h	412,000	434,000
	Rated power consumption (*1)(*2)	kW	41.28	46.39
	Rated EER (*1)(*2)	(Btu/h)/W	9.98	9.36
Heating	Nominal capacity (*1)	Btu/h	486,000	513,000
	Rated capacity (*1)	Btu/h	462,000	488,000
	Rated power consumption (*1)(*2)	kW	40.99	43.60
	Rated COP (*1)(*2)	W/W	3.30	3.28
Weight	Unit	lbs	875 + 875 + 875	875 + 875 + 875
	Packing	lbs	917 + 917 + 917	917 + 917 + 917
Color			Silky shade (Munsell 1Y8.5/0.5)	Silky shade (Munsell 1Y8.5/0.5)
Compressor	Type		Hermetic twin rotary compressor	Hermetic twin rotary compressor
	Motor output	kW	5.4 x 2 + 5.4 x 2 + 5.4 x 2	6.5 x 2 + 5.4 x 2 + 5.4 x 2
Fan unit	Type		Propeller fan	Propeller fan
	Motor output	kW	1.0+1.0 + 1.0+1.0 + 1.0+1.0	1.0+1.0 + 1.0+1.0 + 1.0+1.0
	Air volume	cfm	10850 + 10850 + 10850	10850 + 10850 + 10850
Maximum external static pressure (*3)			In.WG	0.16
Heat exchanger			Finned tube	Finned tube
Refrigerant	Name		R410A	R410A
	Charged refrigerant amount (*4)	lbs	24.3 + 24.3 + 24.3	24.3 + 24.3 + 24.3
High-pressure switch			psi	OFF:420 ON:540
Protective devices			(*5)	(*5)
Power supply wiring	MCA	A	23.4 + 23.4 + 23.4	29.7 + 23.4 + 23.4
	MOCP (*6)	A	30 + 30 + 30	35 + 30 + 30
Piping connections	Liquid	Type	Flare	Flare
		Diameter	In	7/8"
	Suction Gas	Type	Brazing	Brazing
		Diameter	In	1-5/8"
	Discharge Gas	Type	Flare	Flare
		Diameter	In	1-3/8"
	Balance	Type	Flare	Flare
		Diameter	In	3/8"
Indoor units	Maximum capacity of combined indoor units		50 to 150%(*7)	50 to 150%(*7)
	Maximum number of indoor units(*8)		64	64
Sound pressure level	Cooling	dB(A)	71.5	71.5
	Heating	dB(A)	71.5	71.5
Operation temperature range	Cooling	°FDB	14 to 122	14 to 122
	Heating	°FWB	-13 to 60	-13 to 60

Note

(*1) Rated conditions Cooling : Indoor air temperature 80 F Dry Bulb / 67 F Wet Bulb , Outdoor air temperture 95 F Dry Bulb.
 Heating : Indoor air temperature 70 F Dry Bulb, Outdoor air temperture 47 F Dry Bulb / 43 F Wet Bulb.
 Equivalent piping length: 150 ft, Height difference: 0 ft

(*2) Value for only outdoor unit

(*3) Setting is necessary

(*4) The amount dose not consider extra piping length. Refrigerant must be added on site in accordance with the actual piping length.

(*5) Discharge temp. sensor / Suction temp. sensor / High-pressure sensor / Low-pressure sensor / PC board fuse

(*6) MOCP : Maximum Overcurrent Protection(Amps)

(*7) Permanent operation below 80% is not recommended.

(*8) It is 54 units in case central control is in system.

System with Non-ducted indoor units

Model name			MMY-AP192S6FT6P-UL	MMY-AP240S6FT6P-UL	MMY-AP288S6FT6P-UL	MMY-AP336S6FT6P-UL
Outdoor unit model name			MMY-MAP1206FT6P-UL	MMY-MAP1206FT6P-UL	MMY-MAP1686FT6P-UL	MMY-MAP1686FT6P-UL
			MMY-MAP0726FT6P-UL	MMY-MAP1206FT6P-UL	MMY-MAP1206FT6P-UL	MMY-MAP1686FT6P-UL
Power Supply	Nominal voltage	V/Ph/Hz	460 / 3 / 60	460 / 3 / 60	460 / 3 / 60	460 / 3 / 60
	Voltage range	V	414Minimum / 506 Maximum	414Minimum / 506 Maximum	414Minimum / 506 Maximum	414Minimum / 506 Maximum
Cooling	Nominal capacity (*1)	Btu/h	192,000	240,000	288,000	336,000
	Rated capacity (*1)	Btu/h	184,000	230,000	276,000	320,000
	Rated power consumption (*1)(*2)	kW	15.29	20.91	26.12	30.88
	Rated EER (*1)(*2)	(Btu/h)/W	12.0	11.0	10.6	10.4
Heating	Nominal capacity (*1)	Btu/h	216,000	270,000	324,000	378,000
	Rated capacity (*1)	Btu/h	206,000	256,000	308,000	360,000
	Rated power consumption (*1)(*2)	kW	16.36	20.90	26.28	31.66
	Rated COP (*1)(*2)	W/W	3.69	3.59	3.43	3.33
Weight	Unit	lbs	736 + 615	736 + 736	875 + 736	875 + 875
	Packing	lbs	776 + 650	776 + 776	917 + 776	917 + 917
Color			Silky shade (Munsell 1Y8.5/0.5)	Silky shade (Munsell 1Y8.5/0.5)	Silky shade (Munsell 1Y8.5/0.5)	Silky shade (Munsell 1Y8.5/0.5)
Compressor	Type		Hermetic twin rotary compressor	Hermetic twin rotary compressor	Hermetic twin rotary compressor	Hermetic twin rotary compressor
	Motor output	kW	4.0 x 2 + 2.1 x 2	4.0 x 2 + 4.0 x 2	6.5 x 2 + 4.0 x 2	6.5 x 2 + 6.5 x 2
Fan unit	Type		Propeller fan	Propeller fan	Propeller fan	Propeller fan
	Motor output	kW	1.0 + 1.0	1.0 + 1.0	1.0+1.0 + 1.0	1.0+1.0 + 1.0+1.0
	Air volume	cfm	7700 + 5900	7700 + 7700	10850 + 7700	10850 + 10850
Maximum external static pressure (*3)			In.WG	0.16	0.16	0.16
Heat exchanger			Finned tube	Finned tube	Finned tube	Finned tube
Refrigerant	Name		R410A	R410A	R410A	R410A
	Charged refrigerant amount (*4)	lbs	24.3 + 24.3	24.3 + 24.3	24.3 + 24.3	24.3 + 24.3
High-pressure switch			psi	OFF:420 ON:540	OFF:420 ON:540	OFF:420 ON:540
Protective devices			(*5)	(*5)	(*5)	(*5)
Power supply wiring	MCA	A	22 + 11.8	22 + 22	29.7 + 22	29.7 + 29.7
	MOCP (*6)	A	25 + 15	25 + 25	35 + 25	35 + 35
Piping connections	Liquid	Type	Flare	Flare	Flare	Flare
		Diameter	In	7/8"	7/8"	7/8"
	Suction Gas	Type	Brazing	Brazing	Brazing	Brazing
		Diameter	In	1-1/8"	1-3/8"	1-3/8"
	Discharge Gas	Type	Flare	Flare	Flare	Flare
		Diameter	In	7/8"	1-1/8"	1-1/8"
	Balance	Type	Flare	Flare	Flare	Flare
		Diameter	In	3/8"	3/8"	3/8"
Indoor units	Maximum capacity of combined indoor units		50 to 150%(*7)	50 to 150%(*7)	50 to 150%(*7)	50 to 150%(*7)
	Maximum number of indoor units(*8)		34	42	50	60
Sound pressure level	Cooling	dB(A)	64.0	66.0	68.5	69.5
	Heating	dB(A)	65.5	67.0	69.0	70.0
Operation temperature range	Cooling	°FDB	14 to 122	14 to 122	14 to 122	14 to 122
	Heating	°FWB	-13 to 60	-13 to 60	-13 to 60	-13 to 60

Note

- (*1) Rated conditions Cooling : Indoor air temperature 80 F Dry Bulb / 67 F Wet Bulb , Outdoor air temperture 95 F Dry Bulb.
Heating : Indoor air temperature 70 F Dry Bulb, Outdoor air temperture 47 F Dry Bulb / 43 F Wet Bulb.
Equivalent piping length: 100 ft, Height difference: 0 ft
- (*2) Value for only outdoor unit
- (*3) Setting is necessary
- (*4) The amount dose not consider extra piping length. Refrigerant must be added on site in accordance with the actual piping length.
- (*5) Discharge temp. sensor / Suction temp. sensor / High-pressure sensor / Low-pressure sensor / PC board fuse
- (*6) MOCP : Maximum Overcurrent Protection(Amps)
- (*7) Permanent operation below 80% is not recommended.
- (*8) It is 54 units in case central control is in system.

System with Ducted indoor units

Model name			MMY-MAP0726FT6P-UL	MMY-MAP0966FT6P-UL	MMY-MAP1206FT6P-UL
Power Supply	Nominal voltage	V/Ph/Hz	460 / 3 / 60	460 / 3 / 60	460 / 3 / 60
	Voltage range	V	414Minimum / 506 Maximum	414Minimum / 506 Maximum	414Minimum / 506 Maximum
Cooling	Nominal capacity (*1)	Btu/h	72000	96000	120000
	Rated capacity (*1)	Btu/h	69000	92000	114000
	Rated power consumption (*1)(*2)	kW	5.11	7.34	9.05
	Rated EER (*1)(*2)	(Btu/h)/W	13.5	12.5	12.6
Heating	Nominal capacity (*1)	Btu/h	81000	108000	135000
	Rated capacity (*1)	Btu/h	77000	103000	129000
	Rated power consumption (*1)(*2)	kW	6.25	7.61	10.34
	Rated COP (*1)(*2)	W/W	3.61	3.97	3.66
Dimension	Unit	Height	In	72.9	72.9
		Width	In	39.0	47.6
		Depth	In	30.7	30.7
	Packing	Height	In	76.3	76.3
		Width	In	41.8	50.5
		Depth	In	32.6	32.6
Weight	Unit	lbs	615.0	736.0	736.0
	Packing	lbs	650	776	776
Color			Silky shade (Munsell 1Y8.5/0.5)	Silky shade (Munsell 1Y8.5/0.5)	Silky shade (Munsell 1Y8.5/0.5)
Compressor	Type		Hermetic twin rotary compressor	Hermetic twin rotary compressor	Hermetic twin rotary compressor
	Motor output	kW	2.1 x 2	3.0 x 2	4.0 x 2
Fan unit	Type		Propeller fan	Propeller fan	Propeller fan
	Motor output	kW	1.0	1.0	1.0
	Air volume	cfm	5900	7480	7700
Maximum external static pressure (*3)	In.WG		0.24	0.16	0.16
Heat exchanger			Finned tube	Finned tube	Finned tube
Refrigerant	Name		R410A	R410A	R410A
	Charged refrigerant amount (*4)	lbs	24.3	24.3	24.3
High-pressure switch	psi		OFF:420 ON:540	OFF:420 ON:540	OFF:420 ON:540
Protective devices			(*5)	(*5)	(*5)
Power supply wiring	MCA	A	11.8	17.0	22.0
	MOCP (*6)	A	15.0	20.0	25.0
Piping connections	Liquid	Type	Flare	Flare	Flare
		Diameter	In	1/2"	1/2"
	Suction Gas	Type	Brazing	Brazing	Brazing
		Diameter	In	7/8"	7/8"
	Discharge Gas	Type	Flare	Flare	Flare
		Diameter	In	3/4"	3/4"
	Balance	Type	Flare	Flare	Flare
		Diameter	In	3/8"	3/8"
Indoor units	Maximum capacity of combined indoor units		50 to 150%(*7)	50 to 150%(*7)	50 to 150%(*7)
	Maximum number of indoor units(*8)		12	16	21
Sound pressure level	Cooling	dB(A)	57.0	62.0	63.0
	Heating	dB(A)	60.0	62.0	64.0
Operation temperature range	Cooling	°FDB	14 to 122	14 to 122	14 to 122
	Heating	°FWB	-13 to 60	-13 to 60	-13 to 60

Note

- (*1) Rated conditions Cooling : Indoor air temperature 80 F Dry Bulb / 67 F Wet Bulb , Outdoor air temperature 95 F Dry Bulb.
Heating : Indoor air temperature 70 F Dry Bulb, Outdoor air temperature 47 F Dry Bulb / 43 F Wet Bulb.
Equivalent piping length: 50 ft, Height difference: 0 ft
- (*2) Value for only outdoor unit
- (*3) Setting is necessary
- (*4) The amount does not consider extra piping length. Refrigerant must be added on site in accordance with the actual piping length.
- (*5) Discharge temp. sensor / Suction temp. sensor / High-pressure sensor / Low-pressure sensor / PC board fuse
- (*6) MOCP : Maximum Overcurrent Protection(Amps)
- (*7) Permanent operation below 80% is not recommended.
- (*8) It is 54 units in case central control is in system.



System with Ducted indoor units

Model name			MMY-MAP1446FT6P-UL	MMY-MAP1686FT6P-UL	
Power Supply	Nominal voltage	V/Ph/Hz	460 / 3 / 60	460 / 3 / 60	
	Voltage range	V	414Minimum / 506 Maximum	414Minimum / 506 Maximum	
Cooling	Nominal capacity (*1)	Btu/h	144000	168000	
	Rated capacity (*1)	Btu/h	138000	160000	
	Rated power consumption (*1)(*2)	kW	11.29	14.48	
	Rated EER (*1)(*2)	(Btu/h)/W	12.2	11.1	
Heating	Nominal capacity (*1)	Btu/h	162000	189000	
	Rated capacity (*1)	Btu/h	154000	180000	
	Rated power consumption (*1)(*2)	kW	12.02	15.38	
	Rated COP (*1)(*2)	W/W	3.75	3.43	
Dimension	Unit	Height	In	72.9	72.9
		Width	In	63.0	63.0
		Depth	In	30.7	30.7
	Packing	Height	In	76.3	76.3
		Width	In	65.8	65.8
		Depth	In	32.6	32.6
Weight	Unit	lbs	875.0	875.0	
	Packing	lbs	917	917	
Color			Silky shade (Munsell 1Y8.5/0.5)	Silky shade (Munsell 1Y8.5/0.5)	
Compressor	Type		Hermetic twin rotary compressor	Hermetic twin rotary compressor	
	Motor output	kW	5.4 x 2	6.5 x 2	
Fan unit	Type		Propeller fan	Propeller fan	
	Motor output	kW	1.0+1.0	1.0+1.0	
	Air volume	cfm	10850	10850	
Maximum external static pressure (*3)		In.WG	0.16	0.16	
Heat exchanger			Finned tube	Finned tube	
Refrigerant	Name		R410A	R410A	
	Charged refrigerant amount (*4)	lbs	24.3	24.3	
High-pressure switch		psi	OFF:420 ON:540	OFF:420 ON:540	
Protective devices			(*5)	(*5)	
Power supply wiring	MCA	A	23.4	29.7	
	MOCP (*6)	A	30.0	35.0	
Piping connections	Liquid	Type	Flare	Flare	
		Diameter	In	5/8"	3/4"
	Suction Gas	Type	Brazing	Brazing	
		Diameter	In	1-1/8"	1-1/8"
	Discharge Gas	Type	Flare	Flare	
		Diameter	In	7/8"	7/8"
	Balance	Type	Flare	Flare	
		Diameter	In	3/8"	3/8"
Indoor units	Maximum capacity of combined indoor units		50 to 150%(*7)	50 to 150%(*7)	
	Maximum number of indoor units(*8)		25	30	
Sound pressure level	Cooling	dB(A)	66.5	66.5	
	Heating	dB(A)	66.5	67.0	
Operation temperature range	Cooling	°FDB	14 to 122	14 to 122	
	Heating	°FWB	-13 to 60	-13 to 60	

Note
 (*1) Rated conditions Cooling : Indoor air temperature 80 F Dry Bulb / 67 F Wet Bulb , Outdoor air temperture 95 F Dry Bulb.
 Heating : Indoor air temperature 70 F Dry Bulb, Outdoor air temperture 47 F Dry Bulb / 43 F Wet Bulb.
 Equivalent piping length: 50 ft, Height difference: 0 ft

(*2) Value for only outdoor unit
 (*3) Setting is necessary
 (*4) The amount dose not consider extra piping length. Refrigerant must be added on site in accordance with the actual piping length.
 (*5) Discharge temp. sensor / Suction temp. sensor / High-pressure sensor / Low-pressure sensor / PC board fuse
 (*6) MOCP : Maximum Overcurrent Protection(Amps)
 (*7) Permanent operation below 80% is not recommended.
 (*8) It is 54 units in case central control is in system.

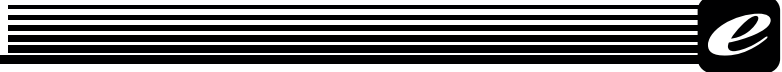

System with Ducted indoor units

Model name			MMY-AP1926FT6P-UL	MMY-AP2166FT6P-UL	MMY-AP2406FT6P-UL	MMY-AP2646FT6P-UL
Outdoor unit model name			MMY-MAP0966FT6P-UL	MMY-MAP1206FT6P-UL	MMY-MAP1446FT6P-UL	MMY-MAP1446FT6P-UL
			MMY-MAP0966FT6P-UL	MMY-MAP0966FT6P-UL	MMY-MAP0966FT6P-UL	MMY-MAP1206FT6P-UL
Power Supply	Nominal voltage	V/Ph/Hz	460 / 3 / 60	460 / 3 / 60	460 / 3 / 60	460 / 3 / 60
	Voltage range	V	414Minimum / 506 Maximum	414Minimum / 506 Maximum	414Minimum / 506 Maximum	414Minimum / 506 Maximum
Cooling	Nominal capacity (*1)	Btu/h	192,000	216,000	240,000	264,000
	Rated capacity (*1)	Btu/h	184,000	206,000	230,000	252,000
	Rated power consumption (*1)(*2)	kW	14.91	17.29	19.26	22.01
	Rated EER (*1)(*2)	(Btu/h)/W	12.34	11.91	11.94	11.45
Heating	Nominal capacity (*1)	Btu/h	216,000	243,000	270,000	297,000
	Rated capacity (*1)	Btu/h	206,000	232,000	256,000	282,000
	Rated power consumption (*1)(*2)	kW	15.36	17.09	19.99	22.80
	Rated COP (*1)(*2)	W/W	3.93	3.98	3.75	3.62
Weight	Unit	lbs	736 + 736	736 + 736	875 + 736	875 + 736
	Packing	lbs	776 + 776	776 + 776	917 + 776	917 + 776
Color			Silky shade (Munsell 1Y8.5/0.5)	Silky shade (Munsell 1Y8.5/0.5)	Silky shade (Munsell 1Y8.5/0.5)	Silky shade (Munsell 1Y8.5/0.5)
Compressor	Type		Hermetic twin rotary compressor	Hermetic twin rotary compressor	Hermetic twin rotary compressor	Hermetic twin rotary compressor
	Motor output	kW	3.0 x 2 + 3.0 x 2	4.0 x 2 + 3.0 x 2	5.4 x 2 + 3.0 x 2	5.4 x 2 + 4.0 x 2
Fan unit	Type		Propeller fan	Propeller fan	Propeller fan	Propeller fan
	Motor output	kW	1.0 + 1.0	1.0 + 1.0	1.0+1.0 + 1.0	1.0+1.0 + 1.0
	Air volume	cfm	7480 + 7480	7700 + 7480	10850 + 7480	10850 + 7700
Maximum external static pressure (*3)			In.WG	0.16	0.16	0.16
Heat exchanger			Finned tube	Finned tube	Finned tube	Finned tube
Refrigerant	Name		R410A	R410A	R410A	R410A
	Charged refrigerant amount (*4)	lbs	24.3 + 24.3	24.3 + 24.3	24.3 + 24.3	24.3 + 24.3
High-pressure switch			psi	OFF:420 ON:540	OFF:420 ON:540	OFF:420 ON:540
Protective devices				(*5)	(*5)	(*5)
Power supply wiring	MCA	A	17 + 17	22 + 17	23.4 + 17	23.4 + 22
	MOCP (*6)	A	20 + 20	25 + 20	30 + 20	30 + 25
Piping connections	Liquid	Type	Flare	Flare	Flare	Flare
		Diameter	In	3/4"	3/4"	3/4"
	Suction Gas	Type	Brazing	Brazing	Brazing	Brazing
		Diameter	In	1-1/8"	1-3/8"	1-3/8"
	Discharge Gas	Type	Flare	Flare	Flare	Flare
		Diameter	In	7/8"	1-1/8"	1-1/8"
	Balance	Type	Flare	Flare	Flare	Flare
		Diameter	In	3/8"	3/8"	3/8"
Indoor units	Maximum capacity of combined indoor units		50 to 150%(*7)	50 to 150%(*7)	50 to 150%(*7)	50 to 150%(*7)
	Maximum number of indoor units(*8)		34	38	42	46
Sound pressure level	Cooling	dB(A)	65.0	65.5	68.0	68.5
	Heating	dB(A)	65.0	66.5	68.0	68.5
Operation temperature range	Cooling	°FDB	14 to 122	14 to 122	14 to 122	14 to 122
	Heating	°FWB	-13 to 60	-13 to 60	-13 to 60	-13 to 60

Note

(*1) Rated conditions
 Cooling : Indoor air temperature 80 F Dry Bulb / 67 F Wet Bulb , Outdoor air temperature 95 F Dry Bulb.
 Heating : Indoor air temperature 70 F Dry Bulb, Outdoor air temperature 47 F Dry Bulb / 43 F Wet Bulb.
 Equivalent piping length: 50 ft, Height difference: 0 ft

(*2) Value for only outdoor unit

(*3) Setting is necessary

(*4) The amount dose not consider extra piping length. Refrigerant must be added on site in accordance with the actual piping length.

(*5) Discharge temp. sensor / Suction temp. sensor / High-pressure sensor / Low-pressure sensor / PC board fuse

(*6) MOCP : Maximum Overcurrent Protection(Amps)

(*7) Permanent operation below 80% is not recommended.

(*8) It is 54 units in case central control is in system.

System with Ducted indoor units

Model name			MMY-AP2886FT6P-UL	MMY-AP3126FT6P-UL
Outdoor unit model name			MMY-MAP1446FT6P-UL	MMY-MAP1686FT6P-UL
			MMY-MAP1446FT6P-UL	MMY-MAP1446FT6P-UL
Power Supply	Nominal voltage	V/Ph/Hz	460 / 3 / 60	460 / 3 / 60
	Voltage range	V	414Minimum / 506 Maximum	414Minimum / 506 Maximum
Cooling	Nominal capacity (*1)	Btu/h	288,000	312,000
	Rated capacity (*1)	Btu/h	276,000	298,000
	Rated power consumption (*1)(*2)	kW	23.96	28.61
	Rated EER (*1)(*2)	(Btu/h)/W	11.5	10.4
Heating	Nominal capacity (*1)	Btu/h	324,000	351,000
	Rated capacity (*1)	Btu/h	308,000	334,000
	Rated power consumption (*1)(*2)	kW	24.97	28.61
	Rated COP (*1)(*2)	W/W	3.62	3.42
Weight	Unit	lbs	875 + 875	875 + 875
	Packing	lbs	917 + 917	917 + 917
Color			Silky shade (Munsell 1Y8.5/0.5)	Silky shade (Munsell 1Y8.5/0.5)
Compressor	Type		Hermetic twin rotary compressor	Hermetic twin rotary compressor
	Motor output	kW	5.4 x 2 + 5.4 x 2	6.5 x 2 + 5.4 x 2
Fan unit	Type		Propeller fan	Propeller fan
	Motor output	kW	1.0+1.0 + 1.0+1.0	1.0+1.0 + 1.0+1.0
	Air volume	cfm	10850 + 10850	10850 + 10850
Maximum external static pressure (*3)			In.WG	0.16
Heat exchanger			Finned tube	Finned tube
Refrigerant	Name		R410A	R410A
	Charged refrigerant amount (*4)	lbs	24.3 + 24.3	24.3 + 24.3
High-pressure switch			psi	OFF:420 ON:540
Protective devices				(*5)
Power supply wiring	MCA	A	23.4 + 23.4	29.7 + 23.4
	MOCP (*6)	A	30 + 30	35 + 30
Piping connections	Liquid	Type	Flare	Flare
		Diameter	In	7/8"
	Suction Gas	Type	Brazing	Brazing
		Diameter	In	1-3/8"
	Discharge Gas	Type	Flare	Flare
		Diameter	In	1-1/8"
	Balance	Type	Flare	Flare
		Diameter	In	3/8"
Indoor units	Maximum capacity of combined indoor units		50 to 150%(*7)	50 to 150%(*7)
	Maximum number of indoor units(*8)		50	55
Sound pressure level	Cooling	dB(A)	69.5	69.5
	Heating	dB(A)	69.5	70.0
Operation temperature range	Cooling	°FDB	14 to 122	14 to 122
	Heating	°FWB	-13 to 60	-13 to 60

Note

(*1) Rated conditions Cooling : Indoor air temperature 80 F Dry Bulb / 67 F Wet Bulb , Outdoor air temperture 95 F Dry Bulb.
 Heating : Indoor air temperature 70 F Dry Bulb, Outdoor air temperture 47 F Dry Bulb / 43 F Wet Bulb.
 Equivalent piping length: 50 ft, Height difference: 0 ft

(*2) Value for only outdoor unit

(*3) Setting is necessary

(*4) The amount dose not consider extra piping length. Refrigerant must be added on site in accordance with the actual piping length.

(*5) Discharge temp. sensor / Suction temp. sensor / High-pressure sensor / Low-pressure sensor / PC board fuse

(*6) MOCP : Maximum Overcurrent Protection(Amps)

(*7) Permanent operation below 80% is not recommended.

(*8) It is 54 units in case central control is in system.

System with Ducted indoor units

Model name			MMY-AP3366FT6P-UL	MMY-AP3606FT6P-UL	MMY-AP3846FT6P-UL	MMY-AP4086FT6P-UL
Outdoor unit model name			MMY-MAP1206FT6P-UL	MMY-MAP1206FT6P-UL	MMY-MAP1446FT6P-UL	MMY-MAP1446FT6P-UL
			MMY-MAP1206FT6P-UL	MMY-MAP1206FT6P-UL	MMY-MAP1206FT6P-UL	MMY-MAP1446FT6P-UL
			MMY-MAP0966FT6P-UL	MMY-MAP1206FT6P-UL	MMY-MAP1206FT6P-UL	MMY-MAP1206FT6P-UL
Power Supply	Nominal voltage	V/Ph/Hz	460 / 3 / 60	460 / 3 / 60	460 / 3 / 60	460 / 3 / 60
	Voltage range	V	414Minimum / 506 Maximum	414Minimum / 506 Maximum	414Minimum / 506 Maximum	414Minimum / 506 Maximum
Cooling	Nominal capacity (*1)	Btu/h	336,000	360,000	384,000	408,000
	Rated capacity (*1)	Btu/h	320,000	342,000	366,000	390,000
	Rated power consumption (*1)(*2)	kW	30.20	34.72	37.21	39.70
	Rated EER (*1)(*2)	(Btu/h)/W	10.6	9.85	9.84	9.82
Heating	Nominal capacity (*1)	Btu/h	378,000	405,000	432,000	459,000
	Rated capacity (*1)	Btu/h	360,000	386,000	412,000	436,000
	Rated power consumption (*1)(*2)	kW	30.63	32.39	35.72	37.84
	Rated COP (*1)(*2)	W/W	3.44	3.49	3.38	3.38
Weight	Unit	lbs	736 + 736 + 736	736 + 736 + 736	875 + 736 + 736	875 + 875 + 736
	Packing	lbs	776 + 776 + 776	776 + 776 + 776	917 + 776 + 776	917 + 917 + 776
Color			Silky shade (Munsell 1Y8.5/0.5)	Silky shade (Munsell 1Y8.5/0.5)	Silky shade (Munsell 1Y8.5/0.5)	Silky shade (Munsell 1Y8.5/0.5)
Compressor	Type		Hermetic twin rotary compressor	Hermetic twin rotary compressor	Hermetic twin rotary compressor	Hermetic twin rotary compressor
	Motor output	kW	4.0 x 2 + 4.0 x 2 + 3.0 x 2	4.0 x 2 + 4.0 x 2 + 4.0 x 2	5.4 x 2 + 4.0 x 2 + 4.0 x 2	5.4 x 2 + 5.4 x 2 + 4.0 x 2
Fan unit	Type		Propeller fan	Propeller fan	Propeller fan	Propeller fan
	Motor output	kW	1.0 + 1.0 + 1.0	1.0 + 1.0 + 1.0	1.0+1.0 + 1.0 + 1.0	1.0+1.0 + 1.0+1.0 + 1.0
	Air volume	cfm	7700 + 7700 + 7480	7700 + 7700 + 7700	10850 + 7700 + 7700	10850 + 10850 + 7700
Maximum external static pressure (*3)			In.WG	0.16	0.16	0.16
Heat exchanger			Finned tube	Finned tube	Finned tube	Finned tube
Refrigerant	Name		R410A	R410A	R410A	R410A
	Charged refrigerant amount (*4)	lbs	24.3 + 24.3 + 24.3	24.3 + 24.3 + 24.3	24.3 + 24.3 + 24.3	24.3 + 24.3 + 24.3
High-pressure switch			psi	OFF:420 ON:540	OFF:420 ON:540	OFF:420 ON:540
Protective devices				(*5)	(*5)	(*5)
Power supply wiring	MCA	A	22 + 22 + 17	22 + 22 + 22	23.4 + 22 + 22	23.4 + 23.4 + 22
	MOCP (*6)	A	25 + 25 + 20	25 + 25 + 25	30 + 25 + 25	30 + 30 + 25
Piping connections	Liquid	Type	Flare	Flare	Flare	Flare
		Diameter	In	7/8"	7/8"	7/8"
	Suction Gas	Type	Brazing	Brazing	Brazing	Brazing
		Diameter	In	1-3/8"	1-5/8"	1-5/8"
	Discharge Gas	Type	Flare	Flare	Flare	Flare
		Diameter	In	1-1/8"	1-3/8"	1-3/8"
	Balance	Type	Flare	Flare	Flare	Flare
		Diameter	In	3/8"	3/8"	3/8"
Indoor units	Maximum capacity of combined indoor units		50 to 150%(*7)	50 to 150%(*7)	50 to 150%(*7)	50 to 150%(*7)
	Maximum number of indoor units(*8)		60	63	64	64
Sound pressure level	Cooling	dB(A)	67.5	68.0	69.5	70.5
	Heating	dB(A)	68.5	69.0	70.0	71.0
Operation temperature range	Cooling	*FDB	14 to 122	14 to 122	14 to 122	14 to 122
	Heating	*FWB	-13 to 60	-13 to 60	-13 to 60	-13 to 60

Note

- (*1) Rated conditions Cooling : Indoor air temperature 80 F Dry Bulb / 67 F Wet Bulb , Outdoor air temperture 95 F Dry Bulb.
Heating : Indoor air temperature 70 F Dry Bulb, Outdoor air temperture 47 F Dry Bulb / 43 F Wet Bulb.
336 type: Equivalent piping length: 50 ft, Height difference: 0 ft, 360, 384, 408 type : Equivalent piping length: 75 ft, Height difference: 0 ft,
- (*2) Value for only outdoor unit
- (*3) Setting is necessary
- (*4) The amount dose not consider extra piping length. Refrigerant must be added on site in accordance with the actual piping length.
- (*5) Discharge temp. sensor / Suction temp. sensor / High-pressure sensor / Low-pressure sensor / PC board fuse
- (*6) MOCP : Maximum Overcurrent Protection(Amps)
- (*7) Permanent operation below 80% is not recommended.
- (*8) It is 54 units in case central control is in system.

System with Ducted indoor units

Model name			MMY-AP4326FT6P-UL	MMY-AP4566FT6P-UL
Outdoor unit model name			MMY-MAP1446FT6P-UL	MMY-MAP1686FT6P-UL
			MMY-MAP1446FT6P-UL	MMY-MAP1446FT6P-UL
			MMY-MAP1446FT6P-UL	MMY-MAP1446FT6P-UL
Power Supply	Nominal voltage	V/Ph/Hz	460 / 3 / 60	460 / 3 / 60
	Voltage range	V	414Minimum / 506 Maximum	414Minimum / 506 Maximum
Cooling	Nominal capacity (*1)	Btu/h	432,000	456,000
	Rated capacity (*1)	Btu/h	412,000	434,000
	Rated power consumption (*1)(*2)	kW	42.09	45.32
	Rated EER (*1)(*2)	(Btu/h)/W	9.79	9.58
Heating	Nominal capacity (*1)	Btu/h	486,000	513,000
	Rated capacity (*1)	Btu/h	462,000	488,000
	Rated power consumption (*1)(*2)	kW	41.05	43.36
	Rated COP (*1)(*2)	W/W	3.30	3.30
Weight	Unit	lbs	875 + 875 + 875	875 + 875 + 875
	Packing	lbs	917 + 917 + 917	917 + 917 + 917
Color			Silky shade (Munsell 1Y8.5/0.5)	Silky shade (Munsell 1Y8.5/0.5)
Compressor	Type		Hermetic twin rotary compressor	Hermetic twin rotary compressor
	Motor output	kW	5.4 x 2 + 5.4 x 2 + 5.4 x 2	6.5 x 2 + 5.4 x 2 + 5.4 x 2
Fan unit	Type		Propeller fan	Propeller fan
	Motor output	kW	1.0+1.0 + 1.0+1.0 + 1.0+1.0	1.0+1.0 + 1.0+1.0 + 1.0+1.0
	Air volume	cfm	10850 + 10850 + 10850	10850 + 10850 + 10850
Maximum external static pressure (*3)			In.WG	0.16
Heat exchanger			Finned tube	Finned tube
Refrigerant	Name		R410A	R410A
	Charged refrigerant amount (*4)	lbs	24.3 + 24.3 + 24.3	24.3 + 24.3 + 24.3
High-pressure switch			psi	OFF:420 ON:540
Protective devices				(*5)
Power supply wiring	MCA	A	23.4 + 23.4 + 23.4	29.7 + 23.4 + 23.4
	MOCP (*6)	A	30 + 30 + 30	35 + 30 + 30
Piping connections	Liquid	Type	Flare	Flare
		Diameter	In	7/8"
	Suction Gas	Type	Brazing	Brazing
		Diameter	In	1-5/8"
	Discharge Gas	Type	Flare	Flare
		Diameter	In	1-3/8"
	Balance	Type	Flare	Flare
		Diameter	In	3/8"
Indoor units	Maximum capacity of combined indoor units		50 to 150%(*7)	50 to 150%(*7)
	Maximum number of indoor units(*8)		64	64
Sound pressure level	Cooling	dB(A)	71.5	71.5
	Heating	dB(A)	71.5	71.5
Operation temperature range	Cooling	°FDB	14 to 122	14 to 122
	Heating	°FWB	-13 to 60	-13 to 60

Note

(*1) Rated conditions Cooling : Indoor air temperature 80 F Dry Bulb / 67 F Wet Bulb , Outdoor air temperature 95 F Dry Bulb.
 Heating : Indoor air temperature 70 F Dry Bulb, Outdoor air temperature 47 F Dry Bulb / 43 F Wet Bulb.
 Equivalent piping length: 75 ft, Height difference: 0 ft

(*2) Value for only outdoor unit

(*3) Setting is necessary

(*4) The amount does not consider extra piping length. Refrigerant must be added on site in accordance with the actual piping length.

(*5) Discharge temp. sensor / Suction temp. sensor / High-pressure sensor / Low-pressure sensor / PC board fuse

(*6) MOCP : Maximum Overcurrent Protection(Amps)

(*7) Permanent operation below 80% is not recommended.

(*8) It is 54 units in case central control is in system.

System with Non-ducted indoor units

Model name			MMY-AP192S6FT6P-UL	MMY-AP240S6FT6P-UL	MMY-AP288S6FT6P-UL	MMY-AP336S6FT6P-UL
Outdoor unit model name			MMY-MAP1206FT6P-UL	MMY-MAP1206FT6P-UL	MMY-MAP1686FT6P-UL	MMY-MAP1686FT6P-UL
			MMY-MAP0726FT6P-UL	MMY-MAP1206FT6P-UL	MMY-MAP1206FT6P-UL	MMY-MAP1686FT6P-UL
Power Supply	Nominal voltage	V/Ph/Hz	460 / 3 / 60	460 / 3 / 60	460 / 3 / 60	460 / 3 / 60
	Voltage range	V	414Minimum / 506 Maximum	414Minimum / 506 Maximum	414Minimum / 506 Maximum	414Minimum / 506 Maximum
Cooling	Nominal capacity (*1)	Btu/h	192,000	240,000	288,000	336,000
	Rated capacity (*1)	Btu/h	184,000	230,000	276,000	320,000
	Rated power consumption (*1)(*2)	kW	15.19	20.81	26.99	32.44
	Rated EER (*1)(*2)	(Btu/h)/W	12.1	11.1	10.2	9.86
Heating	Nominal capacity (*1)	Btu/h	216,000	270,000	324,000	378,000
	Rated capacity (*1)	Btu/h	206,000	256,000	308,000	360,000
	Rated power consumption (*1)(*2)	kW	15.82	20.60	25.67	31.82
	Rated COP (*1)(*2)	W/W	3.82	3.64	3.52	3.32
Weight	Unit	lbs	736 + 615	736 + 736	875 + 736	875 + 875
	Packing	lbs	776 + 650	776 + 776	917 + 776	917 + 917
Color			Silky shade (Munsell 1Y8.5/0.5)	Silky shade (Munsell 1Y8.5/0.5)	Silky shade (Munsell 1Y8.5/0.5)	Silky shade (Munsell 1Y8.5/0.5)
Compressor	Type		Hermetic twin rotary compressor	Hermetic twin rotary compressor	Hermetic twin rotary compressor	Hermetic twin rotary compressor
	Motor output	kW	4.0 x 2 + 2.1 x 2	4.0 x 2 + 4.0 x 2	6.5 x 2 + 4.0 x 2	6.5 x 2 + 6.5 x 2
Fan unit	Type		Propeller fan	Propeller fan	Propeller fan	Propeller fan
	Motor output	kW	1.0 + 1.0	1.0 + 1.0	1.0+1.0 + 1.0	1.0+1.0 + 1.0+1.0
	Air volume	cfm	7700 + 5900	7700 + 7700	10850 + 7700	10850 + 10850
Maximum external static pressure (*3)			In.WG	0.16	0.16	0.16
Heat exchanger			Finned tube	Finned tube	Finned tube	Finned tube
Refrigerant	Name		R410A	R410A	R410A	R410A
	Charged refrigerant amount (*4)	lbs	24.3 + 24.3	24.3 + 24.3	24.3 + 24.3	24.3 + 24.3
High-pressure switch			psi	OFF:420 ON:540	OFF:420 ON:540	OFF:420 ON:540
Protective devices			(*5)	(*5)	(*5)	(*5)
Power supply wiring	MCA	A	22 + 11.8	22 + 22	29.7 + 22	29.7 + 29.7
	MOCP (*6)	A	25 + 15	25 + 25	35 + 25	35 + 35
Piping connections	Liquid	Type	Flare	Flare	Flare	Flare
		Diameter	In	7/8"	7/8"	7/8"
	Suction Gas	Type	Brazing	Brazing	Brazing	Brazing
		Diameter	In	1-1/8"	1-3/8"	1-3/8"
	Discharge Gas	Type	Flare	Flare	Flare	Flare
		Diameter	In	7/8"	1-1/8"	1-1/8"
	Balance	Type	Flare	Flare	Flare	Flare
		Diameter	In	3/8"	3/8"	3/8"
Indoor units	Maximum capacity of combined indoor units		50 to 150%(*7)	50 to 150%(*7)	50 to 150%(*7)	50 to 150%(*7)
	Maximum number of indoor units(*8)		34	42	50	60
Sound pressure level	Cooling	dB(A)	64.0	66.0	68.5	69.5
	Heating	dB(A)	65.5	67.0	69.0	70.0
Operation temperature range	Cooling	°FDB	14 to 122	14 to 122	14 to 122	14 to 122
	Heating	°FWB	-13 to 60	-13 to 60	-13 to 60	-13 to 60

Note

- (*1) Rated conditions Cooling : Indoor air temperature 80 F Dry Bulb / 67 F Wet Bulb , Outdoor air tempreture 95 F Dry Bulb.
Heating : Indoor air temperature 70 F Dry Bulb, Outdoor air tempreture 47 F Dry Bulb / 43 F Wet Bulb.
Equivalent piping length: 50 ft, Height difference: 0 ft
- (*2) Value for only outdoor unit
- (*3) Setting is necessary
- (*4) The amount dose not consider extra piping length. Refrigerant must be added on site in accordance with the actual piping length.
- (*5) Discharge temp. sensor / Suction temp. sensor / High-pressure sensor / Low-pressure sensor / PC board fuse
- (*6) MOCP : Maximum Overcurrent Protection(Amps)
- (*7) Permanent operation below 80% is not recommended.
- (*8) It is 54 units in case central control is in system.



System with Non-ducted indoor units

Model name			MMY-MAP0726FT9P-UL	MMY-MAP0966FT9P-UL	MMY-MAP1206FT9P-UL
Power Supply	Nominal voltage	V/Ph/Hz	208-230 / 3 / 60	208-230 / 3 / 60	208-230 / 3 / 60
	Voltage range	V	187Minimum / 253 Maximum	187Minimum / 253 Maximum	187Minimum / 253 Maximum
Cooling	Nominal capacity (*1)	Btu/h	72,000	96,000	120,000
	Rated capacity (*1)	Btu/h	69,000	92,000	114,000
	Rated power consumption (*1)(*2)	kW	4.53	7.16	9.39
	Rated EER (*1)(*2)	(Btu/h)/W	15.2	12.9	12.1
Heating	Nominal capacity (*1)	Btu/h	81,000	108,000	135,000
	Rated capacity (*1)	Btu/h	77,000	103,000	129,000
	Rated power consumption (*1)(*2)	kW	5.98	7.66	10.21
	Rated COP (*1)(*2)	W/W	3.77	3.94	3.70
Dimension	Unit	Height	In	72.9	72.9
		Width	In	39.0	47.6
		Depth	In	30.7	30.7
	Packing	Height	In	76.3	76.3
		Width	In	41.8	50.5
		Depth	In	32.6	32.6
Weight	Unit	lbs	600	721	721
	Packing	lbs	635	761	761
Color			Silky shade (Munsell 1Y8.5/0.5)	Silky shade (Munsell 1Y8.5/0.5)	Silky shade (Munsell 1Y8.5/0.5)
Compressor	Type		Hermetic twin rotary compressor	Hermetic twin rotary compressor	Hermetic twin rotary compressor
	Motor output	kW	2.1 x 2	3.0 x 2	4.0 x 2
Fan unit	Type		Propeller fan	Propeller fan	Propeller fan
	Motor output	kW	1.0	1.0	1.0
	Air volume	cfm	5900	7480	7700
Maximum external static pressure (*3)		In.WG	0.24	0.16	0.16
Heat exchanger			Finned tube	Finned tube	Finned tube
Refrigerant	Name		R410A	R410A	R410A
	Charged refrigerant amount (*4)	lbs	24.3	24.3	24.3
High-pressure switch		psi	OFF:420 ON:540	OFF:420 ON:540	OFF:420 ON:540
Protective devices			(*5)	(*5)	(*5)
Power supply wiring	MCA	A	23.3	34.2	45.4
	MOCP (*6)	A	30.0	40.0	50.0
Piping connections	Liquid	Type	Flare	Flare	Flare
		Diameter	In	1/2"	1/2"
	Suction Gas	Type	Brazing	Brazing	Brazing
		Diameter	In	7/8"	7/8"
	Discharge Gas	Type	Flare	Flare	Flare
		Diameter	In	3/4"	3/4"
	Balance	Type	Flare	Flare	Flare
		Diameter	In	3/8"	3/8"
Indoor units	Maximum capacity of combined indoor units		50 to 150%(*7)	50 to 150%(*7)	50 to 150%(*7)
	Maximum number of indoor units(*8)		12	16	21
Sound pressure level	Cooling	dB(A)	57.0	62.0	63.0
	Heating	dB(A)	60.0	62.0	64.0
Operation temperature range	Cooling	°FDB	14 to 122	14 to 122	14 to 122
	Heating	°FWB	-13 to 60	-13 to 60	-13 to 60

Note

- (*1) Rated conditions Cooling : Indoor air temperature 80 F Dry Bulb / 67 F Wet Bulb , Outdoor air temperture 95 F Dry Bulb.
Heating : Indoor air temperature 70 F Dry Bulb, Outdoor air temperture 47 F Dry Bulb / 43 F Wet Bulb.
072, 096 type : Equivalent piping length : 50 ft, Height difference : 0 ft , 120 type : Equivalent piping length : 75 ft, Height difference : 0 ft
- (*2) Value for only outdoor unit
- (*3) Setting is necessary
- (*4) The amount dose not consider extra piping length. Refrigerant must be added on site in accordance with the actual piping length.
- (*5) Discharge temp. sensor / Suction temp. sensor / High-pressure sensor / Low-pressure sensor / PC board fuse
- (*6) MOCP : Maximum Overcurrent Protection(Amps)
- (*7) Permanent operation below 80% is not recommended.
- (*8) It is 54 units in case central control is in system.



System with Non-ducted indoor units

Model name			MMY-MAP1446FT9P-UL	MMY-MAP1686FT9P-UL	
Power Supply	Nominal voltage	V/Ph/Hz	208-230 / 3 / 60	208-230 / 3 / 60	
	Voltage range	V	187Minimum / 253 Maximum	187Minimum / 253 Maximum	
Cooling	Nominal capacity (*1)	Btu/h	144,000	168,000	
	Rated capacity (*1)	Btu/h	138,000	160,000	
	Rated power consumption (*1)(*2)	kW	11.03	14.55	
	Rated EER (*1)(*2)	(Btu/h)/W	12.5	11.0	
Heating	Nominal capacity (*1)	Btu/h	162,000	189,000	
	Rated capacity (*1)	Btu/h	154,000	180,000	
	Rated power consumption (*1)(*2)	kW	11.76	15.05	
	Rated COP (*1)(*2)	W/W	3.84	3.51	
Dimension	Unit	Height	In	72.9	72.9
		Width	In	63.0	63.0
		Depth	In	30.7	30.7
	Packing	Height	In	76.3	76.3
		Width	In	65.8	65.8
		Depth	In	32.6	32.6
Weight	Unit	lbs	882	882	
	Packing	lbs	924	924	
Color			Silky shade (Munsell 1Y8.5/0.5)	Silky shade (Munsell 1Y8.5/0.5)	
Compressor	Type		Hermetic twin rotary compressor	Hermetic twin rotary compressor	
	Motor output	kW	5.4 x 2	6.5 x 2	
Fan unit	Type		Propeller fan	Propeller fan	
	Motor output	kW	1.0+1.0	1.0+1.0	
	Air volume	cfm	10850	10850	
Maximum external static pressure (*3)	In.WG		0.16	0.16	
Heat exchanger			Finned tube	Finned tube	
Refrigerant	Name		R410A	R410A	
	Charged refrigerant amount (*4)	lbs	24.3	24.3	
High-pressure switch	psi		OFF:420 ON:540	OFF:420 ON:540	
Protective devices			(*5)	(*5)	
Power supply wiring	MCA	A	52.1	66.2	
	MOCP (*6)	A	60.0	70.0	
Piping connections	Liquid	Type	Flare	Flare	
		Diameter	In	5/8"	3/4"
	Suction Gas	Type	Brazing	Brazing	
		Diameter	In	1-1/8"	1-1/8"
	Discharge Gas	Type	Flare	Flare	
		Diameter	In	7/8"	7/8"
	Balance	Type	Flare	Flare	
		Diameter	In	3/8"	3/8"
Indoor units	Maximum capacity of combined indoor units		50 to 150%(*7)	50 to 150%(*7)	
	Maximum number of indoor units(*8)		25	30	
Sound pressure level	Cooling	dB(A)	66.5	66.5	
	Heating	dB(A)	66.5	67.0	
Operation temperature range	Cooling	°FDB	14 to 122	14 to 122	
	Heating	°FWB	-13 to 60	-13 to 60	

Note

- (*1) Rated conditions Cooling : Indoor air temperature 80 F Dry Bulb / 67 F Wet Bulb , Outdoor air temperature 95 F Dry Bulb.
Heating : Indoor air temperature 70 F Dry Bulb, Outdoor air temperature 47 F Dry Bulb / 43 F Wet Bulb.
Equivalent piping length: 100 ft, Height difference: 0 ft
- (*2) Value for only outdoor unit
- (*3) Setting is necessary
- (*4) The amount dose not consider extra piping length. Refrigerant must be added on site in accordance with the actual piping length.
- (*5) Discharge temp. sensor / Suction temp. sensor / High-pressure sensor / Low-pressure sensor / PC board fuse
- (*6) MOCP : Maximum Overcurrent Protection(Amps)
- (*7) Permanent operation below 80% is not recommended.
- (*8) It is 54 units in case central control is in system.

System with Non-ducted indoor units

Model name			MMY-AP1926FT9P-UL	MMY-AP2166FT9P-UL	MMY-AP2406FT9P-UL	MMY-AP2646FT9P-UL
Outdoor unit model name			MMY-MAP0966FT9P-UL	MMY-MAP1206FT9P-UL	MMY-MAP1446FT9P-UL	MMY-MAP1446FT9P-UL
			MMY-MAP0966FT9P-UL	MMY-MAP0966FT9P-UL	MMY-MAP0966FT9P-UL	MMY-MAP1206FT9P-UL
Power Supply	Nominal voltage	V/Ph/Hz	208-230 / 3 / 60	208-230 / 3 / 60	208-230 / 3 / 60	208-230 / 3 / 60
	Voltage range	V	187Minimum / 253 Maximum	187Minimum / 253 Maximum	187Minimum / 253 Maximum	187Minimum / 253 Maximum
Cooling	Nominal capacity (*1)	Btu/h	192,000	216,000	240,000	264,000
	Rated capacity (*1)	Btu/h	184,000	206,000	230,000	252,000
	Rated power consumption (*1)(*2)	kW	14.60	17.22	19.29	22.44
	Rated EER (*1)(*2)	(Btu/h)/W	12.6	12.0	11.9	11.2
Heating	Nominal capacity (*1)	Btu/h	216,000	243,000	270,000	297,000
	Rated capacity (*1)	Btu/h	206,000	232,000	256,000	282,000
	Rated power consumption (*1)(*2)	kW	15.91	18.63	20.30	23.76
	Rated COP (*1)(*2)	W/W	3.79	3.65	3.70	3.48
Weight	Unit	lbs	721 + 721	721 + 721	882 + 721	882 + 721
	Packing	lbs	761 + 761	761 + 761	924 + 761	924 + 761
Color			Silky shade (Munsell 1Y8.5/0.5)	Silky shade (Munsell 1Y8.5/0.5)	Silky shade (Munsell 1Y8.5/0.5)	Silky shade (Munsell 1Y8.5/0.5)
Compressor	Type		Hermetic twin rotary compressor	Hermetic twin rotary compressor	Hermetic twin rotary compressor	Hermetic twin rotary compressor
	Motor output	kW	3.0 x 2 + 3.0 x 2	4.0 x 2 + 3.0 x 2	5.4 x 2 + 3.0 x 2	5.4 x 2 + 4.0 x 2
Fan unit	Type		Propeller fan	Propeller fan	Propeller fan	Propeller fan
	Motor output	kW	1.0 + 1.0	1.0 + 1.0	1.0+1.0 + 1.0	1.0+1.0 + 1.0
	Air volume	cfm	7480 + 7480	7700 + 7480	10850 + 7480	10850 + 7700
Maximum external static pressure (*3)			In.WG	0.16	0.16	0.16
Heat exchanger			Finned tube	Finned tube	Finned tube	Finned tube
Refrigerant	Name		R410A	R410A	R410A	R410A
	Charged refrigerant amount (*4)	lbs	24.3 + 24.3	24.3 + 24.3	24.3 + 24.3	24.3 + 24.3
High-pressure switch			psi	OFF:420 ON:540	OFF:420 ON:540	OFF:420 ON:540
Protective devices				(*5)	(*5)	(*5)
Power supply wiring	MCA	A	34.2 + 34.2	45.4 + 34.2	52.1 + 34.2	52.1 + 45.4
	MOCOP (*6)	A	40 + 40	50 + 40	60 + 40	60 + 50
Piping connections	Liquid	Type	Flare	Flare	Flare	Flare
		Diameter	In	3/4"	3/4"	3/4"
	Suction Gas	Type	Brazing	Brazing	Brazing	Brazing
		Diameter	In	1-1/8"	1-3/8"	1-3/8"
	Discharge Gas	Type	Flare	Flare	Flare	Flare
		Diameter	In	7/8"	1-1/8"	1-1/8"
	Balance	Type	Flare	Flare	Flare	Flare
		Diameter	In	3/8"	3/8"	3/8"
Indoor units	Maximum capacity of combined indoor units		50 to 150%(*7)	50 to 150%(*7)	50 to 150%(*7)	50 to 150%(*7)
	Maximum number of indoor units(*8)		34	38	42	46
Sound pressure level	Cooling	dB(A)	65.0	65.5	68.0	68.5
	Heating	dB(A)	65.0	66.5	68.0	68.5
Operation temperature range	Cooling	°FDB	14 to 122	14 to 122	14 to 122	14 to 122
	Heating	°FWB	-13 to 60	-13 to 60	-13 to 60	-13 to 60

- Note
- (*1) Rated conditions Cooling : Indoor air temperature 80 F Dry Bulb / 67 F Wet Bulb , Outdoor air tempreture 95 F Dry Bulb.
Heating : Indoor air temperature 70 F Dry Bulb, Outdoor air tempreture 47 F Dry Bulb / 43 F Wet Bulb.
Equivalent piping length: 100 ft, Height difference: 0 ft
 - (*2) Value for only outdoor unit
 - (*3) Setting is necessary
 - (*4) The amount dose not consider extra piping length. Refrigerant must be added on site in accordance with the actual piping length.
 - (*5) Discharge temp. sensor / Suction temp. sensor / High-pressure sensor / Low-pressure sensor / PC board fuse
 - (*6) MOCOP : Maximum Overcurrent Protection(Amps)
 - (*7) Permanent operation below 80% is not recommended.
 - (*8) It is 54 units in case central control is in system.

System with Non-ducted indoor units

Model name			MMY-AP2886FT9P-UL	MMY-AP3126FT9P-UL
Outdoor unit model name			MMY-MAP1446FT9P-UL	MMY-MAP1686FT9P-UL
			MMY-MAP1446FT9P-UL	MMY-MAP1446FT9P-UL
Power Supply	Nominal voltage	V/Ph/Hz	208-230 / 3 / 60	
	Voltage range	V	187Minimum / 253 Maximum	
Cooling	Nominal capacity (*1)	Btu/h	288,000	312,000
	Rated capacity (*1)	Btu/h	276,000	298,000
	Rated power consumption (*1)(*2)	kW	24.14	28.14
	Rated EER (*1)(*2)	(Btu/h)/W	11.4	10.6
Heating	Nominal capacity (*1)	Btu/h	324,000	351,000
	Rated capacity (*1)	Btu/h	308,000	334,000
	Rated power consumption (*1)(*2)	kW	25.50	28.98
	Rated COP (*1)(*2)	W/W	3.54	3.38
Weight	Unit	lbs	882 + 882	882 + 882
	Packing	lbs	924 + 924	924 + 924
Color			Silky shade (Munsell 1Y8.5/0.5)	Silky shade (Munsell 1Y8.5/0.5)
Compressor	Type		Hermetic twin rotary compressor	
	Motor output	kW	5.4 x 2 + 5.4 x 2	6.5 x 2 + 5.4 x 2
Fan unit	Type		Propeller fan	
	Motor output	kW	1.0+1.0 + 1.0+1.0	1.0+1.0 + 1.0+1.0
	Air volume	cfm	10850 + 10850	10850 + 10850
Maximum external static pressure (*3)			In.WG	0.16
Heat exchanger			Finned tube	Finned tube
Refrigerant	Name		R410A	
	Charged refrigerant amount (*4)	lbs	24.3 + 24.3	24.3 + 24.3
High-pressure switch			psi	OFF:420 ON:540
Protective devices			(*5)	(*5)
Power supply wiring	MCA	A	52.1 + 52.1	66.2 + 52.1
	MOCP (*6)	A	60 + 60	70 + 60
Piping connections	Liquid	Type	Flare	
		Diameter	In	7/8"
	Suction Gas	Type	Brazing	
		Diameter	In	1-3/8"
	Discharge Gas	Type	Flare	
		Diameter	In	1-1/8"
Balance	Type	Flare		
	Diameter	In	3/8"	
Indoor units	Maximum capacity of combined indoor units		50 to 150%(*7)	50 to 150%(*7)
	Maximum number of indoor units(*8)		50	55
Sound pressure level	Cooling	dB(A)	69.5	69.5
	Heating	dB(A)	69.5	70.0
Operation temperature range	Cooling	°FDB	14 to 122	14 to 122
	Heating	°FWB	-13 to 60	-13 to 60

Note

(*1) Rated conditions Cooling : Indoor air temperature 80 F Dry Bulb / 67 F Wet Bulb , Outdoor air temperture 95 F Dry Bulb.
 Heating : Indoor air temperature 70 F Dry Bulb, Outdoor air temperture 47 F Dry Bulb / 43 F Wet Bulb.
 Equivalent piping length: 100 ft, Height difference: 0 ft

(*2) Value for only outdoor unit

(*3) Setting is necessary

(*4) The amount dose not consider extra piping length. Refrigerant must be added on site in accordance with the actual piping length.

(*5) Discharge temp. sensor / Suction temp. sensor / High-pressure sensor / Low-pressure sensor / PC board fuse

(*6) MOCP : Maximum Overcurrent Protection(Amps)

(*7) Permanent operation below 80% is not recommended.

(*8) It is 54 units in case central control is in system.

System with Non-ducted indoor units

Model name			MMY-AP3366FT9P-UL	MMY-AP3606FT9P-UL	MMY-AP3846FT9P-UL	MMY-AP4086FT9P-UL
Outdoor unit model name			MMY-MAP1206FT9P-UL	MMY-MAP1206FT9P-UL	MMY-MAP1446FT9P-UL	MMY-MAP1446FT9P-UL
			MMY-MAP1206FT9P-UL	MMY-MAP1206FT9P-UL	MMY-MAP1206FT9P-UL	MMY-MAP1446FT9P-UL
			MMY-MAP0966FT9P-UL	MMY-MAP1206FT9P-UL	MMY-MAP1206FT9P-UL	MMY-MAP1206FT9P-UL
Power Supply	Nominal voltage	V/Ph/Hz	208-230 / 3 / 60		208-230 / 3 / 60	
	Voltage range	V	187Minimum / 253 Maximum		187Minimum / 253 Maximum	
Cooling	Nominal capacity (*1)	Btu/h	336,000	360,000	384,000	408,000
	Rated capacity (*1)	Btu/h	320,000	342,000	366,000	390,000
	Rated power consumption (*1)(*2)	kW	29.11	34.26	36.70	39.49
	Rated EER (*1)(*2)	(Btu/h)/W	11.0	9.98	9.97	9.88
Heating	Nominal capacity (*1)	Btu/h	378,000	405,000	432,000	459,000
	Rated capacity (*1)	Btu/h	360,000	386,000	412,000	436,000
	Rated power consumption (*1)(*2)	kW	30.23	33.48	36.34	38.73
	Rated COP (*1)(*2)	W/W	3.49	3.38	3.32	3.30
Weight	Unit	lbs	721 + 721 + 721	721 + 721 + 721	882 + 721 + 721	882 + 882 + 721
	Packing	lbs	761 + 761 + 761	761 + 761 + 761	924 + 761 + 761	924 + 924 + 761
Color			Silky shade (Munsell 1Y8.5/0.5)	Silky shade (Munsell 1Y8.5/0.5)	Silky shade (Munsell 1Y8.5/0.5)	Silky shade (Munsell 1Y8.5/0.5)
Compressor	Type		Hermetic twin rotary compressor	Hermetic twin rotary compressor	Hermetic twin rotary compressor	Hermetic twin rotary compressor
	Motor output	kW	4.0 x 2 + 4.0 x 2 + 3.0 x 2	4.0 x 2 + 4.0 x 2 + 4.0 x 2	5.4 x 2 + 4.0 x 2 + 4.0 x 2	5.4 x 2 + 5.4 x 2 + 4.0 x 2
Fan unit	Type		Propeller fan	Propeller fan	Propeller fan	Propeller fan
	Motor output	kW	1.0 + 1.0 + 1.0	1.0 + 1.0 + 1.0	1.0+1.0 + 1.0 + 1.0	1.0+1.0 + 1.0+1.0 + 1.0
	Air volume	cfm	7700 + 7700 + 7480	7700 + 7700 + 7700	10850 + 7700 + 7700	10850 + 10850 + 7700
Maximum external static pressure (*3)			In.WG	0.16	0.16	0.16
Heat exchanger			Finned tube	Finned tube	Finned tube	Finned tube
Refrigerant	Name		R410A	R410A	R410A	R410A
	Charged refrigerant amount (*4)	lbs	24.3 + 24.3 + 24.3	24.3 + 24.3 + 24.3	24.3 + 24.3 + 24.3	24.3 + 24.3 + 24.3
High-pressure switch			psi	OFF:420 ON:540	OFF:420 ON:540	OFF:420 ON:540
Protective devices				(*5)	(*5)	(*5)
Power supply wiring	MCA	A	45.4 + 45.4 + 34.2	45.4 + 45.4 + 45.4	52.1 + 45.4 + 45.4	52.1 + 52.1 + 45.4
	MOCP (*6)	A	50 + 50 + 40	50 + 50 + 50	60 + 50 + 50	60 + 60 + 50
Piping connections	Liquid	Type	Flare	Flare	Flare	Flare
		Diameter	In	7/8"	7/8"	7/8"
	Suction Gas	Type	Brazing	Brazing	Brazing	Brazing
		Diameter	In	1-3/8"	1-5/8"	1-5/8"
	Discharge Gas	Type	Flare	Flare	Flare	Flare
		Diameter	In	1-1/8"	1-3/8"	1-3/8"
	Balance	Type	Flare	Flare	Flare	Flare
		Diameter	In	3/8"	3/8"	3/8"
Indoor units	Maximum capacity of combined indoor units		50 to 150%(*7)	50 to 150%(*7)	50 to 150%(*7)	50 to 150%(*7)
	Maximum number of indoor units(*8)		60	63	64	64
Sound pressure level	Cooling	dB(A)	67.5	68.0	69.5	70.5
	Heating	dB(A)	68.5	69.0	70.0	71.0
Operation temperature range	Cooling	°FDB	14 to 122	14 to 122	14 to 122	14 to 122
	Heating	°FWB	-13 to 60	-13 to 60	-13 to 60	-13 to 60

Note

- (*1) Rated conditions Cooling : Indoor air temperature 80 F Dry Bulb / 67 F Wet Bulb , Outdoor air temperature 95 F Dry Bulb.
Heating : Indoor air temperature 70 F Dry Bulb, Outdoor air temperature 47 F Dry Bulb / 43 F Wet Bulb.
336 type : Equivalent piping length: 100 ft, Height difference: 0 ft, 360, 384, 408 type : Equivalent piping length: 150 ft, Height difference: 0 ft
- (*2) Value for only outdoor unit
- (*3) Setting is necessary
- (*4) The amount dose not consider extra piping length. Refrigerant must be added on site in accordance with the actual piping length.
- (*5) Discharge temp. sensor / Suction temp. sensor / High-pressure sensor / Low-pressure sensor / PC board fuse
- (*6) MOCP : Maximum Overcurrent Protection(Amps)
- (*7) Permanent operation below 80% is not recommended.
- (*8) It is 54 units in case central control is in system.

System with Non-ducted indoor units

Model name			MMY-AP4326FT9P-UL	MMY-AP4566FT9P-UL
Outdoor unit model name			MMY-MAP1446FT9P-UL	MMY-MAP1686FT9P-UL
			MMY-MAP1446FT9P-UL	MMY-MAP1446FT9P-UL
			MMY-MAP1446FT9P-UL	MMY-MAP1446FT9P-UL
Power Supply	Nominal voltage	V/Ph/Hz	208-230 / 3 / 60	
	Voltage range	V	187Minimum / 253 Maximum	
Cooling	Nominal capacity (*1)	Btu/h	432,000	456,000
	Rated capacity (*1)	Btu/h	412,000	434,000
	Rated power consumption (*1)(*2)	kW	41.28	46.39
	Rated EER (*1)(*2)	(Btu/h)/W	9.98	9.36
Heating	Nominal capacity (*1)	Btu/h	486,000	513,000
	Rated capacity (*1)	Btu/h	462,000	488,000
	Rated power consumption (*1)(*2)	kW	40.99	43.60
	Rated COP (*1)(*2)	W/W	3.30	3.28
Weight	Unit	lbs	882 + 882 + 882	
	Packing	lbs	924 + 924 + 924	
Color			Silky shade (Munsell 1Y8.5/0.5)	
Compressor	Type		Hermetic twin rotary compressor	
	Motor output	kW	5.4 x 2 + 5.4 x 2 + 5.4 x 2	
Fan unit	Type		Propeller fan	
	Motor output	kW	1.0+1.0 + 1.0+1.0 + 1.0+1.0	
	Air volume	cfm	10850 + 10850 + 10850	
Maximum external static pressure (*3)			In.WG 0.16	
Heat exchanger			Finned tube	
Refrigerant	Name		R410A	
	Charged refrigerant amount (*4)	lbs	24.3 + 24.3 + 24.3	
High-pressure switch			psi OFF:420 ON:540	
Protective devices			(*5)	
Power supply wiring	MCA	A	52.1 + 52.1 + 52.1	
	MOCP (*6)	A	60 + 60 + 60	
Piping connections	Liquid	Type	Flare	
		Diameter	7/8"	
	Suction Gas	Type	Brazing	
		Diameter	1-5/8"	
	Discharge Gas	Type	Flare	
		Diameter	1-3/8"	
	Balance	Type	Flare	
		Diameter	3/8"	
Indoor units	Maximum capacity of combined indoor units		50 to 150%(*7)	
	Maximum number of indoor units(*8)		64	
Sound pressure level	Cooling	dB(A)	71.5	
	Heating	dB(A)	71.5	
Operation temperature range	Cooling	°FDB	14 to 122	
	Heating	°FWB	-13 to 60	

Note

(*1) Rated conditions Cooling : Indoor air temperature 80 F Dry Bulb / 67 F Wet Bulb , Outdoor air temperture 95 F Dry Bulb.
 Heating : Indoor air temperature 70 F Dry Bulb, Outdoor air temperture 47 F Dry Bulb / 43 F Wet Bulb.
 Equivalent piping length: 150 ft, Height difference: 0 ft

(*2) Value for only outdoor unit

(*3) Setting is necessary

(*4) The amount dose not consider extra piping length. Refrigerant must be added on site in accordance with the actual piping length.

(*5) Discharge temp. sensor / Suction temp. sensor / High-pressure sensor / Low-pressure sensor / PC board fuse

(*6) MOCP : Maximum Overcurrent Protection(Amps)

(*7) Permanent operation below 80% is not recommended.

(*8) It is 54 units in case central control is in system.

System with Non-ducted indoor units

Model name			MMY-AP192S6FT9P-UL	MMY-AP240S6FT9P-UL	MMY-AP288S6FT9P-UL	MMY-AP336S6FT9P-UL
Outdoor unit model name			MMY-MAP1206FT9P-UL	MMY-MAP1206FT9P-UL	MMY-MAP1686FT9P-UL	MMY-MAP1686FT9P-UL
			MMY-MAP0726FT9P-UL	MMY-MAP1206FT9P-UL	MMY-MAP1206FT9P-UL	MMY-MAP1686FT9P-UL
			-	-	-	0.0
Power Supply	Nominal voltage	V/Ph/Hz	208-230 / 3 / 60	208-230 / 3 / 60	208-230 / 3 / 60	208-230 / 3 / 60
	Voltage range	V	187Minimum / 253 Maximum	187Minimum / 253 Maximum	187Minimum / 253 Maximum	187Minimum / 253 Maximum
Cooling	Nominal capacity (*1)	Btu/h	192,000	240,000	288,000	336,000
	Rated capacity (*1)	Btu/h	184,000	230,000	276,000	320,000
	Rated power consumption (*1)(*2)	kW	15.29	20.91	26.12	30.88
	Rated EER (*1)(*2)	(Btu/h)/W	12.0	11.0	10.6	10.4
Heating	Nominal capacity (*1)	Btu/h	216,000	270,000	324,000	378,000
	Rated capacity (*1)	Btu/h	206,000	256,000	308,000	360,000
	Rated power consumption (*1)(*2)	kW	16.36	20.90	26.28	31.66
	Rated COP (*1)(*2)	W/W	3.69	3.59	3.43	3.33
Weight	Unit	lbs	721 + 600	721 + 721	882 + 721	882 + 882
	Packing	lbs	761 + 635	761 + 761	924 + 761	924 + 924
Color			Silky shade (Munsell 1Y8.5/0.5)	Silky shade (Munsell 1Y8.5/0.5)	Silky shade (Munsell 1Y8.5/0.5)	Silky shade (Munsell 1Y8.5/0.5)
Compressor	Type		Hermetic twin rotary compressor	Hermetic twin rotary compressor	Hermetic twin rotary compressor	Hermetic twin rotary compressor
	Motor output	kW	4.0 x 2 + 2.1 x 2	4.0 x 2 + 4.0 x 2	6.5 x 2 + 4.0 x 2	6.5 x 2 + 6.5 x 2
Fan unit	Type		Propeller fan	Propeller fan	Propeller fan	Propeller fan
	Motor output	kW	1.0 + 1.0	1.0 + 1.0	1.0+1.0 + 1.0	1.0+1.0 + 1.0+1.0
	Air volume	cfm	7700 + 5900	7700 + 7700	10850 + 7700	10850 + 10850
Maximum external static pressure (*3)			In.WG	0.16	0.16	0.16
Heat exchanger			Finned tube	Finned tube	Finned tube	Finned tube
Refrigerant	Name		R410A	R410A	R410A	R410A
	Charged refrigerant amount (*4)	kg	24.3 + 24.3	24.3 + 24.3	24.3 + 24.3	24.3 + 24.3
High-pressure switch			psi	OFF:420 ON:540	OFF:420 ON:540	OFF:420 ON:540
Protective devices				(*5)	(*5)	(*5)
Power supply wiring	MCA	A	45.4 + 23.3	45.4 + 45.4	66.2 + 45.4	66.2 + 66.2
	MOCP (*6)	A	50 + 30	50 + 50	70 + 50	70 + 70
Piping connections	Liquid	Type	Flare	Flare	Flare	Flare
		Diameter	In	7/8"	7/8"	7/8"
	Suction Gas	Type	Brazing	Brazing	Brazing	Brazing
		Diameter	In	1-1/8"	1-3/8"	1-3/8"
	Discharge Gas	Type	Flare	Flare	Flare	Flare
		Diameter	In	7/8"	1-1/8"	1-1/8"
	Balance	Type	Flare	Flare	Flare	Flare
		Diameter	In	3/8"	3/8"	3/8"
Indoor units	Maximum capacity of combined indoor units		50 to 150%(*7)	50 to 150%(*7)	50 to 150%(*7)	50 to 150%(*7)
	Maximum number of indoor units(*8)		34	42	50	60
Sound pressure level	Cooling	dB(A)	64.0	66.0	68.5	69.5
	Heating	dB(A)	65.5	67.0	69.0	70.0
Operation temperature range	Cooling	°FDB	14 to 122	14 to 122	14 to 122	14 to 122
	Heating	°FWB	-13 to 60	-13 to 60	-13 to 60	-13 to 60

Note

(*1) Rated conditions Cooling : Indoor air temperature 80 F Dry Bulb / 67 F Wet Bulb , Outdoor air temperature 95 F Dry Bulb.
 Heating : Indoor air temperature 70 F Dry Bulb, Outdoor air temperature 47 F Dry Bulb / 43 F Wet Bulb.
 Equivalent piping length: 100 ft, Height difference: 0 ft

(*2) Value for only outdoor unit

(*3) Setting is necessary

(*4) The amount dose not consider extra piping length. Refrigerant must be added on site in accordance with the actual piping length.

(*5) Discharge temp. sensor / Suction temp. sensor / High-pressure sensor / Low-pressure sensor / PC board fuse

(*6) MOCP : Maximum Overcurrent Protection(Amps)

(*7) Permanent operation below 80% is not recommended.

(*8) It is 54 units in case central control is in system.



System with Ducted indoor units

Model name			MMY-MAP0726FT9P-UL	MMY-MAP0966FT9P-UL	MMY-MAP1206FT9P-UL
Power Supply	Nominal voltage	V/Ph/Hz	208-230 / 3 / 60		
	Voltage range	V	187Minimum / 253 Maximum		
Cooling	Nominal capacity (*1)	Btu/h	72000	96000	120000
	Rated capacity (*1)	Btu/h	69000	92000	114000
	Rated power consumption (*1)(*2)	kW	5.11	7.34	9.05
	Rated EER (*1)(*2)	(Btu/h)/W	13.5	12.5	12.6
Heating	Nominal capacity (*1)	Btu/h	81000	108000	135000
	Rated capacity (*1)	Btu/h	77000	103000	129000
	Rated power consumption (*1)(*2)	kW	6.25	7.61	10.34
	Rated COP (*1)(*2)	W/W	3.61	3.97	3.66
Dimension	Unit	Height	In	72.9	72.9
		Width	In	39.0	47.6
		Depth	In	30.7	30.7
	Packing	Height	In	76.3	76.3
		Width	In	41.8	50.5
		Depth	In	32.6	32.6
Weight	Unit	lbs	600	721	721
	Packing	lbs	635	761	761
Color			Silky shade (Munsell 1Y8.5/0.5)	Silky shade (Munsell 1Y8.5/0.5)	Silky shade (Munsell 1Y8.5/0.5)
Compressor	Type		Hermetic twin rotary compressor		
	Motor output	kW	2.1 x 2	3.0 x 2	4.0 x 2
Fan unit	Type		Propeller fan		
	Motor output	kW	1.0	1.0	1.0
	Air volume	cfm	5900	7480	7700
Maximum external static pressure (*3)			In.WG	0.24	0.16
Heat exchanger			Finned tube	Finned tube	Finned tube
Refrigerant	Name		R410A		
	Charged refrigerant amount (*4)	lbs	24.3	24.3	24.3
High-pressure switch			psi	OFF:420 ON:540	OFF:420 ON:540
Protective devices				(*5)	(*5)
Power supply wiring	MCA	A	23.3	34.2	45.4
	MOCP (*6)	A	30.0	40.0	50.0
Piping connections	Liquid	Type	Flare		
		Diameter	In	1/2"	1/2"
	Suction Gas	Type	Brazing		
		Diameter	In	7/8"	7/8"
	Discharge Gas	Type	Flare		
		Diameter	In	3/4"	3/4"
Balance	Type	Flare			
	Diameter	In	3/8"	3/8"	
Indoor units	Maximum capacity of combined indoor units		50 to 150%(*7)	50 to 150%(*7)	50 to 150%(*7)
	Maximum number of indoor units(*8)		12	16	21
Sound pressure level	Cooling	dB(A)	57.0	62.0	63.0
	Heating	dB(A)	60.0	62.0	64.0
Operation temperature range	Cooling	°FDB	14 to 122	14 to 122	14 to 122
	Heating	°FWB	-13 to 60	-13 to 60	-13 to 60

Note

(*1) Rated conditions Cooling : Indoor air temperature 80 F Dry Bulb / 67 F Wet Bulb , Outdoor air temperture 95 F Dry Bulb.
 Heating : Indoor air temperature 70 F Dry Bulb, Outdoor air temperture 47 F Dry Bulb / 43 F Wet Bulb.
 Equivalent piping length : 25 ft, Height difference : 0 ft

(*2) Value for only outdoor unit

(*3) Setting is necessary

(*4) The amount dose not consider extra piping length. Refrigerant must be added on site in accordance with the actual piping length.

(*5) Discharge temp. sensor / Suction temp. sensor / High-pressure sensor / Low-pressure sensor / PC board fuse

(*6) MOCP : Maximum Overcurrent Protection(Amps)

(*7) Permanent operation below 80% is not recommended.

(*8) It is 54 units in case central control is in system.

System with Ducted indoor units

Model name			MMY-MAP1446FT9P-UL	MMY-MAP1686FT9P-UL	
Power Supply	Nominal voltage	V/Ph/Hz	208-230 / 3 / 60	208-230 / 3 / 60	
	Voltage range	V	187Minimum / 253 Maximum	187Minimum / 253 Maximum	
Cooling	Nominal capacity (*1)	Btu/h	144000	168000	
	Rated capacity (*1)	Btu/h	138000	160000	
	Rated power consumption (*1)(*2)	kW	11.29	14.48	
	Rated EER (*1)(*2)	(Btu/h)/W	12.2	11.1	
Heating	Nominal capacity (*1)	Btu/h	162000	189000	
	Rated capacity (*1)	Btu/h	154000	180000	
	Rated power consumption (*1)(*2)	kW	12.02	15.38	
	Rated COP (*1)(*2)	W/W	3.75	3.43	
Dimension	Unit	Height	In	72.9	72.9
		Width	In	63.0	63.0
		Depth	In	30.7	30.7
	Packing	Height	In	76.3	76.3
		Width	In	65.8	65.8
		Depth	In	32.6	32.6
Weight	Unit	lbs	882	882	
	Packing	lbs	924	924	
Color			Silky shade (Munsell 1Y8.5/0.5)	Silky shade (Munsell 1Y8.5/0.5)	
Compressor	Type		Hermetic twin rotary compressor	Hermetic twin rotary compressor	
	Motor output	kW	5.4 x 2	6.5 x 2	
Fan unit	Type		Propeller fan	Propeller fan	
	Motor output	kW	1.0+1.0	1.0+1.0	
	Air volume	cfm	10850	10850	
Maximum external static pressure (*3)		In.WG	0.16	0.16	
Heat exchanger			Finned tube	Finned tube	
Refrigerant	Name		R410A	R410A	
	Charged refrigerant amount (*4)	lbs	24.3	24.3	
High-pressure switch		psi	OFF:420 ON:540	OFF:420 ON:540	
Protective devices			(*5)	(*5)	
Power supply wiring	MCA	A	52.1	66.2	
	MOCP (*6)	A	60.0	70.0	
Piping connections	Liquid	Type	Flare	Flare	
		Diameter	In	5/8"	3/4"
	Suction Gas	Type	Brazing	Brazing	
		Diameter	In	1-1/8"	1-1/8"
	Discharge Gas	Type	Flare	Flare	
		Diameter	In	7/8"	7/8"
	Balance	Type	Flare	Flare	
		Diameter	In	3/8"	3/8"
Indoor units	Maximum capacity of combined indoor units		50 to 150%(*7)	50 to 150%(*7)	
	Maximum number of indoor units(*8)		25	30	
Sound pressure level	Cooling	dB(A)	66.5	66.5	
	Heating	dB(A)	66.5	67.0	
Operation temperature range	Cooling	°FDB	14 to 122	14 to 122	
	Heating	°FWB	-13 to 60	-13 to 60	

Note

(*1) Rated conditions Cooling : Indoor air temperature 80 F Dry Bulb / 67 F Wet Bulb , Outdoor air temperture 95 F Dry Bulb.
 Heating : Indoor air temperature 70 F Dry Bulb, Outdoor air temperture 47 F Dry Bulb / 43 F Wet Bulb.
 Equivalent piping length: 50 ft, Height difference: 0 ft

(*2) Value for only outdoor unit

(*3) Setting is necessary

(*4) The amount dose not consider extra piping length. Refrigerant must be added on site in accordance with the actual piping length.

(*5) Discharge temp. sensor / Suction temp. sensor / High-pressure sensor / Low-pressure sensor / PC board fuse

(*6) MOCP : Maximum Overcurrent Protection(Amps)

(*7) Permanent operation below 80% is not recommended.

(*8) It is 54 units in case central control is in system.

System with Ducted indoor units

Model name			MMY-AP1926FT9P-UL	MMY-AP2166FT9P-UL	MMY-AP2406FT9P-UL	MMY-AP2646FT9P-UL
Outdoor unit model name			MMY-MAP0966FT9P-UL	MMY-MAP1206FT9P-UL	MMY-MAP1446FT9P-UL	MMY-MAP1446FT9P-UL
			MMY-MAP0966FT9P-UL	MMY-MAP0966FT9P-UL	MMY-MAP0966FT9P-UL	MMY-MAP1206FT9P-UL
Power Supply	Nominal voltage	V/Ph/Hz	208-230 / 3 / 60	208-230 / 3 / 60	208-230 / 3 / 60	208-230 / 3 / 60
	Voltage range	V	187Minimum / 253 Maximum	187Minimum / 253 Maximum	187Minimum / 253 Maximum	187Minimum / 253 Maximum
Cooling	Nominal capacity (*1)	Btu/h	192,000	216,000	240,000	264,000
	Rated capacity (*1)	Btu/h	184,000	206,000	230,000	252,000
	Rated power consumption (*1)(*2)	kW	14.91	17.29	19.26	22.01
	Rated EER (*1)(*2)	(Btu/h)/W	12.3	11.9	11.9	11.5
Heating	Nominal capacity (*1)	Btu/h	216,000	243,000	270,000	297,000
	Rated capacity (*1)	Btu/h	206,000	232,000	256,000	282,000
	Rated power consumption (*1)(*2)	kW	15.36	17.09	19.99	22.80
	Rated COP (*1)(*2)	W/W	3.93	3.98	3.75	3.62
Weight	Unit	lbs	721 + 721	721 + 721	882 + 721	882 + 721
	Packing	lbs	761 + 761	761 + 761	924 + 761	924 + 761
Color			Silky shade (Munsell 1Y8.5/0.5)	Silky shade (Munsell 1Y8.5/0.5)	Silky shade (Munsell 1Y8.5/0.5)	Silky shade (Munsell 1Y8.5/0.5)
Compressor	Type		Hermetic twin rotary compressor	Hermetic twin rotary compressor	Hermetic twin rotary compressor	Hermetic twin rotary compressor
	Motor output	kW	3.0 x 2 + 3.0 x 2	4.0 x 2 + 3.0 x 2	5.4 x 2 + 3.0 x 2	5.4 x 2 + 4.0 x 2
Fan unit	Type		Propeller fan	Propeller fan	Propeller fan	Propeller fan
	Motor output	kW	1.0 + 1.0	1.0 + 1.0	1.0+1.0 + 1.0	1.0+1.0 + 1.0
	Air volume	cfm	7480 + 7480	7700 + 7480	10850 + 7480	10850 + 7700
Maximum external static pressure (*3)			In.WG	0.16	0.16	0.16
Heat exchanger			Finned tube	Finned tube	Finned tube	Finned tube
Refrigerant	Name		R410A	R410A	R410A	R410A
	Charged refrigerant amount (*4)	lbs	24.3 + 24.3	24.3 + 24.3	24.3 + 24.3	24.3 + 24.3
High-pressure switch			psi	OFF:420 ON:540	OFF:420 ON:540	OFF:420 ON:540
Protective devices				(*5)	(*5)	(*5)
Power supply wiring	MCA	A	34.2 + 34.2	45.4 + 34.2	52.1 + 34.2	52.1 + 45.4
	MOCP (*6)	A	40 + 40	50 + 40	60 + 40	60 + 50
Piping connections	Liquid	Type	Flare	Flare	Flare	Flare
		Diameter	In	3/4"	3/4"	3/4"
	Suction Gas	Type	Brazing	Brazing	Brazing	Brazing
		Diameter	In	1-1/8"	1-3/8"	1-3/8"
	Discharge Gas	Type	Flare	Flare	Flare	Flare
		Diameter	In	7/8"	1-1/8"	1-1/8"
	Balance	Type	Flare	Flare	Flare	Flare
		Diameter	In	3/8"	3/8"	3/8"
Indoor units	Maximum capacity of combined indoor units		50 to 150%(*7)	50 to 150%(*7)	50 to 150%(*7)	50 to 150%(*7)
	Maximum number of indoor units(*8)		34	38	42	46
Sound pressure level	Cooling	dB(A)	65.0	65.5	68.0	68.5
	Heating	dB(A)	65.0	66.5	68.0	68.5
Operation temperature range	Cooling	°FDB	14 to 122	14 to 122	14 to 122	14 to 122
	Heating	°FWB	-13 to 60	-13 to 60	-13 to 60	-13 to 60

Note

(*1) Rated conditions Cooling : Indoor air temperature 80 F Dry Bulb / 67 F Wet Bulb , Outdoor air temperature 95 F Dry Bulb.
 Heating : Indoor air temperature 70 F Dry Bulb, Outdoor air temperature 47 F Dry Bulb / 43 F Wet Bulb.
 Equivalent piping length: 50 ft, Height difference: 0 ft

(*2) Value for only outdoor unit

(*3) Setting is necessary

(*4) The amount dose not consider extra piping length. Refrigerant must be added on site in accordance with the actual piping length.

(*5) Discharge temp. sensor / Suction temp. sensor / High-pressure sensor / Low-pressure sensor / PC board fuse

(*6) MOCP : Maximum Overcurrent Protection(Amps)

(*7) Permanent operation below 80% is not recommended.

(*8) It is 54 units in case central control is in system.



System with Ducted indoor units

Model name			MMY-AP2886FT9P-UL	MMY-AP3126FT9P-UL
Outdoor unit model name			MMY-MAP1446FT9P-UL	MMY-MAP1686FT9P-UL
			MMY-MAP1446FT9P-UL	MMY-MAP1446FT9P-UL
Power Supply	Nominal voltage	V/Ph/Hz	208-230 / 3 / 60	
	Voltage range	V	187Minimum / 253 Maximum	
Cooling	Nominal capacity (*1)	Btu/h	288,000	312,000
	Rated capacity (*1)	Btu/h	276,000	298,000
	Rated power consumption (*1)(*2)	kW	23.96	28.61
	Rated EER (*1)(*2)	(Btu/h)/W	11.5	10.4
Heating	Nominal capacity (*1)	Btu/h	324,000	351,000
	Rated capacity (*1)	Btu/h	308,000	334,000
	Rated power consumption (*1)(*2)	kW	24.97	28.61
	Rated COP (*1)(*2)	W/W	3.62	3.42
Weight	Unit	lbs	882 + 882	882 + 882
	Packing	lbs	924 + 924	924 + 924
Color			Silky shade (Munsell 1Y8.5/0.5)	Silky shade (Munsell 1Y8.5/0.5)
Compressor	Type		Hermetic twin rotary compressor	
	Motor output	kW	5.4 x 2 + 5.4 x 2	6.5 x 2 + 5.4 x 2
Fan unit	Type		Propeller fan	
	Motor output	kW	1.0+1.0 + 1.0+1.0	1.0+1.0 + 1.0+1.0
	Air volume	cfm	10850 + 10850	10850 + 10850
Maximum external static pressure (*3)			In.WG	0.16
Heat exchanger			Finned tube	Finned tube
Refrigerant	Name		R410A	
	Charged refrigerant amount (*4)	lbs	24.3 + 24.3	24.3 + 24.3
High-pressure switch			psi	OFF:420 ON:540
Protective devices				(*5)
Power supply wiring	MCA	A	52.1 + 52.1	66.2 + 52.1
	MOCP (*6)	A	60 + 60	70 + 60
Piping connections	Liquid	Type	Flare	
		Diameter	7/8"	
	Suction Gas	Type	Brazing	
		Diameter	1-3/8"	
	Discharge Gas	Type	Flare	
		Diameter	1-1/8"	
	Balance	Type	Flare	
		Diameter	3/8"	
Indoor units	Maximum capacity of combined indoor units		50 to 150%(*7)	50 to 150%(*7)
	Maximum number of indoor units(*8)		50	55
Sound pressure level	Cooling	dB(A)	69.5	69.5
	Heating	dB(A)	69.5	70.0
Operation temperature range	Cooling	*FDB	14 to 122	14 to 122
	Heating	*FWB	-13 to 60	-13 to 60

- Note
- (*1) Rated conditions Cooling : Indoor air temperature 80 F Dry Bulb / 67 F Wet Bulb , Outdoor air temperature 95 F Dry Bulb.
Heating : Indoor air temperature 70 F Dry Bulb, Outdoor air temperature 47 F Dry Bulb / 43 F Wet Bulb.
Equivalent piping length: 50 ft, Height difference: 0 ft
 - (*2) Value for only outdoor unit
 - (*3) Setting is necessary
 - (*4) The amount dose not consider extra piping length. Refrigerant must be added on site in accordance with the actual piping length.
 - (*5) Discharge temp. sensor / Suction temp. sensor / High-pressure sensor / Low-pressure sensor / PC board fuse
 - (*6) MOCP : Maximum Overcurrent Protection(Amps)
 - (*7) Permanent operation below 80% is not recommended.
 - (*8) It is 54 units in case central control is in system.

System with Ducted indoor units

Model name			MMY-AP3366FT9P-UL	MMY-AP3606FT9P-UL	MMY-AP3846FT9P-UL	MMY-AP4086FT9P-UL
Outdoor unit model name			MMY-MAP1206FT9P-UL	MMY-MAP1206FT9P-UL	MMY-MAP1446FT9P-UL	MMY-MAP1446FT9P-UL
			MMY-MAP1206FT9P-UL	MMY-MAP1206FT9P-UL	MMY-MAP1206FT9P-UL	MMY-MAP1446FT9P-UL
			MMY-MAP0966FT9P-UL	MMY-MAP1206FT9P-UL	MMY-MAP1206FT9P-UL	MMY-MAP1206FT9P-UL
Power Supply	Nominal voltage	V/Ph/Hz	208-230 / 3 / 60	208-230 / 3 / 60	208-230 / 3 / 60	208-230 / 3 / 60
	Voltage range	V	187Minimum / 253 Maximum	187Minimum / 253 Maximum	187Minimum / 253 Maximum	187Minimum / 253 Maximum
Cooling	Nominal capacity (*1)	Btu/h	336,000	360,000	384,000	408,000
	Rated capacity (*1)	Btu/h	320,000	342,000	366,000	390,000
	Rated power consumption (*1)(*2)	kW	30.20	34.72	37.21	39.70
	Rated EER (*1)(*2)	(Btu/h)/W	10.6	9.85	9.84	9.82
Heating	Nominal capacity (*1)	Btu/h	378,000	405,000	432,000	459,000
	Rated capacity (*1)	Btu/h	360,000	386,000	412,000	436,000
	Rated power consumption (*1)(*2)	kW	30.63	32.39	35.72	37.84
	Rated COP (*1)(*2)	W/W	3.44	3.49	3.38	3.38
Weight	Unit	lbs	721 + 721 + 721	721 + 721 + 721	882 + 721 + 721	882 + 882 + 721
	Packing	lbs	761 + 761 + 761	761 + 761 + 761	924 + 761 + 761	924 + 924 + 761
Color			Silky shade (Munsell 1Y8.5/0.5)	Silky shade (Munsell 1Y8.5/0.5)	Silky shade (Munsell 1Y8.5/0.5)	Silky shade (Munsell 1Y8.5/0.5)
Compressor	Type		Hermetic twin rotary compressor	Hermetic twin rotary compressor	Hermetic twin rotary compressor	Hermetic twin rotary compressor
	Motor output	kW	4.0 x 2 + 4.0 x 2 + 3.0 x 2	4.0 x 2 + 4.0 x 2 + 4.0 x 2	5.4 x 2 + 4.0 x 2 + 4.0 x 2	5.4 x 2 + 5.4 x 2 + 4.0 x 2
Fan unit	Type		Propeller fan	Propeller fan	Propeller fan	Propeller fan
	Motor output	kW	1.0 + 1.0 + 1.0	1.0 + 1.0 + 1.0	1.0+1.0 + 1.0 + 1.0	1.0+1.0 + 1.0+1.0 + 1.0
	Air volume	cfm	7700 + 7700 + 7480	7700 + 7700 + 7700	10850 + 7700 + 7700	10850 + 10850 + 7700
Maximum external static pressure (*3)			In.WG	0.16	0.16	0.16
Heat exchanger			Finned tube	Finned tube	Finned tube	Finned tube
Refrigerant	Name		R410A	R410A	R410A	R410A
	Charged refrigerant amount (*4)	lbs	24.3 + 24.3 + 24.3	24.3 + 24.3 + 24.3	24.3 + 24.3 + 24.3	24.3 + 24.3 + 24.3
High-pressure switch			psi	OFF:420 ON:540	OFF:420 ON:540	OFF:420 ON:540
Protective devices				(*5)	(*5)	(*5)
Power supply wiring	MCA	A	45.4 + 45.4 + 34.2	45.4 + 45.4 + 45.4	52.1 + 45.4 + 45.4	52.1 + 52.1 + 45.4
	MOCP (*6)	A	50 + 50 + 40	50 + 50 + 50	60 + 50 + 50	60 + 60 + 50
Piping connections	Liquid	Type	Flare	Flare	Flare	Flare
		Diameter	In	7/8"	7/8"	7/8"
	Suction Gas	Type	Brazing	Brazing	Brazing	Brazing
		Diameter	In	1-3/8"	1-5/8"	1-5/8"
	Discharge Gas	Type	Flare	Flare	Flare	Flare
		Diameter	In	1-1/8"	1-3/8"	1-3/8"
	Balance	Type	Flare	Flare	Flare	Flare
		Diameter	In	3/8"	3/8"	3/8"
Indoor units	Maximum capacity of combined indoor units		50 to 150%(*7)	50 to 150%(*7)	50 to 150%(*7)	50 to 150%(*7)
	Maximum number of indoor units(*8)		60	63	64	64
Sound pressure level	Cooling	dB(A)	67.5	68.0	69.5	70.5
	Heating	dB(A)	68.5	69.0	70.0	71.0
Operation temperature range	Cooling	°FDB	14 to 122	14 to 122	14 to 122	14 to 122
	Heating	°FWB	-13 to 60	-13 to 60	-13 to 60	-13 to 60

Note

- (*1) Rated conditions Cooling : Indoor air temperature 80 F Dry Bulb / 67 F Wet Bulb , Outdoor air temperature 95 F Dry Bulb.
Heating : Indoor air temperature 70 F Dry Bulb, Outdoor air temperature 47 F Dry Bulb / 43 F Wet Bulb.
336 type: Equivalent piping length: 50 ft, Height difference: 0 ft, 360, 384, 408 type : Equivalent piping length: 75 ft, Height difference: 0 ft,
- (*2) Value for only outdoor unit
- (*3) Setting is necessary
- (*4) The amount dose not consider extra piping length. Refrigerant must be added on site in accordance with the actual piping length.
- (*5) Discharge temp. sensor / Suction temp. sensor / High-pressure sensor / Low-pressure sensor / PC board fuse
- (*6) MOCP : Maximum Overcurrent Protection(Amps)
- (*7) Permanent operation below 80% is not recommended.
- (*8) It is 54 units in case central control is in system.

System with Ducted indoor units

Model name			MMY-AP4326FT9P-UL	MMY-AP4566FT9P-UL
Outdoor unit model name			MMY-MAP1446FT9P-UL	MMY-MAP1686FT9P-UL
			MMY-MAP1446FT9P-UL	MMY-MAP1446FT9P-UL
			MMY-MAP1446FT9P-UL	MMY-MAP1446FT9P-UL
Power Supply	Nominal voltage	V/Ph/Hz	208-230 / 3 / 60	
	Voltage range	V	187Minimum / 253 Maximum	
Cooling	Nominal capacity (*1)	Btu/h	432,000	456,000
	Rated capacity (*1)	Btu/h	412,000	434,000
	Rated power consumption (*1)(*2)	kW	42.09	45.32
	Rated EER (*1)(*2)	(Btu/h)/W	9.79	9.58
Heating	Nominal capacity (*1)	Btu/h	486,000	513,000
	Rated capacity (*1)	Btu/h	462,000	488,000
	Rated power consumption (*1)(*2)	kW	41.05	43.36
	Rated COP (*1)(*2)	W/W	3.30	3.30
Weight	Unit	lbs	882 + 882 + 882	
	Packing	lbs	924 + 924 + 924	
Color			Silky shade (Munsell 1Y8.5/0.5)	
Compressor	Type		Hermetic twin rotary compressor	
	Motor output	kW	5.4 x 2 + 5.4 x 2 + 5.4 x 2	
Fan unit	Type		Propeller fan	
	Motor output	kW	1.0+1.0 + 1.0+1.0 + 1.0+1.0	
	Air volume	cfm	10850 + 10850 + 10850	
Maximum external static pressure (*3)			In.WG	
Heat exchanger			Finned tube	
Refrigerant	Name		R410A	
	Charged refrigerant amount (*4)	lbs	24.3 + 24.3 + 24.3	
High-pressure switch			psi	
Protective devices			(*5)	
Power supply wiring	MCA	A	52.1 + 52.1 + 52.1	
	MOCP (*6)	A	60 + 60 + 60	
Piping connections	Liquid	Type	Flare	
		Diameter	In	
	Suction Gas	Type	Brazing	
		Diameter	In	
	Discharge Gas	Type	Flare	
		Diameter	In	
Balance	Type	Flare		
	Diameter	In		
Indoor units	Maximum capacity of combined indoor units		50 to 150%(*7)	
	Maximum number of indoor units(*8)		64	
Sound pressure level	Cooling	dB(A)	71.5	
	Heating	dB(A)	71.5	
Operation temperature range	Cooling	*FDB	14 to 122	
	Heating	*FWB	-13 to 60	

Note

(*1) Rated conditions Cooling : Indoor air temperature 80 F Dry Bulb / 67 F Wet Bulb , Outdoor air temperature 95 F Dry Bulb.
 Heating : Indoor air temperature 70 F Dry Bulb, Outdoor air temperature 47 F Dry Bulb / 43 F Wet Bulb.
 Equivalent piping length: 75 ft, Height difference: 0 ft

(*2) Value for only outdoor unit

(*3) Setting is necessary

(*4) The amount dose not consider extra piping length. Refrigerant must be added on site in accordance with the actual piping length.

(*5) Discharge temp. sensor / Suction temp. sensor / High-pressure sensor / Low-pressure sensor / PC board fuse

(*6) MOCP : Maximum Overcurrent Protection(Amps)

(*7) Permanent operation below 80% is not recommended.

(*8) It is 54 units in case central control is in system.

System with Non-ducted indoor units

Model name			MMY-AP192S6FT9P-UL	MMY-AP240S6FT9P-UL	MMY-AP288S6FT9P-UL	MMY-AP336S6FT9P-UL
Outdoor unit model name			MMY-MAP1206FT9P-UL	MMY-MAP1206FT9P-UL	MMY-MAP1686FT9P-UL	MMY-MAP1686FT9P-UL
			MMY-MAP0726FT9P-UL	MMY-MAP1206FT9P-UL	MMY-MAP1206FT9P-UL	MMY-MAP1686FT9P-UL
Power Supply	Nominal voltage	V/Ph/Hz	208-230 / 3 / 60	208-230 / 3 / 60	208-230 / 3 / 60	208-230 / 3 / 60
	Voltage range	V	187Minimum / 253 Maximum	187Minimum / 253 Maximum	187Minimum / 253 Maximum	187Minimum / 253 Maximum
Cooling	Nominal capacity (*1)	Btu/h	192,000	240,000	288,000	336,000
	Rated capacity (*1)	Btu/h	184,000	230,000	276,000	320,000
	Rated power consumption (*1)(*2)	kW	15.19	20.81	26.99	32.44
	Rated EER (*1)(*2)	(Btu/h)/W	12.1	11.1	10.2	9.86
Heating	Nominal capacity (*1)	Btu/h	216,000	270,000	324,000	378,000
	Rated capacity (*1)	Btu/h	206,000	256,000	308,000	360,000
	Rated power consumption (*1)(*2)	kW	15.82	20.60	25.67	31.82
	Rated COP (*1)(*2)	W/W	3.82	3.64	3.52	3.32
Weight	Unit	lbs	721 + 600	721 + 721	882 + 721	882 + 882
	Packing	lbs	761 + 635	761 + 761	924 + 761	924 + 924
Color			Silky shade (Munsell 1Y8.5/0.5)	Silky shade (Munsell 1Y8.5/0.5)	Silky shade (Munsell 1Y8.5/0.5)	Silky shade (Munsell 1Y8.5/0.5)
Compressor	Type		Hermetic twin rotary compressor	Hermetic twin rotary compressor	Hermetic twin rotary compressor	Hermetic twin rotary compressor
	Motor output	kW	4.0 x 2 + 2.1 x 2	4.0 x 2 + 4.0 x 2	6.5 x 2 + 4.0 x 2	6.5 x 2 + 6.5 x 2
Fan unit	Type		Propeller fan	Propeller fan	Propeller fan	Propeller fan
	Motor output	kW	1.0 + 1.0	1.0 + 1.0	1.0+1.0 + 1.0	1.0+1.0 + 1.0+1.0
	Air volume	cfm	7700 + 5900	7700 + 7700	10850 + 7700	10850 + 10850
Maximum external static pressure (*3)			In.WG	0.16	0.16	0.16
Heat exchanger			Finned tube	Finned tube	Finned tube	Finned tube
Refrigerant	Name		R410A	R410A	R410A	R410A
	Charged refrigerant amount (*4)	lbs	24.3 + 24.3	24.3 + 24.3	24.3 + 24.3	24.3 + 24.3
High-pressure switch			psi	OFF:420 ON:540	OFF:420 ON:540	OFF:420 ON:540
Protective devices				(*5)	(*5)	(*5)
Power supply wiring	MCA	A	45.4 + 23.3	45.4 + 45.4	66.2 + 45.4	66.2 + 66.2
	MOCP (*6)	A	50 + 30	50 + 50	70 + 50	70 + 70
Piping connections	Liquid	Type	Flare	Flare	Flare	Flare
		Diameter	In	7/8"	7/8"	7/8"
	Suction Gas	Type	Brazing	Brazing	Brazing	Brazing
		Diameter	In	1-1/8"	1-3/8"	1-3/8"
	Discharge Gas	Type	Flare	Flare	Flare	Flare
		Diameter	In	7/8"	1-1/8"	1-1/8"
	Balance	Type	Flare	Flare	Flare	Flare
		Diameter	In	3/8"	3/8"	3/8"
Indoor units	Maximum capacity of combined indoor units		50 to 150%(*7)	50 to 150%(*7)	50 to 150%(*7)	50 to 150%(*7)
	Maximum number of indoor units(*8)		34	42	50	60
Sound pressure level	Cooling	dB(A)	64.0	66.0	68.5	69.5
	Heating	dB(A)	65.5	67.0	69.0	70.0
Operation temperature range	Cooling	°FDB	14 to 122	14 to 122	14 to 122	14 to 122
	Heating	°FWB	-13 to 60	-13 to 60	-13 to 60	-13 to 60

Note

(*1) Rated conditions Cooling : Indoor air temperature 80 F Dry Bulb / 67 F Wet Bulb , Outdoor air temperature 95 F Dry Bulb.
 Heating : Indoor air temperature 70 F Dry Bulb, Outdoor air temperature 47 F Dry Bulb / 43 F Wet Bulb.
 Equivalent piping length: 50 ft, Height difference: 0 ft

(*2) Value for only outdoor unit

(*3) Setting is necessary

(*4) The amount dose not consider extra piping length. Refrigerant must be added on site in accordance with the actual piping length.

(*5) Discharge temp. sensor / Suction temp. sensor / High-pressure sensor / Low-pressure sensor / PC board fuse

(*6) MOCP : Maximum Overcurrent Protection(Amps)

(*7) Permanent operation below 80% is not recommended.

(*8) It is 54 units in case central control is in system.

System with Non-ducted indoor units

Model name			MMY-MAP0726FT2P-UL	
Power Supply	Nominal voltage	V/Ph/Hz	208-230 / 1 / 60	
	Voltage range	V	187/Minimum / 253 Maximum	
Cooling	Nominal capacity (*1)	Btu/h	72,000	
	Rated capacity (*1)	Btu/h	69,000	
	Rated power consumption (*1)(*2)	kW	4.53	
	Rated EER (*1)(*2)	(Btu/h)/W	15.2	
Heating	Nominal capacity (*1)	Btu/h	81,000	
	Rated capacity (*1)	Btu/h	77,000	
	Rated power consumption (*1)(*2)	kW	5.98	
	Rated COP (*1)(*2)	W/W	3.77	
Dimension	Unit	Height	In	72.9
		Width	In	39.0
		Depth	In	30.7
	Packing	Height	In	76.3
		Width	In	41.8
		Depth	In	32.6
Weight	Unit	lbs	600	
	Packing	lbs	635	
Color			Silky shade (Munsell 1Y8.5/0.5)	
Compressor	Type		Hermetic twin rotary compressor	
	Motor output	kW	2.1 x 2	
Fan unit	Type		Propeller fan	
	Motor output	kW	1.0	
	Air volume	cfm	5900	
Maximum external static pressure (*3)			In.WG	0.24
Heat exchanger			Finned tube	
Refrigerant	Name		R410A	
	Charged refrigerant amount (*4)	lbs	24.3	
High-pressure switch			psi	OFF:420 ON:540
Protective devices			(*5)	
Power supply wiring	MCA	A	47.0	
	MOCp (*6)	A	50.0	
Piping connections	Liquid	Type	Flare	
		Diameter	In	1/2"
	Suction Gas	Type	Brazing	
		Diameter	In	7/8"
	Discharge Gas	Type	Flare	
		Diameter	In	3/4"
Balance	Type	Flare		
	Diameter	In	3/8"	
Indoor units	Maximum capacity of combined indoor units		50 to 150%(*7)	
	Maximum number of indoor units		12	
Sound pressure level	Cooling	dB(A)	57.0	
	Heating	dB(A)	60.0	
Operation temperature range	Cooling	°FDB	14 to 122	
	Heating	°FWB	-13 to 60	

Note

(*1) Rated conditions Cooling : Indoor air temperature 80 F Dry Bulb / 67 F Wet Bulb , Outdoor air temperture 95 F Dry Bulb.
 Heating : Indoor air temperature 70 F Dry Bulb, Outdoor air temperture 47 F Dry Bulb / 43 F Wet Bulb.
 Equivalent piping length : 50 ft, Height difference : 0 ft

(*2) Value for only outdoor unit

(*3) Setting is necessary

(*4) The amount dose not consider extra piping length. Refrigerant must be added on site in accordance with the actual piping length.

(*5) Discharge temp. sensor / Suction temp. sensor / High-pressure sensor / Low-pressure sensor / PC board fuse

(*6) MOCp : Maximum Overcurrent Protection(Amps)

(*7) Permanent operation below 80% is not recommended.



System with Non-ducted indoor units

Model name			MMY-AP1446FT2P-UL
Outdoor unit model name			MMY-MAP0726FT2P-UL
			MMY-MAP0726FT2P-UL
Power Supply	Nominal voltage	V/Ph/Hz	208-230 / 1 / 60
	Voltage range	V	187Minimum / 253 Maximum
Cooling	Nominal capacity (*1)	Btu/h	144,000
	Rated capacity (*1)	Btu/h	138,000
	Rated power consumption (*1)(*2)	kW	9.92
	Rated EER (*1)(*2)	(Btu/h)/W	13.9
Heating	Nominal capacity (*1)	Btu/h	162,000
	Rated capacity (*1)	Btu/h	154,000
	Rated power consumption (*1)(*2)	kW	11.69
	Rated COP (*1)(*2)	W/W	3.86
Weight	Unit	lbs	600 + 600
	Packing	lbs	635 + 635
Color			Silky shade (Munsell 1Y8.5/0.5)
Compressor	Type		Hermetic twin rotary compressor
	Motor output	kW	2.1 x 2 + 2.1 x 2
Fan unit	Type		Propeller fan
	Motor output	kW	1.0+1.0
	Air volume	cfm	5900 + 5900
Maximum external static pressure (*3)			In.WG 0.24
Heat exchanger			Finned tube
Refrigerant	Name		R410A
	Charged refrigerant amount (*4)	lbs	24.3 + 24.3
High-pressure switch			psi OFF:420 ON:540
Protective devices			(*5)
Power supply wiring	MCA	A	47.0 + 47.0
	MOCP (*6)	A	50 + 50
Piping connections	Liquid	Type	Flare
		Diameter	In 5/8"
	Suction Gas	Type	Brazing
		Diameter	In 1-1/8"
	Discharge Gas	Type	Flare
		Diameter	In 7/8"
Balance	Type	Flare	
	Diameter	In 3/8"	
Indoor units	Maximum capacity of combined indoor units		50 to 150%(*7)
	Maximum number of indoor units		25
Sound pressure level	Cooling	dB(A)	60.0
	Heating	dB(A)	63.0
Operation temperature range	Cooling	°FDB	14 to 122
	Heating	°FWB	-13 to 60

Note

(*1) Rated conditions Cooling : Indoor air temperature 80 F Dry Bulb / 67 F Wet Bulb , Outdoor air temperture 95 F Dry Bulb.
 Heating : Indoor air temperature 70 F Dry Bulb, Outdoor air temperture 47 F Dry Bulb / 43 F Wet Bulb.
 Equivalent piping length: 100 ft, Height difference: 0 ft

(*2) Value for only outdoor unit

(*3) Setting is necessary

(*4) The amount dose not consider extra piping length. Refrigerant must be added on site in accordance with the actual piping length.

(*5) Discharge temp. sensor / Suction temp. sensor / High-pressure sensor / Low-pressure sensor / PC board fuse

(*6) MOCP : Maximum Overcurrent Protection(Amps)

(*7) Permanent operation below 80% is not recommended.

System with Ducted indoor units

Model name			MMY-MAP0726FT2P-UL
Power Supply	Nominal voltage		208-230 / 1 / 60
	Voltage range		187Minimum / 253 Maximum
Cooling	Nominal capacity (*1)		Btu/h 72000
	Rated capacity (*1)		Btu/h 69000
	Rated power consumption (*1)(*2)		kW 5.11
	Rated EER (*1)(*2)		(Btu/h)/W 13.5
Heating	Nominal capacity (*1)		Btu/h 81000
	Rated capacity (*1)		Btu/h 77000
	Rated power consumption (*1)(*2)		kW 6.25
	Rated COP (*1)(*2)		W/W 3.61
Dimension	Unit	Height	In 72.9
		Width	In 39.0
		Depth	In 30.7
	Packing	Height	In 76.3
		Width	In 41.8
		Depth	In 32.6
Weight	Unit		lbs 600
	Packing		lbs 635
Color			Silky shade (Munsell 1Y8.5/0.5)
Compressor	Type		Hermetic twin rotary compressor
	Motor output	kW	2.1 x 2
Fan unit	Type		Propeller fan
	Motor output	kW	1.0
	Air volume	cfm	5900
Maximum external static pressure (*3)		In.WG	0.24
Heat exchanger			Finned tube
Refrigerant	Name		R410A
	Charged refrigerant amount (*4)		lbs 24.3
High-pressure switch		psi	OFF:420 ON:540
Protective devices			(*5)
Power supply wiring	MCA	A	47.0
	MOCP (*6)	A	50.0
Piping connections	Liquid	Type	Flare
		Diameter	In 1/2"
	Suction Gas	Type	Brazing
		Diameter	In 7/8"
	Discharge Gas	Type	Flare
		Diameter	In 3/4"
	Balance	Type	Flare
		Diameter	In 3/8"
Indoor units	Maximum capacity of combined indoor units		50 to 150%(*7)
	Maximum number of indoor units		12
Sound pressure level	Cooling	dB(A)	57.0
	Heating	dB(A)	60.0
Operation temperature range	Cooling	°FDB	14 to 122
	Heating	°FWB	-13 to 60

Note

- (*1) Rated conditions
Cooling : Indoor air temperature 80 F Dry Bulb / 67 F Wet Bulb , Outdoor air temperture 95 F Dry Bulb.
Heating : Indoor air temperature 70 F Dry Bulb, Outdoor air temperture 47 F Dry Bulb / 43 F Wet Bulb.
Equivalent piping length : 25 ft, Height difference : 0 ft
- (*2) Value for only outdoor unit
- (*3) Setting is necessary
- (*4) The amount dose not consider extra piping length. Refrigerant must be added on site in accordance with the actual piping length.
- (*5) Discharge temp. sensor / Suction temp. sensor / High-pressure sensor / Low-pressure sensor / PC board fuse
- (*6) MOCP : Maximum Overcurrent Protection(Amps)
- (*7) Permanent operation below 80% is not recommended.

System with Ducted indoor units

Model name			MMY-AP1446FT2P-UL
Outdoor unit model name			MMY-MAP0726FT2P-UL
			MMY-MAP0726FT2P-UL
Power Supply	Nominal voltage	V/Ph/Hz	208-230 / 1 / 60
	Voltage range	V	187 Minimum / 253 Maximum
Cooling	Nominal capacity (*1)	Btu/h	144,000
	Rated capacity (*1)	Btu/h	138,000
	Rated power consumption (*1)(*2)	kW	10.10
	Rated EER (*1)(*2)	(Btu/h)/W	13.7
Heating	Nominal capacity (*1)	Btu/h	162,000
	Rated capacity (*1)	Btu/h	154,000
	Rated power consumption (*1)(*2)	kW	11.82
	Rated COP (*1)(*2)	W/W	3.82
Weight	Unit	lbs	600 + 600
	Packing	lbs	635 + 635
Color			Silky shade (Munsell 1Y8.5/0.5)
Compressor	Type		Hermetic twin rotary compressor
	Motor output	kW	2.1 x 2 + 2.1 x 2
Fan unit	Type		Propeller fan
	Motor output	kW	1.0+1.0
	Air volume	cfm	5900 + 5900
Maximum external static pressure (*3)			In.WG 0.24
Heat exchanger			Finned tube
Refrigerant	Name		R410A
	Charged refrigerant amount (*4)	lbs	24.3 + 24.3
High-pressure switch			psi OFF:420 ON:540
Protective devices			(*5)
Power supply wiring	MCA	A	47.0 + 47.0
	MOCP (*6)	A	50 + 50
Piping connections	Liquid	Type	Flare
		Diameter	In 5/8"
	Suction Gas	Type	Brazing
		Diameter	In 1-1/8"
	Discharge Gas	Type	Flare
		Diameter	In 7/8"
Balance	Type	Flare	
	Diameter	In 3/8"	
Indoor units	Maximum capacity of combined indoor units		50 to 150>(*7)
	Maximum number of indoor units		25
Sound pressure level	Cooling	dB(A)	60.0
	Heating	dB(A)	63.0
Operation temperature range	Cooling	°FDB	14 to 122
	Heating	°FWB	-13 to 60

Note

(*1) Rated conditions Cooling : Indoor air temperature 80 F Dry Bulb / 67 F Wet Bulb , Outdoor air temperture 95 F Dry Bulb.
 Heating : Indoor air temperature 70 F Dry Bulb, Outdoor air temperture 47 F Dry Bulb / 43 F Wet Bulb.
 Equivalent piping length: 50 ft, Height difference: 0 ft

(*2) Value for only outdoor unit

(*3) Setting is necessary

(*4) The amount dose not consider extra piping length. Refrigerant must be added on site in accordance with the actual piping length.

(*5) Discharge temp. sensor / Suction temp. sensor / High-pressure sensor / Low-pressure sensor / PC board fuse

(*6) MOCP : Maximum Overcurrent Protection(Amps)

(*7) Permanent operation below 80% is not recommended.



5-2. Dimensional drawing

Single unit

Model : MMY-MAP0726FT6P-UL , MAP0726FT9P-UL, MAP0726FT2P-UL

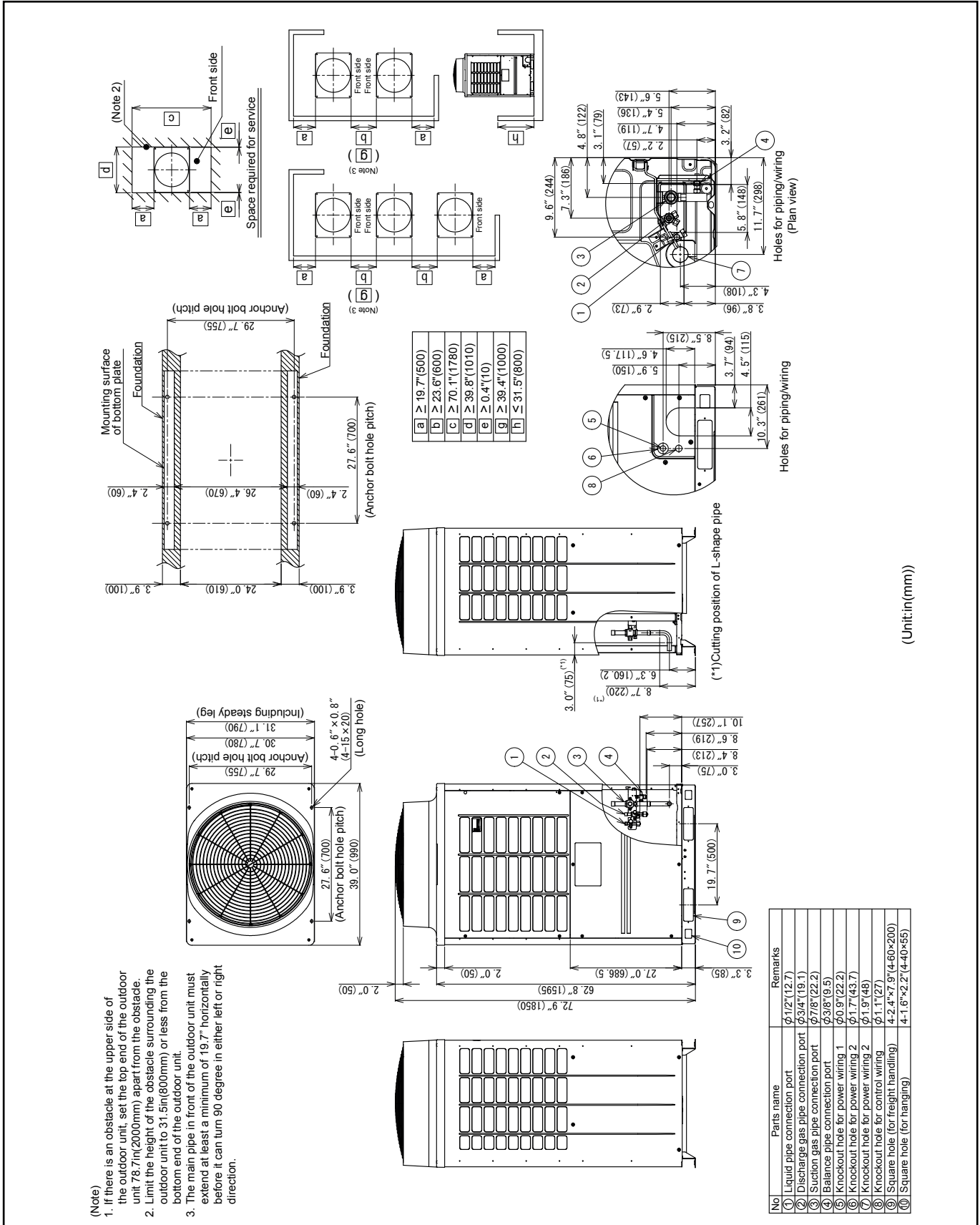

Single unit

Model : MMY-MAP0966FT6P-UL, MAP1206FT6P-UL, MAP0966FT9P-UL, MAP1206FT9P-UL

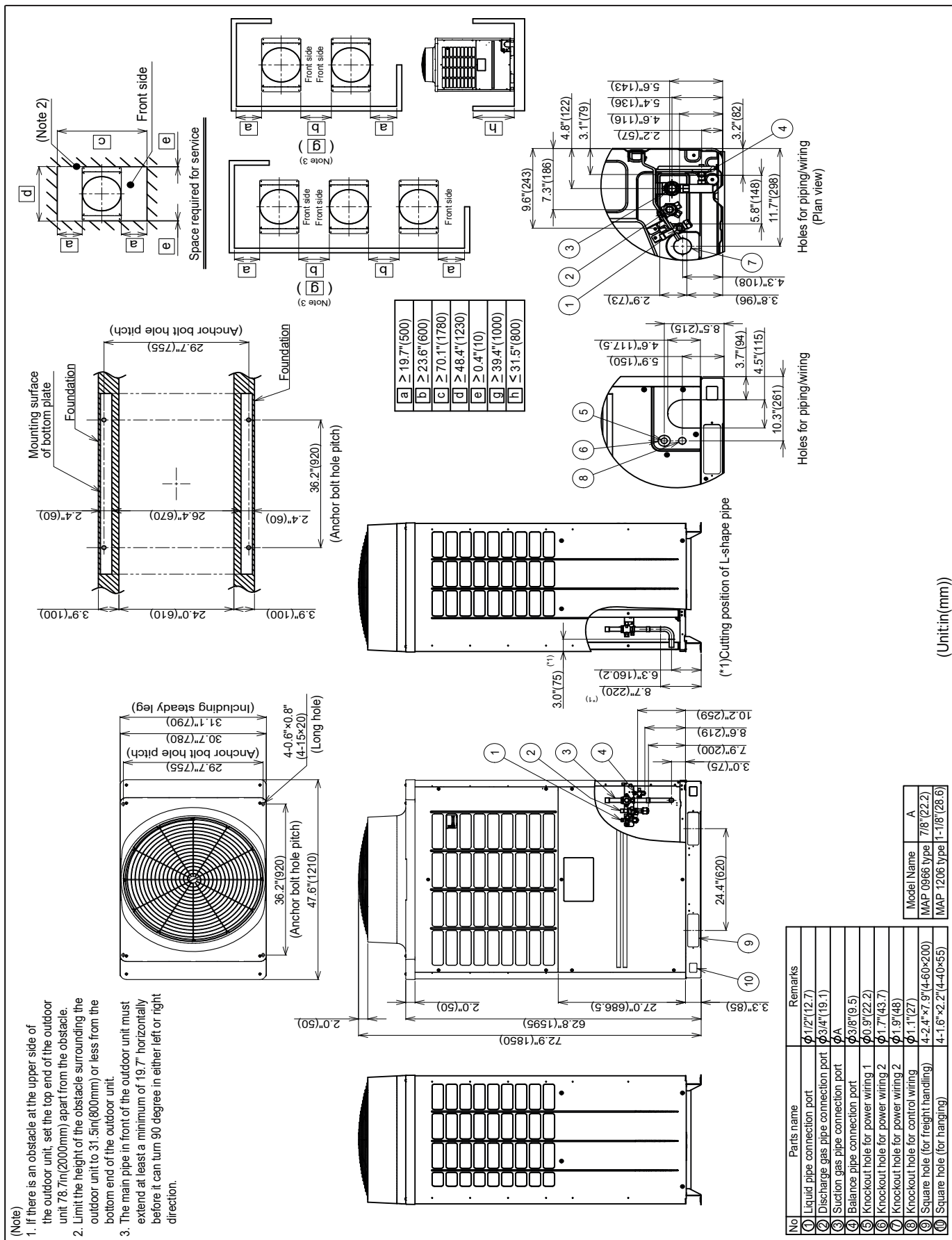

(Unit:in(mm))



Single unit

Model : MMY-MAP1446FT6P-UL, MAP1686FT6P-UL, MAP1446FT9P-UL, MAP1686FT9P-UL

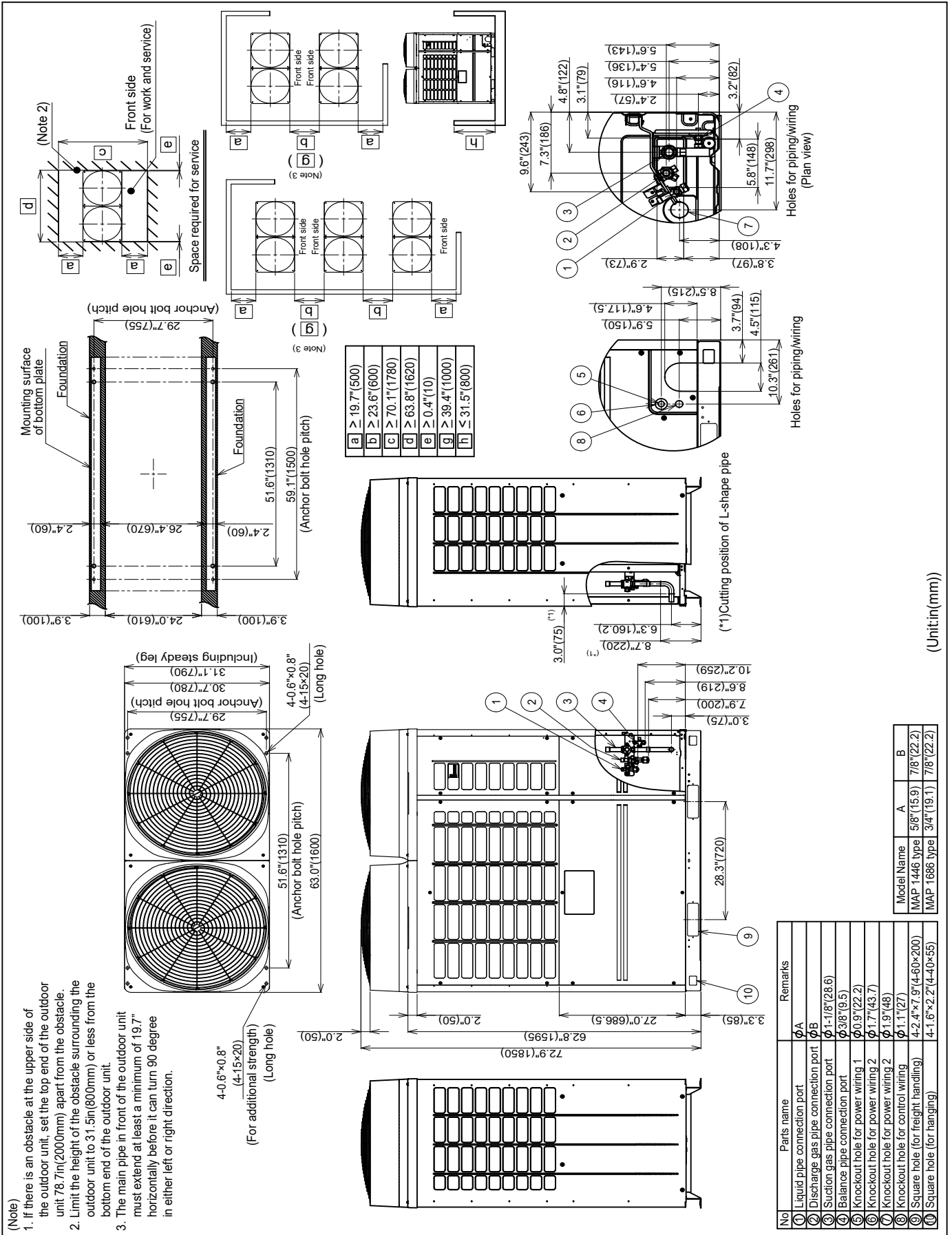

(Unit:in(mm))



Combination

Model	Outdoor unit	
	(1) Header unit	(2) Follower unit
MMY-AP1446FT2P-UL	MMY-MAP0726FT2P-UL	MMY-MAP0726FT2P-UL

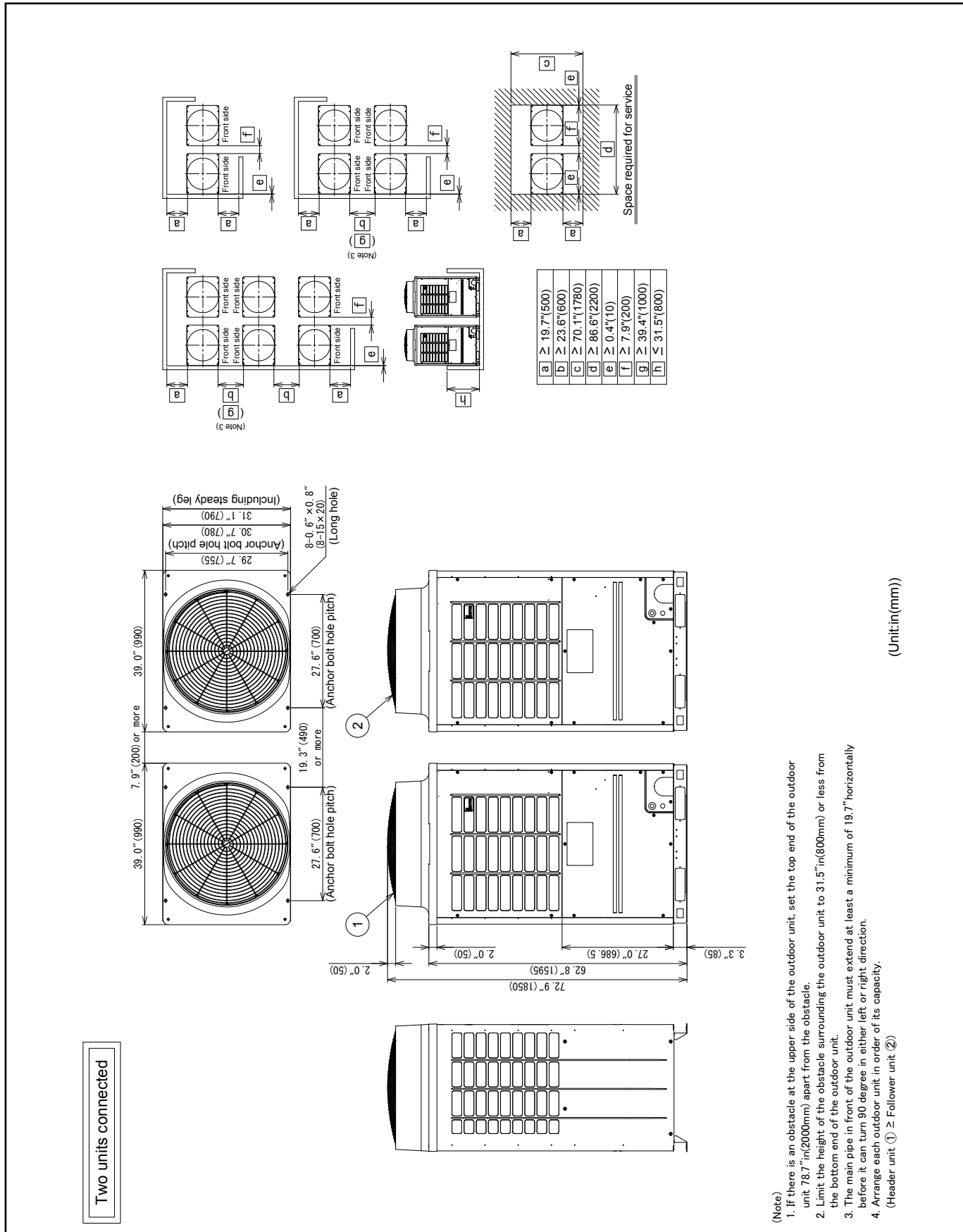

Combination

Model	Outdoor unit	
	(1) Header unit	(2) Follower unit
MMY-AP1926FT6P-UL	MMY-MAP0966FT6P-UL	MMY-MAP0966FT6P-UL
MMY-AP2166FT6P-UL	MMY-MAP1206FT6P-UL	MMY-MAP0966FT6P-UL
MMY-AP240S6FT6P-UL	MMY-MAP1206FT6P-UL	MMY-MAP1206FT6P-UL
MMY-AP1926FT9P-UL	MMY-MAP0966FT9P-UL	MMY-MAP0966FT9P-UL
MMY-AP2166FT9P-UL	MMY-MAP1206FT9P-UL	MMY-MAP0966FT9P-UL
MMY-AP240S6FT9P-UL	MMY-MAP1206FT9P-UL	MMY-MAP1206FT9P-UL

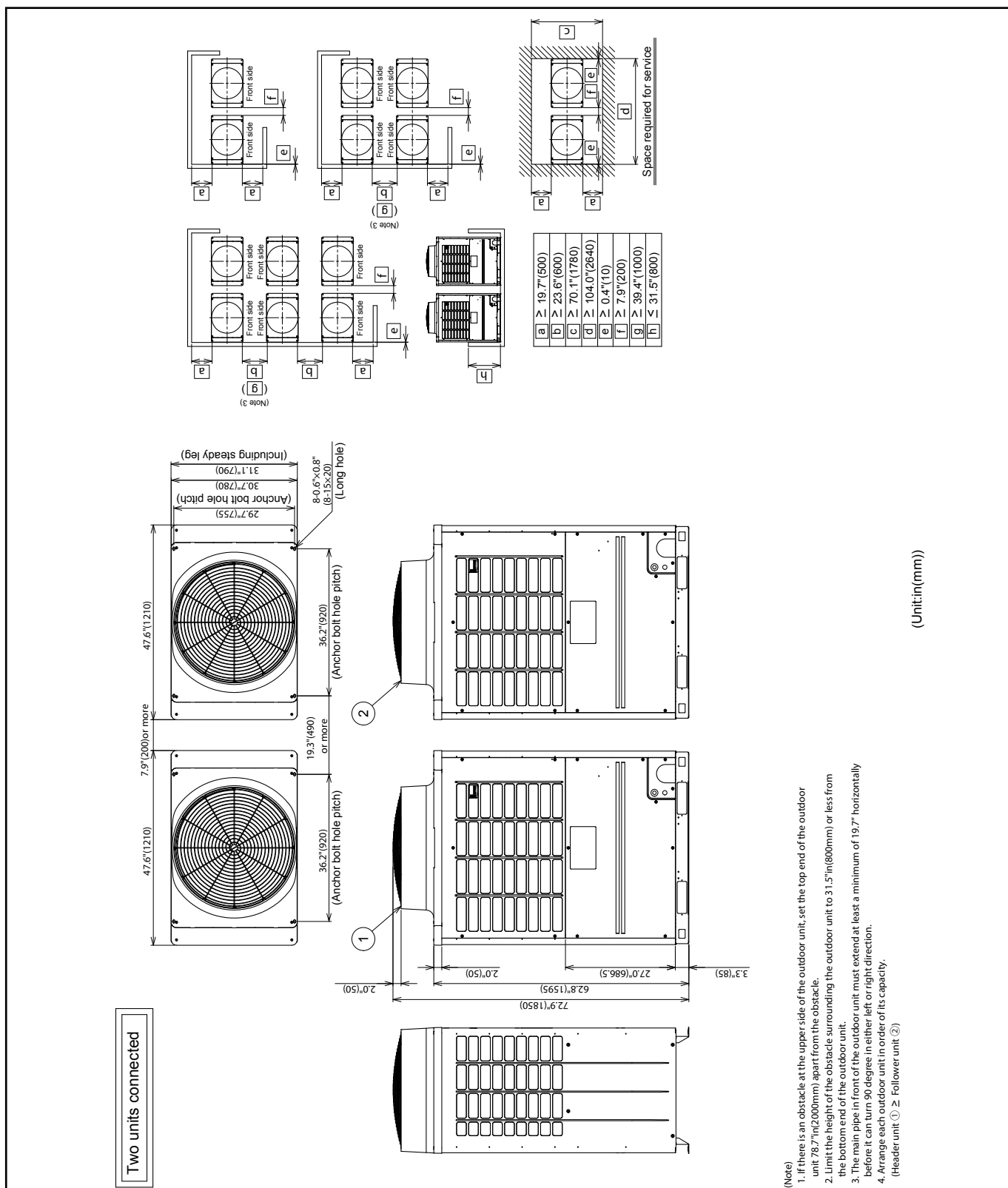



Combination

Model	Outdoor unit	
	(1) Header unit	(2) Follower unit
MMY-AP192S6FT6P-UL	MMY-MAP1206FT6P-UL	MMY-MAP0726FT6P-UL
MMY-AP192S6FT9P-UL	MMY-MAP1206FT9P-UL	MMY-MAP0726FT9P-UL

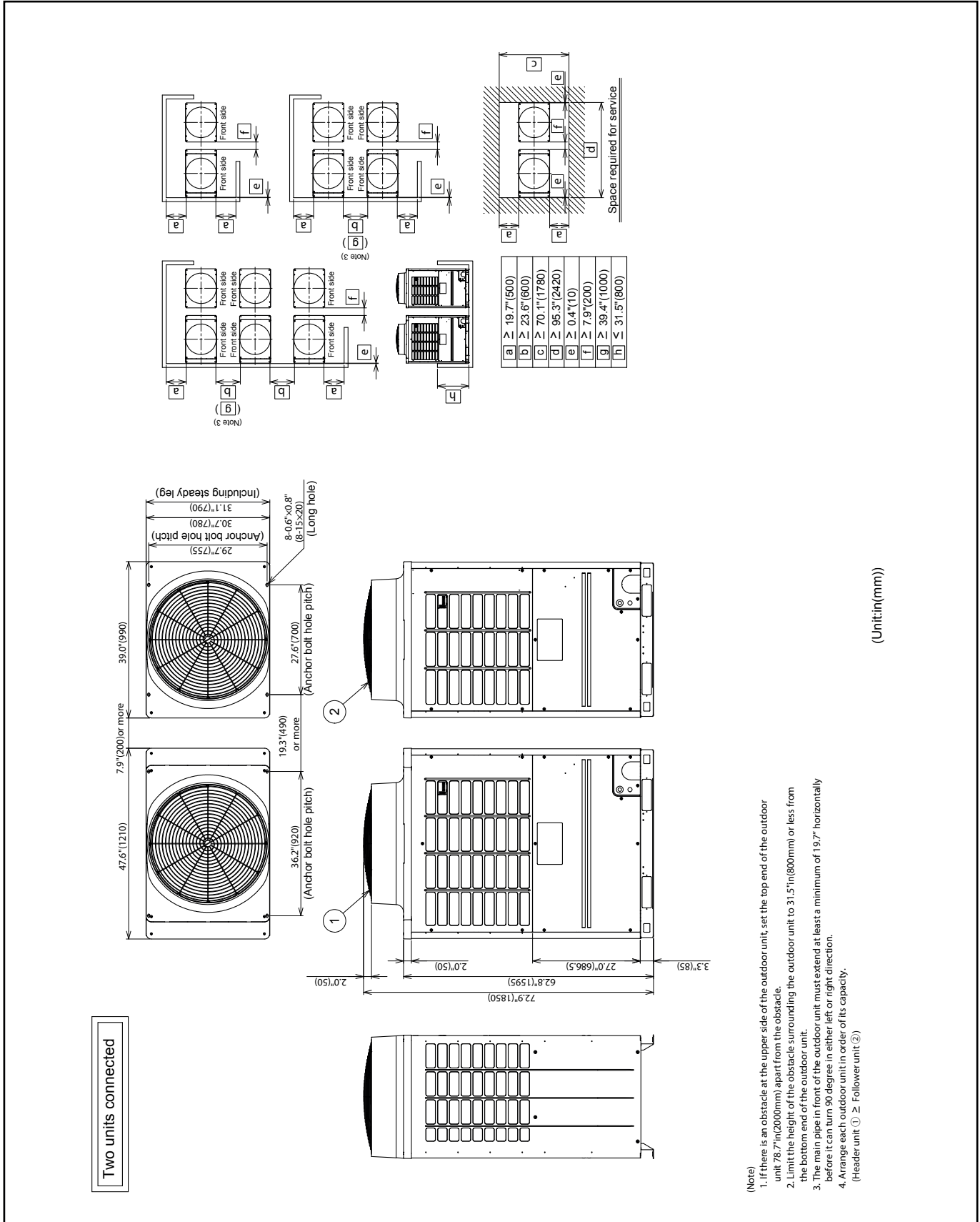

Combination

Model	Outdoor unit	
	(1) Header unit	(2) Follower unit
MMY-AP2406FT6P-UL	MMY-MAP1446FT6P-UL	MMY-MAP0966FT6P-UL
MMY-AP2646FT6P-UL	MMY-MAP1446FT6P-UL	MMY-MAP1206FT6P-UL
MMY-AP288S6F6P-UL	MMY-MAP1686FT6P-UL	MMY-MAP1206FT6P-UL
MMY-AP2406FT9P-UL	MMY-MAP1446FT9P-UL	MMY-MAP0966FT9P-UL
MMY-AP2646FT9P-UL	MMY-MAP1446FT9P-UL	MMY-MAP1206FT9P-UL
MMY-AP288S6F9P-UL	MMY-MAP1686FT9P-UL	MMY-MAP1206FT9P-UL

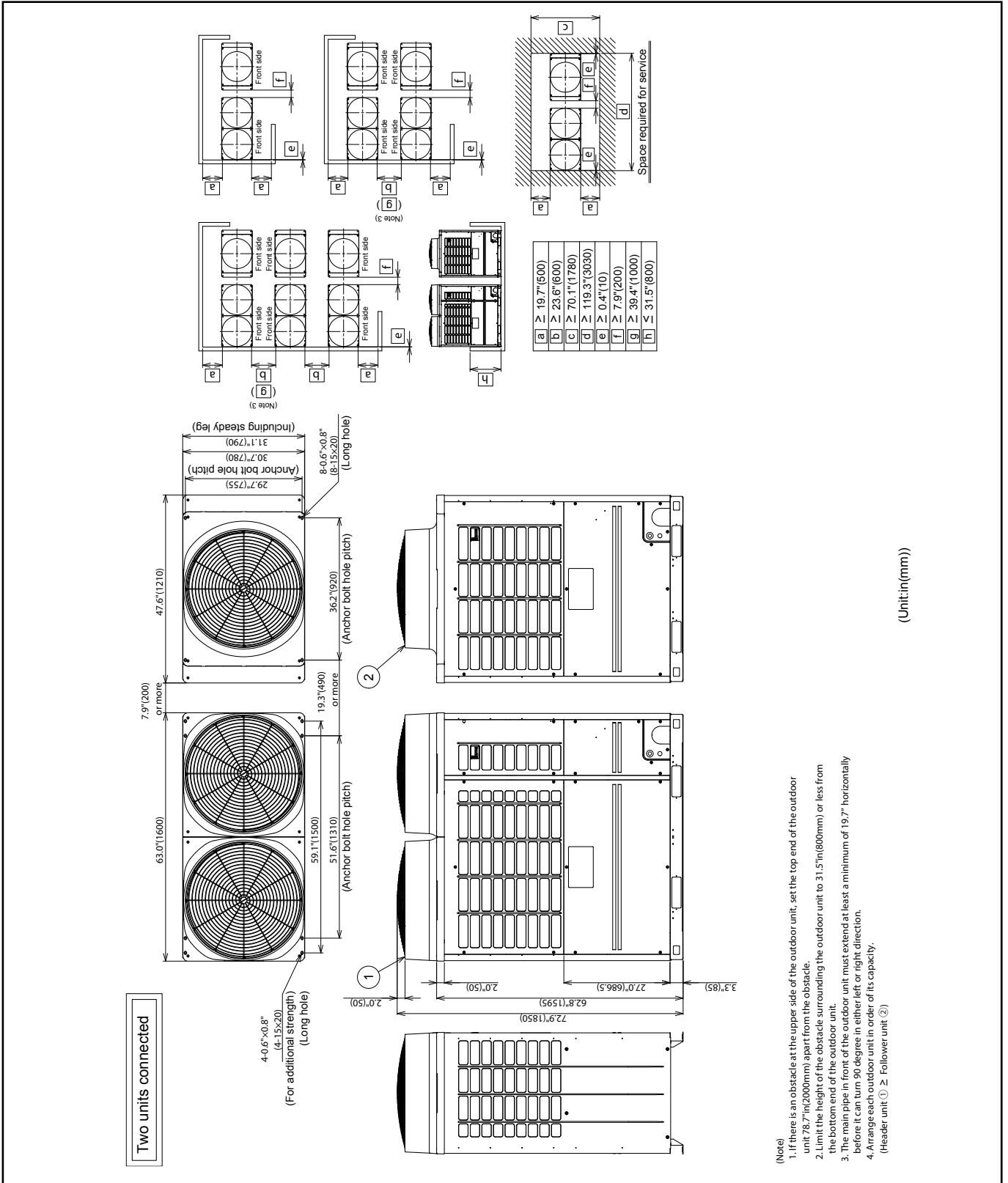

Combination

Model	Outdoor unit	
	(1) Header unit	(2) Follower unit
MMY-AP2886FT6P-UL	MMY-MAP1446FT6P-UL	MMY-MAP1446FT6P-UL
MMY-AP3126FT6P-UL	MMY-MAP1686FT6P-UL	MMY-MAP1446FT6P-UL
MMY-AP2886FT9P-UL	MMY-MAP1446FT9P-UL	MMY-MAP1446FT9P-UL
MMY-AP3126FT9P-UL	MMY-MAP1686FT9P-UL	MMY-MAP1446FT9P-UL

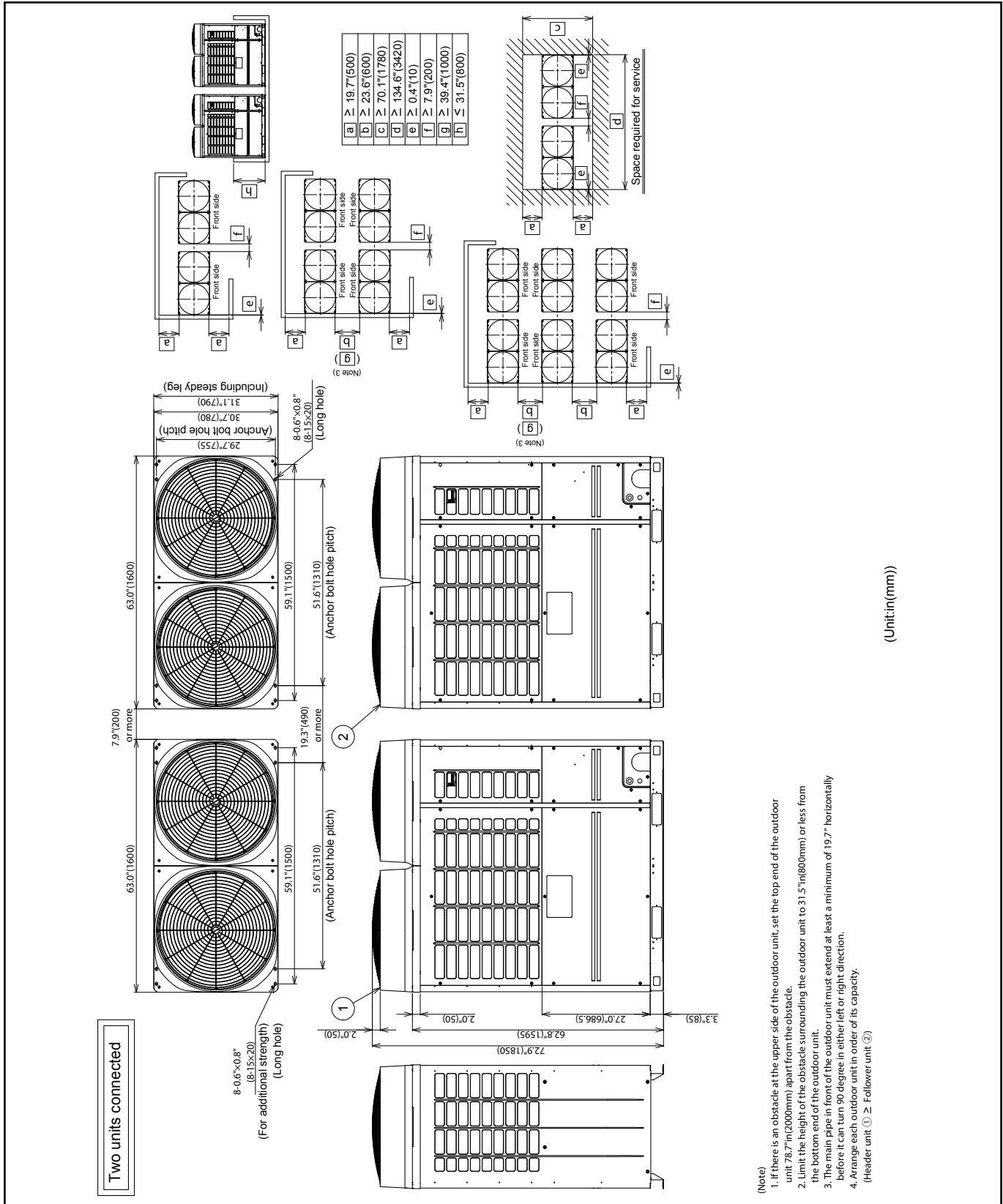



Combination

Model	Outdoor unit		
	(1) Header unit	(2) Follower unit	(3) Follower unit
MMY-AP3306FT6P-UL	MMY-MAP1206FT6P-UL	MMY-MAP1206FT6P-UL	MMY-MAP0966FT6P-UL
MMY-AP3606FT6P-UL	MMY-MAP1206FT6P-UL	MMY-MAP1206FT6P-UL	MMY-MAP1206FT6P-UL
MMY-AP3306FT9P-UL	MMY-MAP1206FT9P-UL	MMY-MAP1206FT9P-UL	MMY-MAP0966FT9P-UL
MMY-AP3606FT9P-UL	MMY-MAP1206FT9P-UL	MMY-MAP1206FT9P-UL	MMY-MAP1206FT9P-UL

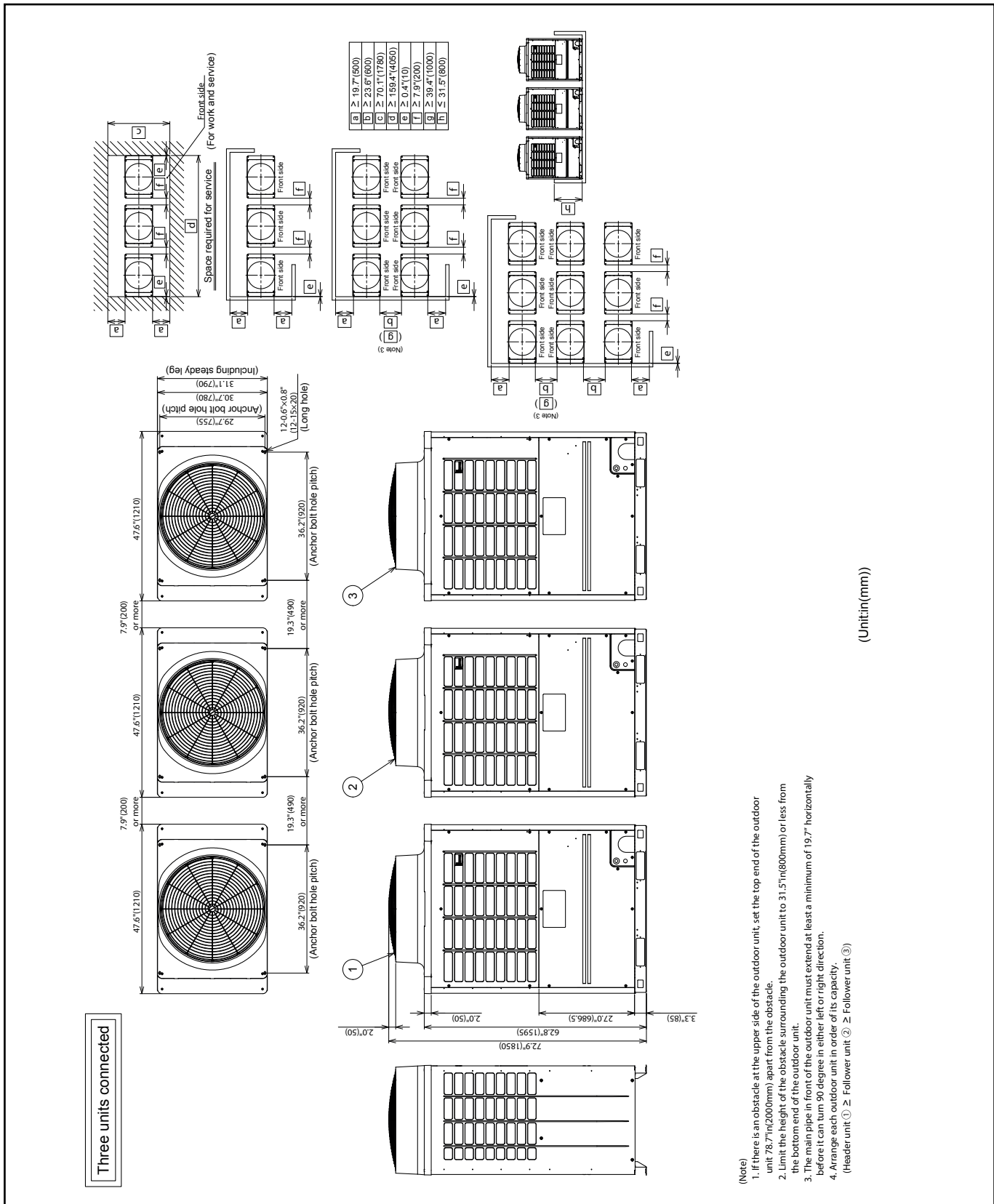

Combination

Model	Outdoor unit		
	(1) Header unit	(2) Follower unit	(3) Follower unit
MMY-AP3846FT6P-UL	MMY-MAP1446FT6P-UL	MMY-MAP1206FT6P-UL	MMY-MAP1206FT6P-UL
MMY-AP408S6FT6P-UL	MMY-MAP1686FT6P-UL	MMY-MAP1206FT6P-UL	MMY-MAP1206FT6P-UL
MMY-AP3846FT9P-UL	MMY-MAP1446FT9P-UL	MMY-MAP1206FT9P-UL	MMY-MAP1206FT9P-UL
MMY-AP408S6FT9P-UL	MMY-MAP1686FT9P-UL	MMY-MAP1206FT9P-UL	MMY-MAP1206FT9P-UL

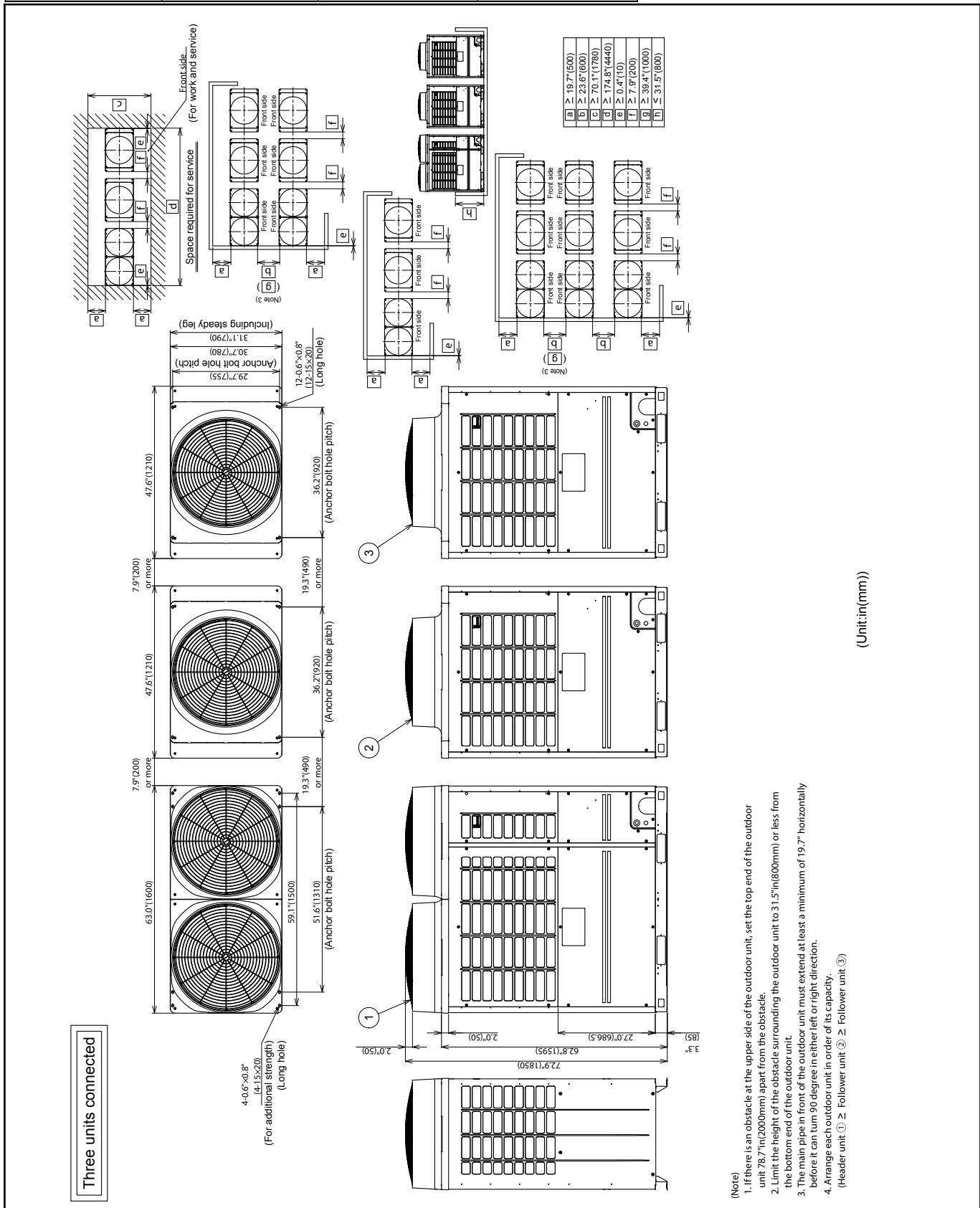

(Note)

1. If there is an obstacle at the upper side of the outdoor unit, set the top end of the outdoor unit 78.7" (2000mm) apart from the obstacle.
2. Limit the height of the obstacle surrounding the outdoor unit to 31.5" (800mm) or less from the bottom end of the outdoor unit.
3. The main pipe in front of the outdoor unit must extend at least a minimum of 19.7" horizontally before it can turn 90 degree in either left or right direction.
4. Arrange each outdoor unit in order of its capacity.
(Header unit ① ≥ Follower unit ② ≥ Follower unit ③)

(Unit:in(mm))



Combination

Model	Outdoor unit		
	(1) Header unit	(2) Follower unit	(3) Follower unit
MMY-AP4086FT6P-UL	MMY-MAP1446FT6P-UL	MMY-MAP1446FT6P-UL	MMY-MAP1206FT6P-UL
MMY-AP4086FT9P-UL	MMY-MAP1446FT9P-UL	MMY-MAP1446FT9P-UL	MMY-MAP1206FT9P-UL

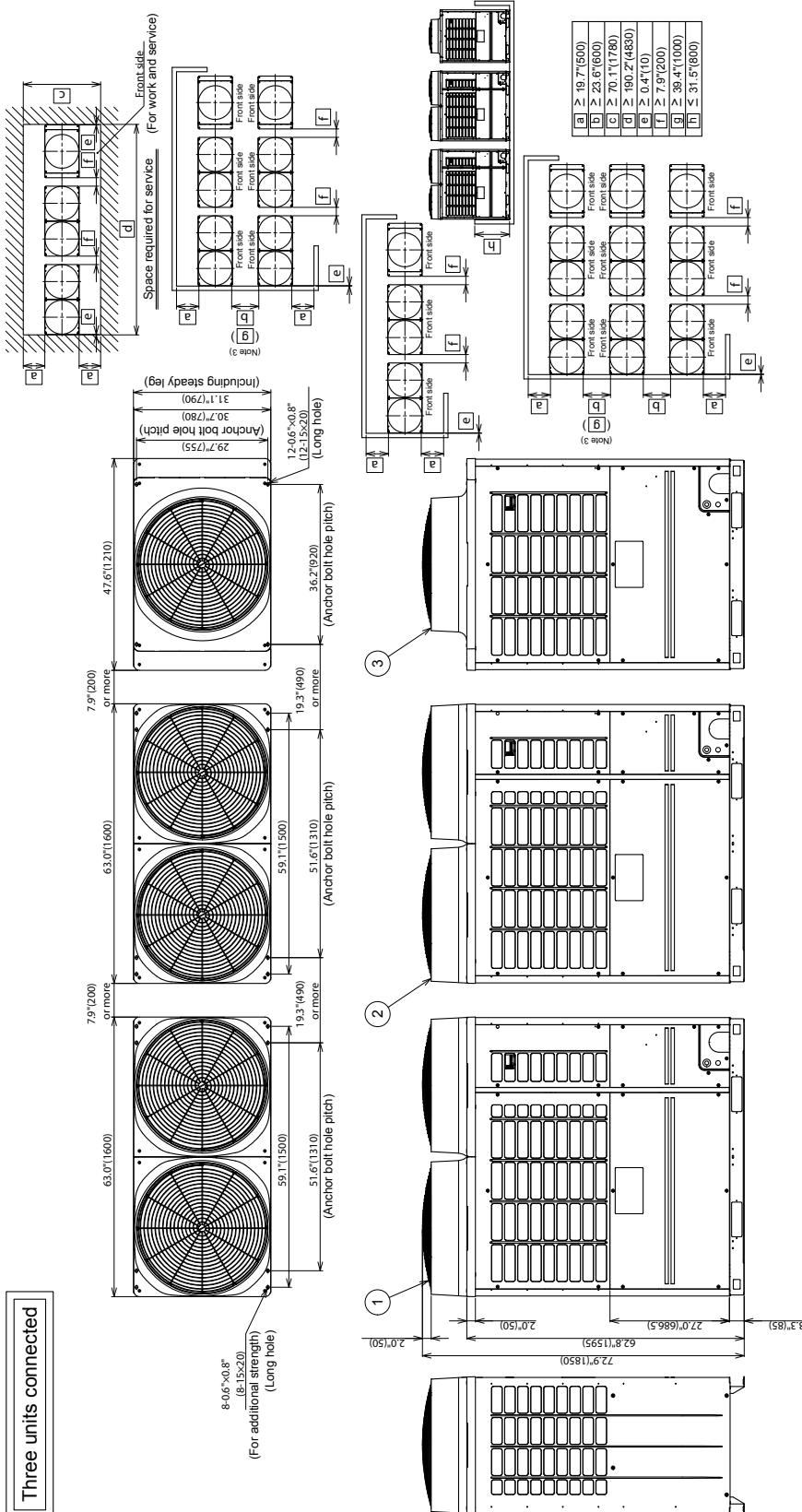

Three units connected

- (Note)
1. If there is an obstacle at the upper side of the outdoor unit, set the top end of the outdoor unit 78.7" (2000mm) apart from the obstacle.
 2. Limit the height of the obstacle surrounding the outdoor unit to 31.5" (800mm) or less from the bottom end of the outdoor unit.
 3. The main pipe in front of the outdoor unit must extend at least a minimum of 19.7" horizontally before it can turn 90 degree in either left or right direction.
 4. Arrange each outdoor unit in order of its capacity.
- (Header unit ① ≥ Follower unit ② ≥ Follower unit ③)

(Unit:in(mm))

Combination

Model	Outdoor unit		
	(1) Header unit	(2) Follower unit	(3) Follower unit
MMY-AP4326FT6P-UL	MMY-MAP1446FT6P-UL	MMY-MAP1446FT6P-UL	MMY-MAP1446FT6P-UL
MMY-AP4566FT6P-UL	MMY-MAP1686FT6P-UL	MMY-MAP1446FT6P-UL	MMY-MAP1446FT6P-UL
MMY-AP4326FT9P-UL	MMY-MAP1446FT9P-UL	MMY-MAP1446FT9P-UL	MMY-MAP1446FT9P-UL
MMY-AP4566FT9P-UL	MMY-MAP1686FT9P-UL	MMY-MAP1446FT9P-UL	MMY-MAP1446FT9P-UL

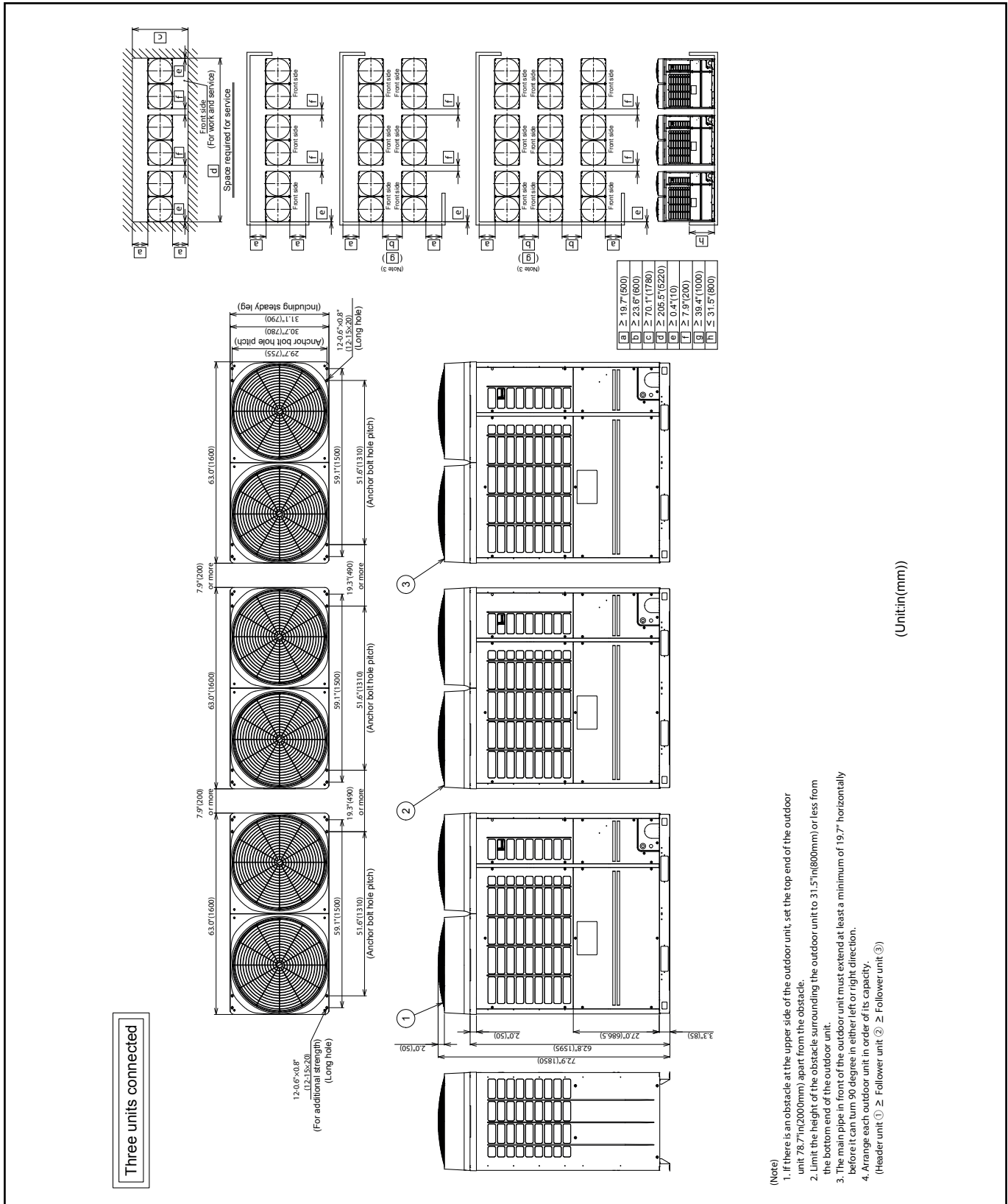

5.3 Center of gravity

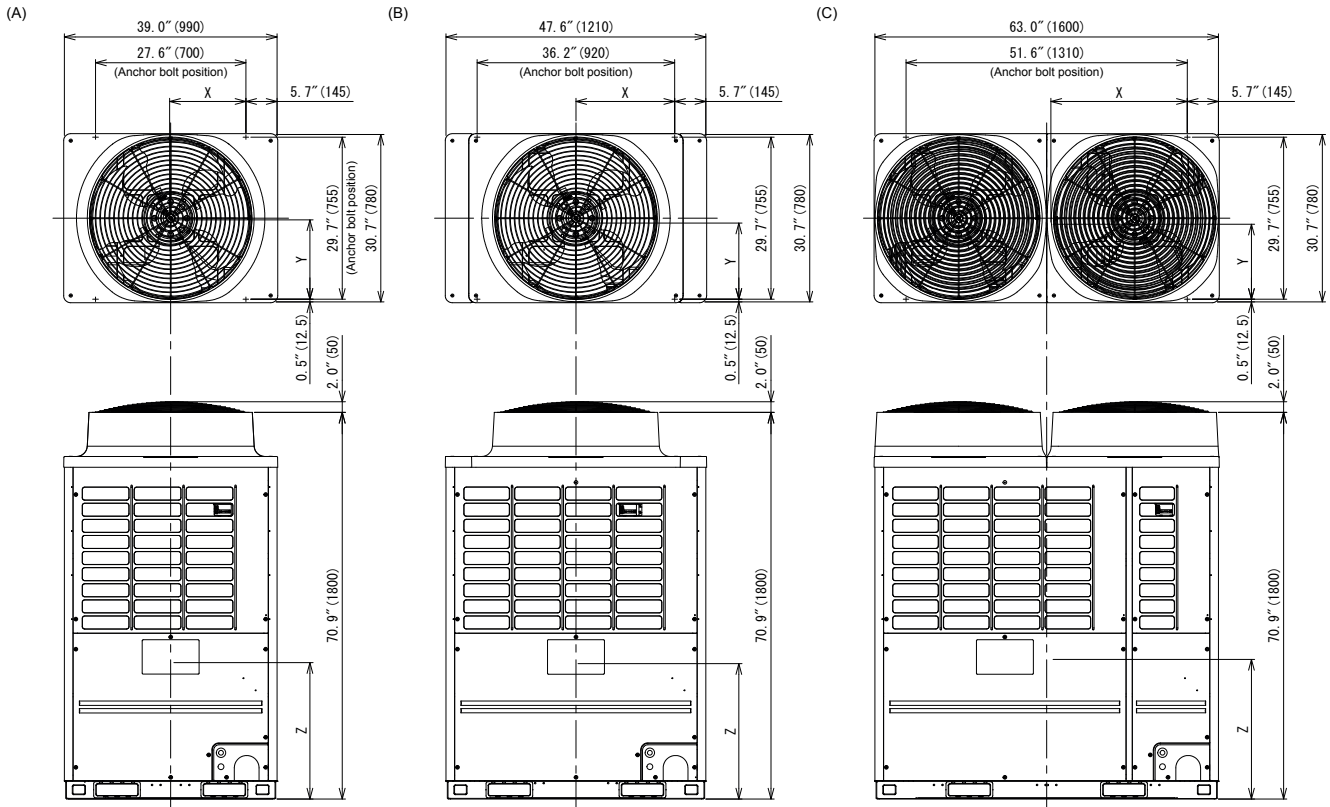

	Model type	X (In(mm))	Y (In(mm))	Z (In(mm))	Weight (lbs(kg))
(A)	MAP0726FT6P/9P/2P-UL	15.2"(385)	14.7"(373)	24.0"(610)	615(279) / 600(272)
(B)	MAP0966FT6P/9P-UL	18.5"(470)	15.1"(383)	23.2"(590)	736(334) / 721(327)
	MAP1206FT6P/9P-UL				
(C)	MAP1446FT6P/9P-UL	25.0"(635)	15.7"(398)	22.4"(570)	875(397) / 882(400)
	MAP1686FT6P/9P-UL				

5-4. Branch header / branch joint

• Branch header

RBM-HY1043FUL, HY1083FUL, HY2043FUL, HY2083FUL

Suction gas side

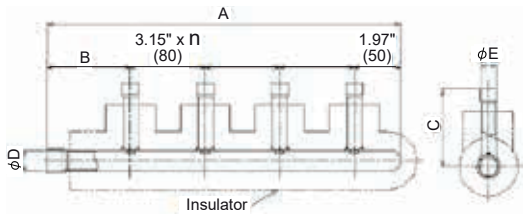

Discharge gas side

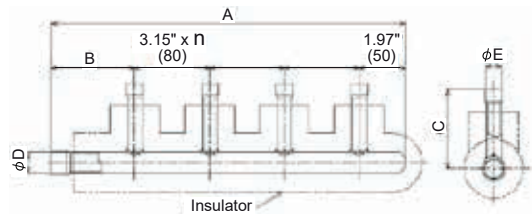

Liquid side

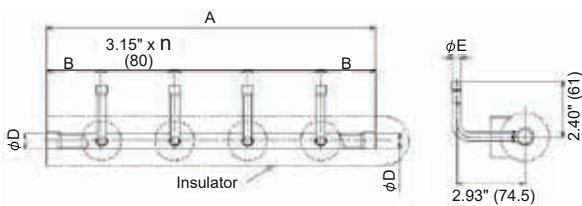

Unit: in (mm)

Model		A	B	C	ϕD	ϕE	n	Accessory socket Qty
RBM-HY1043FUL	Suction gas side	15.0" (380)	3.54" (90)	3.29" (83.6)	7/8" (22.2)	5/8" (15.9)	3	⑥ × 3, ⑨ × 4, ⑭ × 1, ⑰ × 1
	Discharge gas side	15.0" (380)	3.54" (90)	3.29" (83.6)	7/8" (22.2)	5/8" (15.9)	3	⑥ × 4, ⑨ × 4, ⑰ × 1, ⑳ × 1
	Liquid side	13.0" (330)	1.77" (45)	—	5/8" (15.9)	3/8" (9.5)	3	① × 4, ⑥ × 1, ⑨ × 1
RBM-HY1083FUL	Suction gas side	27.6" (700)	3.54" (90)	3.29" (83.6)	7/8" (22.2)	5/8" (15.9)	7	⑥ × 7, ⑨ × 8, ⑭ × 1, ⑰ × 1
	Discharge gas side	27.6" (700)	3.54" (90)	3.29" (83.6)	7/8" (22.2)	5/8" (15.9)	7	⑥ × 8, ⑨ × 8, ⑰ × 1, ⑳ × 1
	Liquid side	25.6" (650)	1.77" (45)	—	5/8" (15.9)	3/8" (9.5)	7	① × 8, ⑥ × 1, ⑨ × 1
RBM-HY2043FUL	Suction gas side	15.2" (385.5)	3.76" (95.5)	3.52" (89.3)	1-1/4" (31.8)	5/8" (15.9)	3	⑥ × 2, ⑨ × 2, ⑳ × 1, ㉑ × 1
	Discharge gas side	15.0" (380)	3.54" (90)	3.29" (83.6)	7/8" (22.2)	5/8" (15.9)	3	⑨ × 4, ⑰ × 1
	Liquid side	13.0" (330)	1.77" (45)	—	5/8" (15.9)	3/8" (9.5)	3	① × 2, ⑤ × 1
RBM-HY2083FUL	Suction gas side	27.8" (705.5)	3.76" (95.5)	3.52" (89.3)	1-1/4" (31.8)	5/8" (15.9)	7	⑥ × 7, ⑨ × 7, ⑳ × 1, ㉑ × 1
	Discharge gas side	27.6" (700)	3.54" (90)	3.29" (83.6)	7/8" (22.2)	5/8" (15.9)	7	⑨ × 8, ⑰ × 1
	Liquid side	25.6" (650)	1.77" (45)	—	5/8" (15.9)	3/8" (9.5)	7	① × 7, ⑤ × 1

• Y-shape branch joint

RBM-BY55FUL, BY105FUL, BY205FUL, BY305FUL

Suction gas side

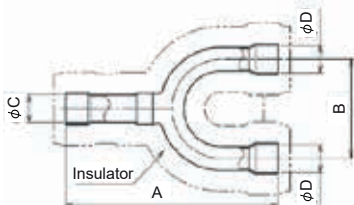

Discharge gas side

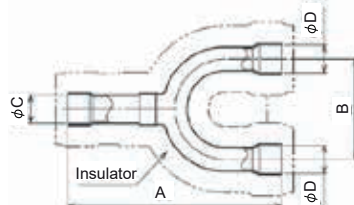

Liquid side

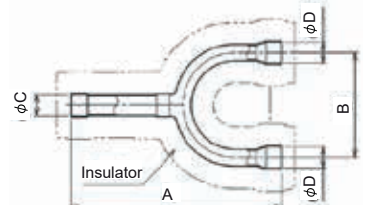

Unit: in (mm)

Model		A	B	ϕC	ϕD	Accessory socket Qty
RBM-BY55FUL	Suction gas side	6.30" (160)	3.15" (80)	5/8" (15.9)	5/8" (15.9)	⑨ × 2
	Discharge gas side	6.30" (160)	3.15" (80)	5/8" (15.9)	5/8" (15.9)	⑨ × 3
	Liquid side	5.12" (130)	2.76" (70)	3/8" (9.5)	3/8" (9.5)	① × 2
RBM-BY105FUL	Suction gas side	6.69" (170)	3.15" (80)	7/8" (22.2)	7/8" (22.2)	⑭ × 2, ⑰ × 2, ⑲ × 1
	Discharge gas side	6.69" (170)	3.15" (80)	7/8" (22.2)	7/8" (22.2)	⑰ × 1, ⑳ × 2
	Liquid side	6.30" (160)	3.15" (80)	5/8" (15.9)	5/8" (15.9)	⑨ × 1, ⑲ × 1, ㉑ × 1
RBM-BY205FUL	Suction gas side	7.87" (200)	3.15" (80)	1-1/4" (31.8)	1-1/8" (28.6)	⑰ × 1, ⑳ × 1, ㉑ × 2, ㉒ × 1, ㉓ × 1, ㉔ × 1
	Discharge gas side	6.69" (170)	3.15" (80)	7/8" (22.2)	7/8" (22.2)	⑰ × 2, ⑰ × 2, ⑳ × 1
	Liquid side	6.30" (160)	3.15" (80)	5/8" (15.9)	5/8" (15.9)	⑨ × 1, ⑲ × 1, ㉑ × 1
RBM-BY305FUL	Suction gas side	8.66" (220)	3.15" (80)	1-1/2" (38.1)	1-1/2" (38.1)	⑳ × 1, ㉑ × 3, ㉒ × 2, ㉓ × 2, ㉔ × 1, ㉕ × 1, ㉖ × 1
	Discharge gas side	8.66" (220)	3.15" (80)	1-1/2" (38.1)	1-1/2" (38.1)	㉓ × 1, ㉔ × 2, ㉕ × 1, ㉖ × 1, ㉗ × 1
	Liquid side	6.69" (170)	3.15" (80)	7/8" (22.2)	7/8" (22.2)	⑭ × 1, ⑰ × 1, ⑲ × 1, ㉑ × 1

- Branching joint for connection of outdoor units
RBM-BT14FUL

Suction gas side

Unit: in (mm)

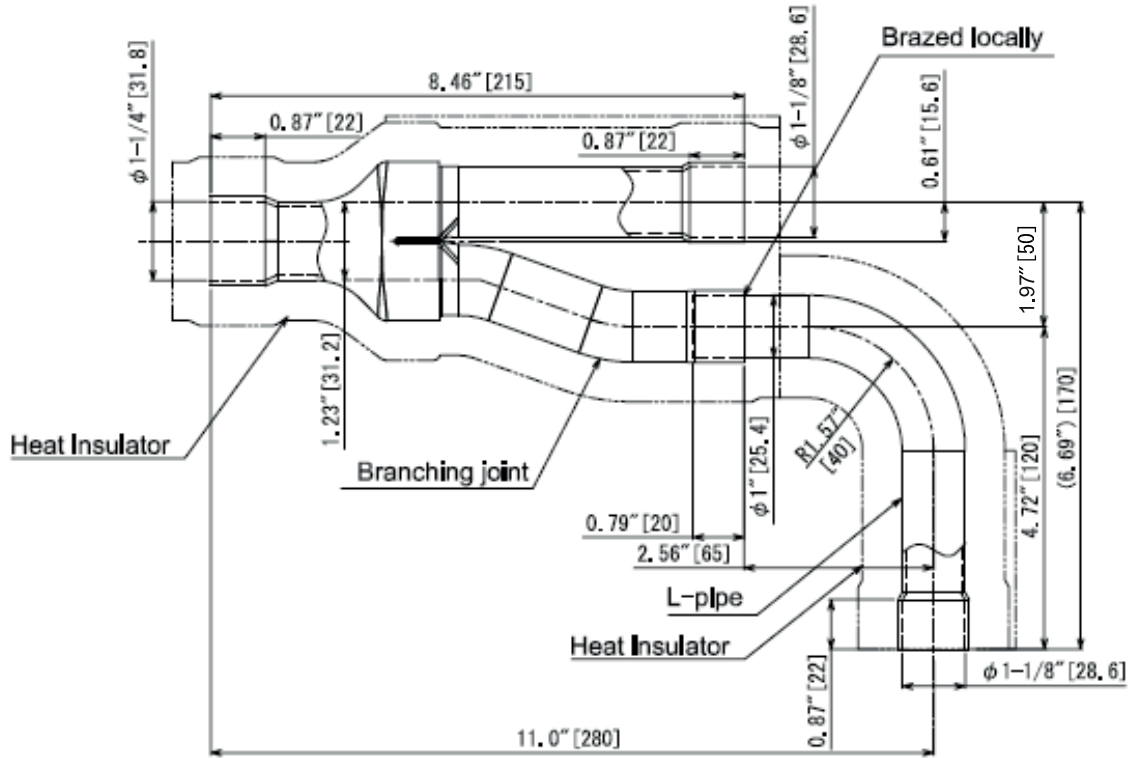

Discharge gas side

Liquid side

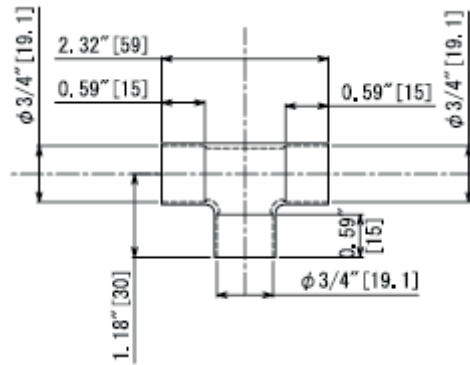
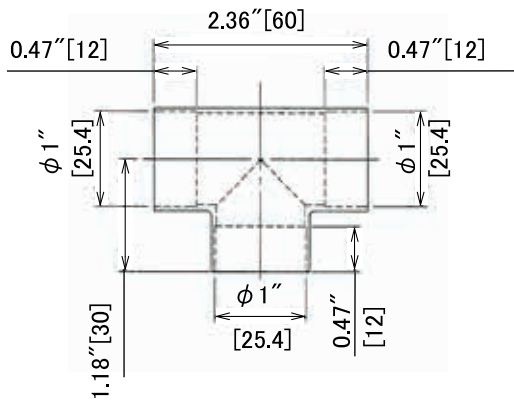

Model	Accessory socket Qty
RBM-BT14FUL	Suction gas side ⑦ x 1, ④ x 2, ⑨ x 1
	Discharge gas side ⑱ x 2, ② x 1, ⑧ x 1
	Liquid side ⑩ x 2, ⑬ x 1

RBM-BT24FUL

Unit: in (mm)

Suction gas side

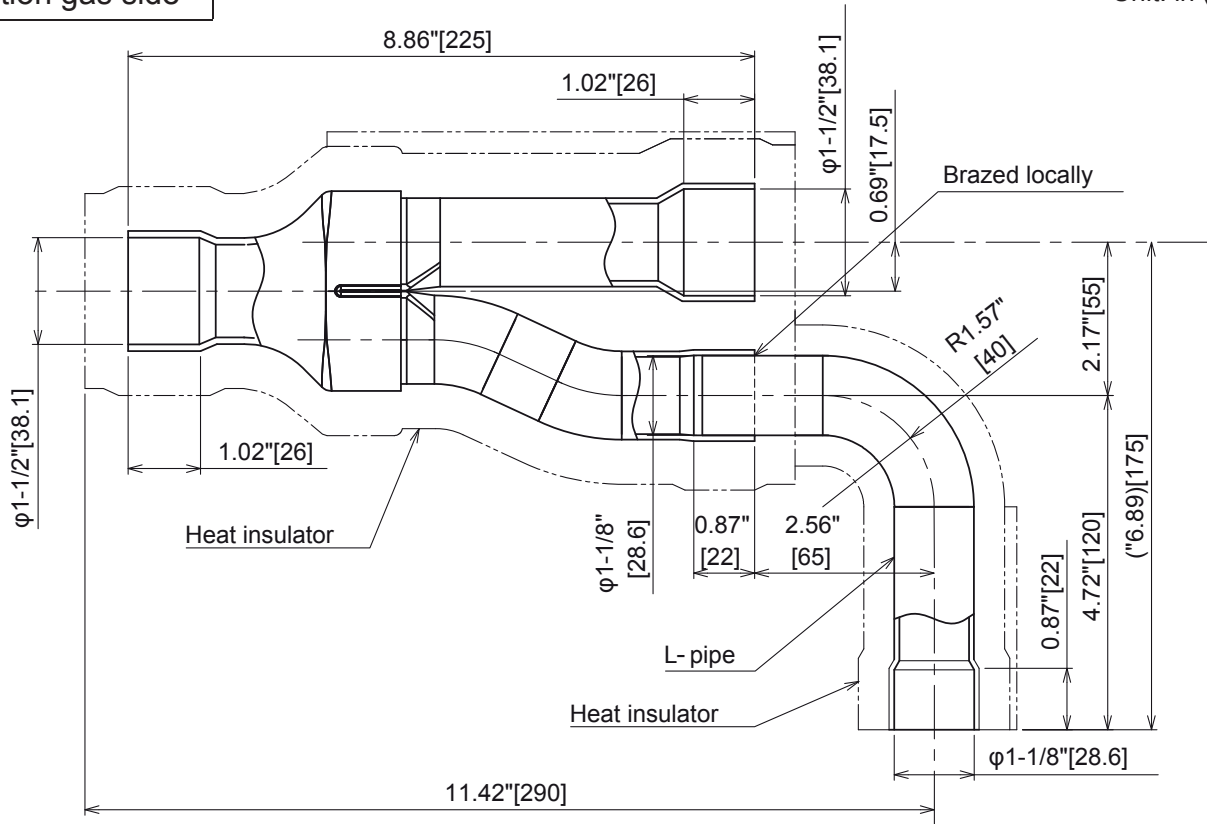

Discharge gas side

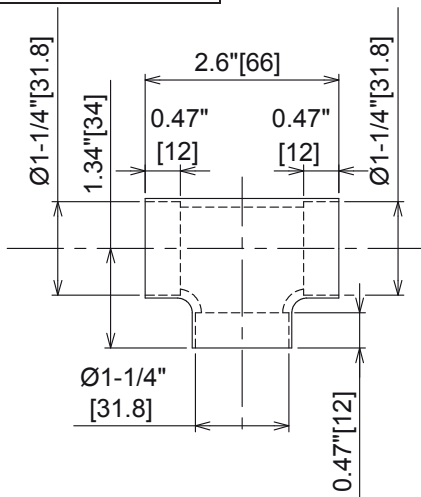

Liquid side

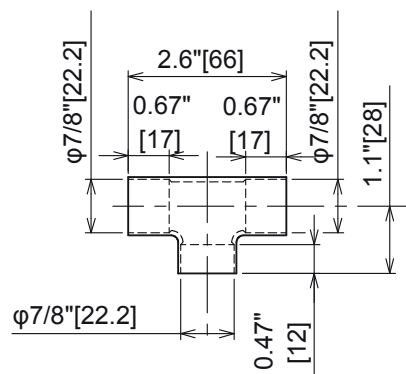

Balance pipe side

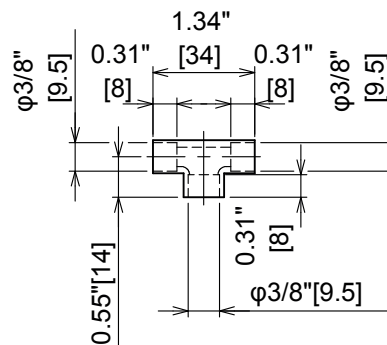

Model	Accessory socket Qty
RBM-BT24FUL	Suction gas side ④ × 1, ⑥ × 2, ⑥ × 1, ⑦ × 1
	Discharge gas side ② × 1, ③ × 2, ⑦ × 2, ⑧ × 1
	Liquid side ⑭ × 2, ⑮ × 2, ⑯ × 1

• Accessory socket

Unit:in(mm)

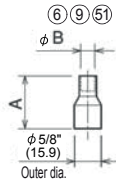
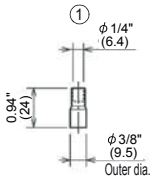

	A	φB
⑥	1.26" (32)	3/8" (9.5)
⑨	1.10" (28)	1/2" (12.7)
⑤①	1.48" (37.5)	3/4" (19.1)

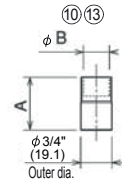

	A	φB
⑩	1.42" (36)	1/2" (12.7)
⑬	1.30" (33)	5/8" (15.9)

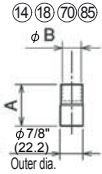

	A	φB
⑭	1.57" (40)	5/8" (15.9)
⑱	1.57" (40)	3/4" (19.1)
⑦①	2.13" (54)	1-1/8" (28.6)
⑧⑤	1.61" (41)	1/2" (12.7)

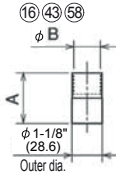

	A	φB
⑯	1.97" (50)	5/8" (15.9)
④③	1.97" (50)	7/8" (22.2)
⑤⑧	2.44" (62)	1-3/8" (34.9)

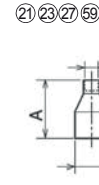

	A	B
⑳	2.17" (55)	3/4" (19.1)
㉓	2.17" (55)	7/8" (22.2)
㉗	1.93" (49)	1-1/8" (28.6)
⑤⑨	2.32" (59)	1-3/8" (34.9)

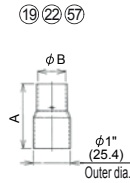
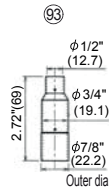
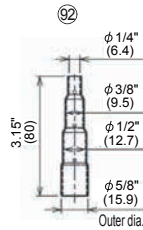
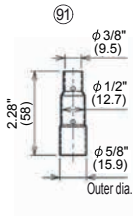

	A	φB
⑲	1.81" (46)	3/4" (19.1)
㉒	1.73" (44)	7/8" (22.2)
⑤⑦	2.05" (52)	1-1/8" (28.6)

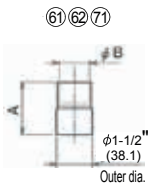

	A	φB
⑥①	2.17" (55)	1-3/8" (34.9)
⑥②	2.6" (66)	1-5/8" (41.3)
⑦①	2.6" (66)	1-1/8" (28.6)

Sealed pipe

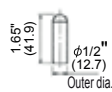
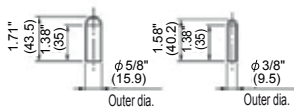

5-5. Refrigerant cycle diagram

Model : MMY-MAP0726FT**-UL

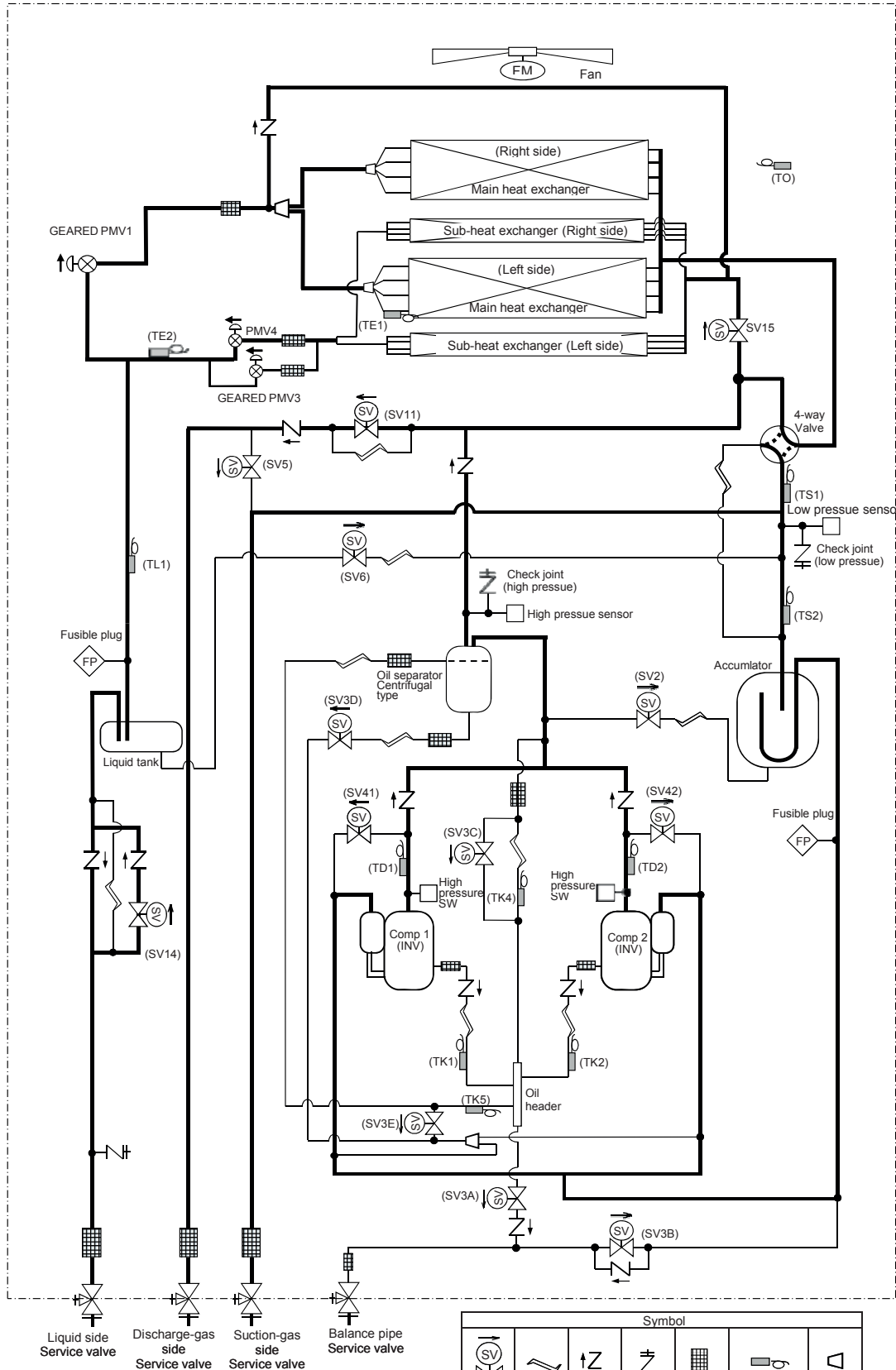

Model : MMY-MAP0966FT**-UL , MMY-MAP1206FT**-UL

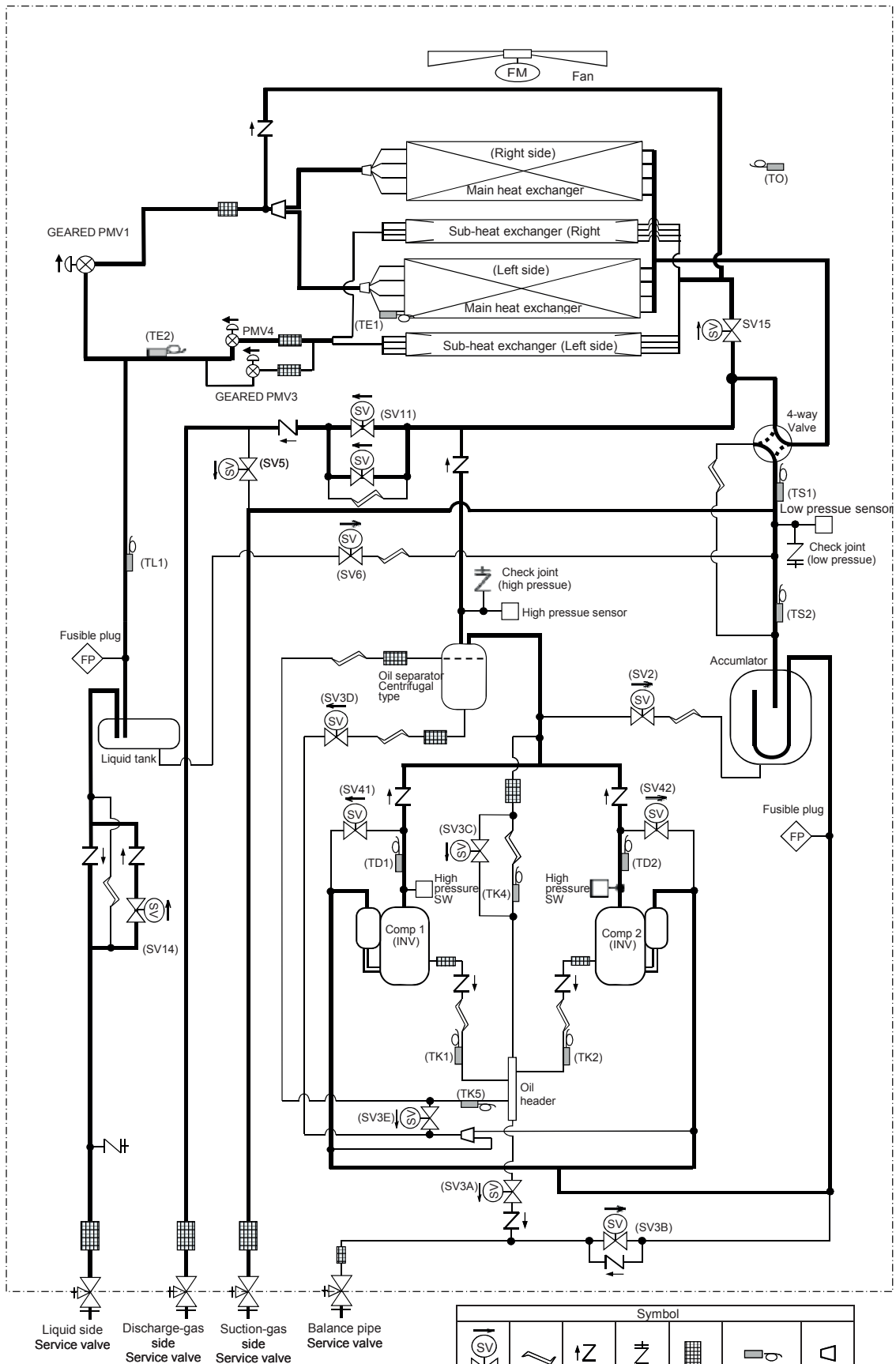

Model : MMY-MAP1446FT**-UL, MMY-MAP1686FT**-UL

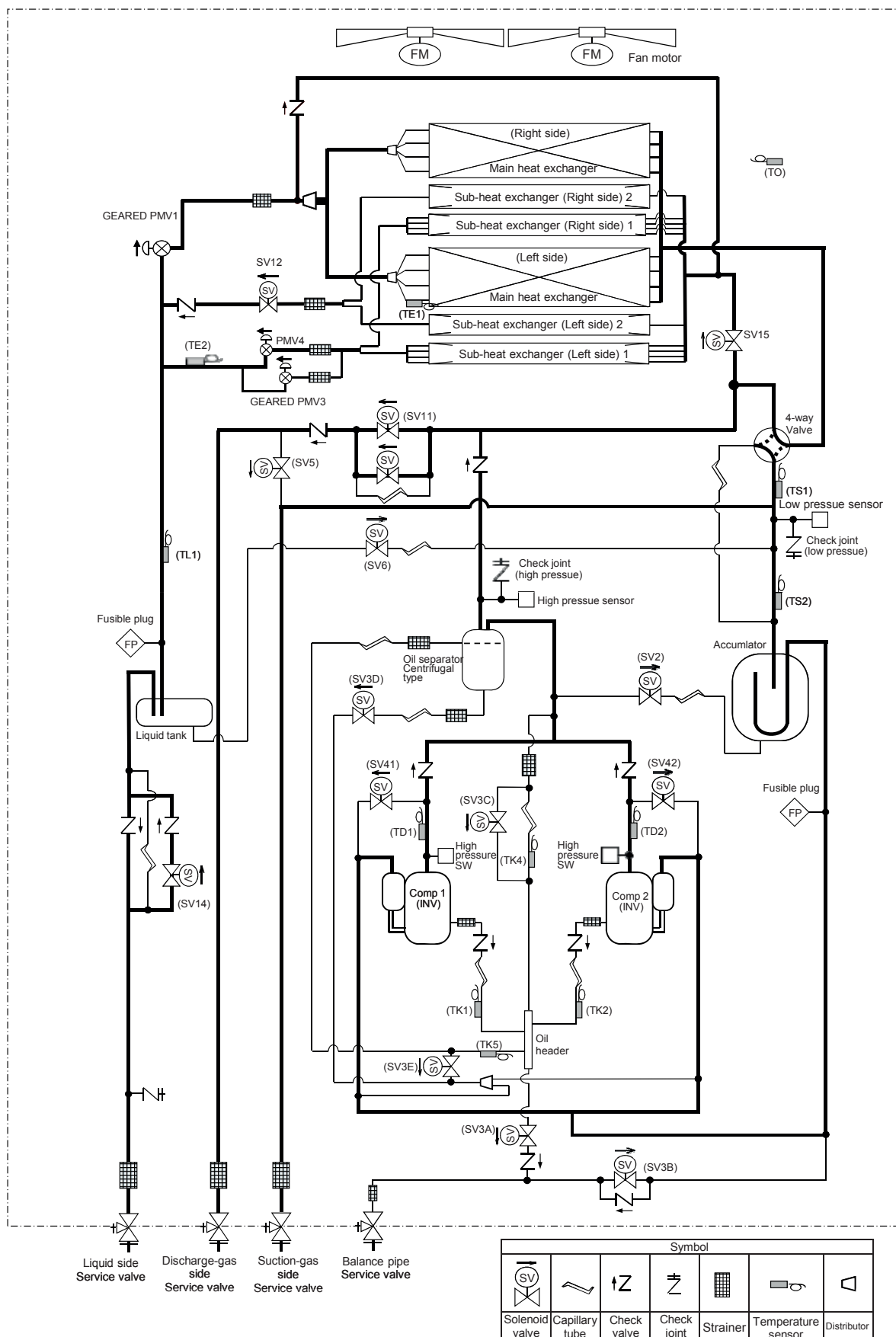



5-6. Wiring Diagrams

Model : MMY-MAP0726FT6P-UL

Symbol	Parts name
MCC-1689	Inverter P.C.Board (Compressor)
MCC-1673	Interface Control P.C.Board
MCC-1682A	Noise filter P.C.Board A
MCC-1682B	Noise filter P.C.Board B
MCC-1682C	Noise filter P.C.Board C
MCC-1659	Inverter P.C.Board (Fan)

Symbol	Parts name
4WV1	4-way valve coil
63H1,63H2	High pressure switch
CM1,CM2	Compressor
ON-R	Relay connector
ON-SS	Connector
F01,F02	Fuse (Compressor)
F01,F02	Fuse (Interface)
F01,F02,F03	Fuse (Noise filter)
F01,F02,F03	Fuse (Noise filter)
(MCC-1682C)	Fuse (Noise filter)
F70,F71	Fuse (Fan)
(MCC-1659)	Fuse (Fan)
F01	6.3A 750V/DC
FM	Fan motor
HEATER1,HEATER2	Compressor case heater
A-HEATER	Accumulator case heater
L-CM1,L-CM2	Reactor for compressor
Mf-CIT	Magnet contactor
PD	Pressure sensor (High)
PS	Pressure sensor (Low)
PMV1	Pulse motor valve (Main)
PMV3	Pulse motor valve (Sub)
PMV4	Pulse motor valve (Sub cool)
RB	Rush current protect resistor
SV2,SV3A,SV3B,SV3C	2-way valve coil
SV40,SV42,SV43,SV44	2-way valve coil
SV11,SV14,SV15,SV51	2-way valve coil
SV61	2-way valve coil
SW01,SW02,SW03	Rotary switch
SW04,SW05,SW15	Push button switch
SW06,SW07,SW09,SW10	Dip switch
SW11,SW12,SW13,SW14	Pipe temp. sensor (Discharge)
SW16,SW17,SW30,SW800	Heat exchange temp. sensor
TD1,TD2	Oil temp. sensor
TK1,TK2,TK4,TK5	Liquid temp. sensor
TO	Air temp. sensor
TS1,TS2	Pipe temp. sensor (Section)
TB1	Terminal block (Power supply)
TB2	Terminal block (Control wiring)

*2 Temperature sensor color / I/O

Symbol	Color	Wire mark (Sensorholder)
TS1	RED	TS1
TS2	RED	TS2
TK1	RED	TK1
TK2	RED	TK2
TK4	RED	TK4
TK5	RED	TK5
TO	RED	TO
TD1	RED	TD1
TD2	RED	TD2
CM1	RED	CM1
CM2	RED	CM2
ON-R	RED	ON-R
ON-SS	RED	ON-SS
F01	RED	F01
F02	RED	F02
F03	RED	F03
F70	RED	F70
F71	RED	F71
SV11	RED	SV11
SV14	RED	SV14
SV15	RED	SV15
SV51	RED	SV51
SV61	RED	SV61
SW01	RED	SW01
SW02	RED	SW02
SW03	RED	SW03
SW04	RED	SW04
SW05	RED	SW05
SW09	RED	SW09
SW10	RED	SW10
SW11	RED	SW11
SW12	RED	SW12
SW13	RED	SW13
SW14	RED	SW14
SW16	RED	SW16
SW17	RED	SW17
SW30	RED	SW30
SW800	RED	SW800
TD1	RED	TD1
TD2	RED	TD2
TK1	RED	TK1
TK2	RED	TK2
TK4	RED	TK4
TK5	RED	TK5
TO	RED	TO
TS1	RED	TS1
TS2	RED	TS2
4WV1	RED	4WV1
63H1	RED	63H1
63H2	RED	63H2
Mf-CIT	RED	Mf-CIT
PD	RED	PD
PS	RED	PS
PMV1	RED	PMV1
PMV3	RED	PMV3
PMV4	RED	PMV4
RB	RED	RB
SV2	RED	SV2
SV3A	RED	SV3A
SV3B	RED	SV3B
SV3C	RED	SV3C
SV40	RED	SV40
SV42	RED	SV42
SV43	RED	SV43
SV44	RED	SV44
SV51	RED	SV51
SV61	RED	SV61

Color indication

RED	RED
WHITE	WHITE
YELLOW	YELLOW
BLUE	BLUE
BLACK	BLACK
GRAY	GRAY
PINK	PINK
ORANGE	ORANGE
BROWN	BROWN
GREEN	GREEN
PURPLE	PURPLE

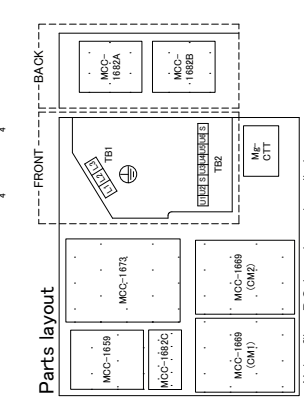
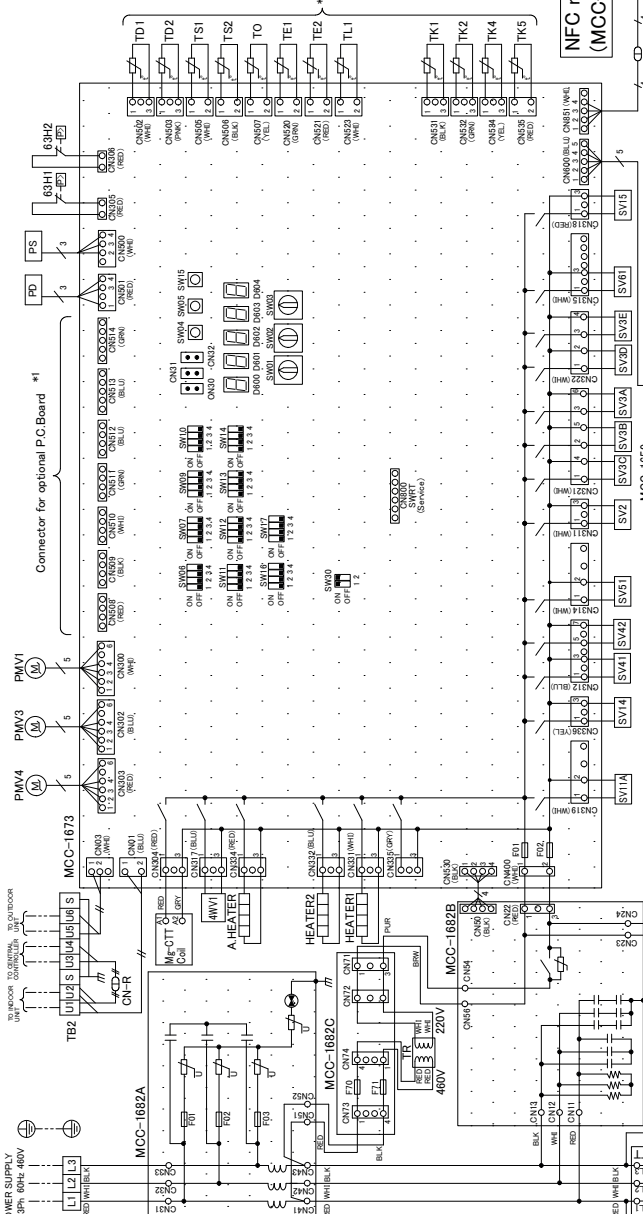

*Noise filter P.C. boards are installed on a back of terminal block.

*1 The installation of the optional board is up to four pieces.

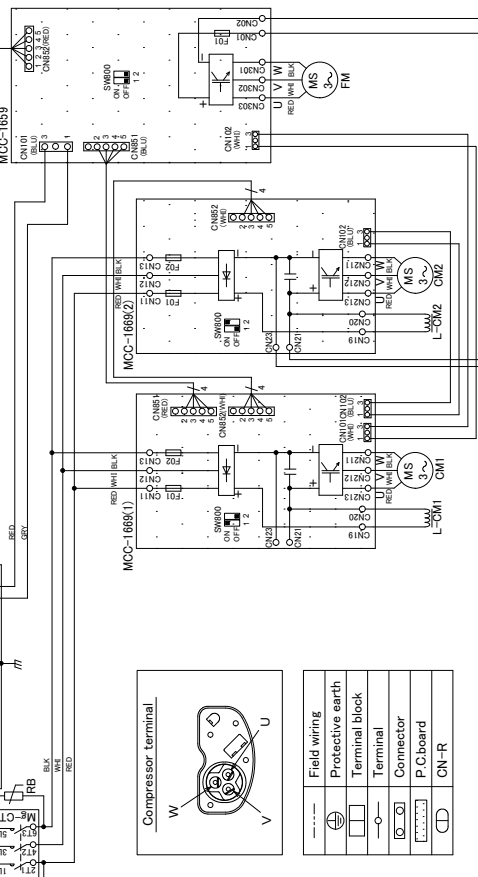

Symbol	Parts name
W, V, U	Compressor terminal
Field wiring symbol	Field wiring
Ground symbol	Protective earth
Terminal block symbol	Terminal block
Terminal symbol	Terminal
Connector symbol	Connector
P.C. board symbol	P.C. board
ON-R symbol	ON-R



Model : MMY-MAP0966FT6P-UL , MMY-MAP1206FT6P-UL

Symbol	Connector (Sensoren/Sensoren)	Parts name
MCC-1669		Inverter P.C.Board (Compressor)
MCC-1673		Interface Control P.C.Board
MCC-1682A		Noise filter P.C.Board A
MCC-1682B		Noise filter P.C.Board B
MCC-1682C		Noise filter P.C.Board C
MCC-1659		Inverter P.C.Board (Fan)

Symbol	Parts name
4WV1	4-way valve coil
63H1,63H2	High pressure switch
CM1,CM2	Compressor
CM-R	Relay connector
CM**	Connector
(MCC-1669)	Fuse (Compressor)
FU1,FU2	315A 500VAC
(MCC-1673)	Fuse (Interface)
FU1,FU2	T6.3A 250VAC
(MCC-1682A)	Fuse (Noise filter)
FU1,FU2,FU3	T6.3A 250VAC
(MCC-1682C)	Fuse (Noise filter)
FU1,FU1	3.15A 600VAC
(MCC-1659)	Fuse (Fan)
FU1	6.3A 750VDC
FM	Fan motor
HEATER1,HEATER2	Compressor case heater
A-HEATER	Accumulator case heater
L-CM1,L-CM2	Reactor for compressor
Me-C1T	Magnet contactor
PS	Pressure sensor (High)
PS	Pressure sensor (Low)
PMV1	Pulse motor valve (Main)
PMV3	Pulse motor valve (Sub)
PMV4	Pulse motor valve (Sub coil)
RB	Rush current protect resistor
SV2,SV3A,SV3B,SV3C	2-way valve coil
SV3D,SV8E,SV41,SV42	
SV51,SV11A,SV11B	
SV14,SV15,SV61	
SW01,SW2,SW3	Rotary switch
SW04,SW05,SW15	Push button switch
SW06,SW07,SW08,SW10	
SW11,SW12,SW13,SW14	
SW16,SW17,SW60,SW600	
TD1,TD2	Dip switch
TK1,TK2,TK4,TK5	Pipe temp. sensor (Discharge)
TL1	Heat exchange temp. sensor
TL1	Liquid temp. sensor
TO	Air temp. sensor
TS1,TS2	Pipe temp. sensor (Suction)
TB1	Terminal block(Power supply)
TB2	Terminal block(Control wiring)
TB3	Terminal block(internal wiring connector)

*2 Temperature sensor code / D

Symbol	No.	color	Color indication
TD1	DN502	WHI	WHI/WHITE
TD2	DN503	PNK	BLU/YELLOW
TD3	DN504	RED	BLU/BLUE
TD4	DN505	RED	GRN/YEL
TD5	DN506	RED	GRN/GRY
TK1	DN531	BLK	GRN/GRY
TK2	DN532	GRN	PNK/PNK
TK4	DN534	BLU	ORN/ORN
TK5	DN535	WHI	BRN/BROWN
TL1	DN536	WHI	GRN/BROWN
TL2	DN537	WHI	GRN/BROWN
TL3	DN538	WHI	PUR/PURPLE
TS1	DN505	WHI	GRY
TS2	DN506	BLK	BLK

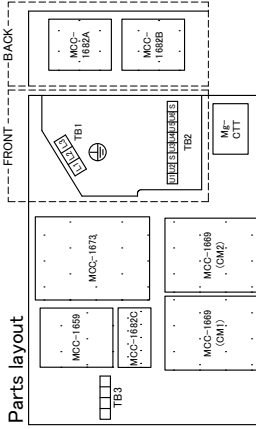
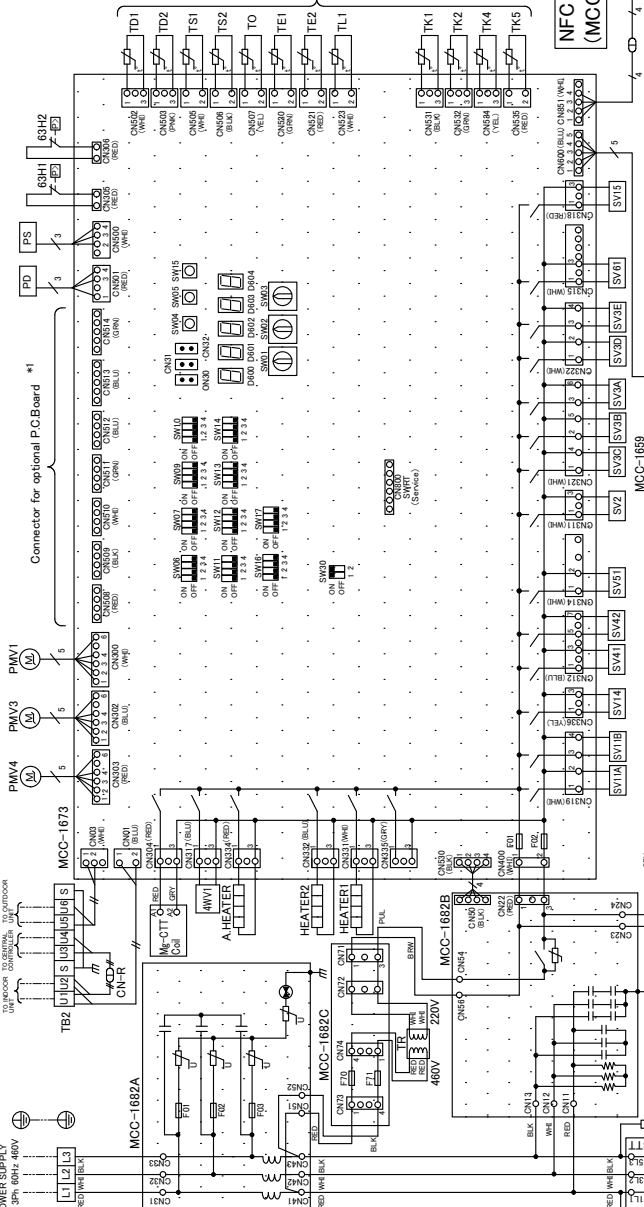

*Noise filter P.C boards are installed on a back of terminal block.
 *1 The installation of the optional board is up to four pieces.

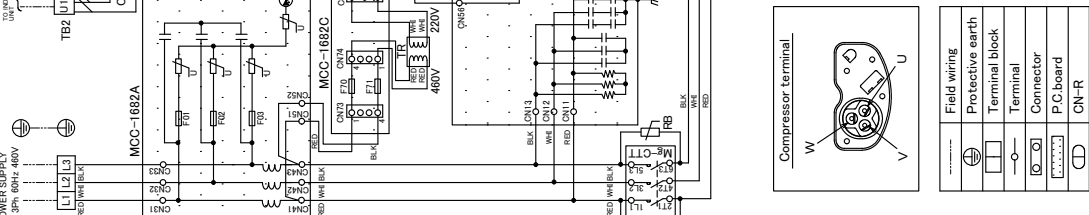



Model : MMY-MAP1446FT6P-UL , MMY-MAP1686FT6P-UL

Symbol	Parts name
MCC-1689	Inverter P.C. Board (Compressor)
MCC-1673	Interface Control P.C. Board
MCC-1682A	Noise filter P.C. Board A
MCC-1682B	Noise filter P.C. Board B
MCC-1682C	Noise filter P.C. Board C
MCC-1689	Inverter P.C. Board (Fan)

Symbol	Parts name
4WV1	4-way valve coil
63H1.63H2	High pressure switch
CM1. CM2	Compressor
CN-R	Relay connector
CN-R**	Connector
(MCC-1689)	Fuse (Compressor)
F01.F02	31.5A 500VAC Fuse (Interface)
F01.F02	T6.3A 250VAC Fuse (Noise filter)
F01.F02.F03	T6.3A 250VAC Fuse (Noise filter)
(MCC-1682C)	Fuse (Noise filter)
F70.F71	31.5A 600VAC Fuse (Fan)
(MCC-1689)	Fuse (Fan)
F01	6.3A 750VDC Fan motor
FMI.FM2	Compressor case heater
HEATER1. HEATER2	Accumulator case heater
A. HEATER	Reactor for compressor
L- CM1. L- CM2	Magnet contactor
Mg- CTT	Pressure sensor (High)
PS	Pressure sensor (Low)
PMV1	Pulse motor valve (Main)
PMV3	Pulse motor valve (Sub)
PMV4	Pulse motor valve (Sub cool)
RB	Rush current protect resistor
SVZ. SV3A. SV3B. SV3C	2-way valve coil
SV3D. SV3E. SV11A	2-way valve coil
SV11B. SV12. SV14. SV15	Retary switch
SV41. SV42. SV51. SV61	Push button switch
SW01. SW02. SW03	Retary switch
SW04. SW05. SW15	Push button switch
SW06. SW07. SW08. SW10	Dip switch
SW11. SW12. SW13. SW14	Dip switch
SW16. SW17. SW30. SW800	Dip switch
TD1. TD2	Pipe temp. sensor (Discharge)
TE1. TE2	Heat exchange temp. sensor
TK1. TK2. TK4. TK5	Oil temp. sensor
TL1	Liquid temp. sensor
TO	Air temp. sensor
TS1. TS2	Pipe temp. sensor (Suction)
TB1	Terminal block(Power supply)
TB2	Terminal block(Control wiring)
TB3	Terminal block(Internal wiring connector)

42 Temperature sensor color / D

Symbol	Wire mark (Sensimolder)	Color
TD1	CN202	WH
TD2	CN203	PNK
TE1	CN200	GRN
TE2	CN201	RED
TK1	CN211	RED
TK2	CN212	BLK
TK4	CN234	YEL
TK5	CN235	RED
TL1	CN207	YEL
TO	CN207	YEL
TS1	CN208	BLK
TS2	CN209	BLK

Color indication

WH/WHITE
YEL/YELLOW
BLK/BLACK
GRN/GREEN
PNK/PINK
GRY/GRAY
PRN/PURPLE
ORN/ORANGE
BRN/BROWN
GRN/GREEN
PUR/PURPLE

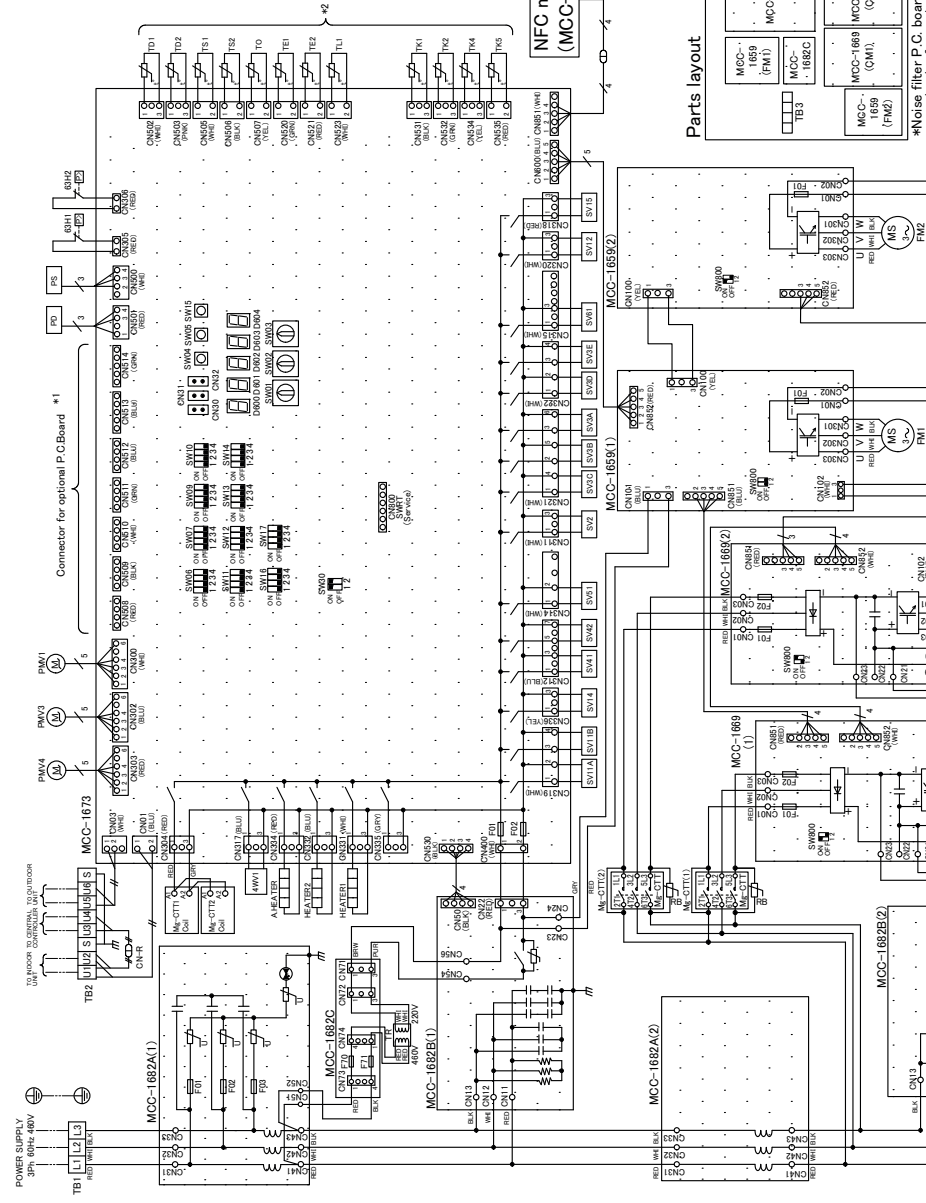

Field wiring	Terminal block	Terminal	Connector	P.C. board	CN-R

Model : MMY-MAP0726FT9P-UL

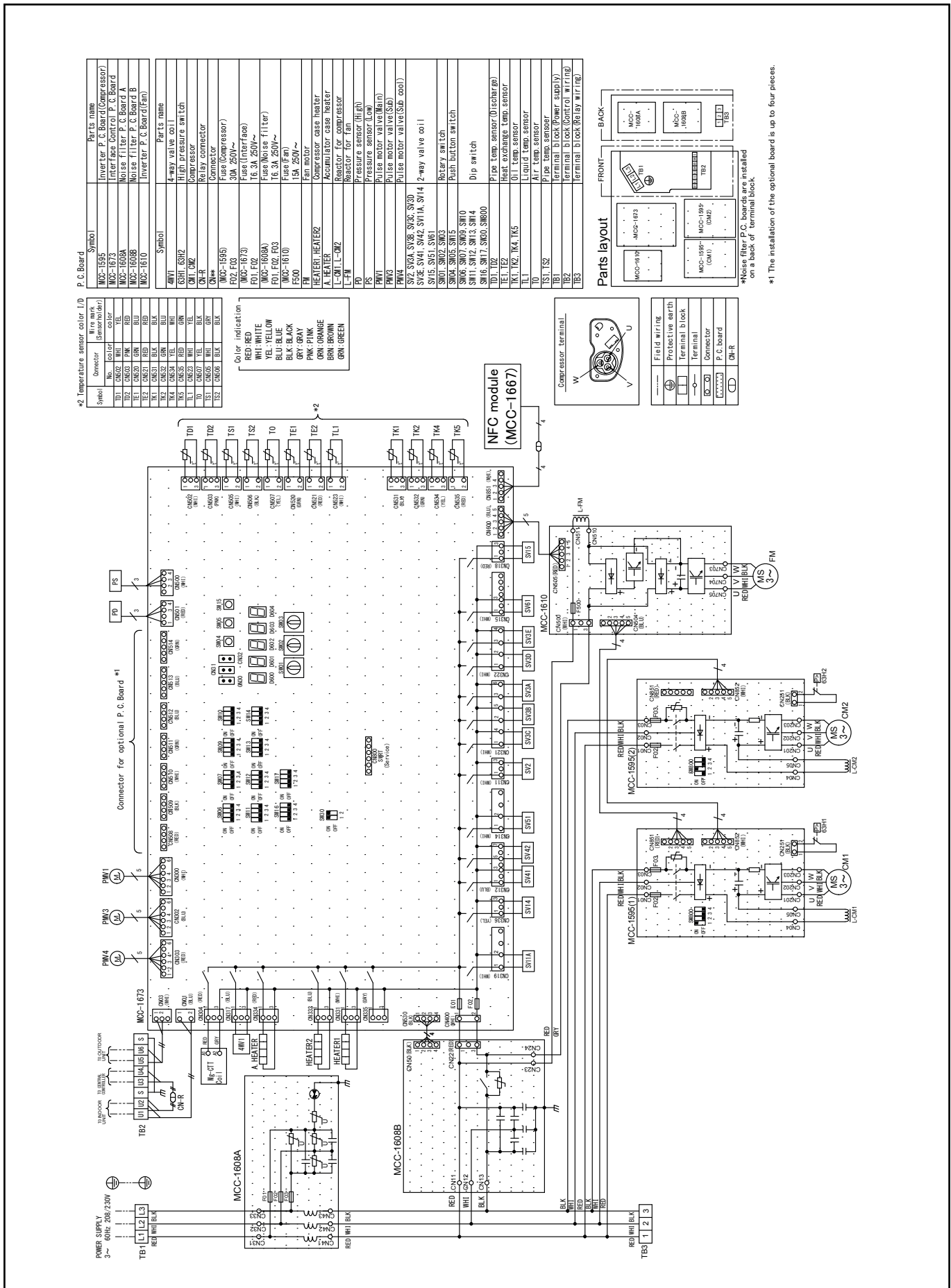



Model : MMY-MAP0966FT9P-UL , MMY-MAP1206FT9P-UL

Symbol	Parts name
MCC-1595	Inverter P.C. Board (Compressor)
MCC-1673	Interface Control P.C. Board
MCC-1608A	Noise filter P.C. Board A
MCC-1608B	Noise filter P.C. Board B
MCC-1610	Inverter P.C. Board (Fan)
4W1	4-way valve coil
63H1, 63H2	High pressure switch
CM2	Compressor
CM-R	Relay compressor
CM-S	Connector
CM-H	Fuse (Compressor)
F02, F03	30A, 250V~
F04	Fuse (Interface)
F05	Fuse (Noise filter)
F06	Fuse (Noise filter)
F07, F08, F09	16, 3A, 250V~
F10	Fuse (Fan)
F500	Fan motor
F11	Compressor case heater
HEATER, HEATER2	Accumulator case heater
A-HEATER	Reactor for compressor
L-CMT, L-CM2	Reactor for fan
FP	Pressure sensor (High)
FP2	Pressure sensor (Low)
FM1	Fuse motor valve (S&C)
FM2	Fuse motor valve (S&C)
FM4	Fuse motor valve (S&C coil)
SV2, SV3A, SV3B, SV3C, SV3D	2-way valve coil
SV3E, SV11A, SV11B, SV14	Rotary switch
SV15, SV41, SV42, SV51, SV61	Push button switch
SM1, SM2, SM3	Dip switch
SM4, SM5, SM15	Pipe temp. sensor (Discharge)
SM6, SM7, SM9, SM10	Heat exchanger temp. sensor
SM11, SM12, SM13, SM14	Oil temp. sensor
SM15, SM17, SM20, SM200	Liquid temp. sensor
TD1, TD2	Air temp. sensor
TE1, TE2	Pipe temp. sensor
TK1, TK2, TK4, TK5	Terminal block (Power supply)
TL1	Terminal block (Control wiring)
TL2	Terminal block (Relay wiring)
TL3	Terminal block (Relay wiring)
TL4	Terminal block (Relay wiring)

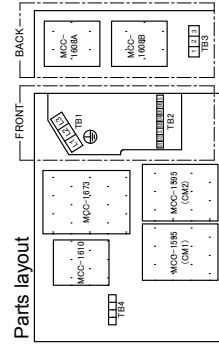

*Noise filter P.C. boards are installed on a back of terminal block.
*1 The installation of the optional board is up to four pieces.

*2 Temperature sensor color 1/0

Symbol	Connector No.	Wire mark color (Semiconductor)	Color
TD1	0N602	WHI	YEL
TD2	0N603	PKM	RED
TE1	0N620	GRN	BLU
TE2	0N621	RED	BLK
TK1	0N631	BLK	BLK
TK2	0N632	GRN	BLU
TK4	0N634	YEL	WHI
TK5	0N635	RED	GRN
TL1	0N607	WHI	YEL
TL2	0N607	YEL	BLK
TL3	0N606	WHI	GRY
TL4	0N606	BLK	BLK

Color indication
 RED: RED
 WHI: WHITE
 YEL: YELLOW
 BLU: BLUE
 BLK: BLACK
 GRY: GRAY
 PKM: PINK
 ORN: ORANGE
 BRN: BROWN
 GRN: GREEN

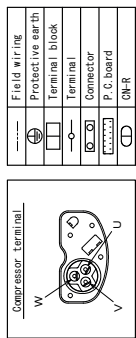
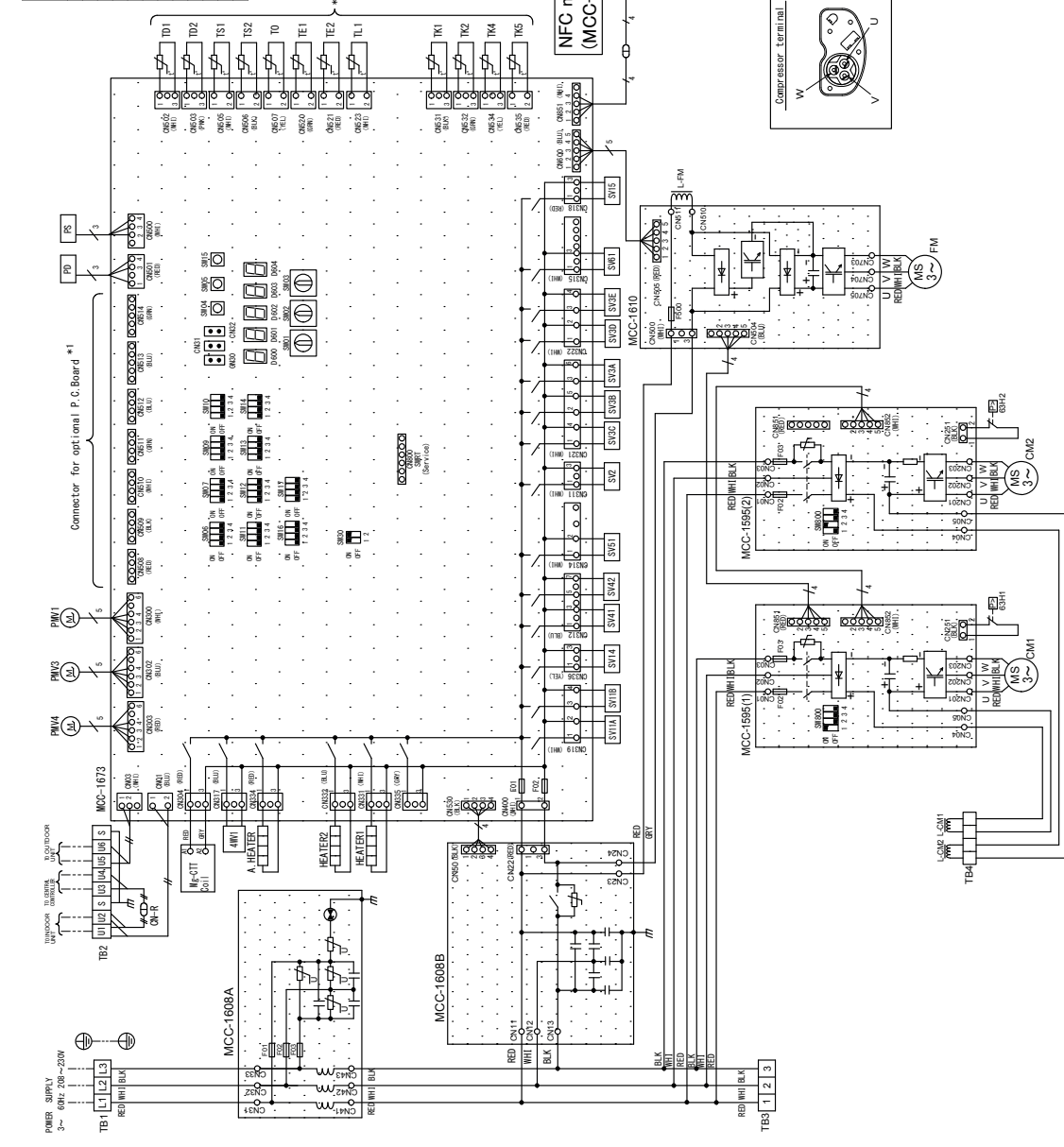

Field wiring
Protective earth
Terminal block
Terminal
Connector
P.C. board
CM-R



Model : MMY-MAP1446FT9P-UL , MMY-MAP1686FT9P-UL

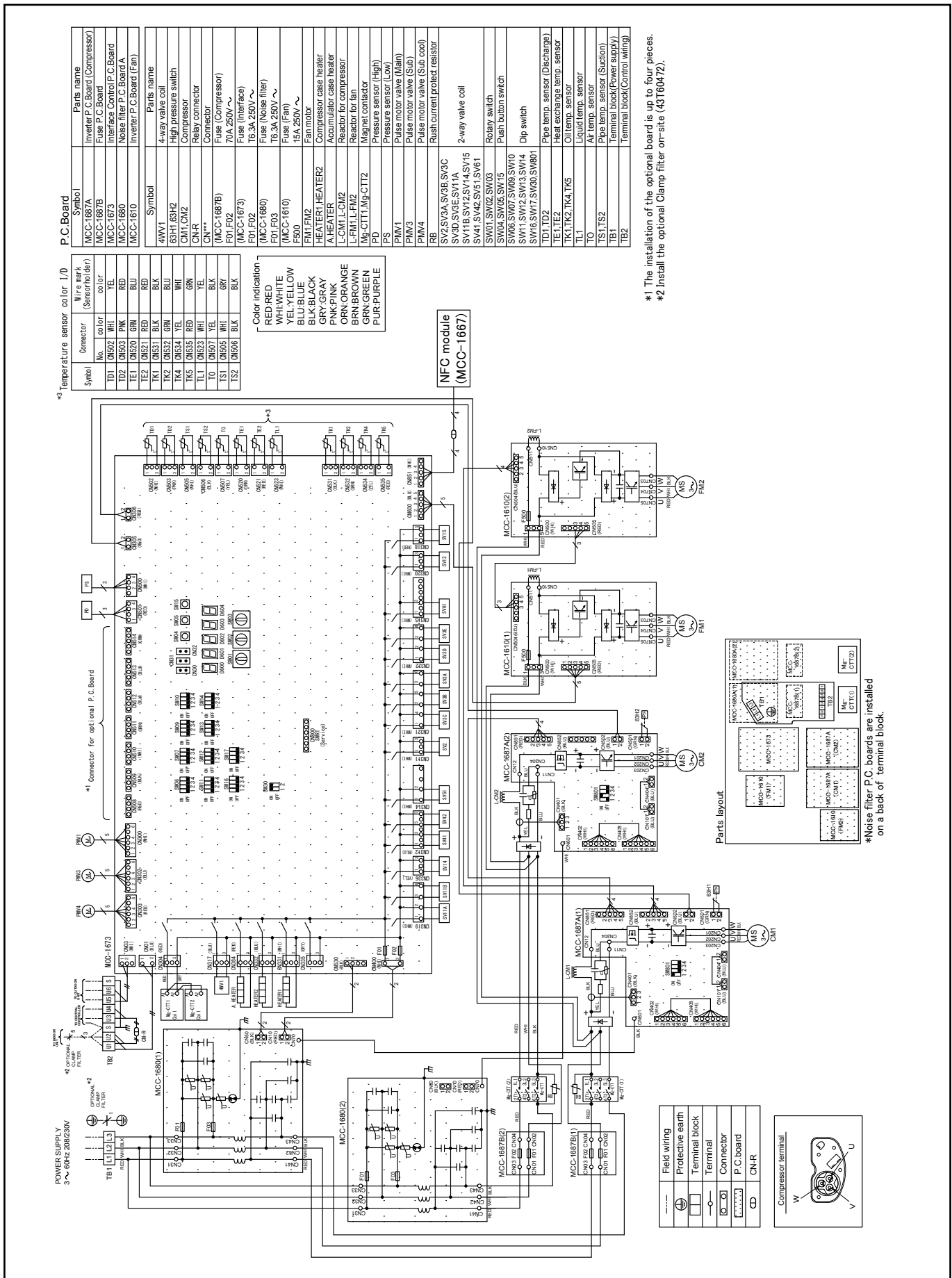

Symbol	Parts name
MCC-1687A	Inverter P.C. Board (Compressor)
MCC-1687B	Fuse P.C. Board
MCC-1673	Interface Control P.C. Board
MCC-1680	Noise filter P.C. Board A
MCC-1610	Inverter P.C. Board (Fan)
4WV1	4-way valve coil
63H1.63H2	High pressure switch
CM1.CM2	Compressor
CNR	Relay connector
CN***	Connector
(MCC-1687B)	Fuse (Compressor)
F01.F02	Fuse (Interface)
(MCC-1673)	Fuse (Interface)
(MCC-1680)	Fuse (Noise filter)
F01.F03	Fuse (Noise filter)
(MCC-1610)	Fuse (Fan)
F900	Fuse (Fan)
FM1.FM2	Fan motor
HEATER1.HEATER2	Compressor case heater
A.HEATER	Accumulator case heater
L.CM1.L.CM2	Reactor for compressor
L.FM1.L.FM2	Reactor for fan
M.CTT1.Mg.CTT2	Magnet contactor
PS	Pressure sensor (High)
PMV3	Pressure sensor (Low)
PMW1	Pulse motor valve (Main)
PMW3	Pulse motor valve (Sub)
PMW4	Pulse motor valve (Sub cool)
RB	Rush current protect resistor
SV2.SV3A.SV3B.SV3C	2-way valve coil
SV3D.SV3E.SV3F	Relay switch
SV1B.SV12.SV14.SV15	Push button switch
SV41.SV42.SV51.SV61	Dip switch
SV01.SV02.SV03	Pipe temp. sensor (Discharge)
SV04.SV09.SV10	Heat exchange temp. sensor
SV06.SV07.SV08.SV10	Liquid temp. sensor
SV11.SV12.SV13.SV14	Oil temp. sensor
SV16.SV17.SV30.SV801	Air temp. sensor
TD1.TD2	Pipe temp. sensor (Suction)
TK1.TK2.TK4.TK5	Terminal block(Power supply)
TL1	Terminal block(Control wiring)
TO	
TS1.TS2	
TB1	
TB2	

*1 The installation of the optional filter on-site is up to four pieces.
 *2 Install the optional Clamp filter on-site (43T60472).

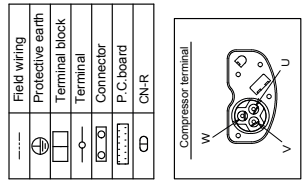



Model : MMY-MAP0726FT2P-UL

Symbol	Symbol	Parts name
MCC-1682	Inverter P.C. Board (Compressor)	
MCC-1683	Filter fan (Control P.C. Board)	
MCC-1682A	Noise filter P.C. Board A	
MCC-1682B	Noise filter P.C. Board B	
MCC-1610	Inverter P.C. Board (fan)	

Symbol	Parts name
4W1	4-way valve coil
6SH2	High pressure switch
CM1, CM2	Compressor
CM-R	Relay connector
CM**	Connector
F01	Fuse (Compressor)
MCC-1683	Fuse (Compressor)
ZSA, ZSB	Fuse (Sub-cool)
F02, F03	Fuse (Filter fan)
MCC-1682A	Fuse (Noise filter)
F02, F03	Fuse (Fan)
F500	Fuse (Fan)
FM	Fan motor
HEATER, HEATER2	Compressor case heater
A-HEATER	Accumulator case heater
L-OM1, L-OM2	Reactor for fan
PD	Pressure sensor (High)
PS	Pressure sensor (Low)
PM1	Pulse motor valve (Main)
PM3	Pulse motor valve (Sub)
PM4	Pulse motor valve (Sub-cool)
SV2, SV3A, SV3B, SV3C	2-way valve coil
SV3D, SV3E, SV11A, SV14	Rotary switch
SV15, SV41, SV42, SV51	Push button switch
SM1, SM2, SM3	Dip switch
SM4, SM5, SM13	Pipe Temp. sensor (Discharge)
SM6, SM7, SM8, SM10	Heat exchange Temp. sensor
SM11, SM12, SM13, SM14	OT Temp. sensor
SM15, SM17, SM20, SM800	LI Temp. sensor
TD1, TD2	LI Temp. sensor
TK1, TK2, TK4, TK5	LI Temp. sensor
TL1	Pipe Temp. sensor
TS1, TS2	Terminal block (Power supply)
TB1	Terminal block (Control wiring)
TB2	Terminal block (Relay wiring)

4- Temperature sensor color (J/D)

Symbol	Connector No.	Color	Symbol (Sensor color)
TS1	CM502	WHI	WHI
TD1	CM502	WHI	WHI
TD2	CM503	PKM	RED
TS2	CM503	PKM	RED
TL1	CM503	BLU	BLU
TL2	CM503	BLU	BLU
TK1	CM503	BLK	BLK
TK2	CM503	BLK	BLK
TK4	CM503	BLK	BLK
TK5	CM503	RED	RED
TL3	CM505	WHI	WHI
TL4	CM505	WHI	WHI
TL5	CM505	WHI	WHI
TS3	CM506	BLK	BLK

Color indication

RED	RED
WHI	WHITE
YEL	YELLOW
BLU	BLUE
BLK	BLACK
GRY	GRAY
PKM	PINK
ORN	ORANGE
BRN	BROWN
GRN	GREEN

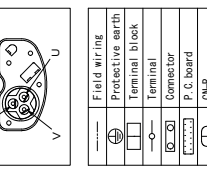
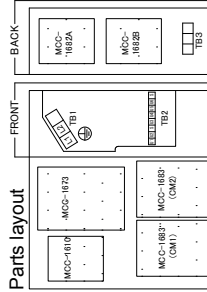
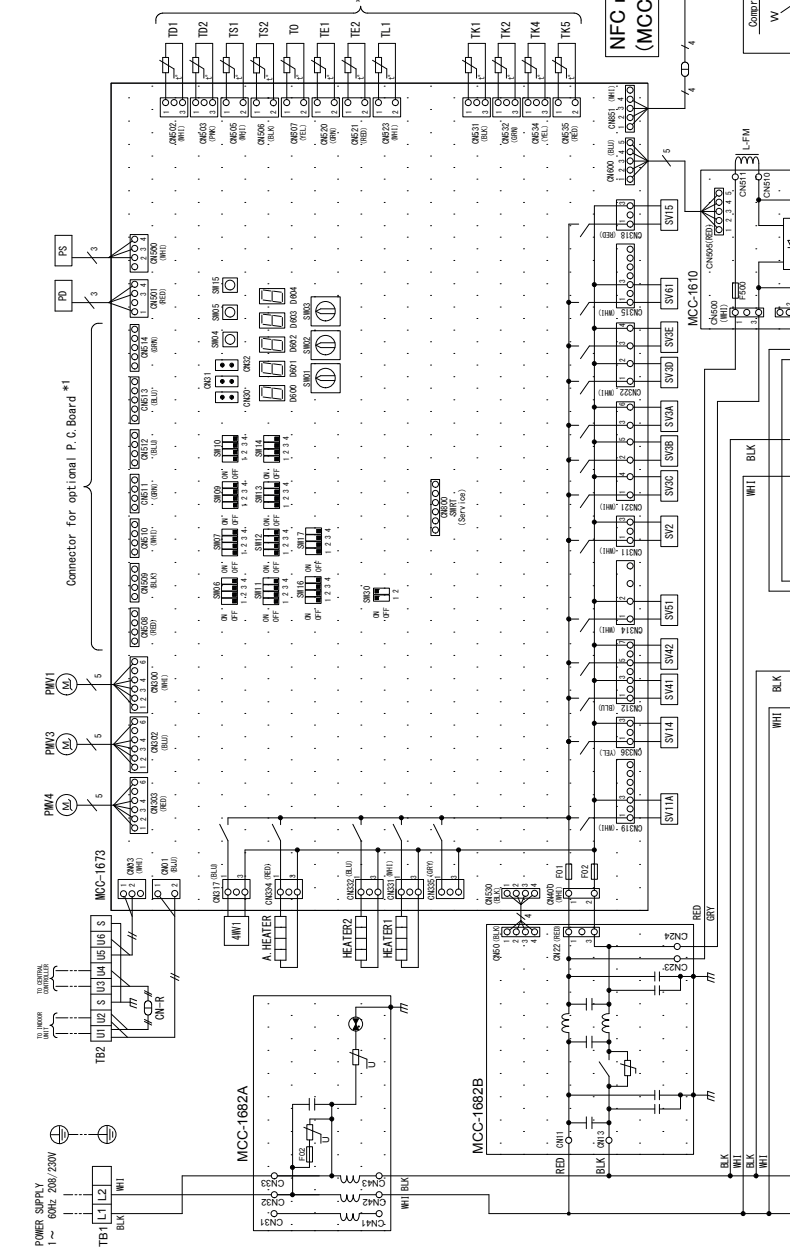

*Noise filter P.C. boards are installed on a back of terminal block.
 *1 The installation of the optional board is up to four pieces.

5-7. Connecting Diagrams

Single Unit connecting with single FS unit

Model : MMY-MAP***6FT6P-UL

- (Note)**
1. When using a central control, plug in the connector between [U1, U2] and [U3, U4] terminal of the header unit. (At shipment from factory : No connection)
 2. Connect the closed end terminal of shield wire. (Connected to all connecting sections in each unit)
 3. Group control.
 4. Power supply wiring to be per NEC and local codes.
 5. For the control wires connecting indoor units, outdoor units, and between indoor and outdoor units, use 2-core and non-polarity shield wires.
 6. For additional details, see the individual unit wiring diagrams. (Indoor & Outdoor)

①	Outdoor unit (Header unit)
②	—
③	Indoor unit
④	Flow selector unit (FS unit)
⑤	Remote controller
⑥	Central remote controller (option)
⑦	Disconnect switch for NEC
⑧	Circuit breaker

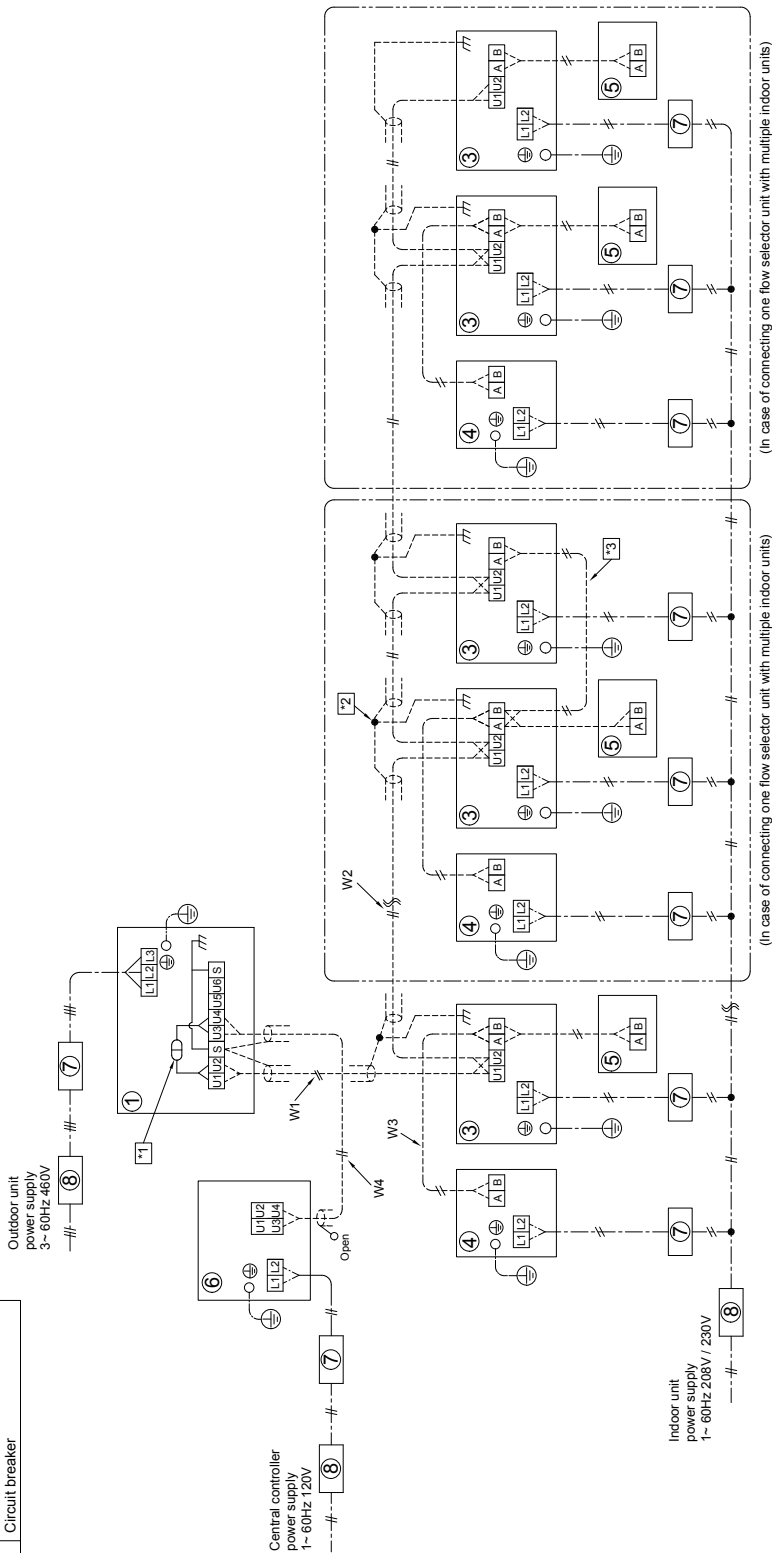

<Connecting with Single FS unit (Long piping model)>

Single Unit connecting with multi type FS unit

Model : MMY-MAP*6FT6P-UL**

- (Note)**
- When using a central control, plug in the connector between [U1,U2] and [U3,U4] terminal of the header unit.
 - Connect the shield or all control wiring to the ground screw on every unit. (Indoor & Outdoor)
 - Group control.
 - Power supply wiring to be per NEC and local codes.
 - For the control wires connecting indoor units, outdoor units, and between indoor and outdoor units, use 2-core shielded wires.
 - For additional details, see the individual unit wiring diagrams. (Indoor & Outdoor)

Shield wire	
W1	: Shielded control wiring between indoor and outdoor units
W2	: Shielded control wiring between indoor unit
W3	: Control wiring between indoor and flow selector units
W4	: Shielded central control wiring

①	Outdoor unit (Header unit)
②	—
③	Indoor unit
④	Flow selector unit (FS unit)
⑤	Remote controller
⑥	Central remote controller (option)
⑦	Disconnect switch for NEC
⑧	Circuit breaker

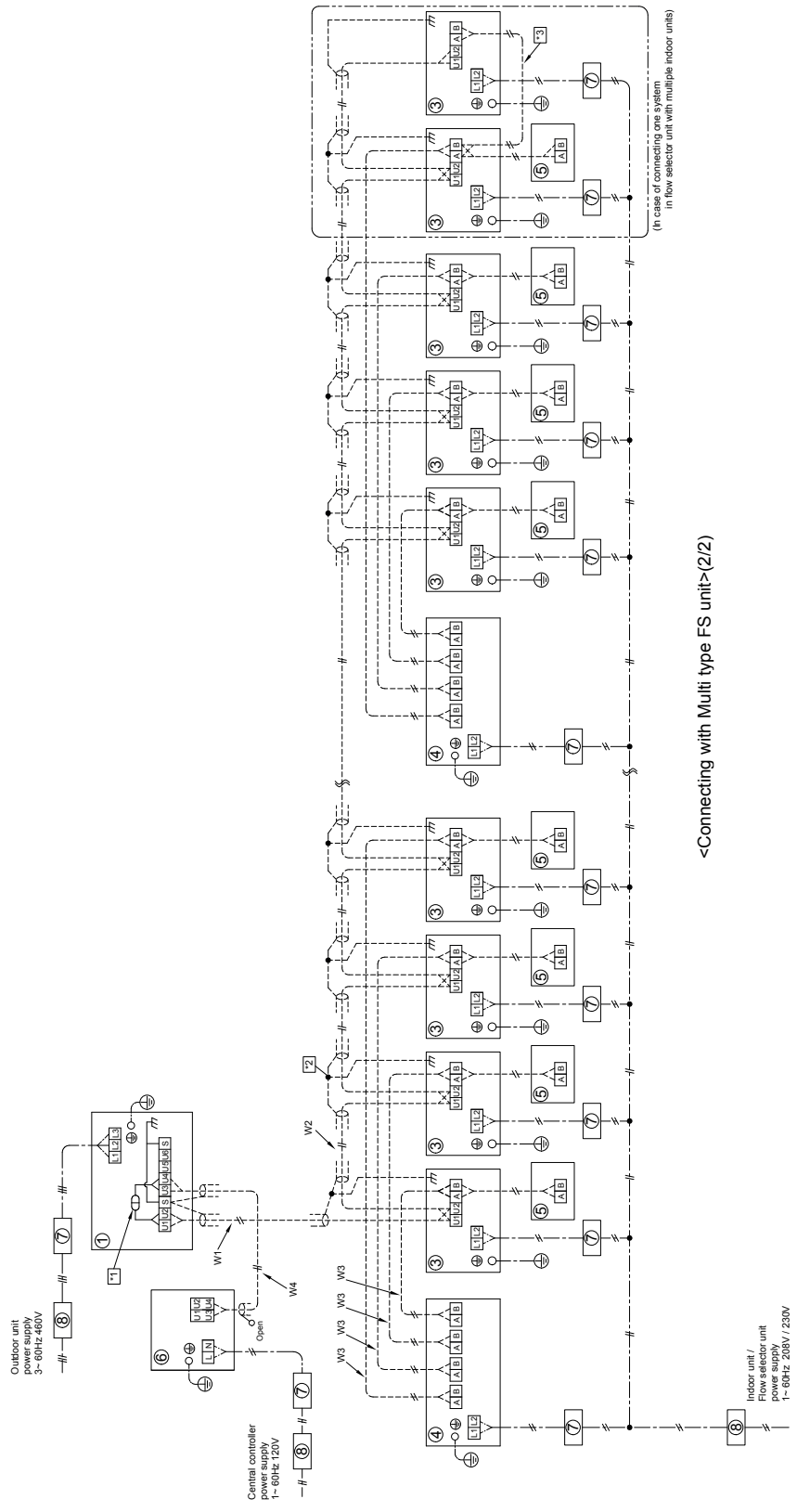

(In case of connecting one system in flow selector unit with multiple indoor units)

<Connecting with Multi type FS unit>(2/2)

Two Units connecting with single FS unit.

Model : MMY-AP*6FT6P-UL**

- (Note)**
1. When using a central control, plug in the connector between [U1,U2] and [U3,U4] terminal of the header unit. (At shipment from factory : No connection)
 2. Connect the closed end terminal of shield wire. (Connected to all connecting sections in each unit)
 3. Group control.
 4. Power supply wiring to be per NEC and local codes.
 5. For the control wires connecting indoor units, outdoor units, and between indoor and outdoor units, use 2-core and non-polarity shield wires.
 6. For additional details, see the individual unit wiring diagrams. (Indoor & Outdoor)

Shield wire	
W1	: Shielded control wiring between indoor and outdoor units
W2	: Shielded control wiring between indoor unit
W3	: Shielded control wiring between outdoor units
W4	: Control wiring between indoor and flow selector units
W5	: Shielded central control wiring

①	Outdoor unit (Header unit)
②	Outdoor unit (Follower unit)
③	Indoor unit
④	Flow selector unit (FS unit)
⑤	Remote controller
⑥	Central remote controller (option)
⑦	Disconnect switch for NEC
⑧	Circuit breaker

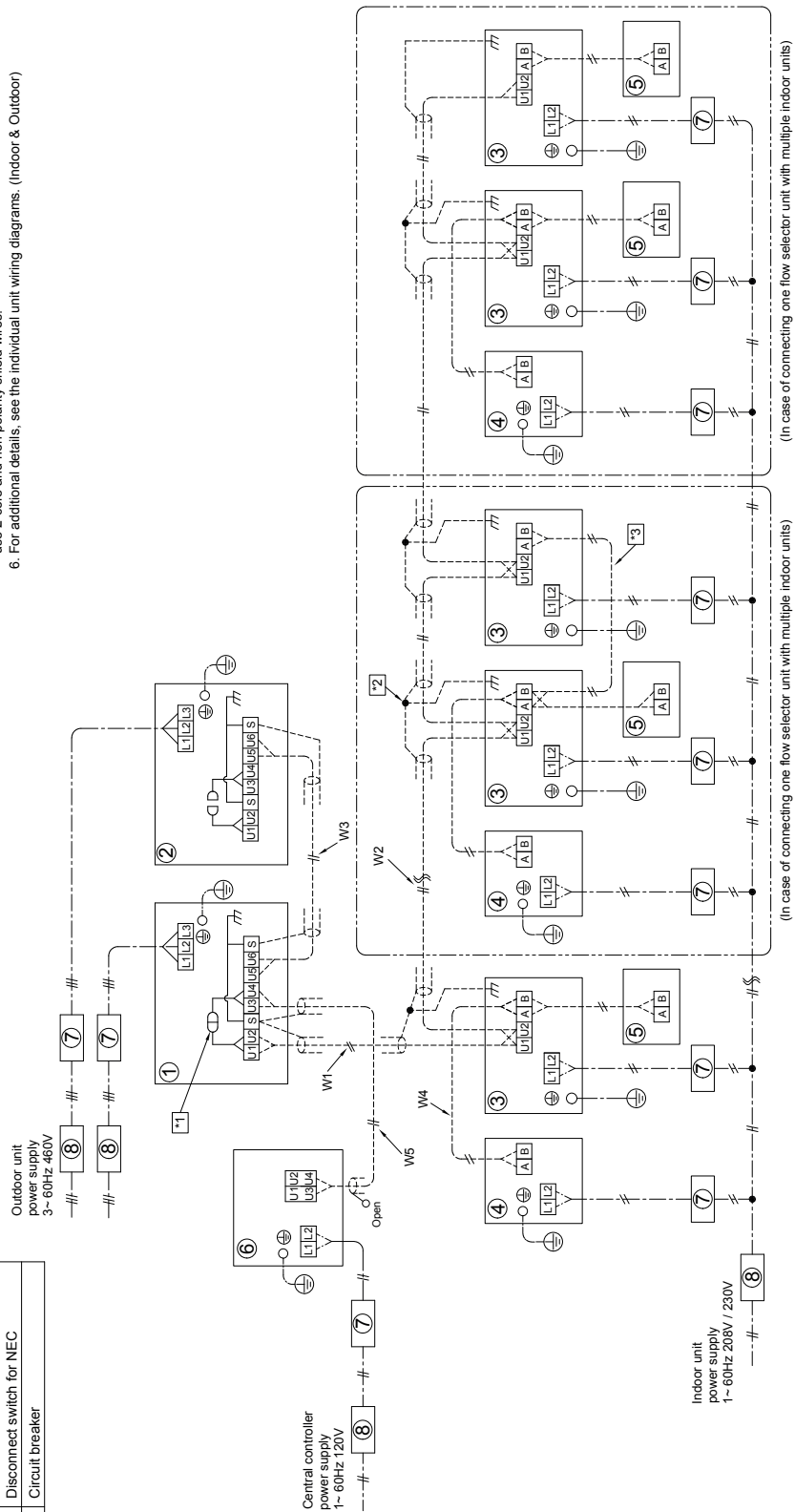

<Connecting with Single FS unit (Long piping mode)>

Two Units connecting with multi type FS unit.
Model : MMY-AP*6FT6P-UL**

- (Note)**
1. When using a central control, plug in the connector between [U1,U2] and [U3,U4] terminal of the header unit.
 2. Connect the shield of all control wiring to the ground screw on every unit. (Indoor & Outdoor)
 3. Group control.
 4. Power supply wiring to be per NEC and local codes.
 5. For the control wires connecting indoor units, outdoor units, and between indoor and outdoor units, use 2-core shielded wires.
 6. For additional details, see the individual unit wiring diagrams. (Indoor & Outdoor)

Shield wire	
W1	: Shielded control wiring between indoor and outdoor units
W2	: Shielded control wiring between indoor unit
W3	: Shielded control wiring between outdoor units
W4	: Control wiring between indoor and flow selector units
W5	: Shielded central control wiring

①	Outdoor unit (Header unit)
②	Outdoor unit (Follower unit)
③	Indoor unit
④	Flow selector unit (FS unit)
⑤	Remote controller
⑥	Central remote controller (option)
⑦	Disconnect switch for NEC
⑧	Circuit breaker

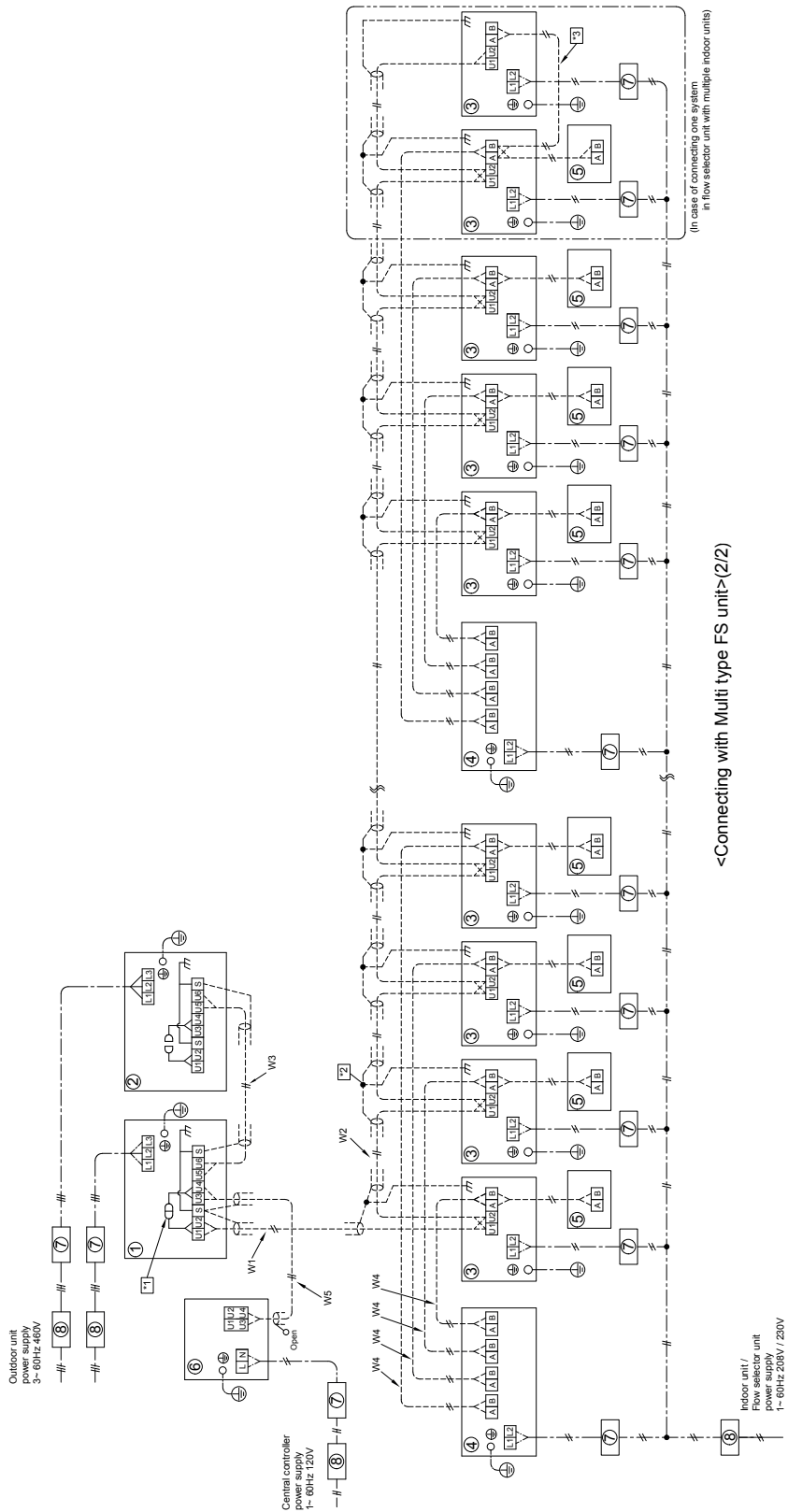

<Connecting with Multi type FS unit>(2/2)



Three Units connecting with single type FS unit.

Model : MMY-AP***6FT6P-UL

- (Note)**
1. When using a central control, plug in the connector between [U1, U2] and [U3, U4] terminal of the header unit. (At shipment from factory : No connection)
 2. Connect the closed end terminal of shield wire. (Connected to all connecting sections in each unit)
 3. Group control.
 4. Power supply wiring to be per NEC and local codes.
 5. For the control wires connecting indoor units, outdoor units, and between indoor and outdoor units, use 2-core and non-polarity shield wires.
 6. For additional details, see the individual unit wiring diagrams. (Indoor & Outdoor)

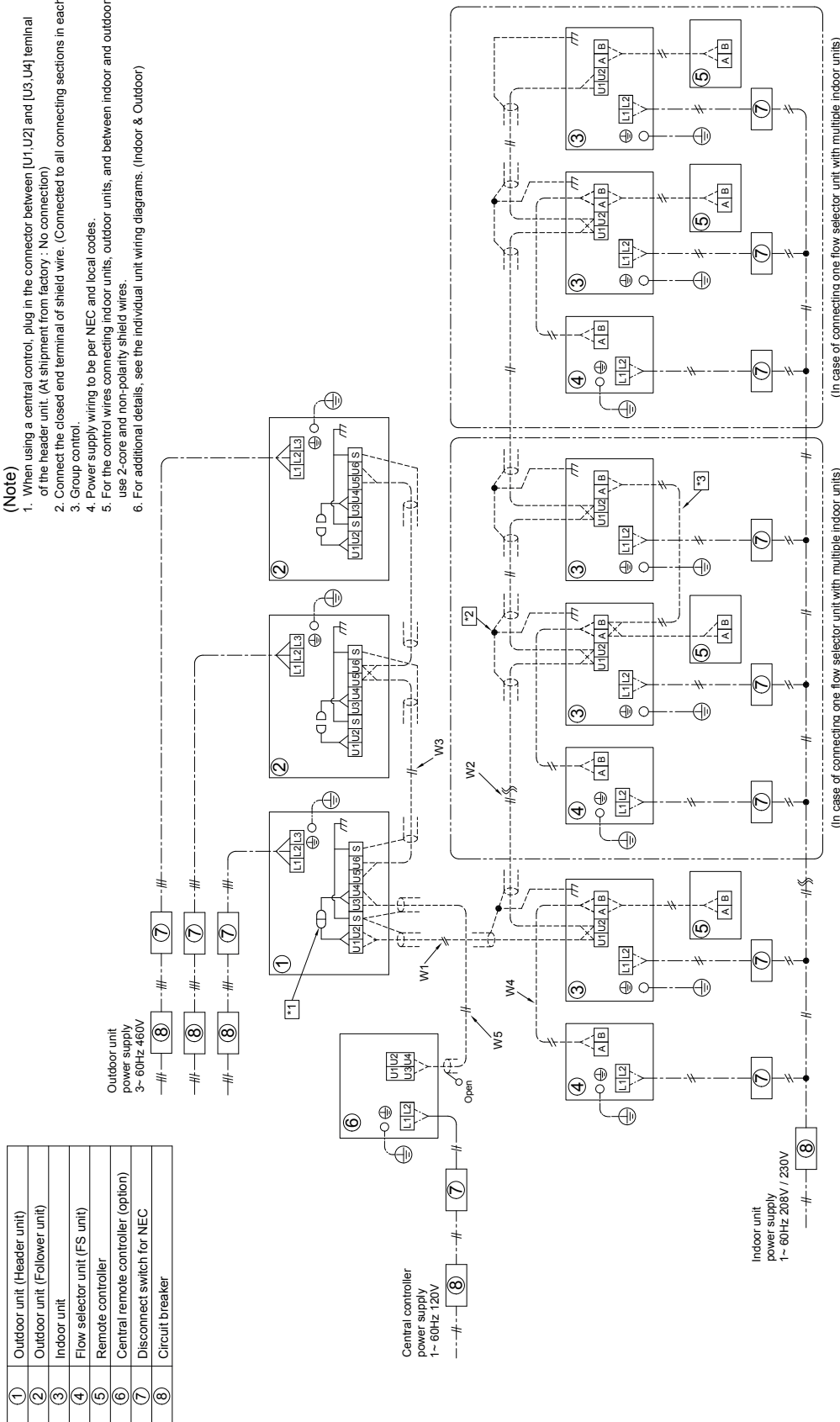

①	Outdoor unit (Header unit)
②	Outdoor unit (Follower unit)
③	Indoor unit
④	Flow selector unit (FS unit)
⑤	Remote controller
⑥	Central remote controller (option)
⑦	Disconnect switch for NEC
⑧	Circuit breaker

Shield wire
W1 : Shielded control wiring between indoor and outdoor units
W2 : Shielded control wiring between indoor unit
W3 : Shielded control wiring between outdoor units
W4 : Control wiring between indoor and flow selector units
W5 : Shielded control wiring

<Connecting with Single FS unit (Long piping model)>

Three Units connecting with multi type FS unit.
Model : MMY-AP*6FT6P-UL**

- (Note)**
1. When using a central control, plug in the connector between [U1,U2] and [U3,U4] terminal of the header unit.
 2. Connect the shield of all control wiring to the ground screw on every unit. (Indoor & Outdoor)
 3. Group control.
 4. Power supply wiring to be per NEC and local codes.
 5. For the control wires connecting indoor units, outdoor units, and between indoor and outdoor units, use 2-core shielded wires.
 6. For additional details, see the individual unit wiring diagrams. (Indoor & Outdoor)

Shield wire	
W1	: Shielded control wiring between indoor and outdoor units
W2	: Shielded control wiring between indoor unit
W3	: Shielded control wiring between outdoor units
W4	: Control wiring between indoor and flow selector units
W5	: Shielded central control wiring

①	Outdoor unit (Header unit)
②	Outdoor unit (Follower unit)
③	Indoor unit
④	Flow selector unit (FS unit)
⑤	Remote controller
⑥	Central remote controller (option)
⑦	Disconnect switch for NEC
⑧	Circuit breaker

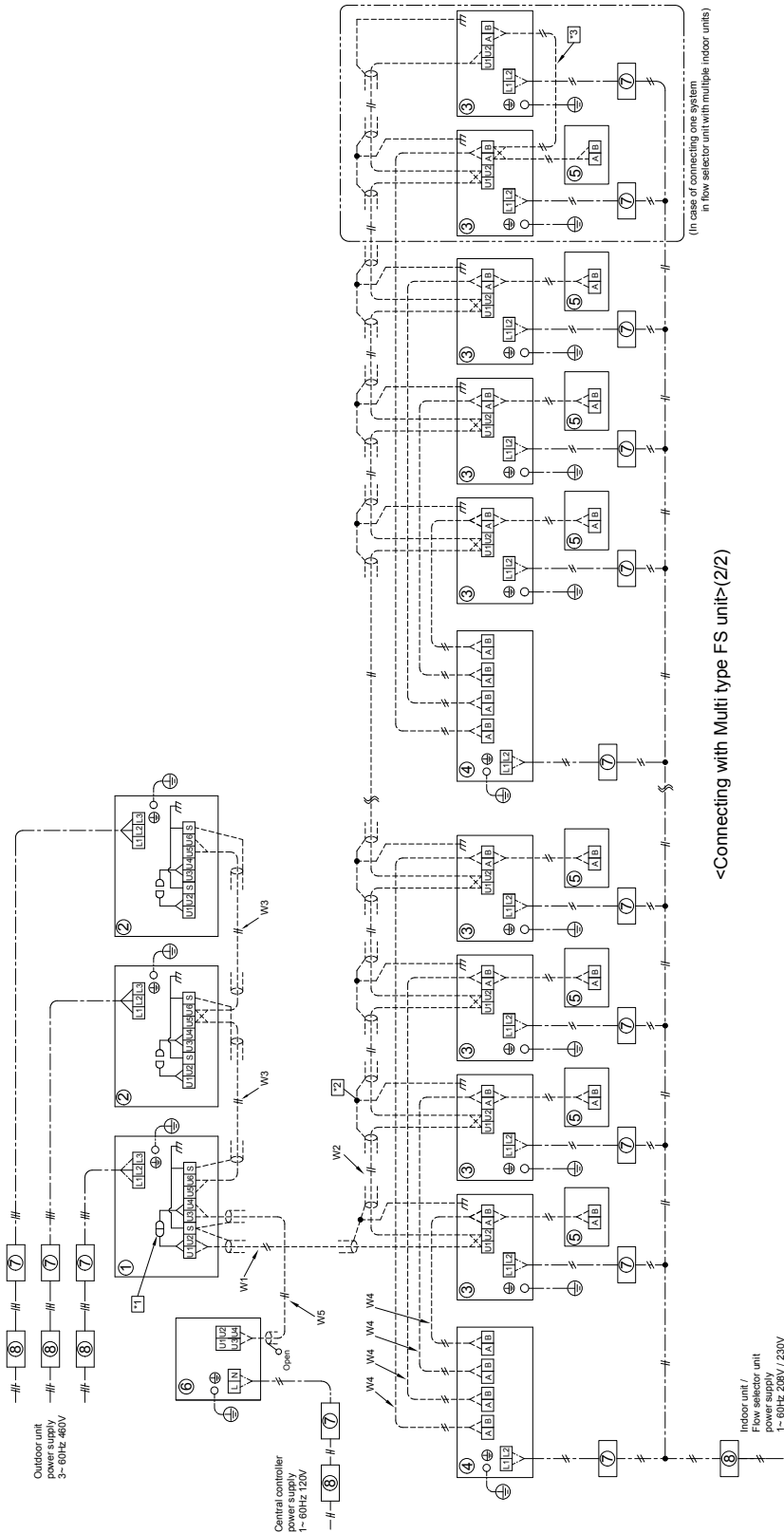

<Connecting with Multi type FS unit>(2/2)



Single Unit connecting with single type FS unit

Model : MMY-MAP***6FT9P-UL

- (Note)**
1. When using a central control, plug in the connector between [U1, U2] and [U3, U4] terminal of the header unit. (At shipment from factory, No connection)
 2. Connect the closed end terminal of shield wire. (Connected to all connecting sections in each unit)
 3. Group control.
 4. Power supply wiring to be per NEC and local codes.
 5. For the control wires connecting indoor units, outdoor units, and between indoor and outdoor units, use 2-core and non-polarity shield wires.
 6. For additional details, see the individual unit wiring diagrams. (Indoor & Outdoor)

①	Outdoor unit (Header unit)
②	Indoor unit
③	Flow selector unit (FS unit)
④	Remote controller
⑤	Central remote controller (option)
⑥	Disconnect switch for NEC
⑦	Circuit breaker

①	Shield wire
W1	Shielded control wiring between indoor and outdoor units
W2	Shielded control wiring between indoor unit
W3	Control wiring between indoor and flow selector units
W4	Shielded central control wiring

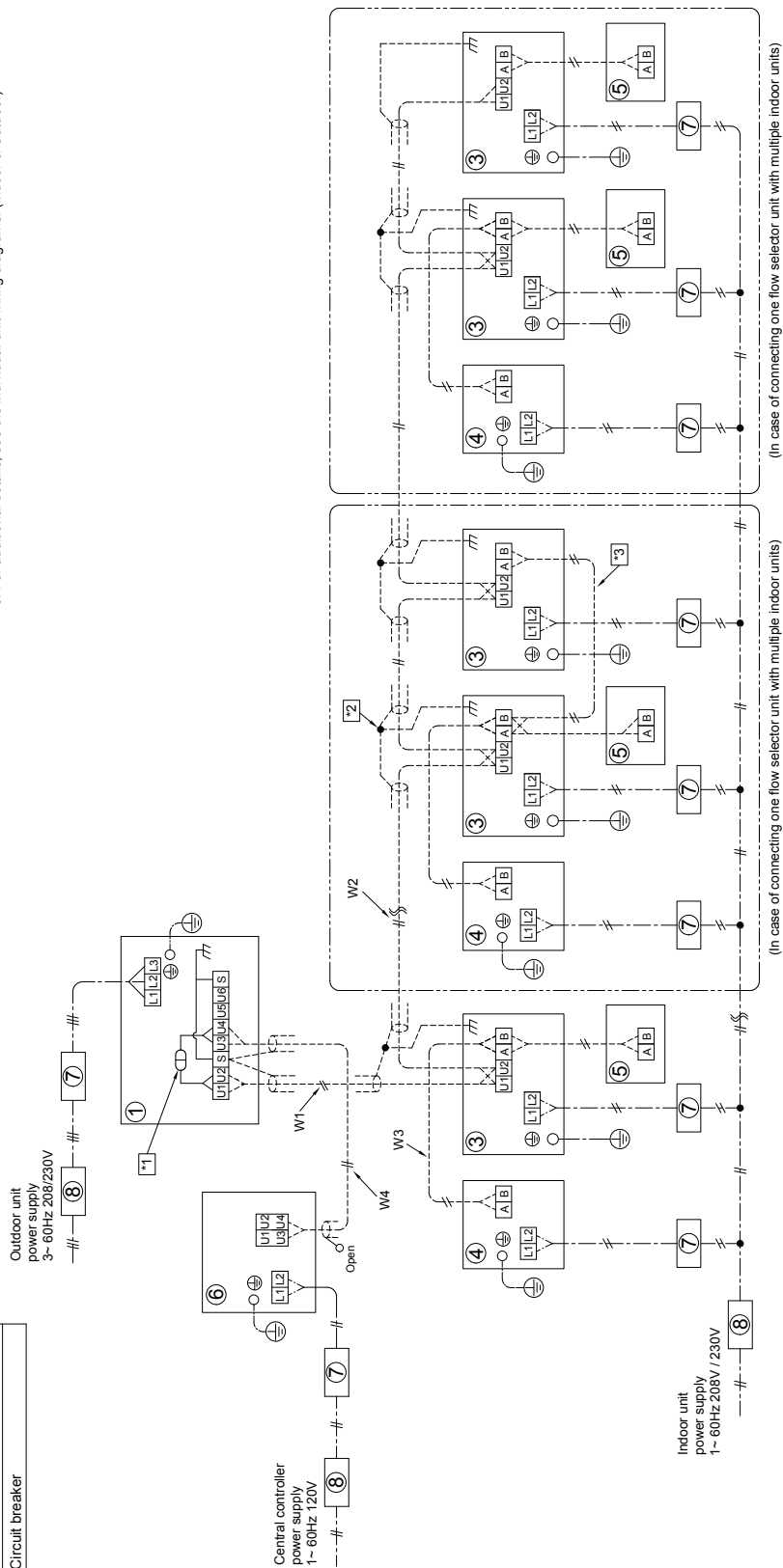

<Connecting with Single FS unit (Long piping mode)>

Single Unit connecting with multi type FS unit Model : MMY-MAP***6FT9P-UL

- (Note)
- When using a central control, plug in the connector between [U1,U2] and [U3,U4] terminal of the header unit.
 - Connect the shield of all control wiring to the ground screw on every unit. (Indoor & Outdoor)
 - Group control.
 - Power supply wiring to be per NEC and local codes.
 - For the control wires connecting indoor units, outdoor units, and between indoor and outdoor units, use 2-core shielded wires.
 - For additional details, see the individual unit wiring diagrams. (Indoor & Outdoor)

	Shield wire
W1	Shielded control wiring between indoor and outdoor units
W2	Shielded control wiring between indoor unit
W3	Control wiring between indoor and flow selector units
W4	Shielded central control wiring

①	Outdoor unit (Header unit)
②	—
③	Indoor unit
④	Flow selector unit (FS unit)
⑤	Remote controller
⑥	Central remote controller (option)
⑦	Disconnect switch for NEC
⑧	Circuit breaker

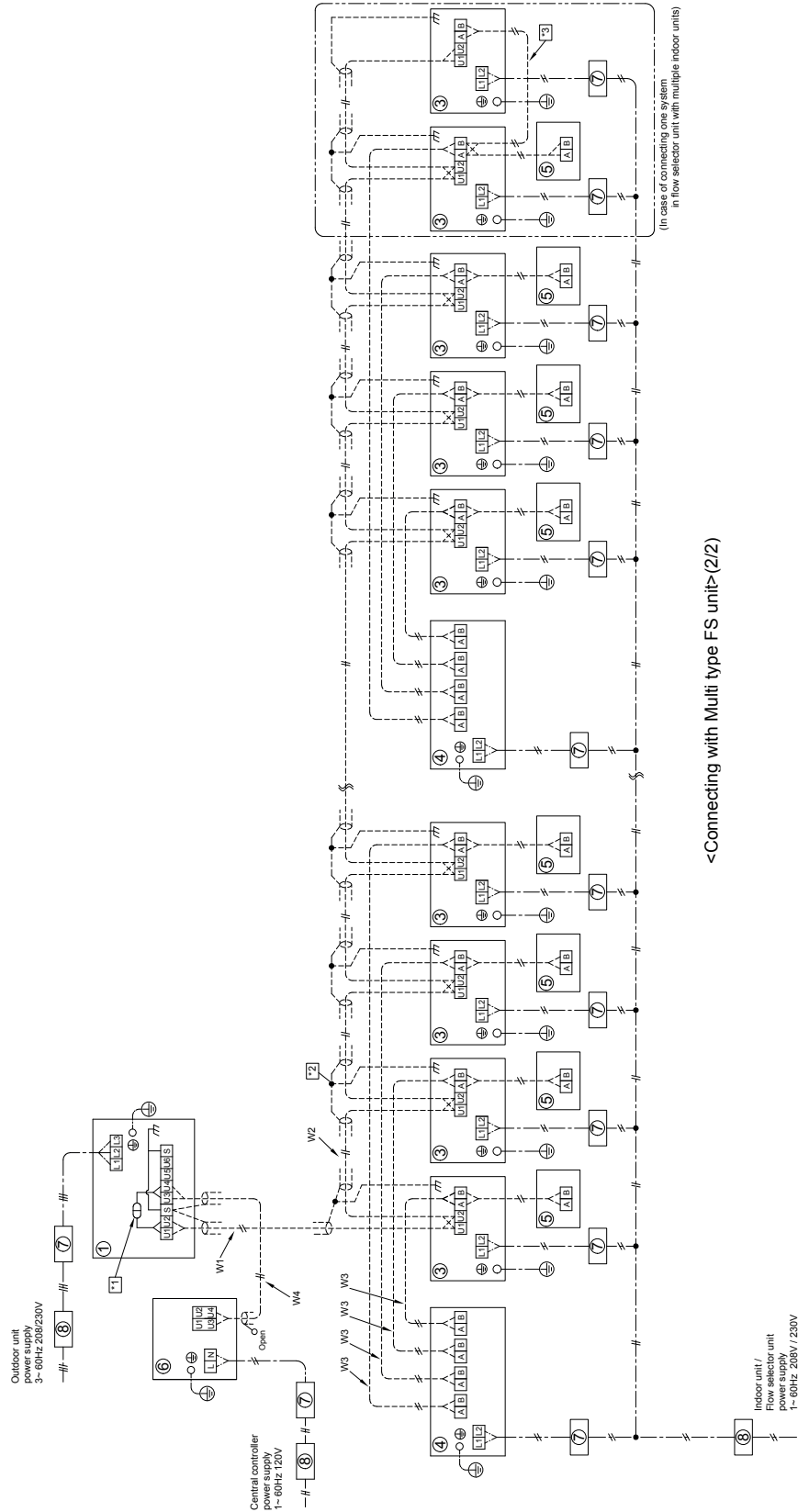

<Connecting with Multi type FS unit>(2/2)

Two Units connecting with single FS unit.

Model : MMY-AP***6FT9P-UL

(Note)

1. When using a central control, plug in the connector between [U1,U2] and [U3,U4] terminal of the header unit. (At shipment from factory : No connection)
2. Connect the closed end terminal of shield wire. (Connected to all connecting sections in each unit)
3. Group control.
4. Power supply wiring to be per NEC and local codes.
5. For the control wires connecting indoor units, outdoor units, and between indoor and outdoor units, use 2-core and non-polarity shield wires.
6. For additional details, see the individual Unit wiring diagrams. (Indoor & Outdoor)

Shield wire	
W1 :	Shielded control wiring between indoor and outdoor units
W2 :	Shielded control wiring between indoor unit
W3 :	Shielded control wiring between outdoor units
W4 :	Control wiring between indoor and flow selector units
W5 :	Shielded central control wiring

①	Outdoor unit (Header unit)
②	Outdoor unit (Follower unit)
③	Indoor unit
④	Flow selector unit (FS unit)
⑤	Remote controller
⑥	Central remote controller (option)
⑦	Disconnect switch for NEC
⑧	Circuit breaker

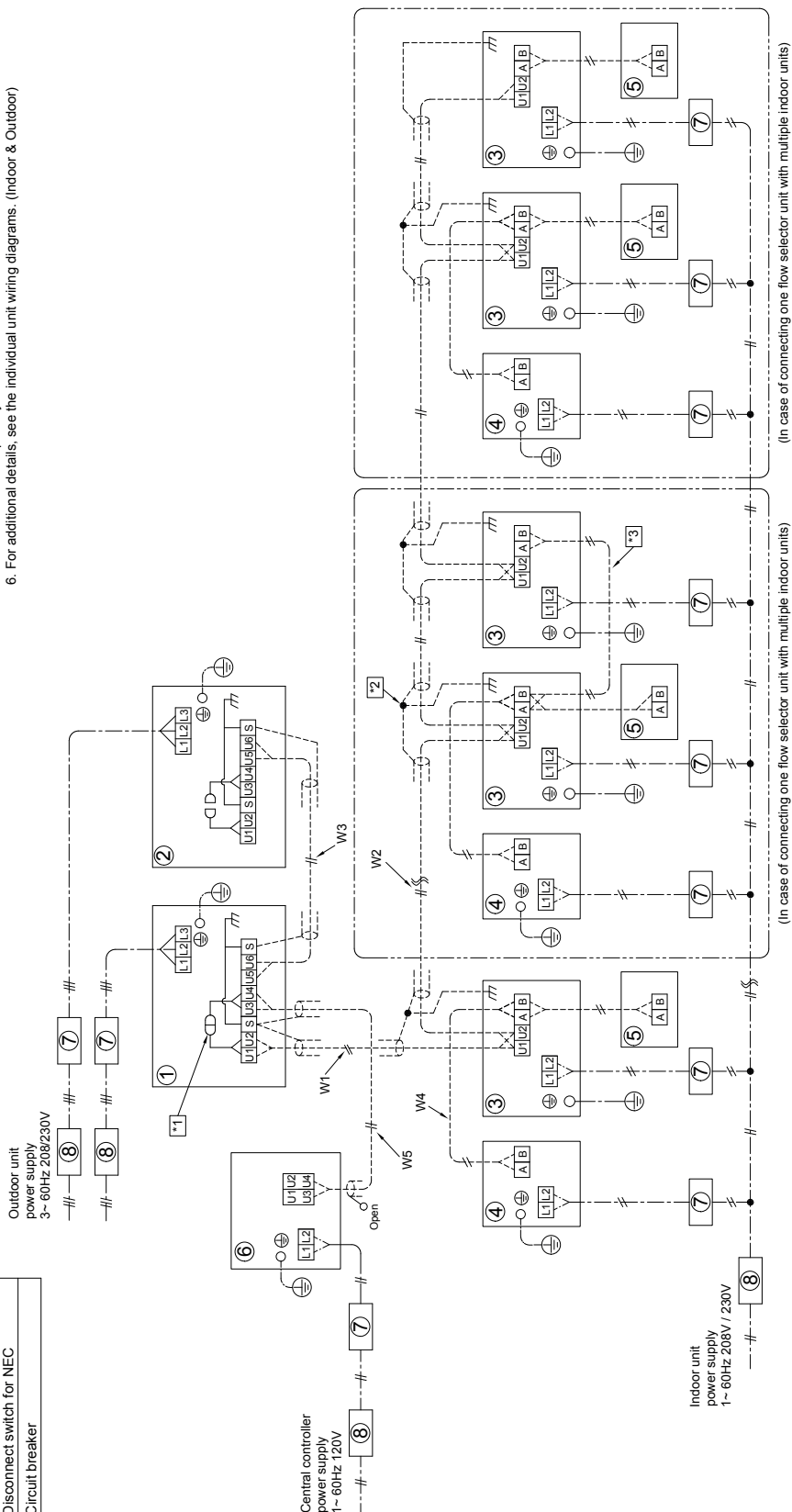

(In case of connecting one flow selector unit with multiple indoor units)

(In case of connecting one flow selector unit with multiple indoor units)

<Connecting with Single FS unit (Long piping model)>

Two Units connecting with multi type FS unit.

Model : MMY-AP***6FT9P-UL

(Note)

1. When using a central control, plug in the connector between [U1,U2] and [U3,U4] terminal of the header unit.
2. Connect the shield of all control wiring to the ground screw on every unit. (Indoor & Outdoor)
3. Group control.
4. Power supply wiring to be per NEC and local codes.
5. For the control wires connecting indoor units, outdoor units, and between indoor and outdoor units, use 2-core shielded wires.
6. For additional details, see the individual unit wiring diagrams (Indoor & Outdoor)

Shield wire	
W1	: Shielded control wiring between indoor and outdoor units
W2	: Shielded control wiring between indoor unit
W3	: Shielded control wiring between outdoor units
W4	: Control wiring between indoor and flow selector units
W5	: Shielded central control wiring

①	Outdoor unit (Header unit)
②	Outdoor unit (Follower unit)
③	Indoor unit
④	Flow selector unit (FS unit)
⑤	Remote controller
⑥	Central remote controller (option)
⑦	Disconnect switch for NEC
⑧	Circuit breaker

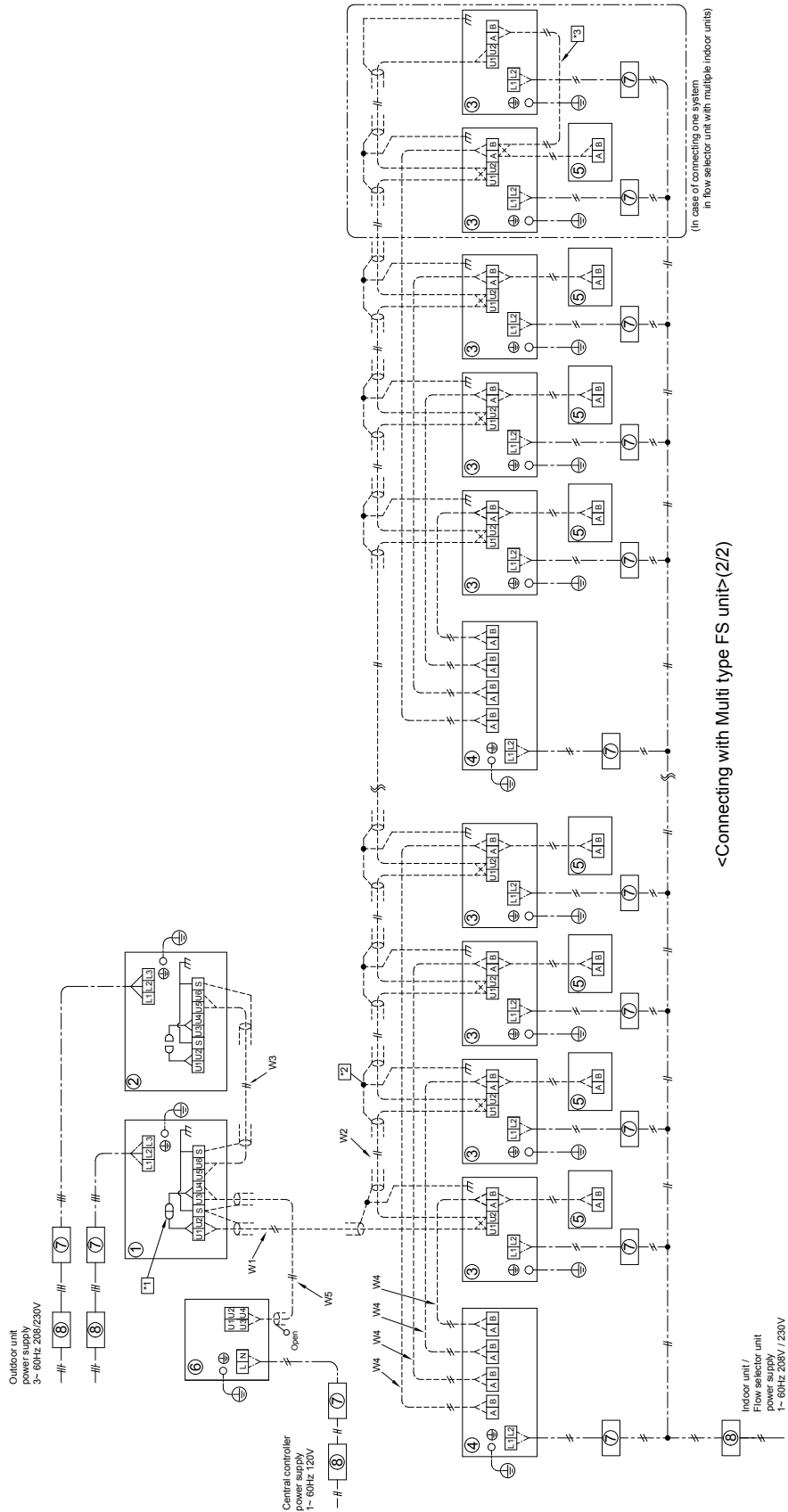

<Connecting with Multi type FS unit> (2/2)



Three Units connecting with single type FS unit.

Model : MMY-AP*6FT9P-UL**

- (Note)**
1. When using a central control, plug in the connector between [U1, U2] and [U3, U4] terminal of the header unit. (At shipment from factory : No connection)
 2. Connect the closed end terminal of shield wire. (Connected to all connecting sections in each unit)
 3. Group control.
 4. Power supply wiring to be per NEC and local codes.
 5. For the control wires connecting indoor units, outdoor units, and between indoor and outdoor units, use 2-core and non-polarity shield wires.
 6. For additional details, see the individual unit wiring diagrams. (Indoor & Outdoor)

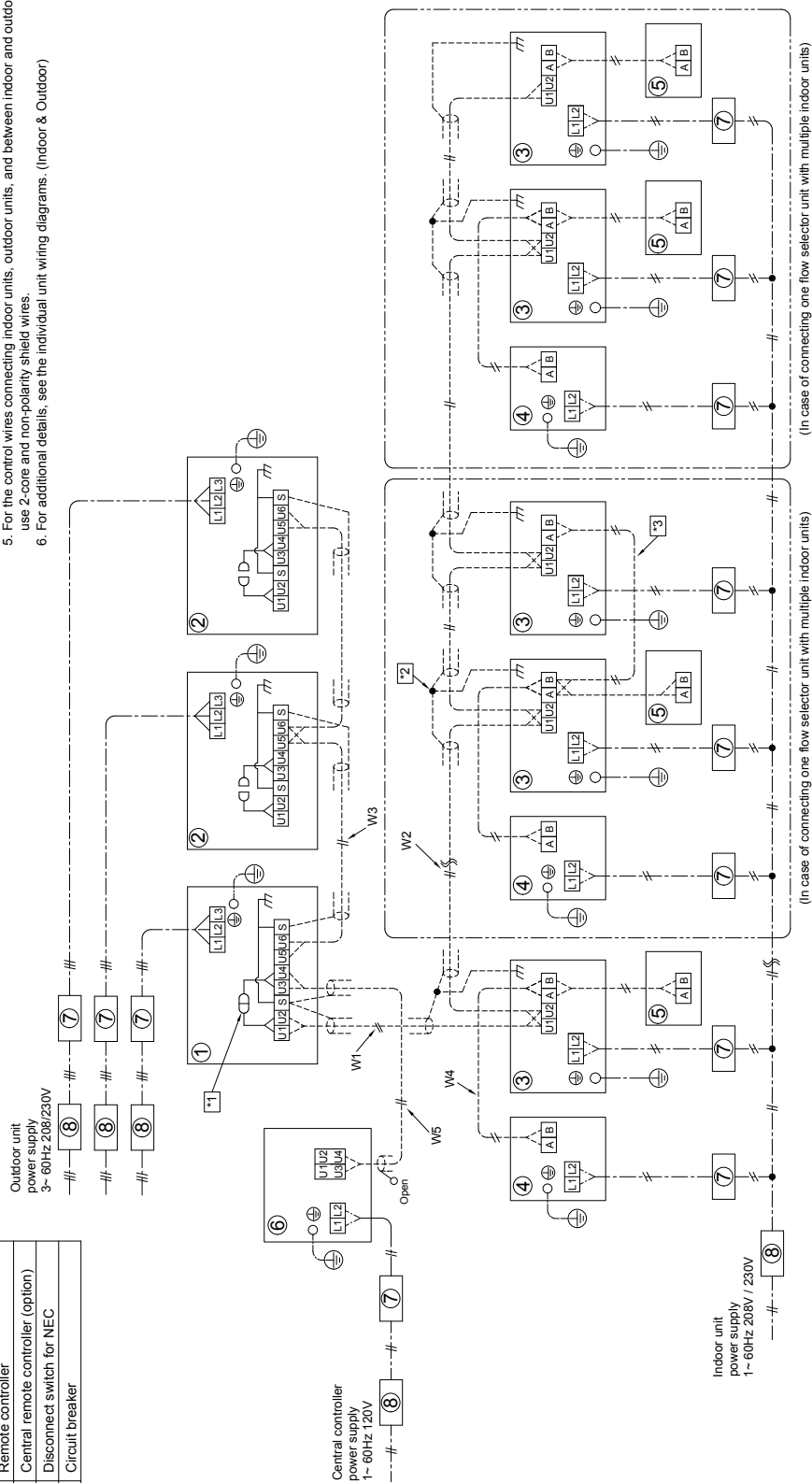

①	Outdoor unit (Header unit)
②	Outdoor unit (Follower unit)
③	Indoor unit
④	Flow selector unit (FS unit)
⑤	Remote controller
⑥	Central remote controller (option)
⑦	Disconnect switch for NEC
⑧	Circuit breaker

Shield wire
W1 : Shielded control wiring between indoor and outdoor units
W2 : Shielded control wiring between indoor unit
W3 : Shielded control wiring between outdoor units
W4 : Control wiring between indoor and flow selector units
W5 : Shielded central control wiring

<Connecting with Single FS unit (Long piping model)>

**Three Units connecting with multi type FS unit.
Model : MMY-AP***6FT9P-UL**

- (Note)**
- When using a central control, plug in the connector between [U1,U2] and [U3,U4] terminal of the header unit.
 - Connect the shield of all control wiring to the ground screw on every unit. (Indoor & Outdoor)
 - Group control.
 - Power supply wiring to be per NEC and local codes.
 - For the control wires connecting indoor units, outdoor units, and between indoor and outdoor units, use 2-core shielded wires.
 - For additional details, see the individual unit wiring diagrams (Indoor & Outdoor)

Shield wire	
W1	: Shielded control wiring between indoor and outdoor units
W2	: Shielded control wiring between indoor unit
W3	: Shielded control wiring between outdoor units
W4	: Control wiring between indoor and flow selector units
W5	: Shielded central control wiring

①	Outdoor unit (Header unit)
②	Outdoor unit (Follower unit)
③	Indoor unit
④	Flow selector unit (FS unit)
⑤	Remote controller
⑥	Central remote controller (option)
⑦	Disconnect switch for NEC
⑧	Circuit breaker

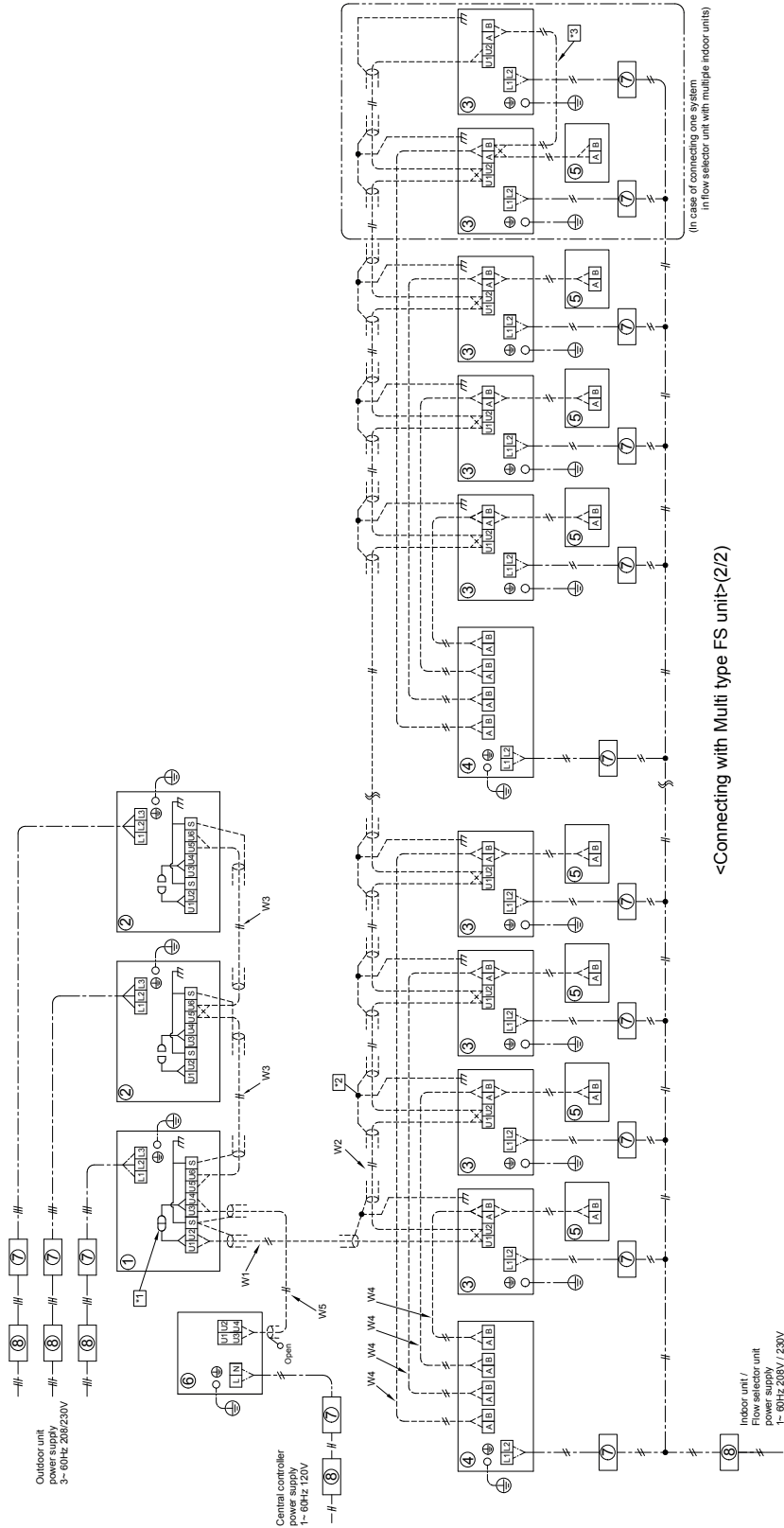

Single Unit connecting with single type FS unit Model : MMY-MAP***6FT2P-UL

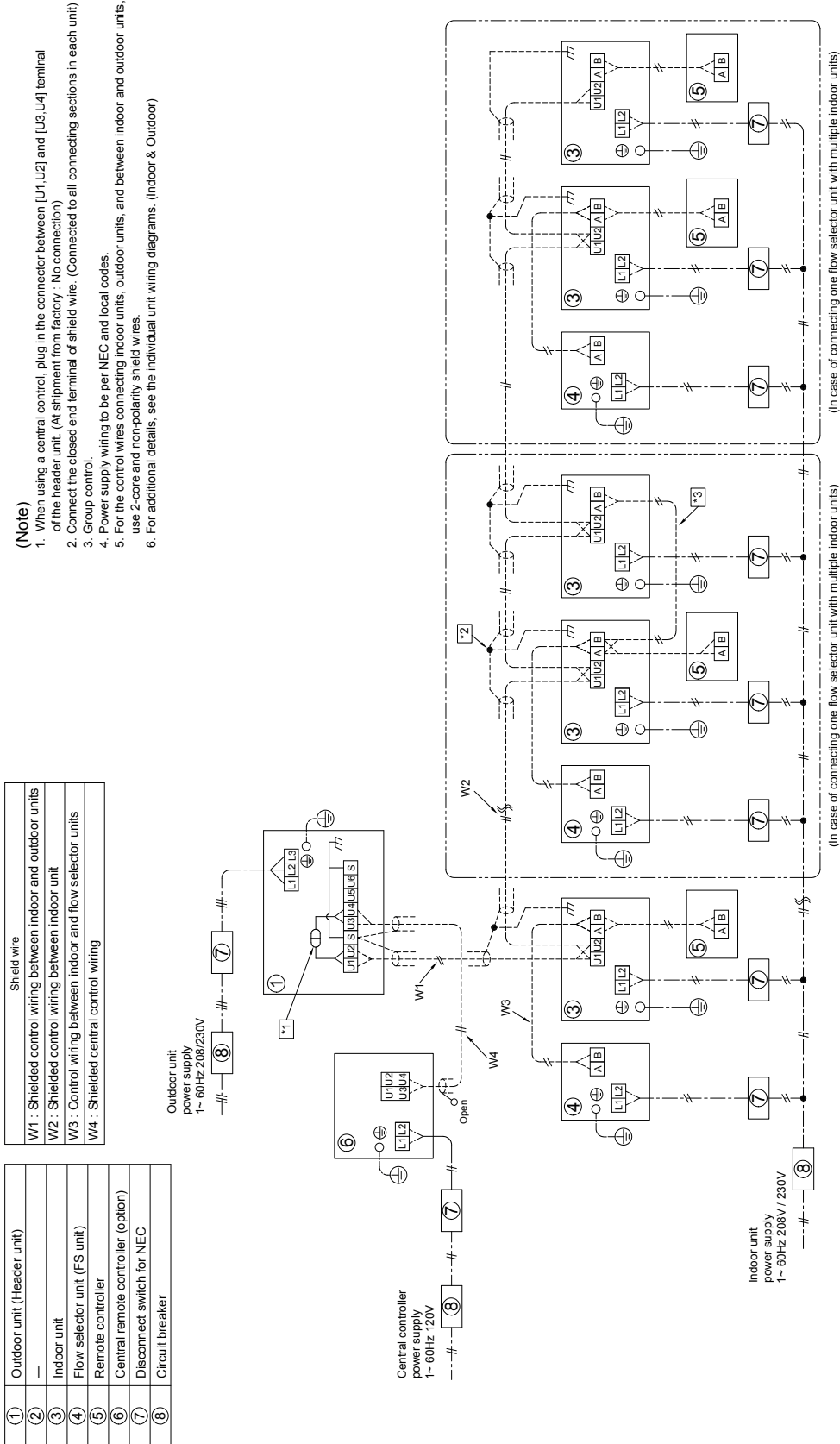

<Connecting with Single FS unit (Long piping model)>

Single Unit connecting with multi type FS unit Model : MMY-MAP0726FT2P-UL

- (Note)**
- When using a central control, plug in the connector between [U1, U2] and [U3, U4] terminal of the header unit. (At shipment from factory : No connection)
 - Connect the closed end terminal of shield wire. (Connected to all connecting sections in each unit)
 - Group control.
 - Power supply wiring to be per NEC and local codes.
 - For the control wires connecting indoor units, outdoor units, and between indoor and outdoor units, use 2-core and non-polarity shield wires.
 - For additional details, see the individual unit wiring diagrams. (Indoor & Outdoor)

Shield wire	
W1	: Shielded control wiring between indoor and outdoor units
W2	: Shielded control wiring between indoor unit
W3	: Control wiring between indoor and flow selector units
W4	: Shielded central control wiring

①	Outdoor unit (Header unit)
②	Indoor unit
③	Flow selector unit (FS unit)
④	Remote controller
⑤	Central remote controller (option)
⑥	Disconnect switch for NEC
⑦	Circuit breaker

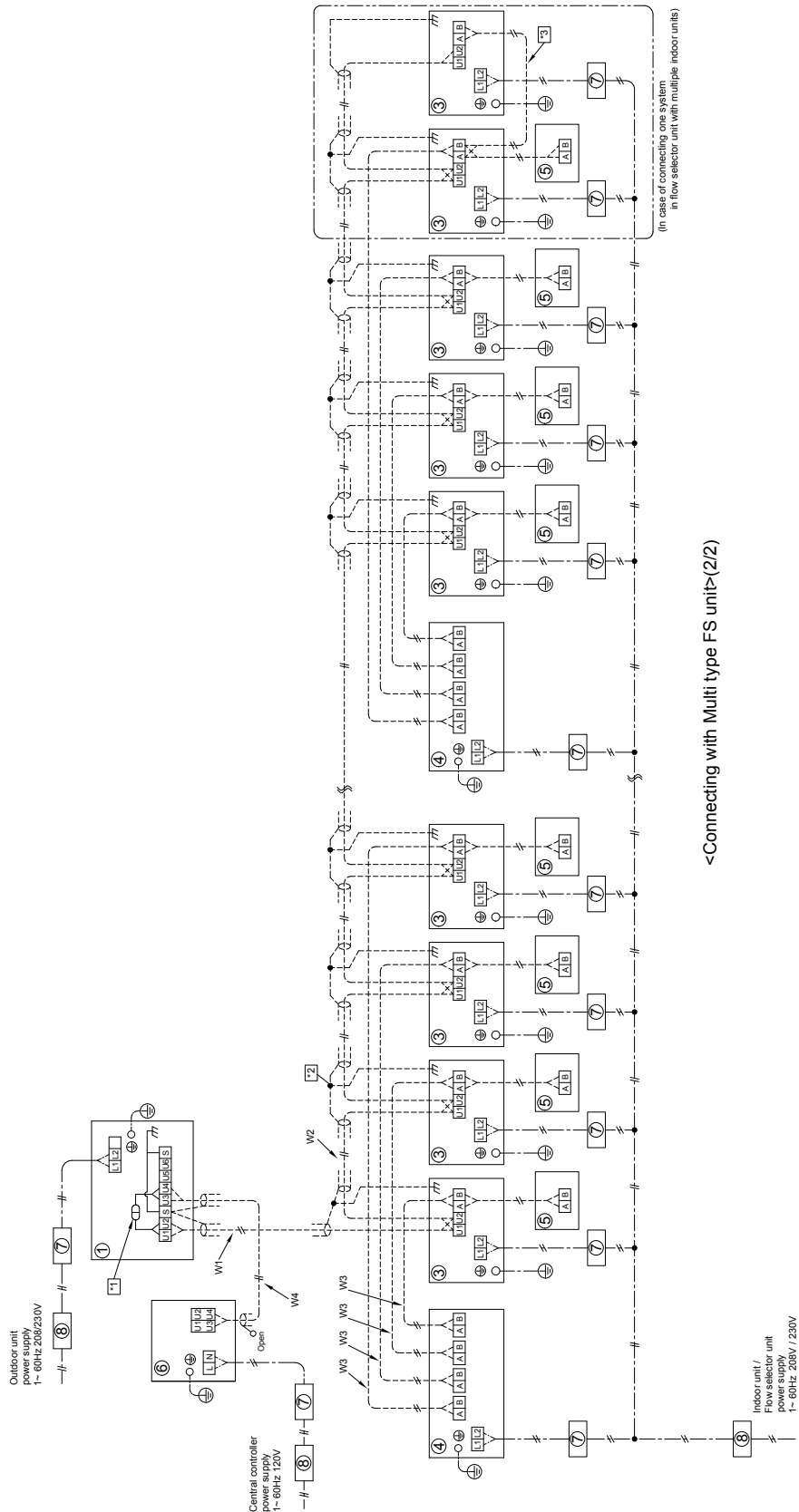

<Connecting with Multi type FS unit>(2/2)

Two Unit connecting with single type FS unit
Model : MMY-AP1446FT2P-UL

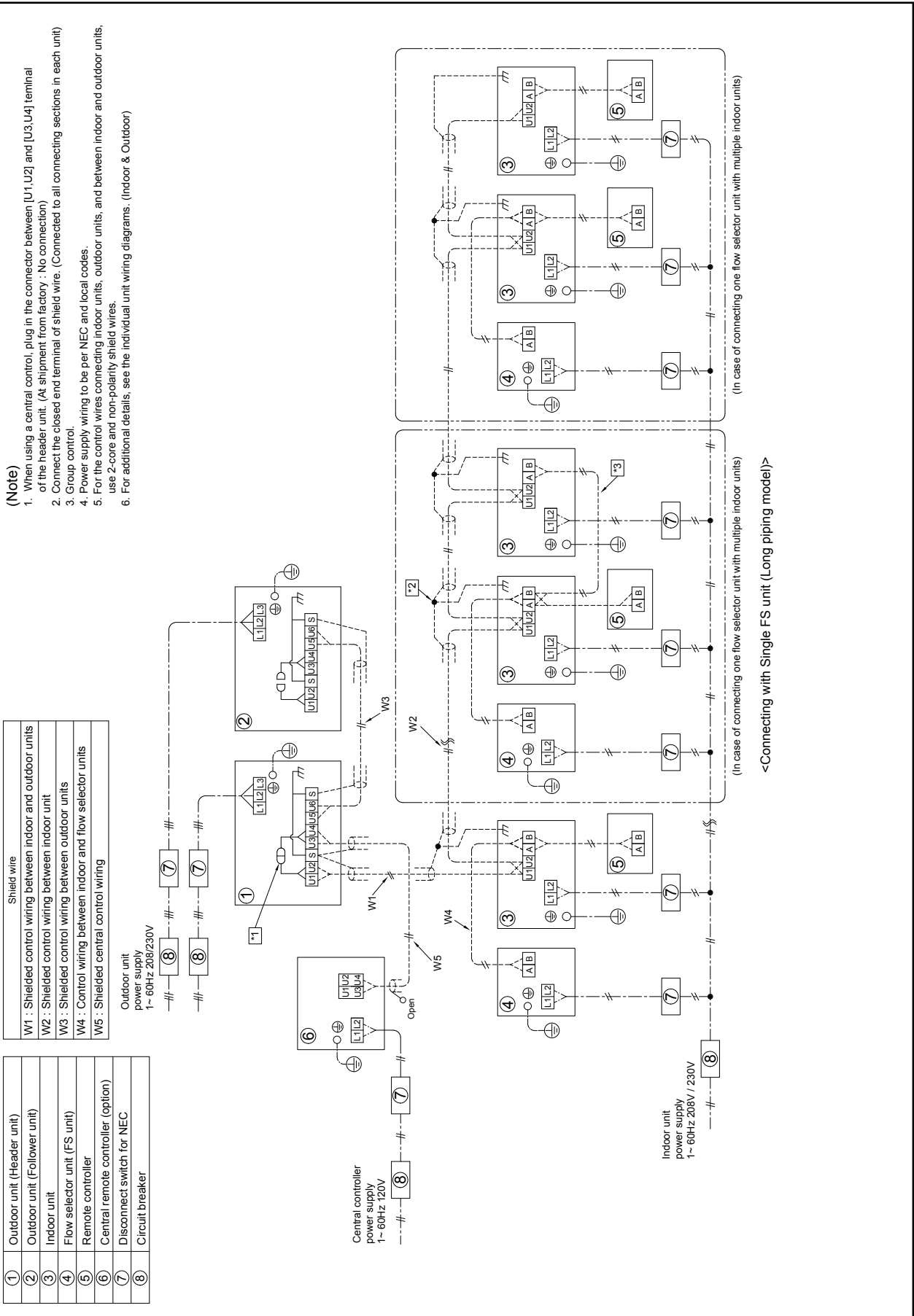

Two Unit connecting with multi type FS unit
Model : MMY-AP1446FT2P-UL

(Note)

1. When using a central control, plug in the connector between [U1,U2] and [U3,U4] terminal of the header unit. (At shipment from factory : No connection)
2. Connect the closed end terminal of shield wire. (Connected to all connecting sections in each unit)
3. Group control.
4. Power supply wiring to be per NEC and local codes.
5. For the control wires connecting indoor units, outdoor units, and between indoor and outdoor units, use 2-core and non-polarity shield wires.
6. For additional details, see the individual unit wiring diagrams. (Indoor & Outdoor)

Shield wire	
W1	: Shielded control wiring between indoor and outdoor units
W2	: Shielded control wiring between indoor unit
W3	: Shielded control wiring between outdoor units
W4	: Control wiring between indoor and flow selector units
W5	: Shielded central control wiring

①	Outdoor unit (Header unit)
②	Outdoor unit (Follower unit)
③	Indoor unit
④	Flow selector unit (FS unit)
⑤	Remote controller
⑥	Central remote controller (option)
⑦	Disconnect switch for NEC
⑧	Circuit breaker

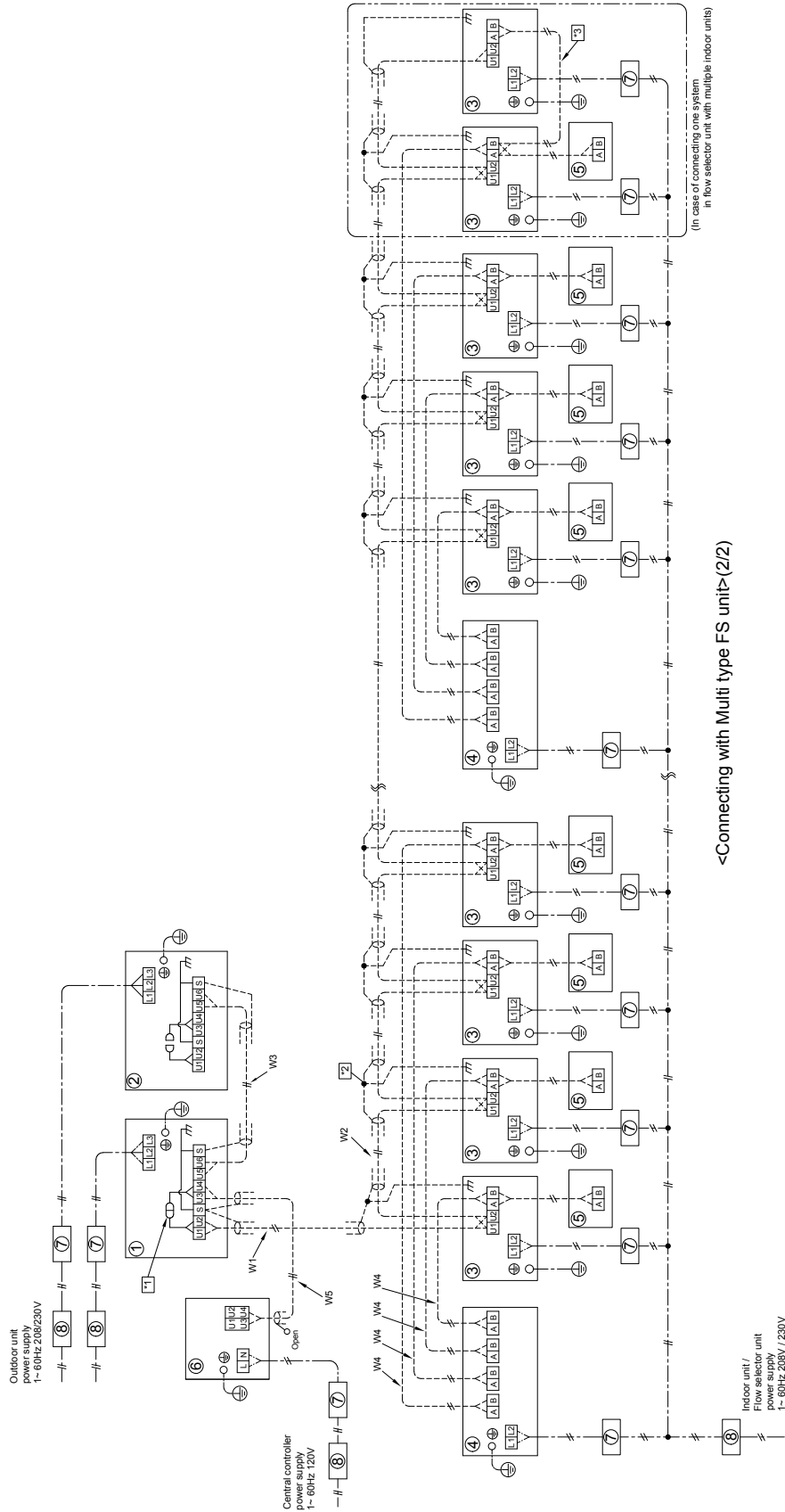



5-8. Applied control for Outdoor Unit

5-8-1. MMY-MAP__6FT6P-UL / MMY-MAP__6FT9P-UL

The outdoor fan high static pressure support and priority operation mode setting (cooling / heating / number of units / or priority indoor unit) functions are made available by setting relevant switches provided on the interface P.C. board of the outdoor unit.

5-8-1-1. Outdoor Fan High Static Pressure Shift

Purpose/characteristics

This function is used when connecting a duct to the discharge port of an outdoor unit (as part of, for example, unit installation on the floor by floor installation.)

Setup

Turn ON the DIP switch [SW10, Bit 2] provided on the interface P.C. board of the outdoor unit.

This function must be enabled with every discharge duct connected outdoor unit for both of the header and follower units.

Specification

Increase the speed of the propeller fan units on the outdoor fan to allow the installation of a duct with a maximum external static pressure not greater than specified in the table below. If a discharge duct with a resistance greater than 0.06 inWG (1.5 mmAq) is to be used, enable this function. The maximum external static pressures of base units are shown below (Table 1). In the case of combined use of multiple outdoor units, set all the units to the same maximum external static pressure as the one with the lowest maximum external static pressure (see Table 2).

(Table 1.) Maximum external static pressures of base outdoor units

Model name	Maximum external static pressure (inWG)	(*) Outdoor unit air flow (CFM)
MMY-MAP0726FT6P-UL MMY-MAP0726FT9P-UL	0.24	5900
MMY-MAP0966FT6P-UL MMY-MAP0966FT9P-UL	0.16	7480
MMY-MAP1206FT6P-UL MMY-MAP1206FT9P-UL	0.16	7700
MMY-MAP1446FT6P-UL MMY-MAP1446FT9P-UL	0.16	10850
MMY-MAP1686FT6P-UL MMY-MAP1686FT9P-UL	0.16	10850

(*) Calculate duct resistance from outdoor unit air flow

(Table 2.) Maximum external static pressures for combined use of base unit

Outdoor unit capacity type	Combination			Maximum external static pressure (inWG)
	Header outdoor unit	Follower outdoor unit1	Follower outdoor unit2	
072 type	072 type	-	-	Standard Model 0.24
096 type	096 type	-	-	Standard Model 0.16
120 type	120 type	-	-	Standard Model 0.16
144 type	144 type	-	-	Standard Model 0.16
168 type	168 type	-	-	Standard Model 0.16
192 type	096 type	096 type	-	Standard Model 0.16
	120 type	072 type	-	Space Saving Model 0.16
216 type	120 type	096 type	-	Standard Model 0.16
240 type	144 type	096 type	-	Standard Model 0.16
	120 type	120 type	-	Space Saving Model 0.16
264 type	144 type	120 type	-	Standard Model 0.16
288 type	144 type	144 type	-	Standard Model 0.16
	168 type	120 type	-	Space Saving Model 0.16
312 type	168 type	144 type	-	Standard Model 0.16
336 type	120 type	120 type	096 type	Standard Model 0.16
360 type	120 type	120 type	120 type	Standard Model 0.16
384 type	144 type	120 type	120 type	Standard Model 0.16
408 type	144 type	144 type	120 type	Standard Model 0.16
432 type	144 type	144 type	144 type	Standard Model 0.16
456 type	168 type	144 type	144 type	Standard Model 0.16



5-8-2. MMY-MAP__6FT2P-UL

The outdoor fan high static pressure support and priority operation mode setting (cooling / heating / number of units / or priority indoor unit) functions are made available by setting relevant switches provided on the interface P.C. board of the outdoor unit.

5-8-2-1. Outdoor Fan High Static Pressure Shift

Purpose/characteristics

This function is used when connecting a duct to the discharge port of an outdoor unit (as part of, for example, unit installation on the floor by floor installation.)

Setup

Turn ON the DIP switch [SW10, Bit 2] provided on the interface P.C. board of the outdoor unit.

This function must be enabled with every discharge duct connected outdoor unit for both of the header and follower units.

Specification

Increase the speed of the propeller fan units on the outdoor fan to allow the installation of a duct with a maximum external static pressure not greater than specified in the table below. If a discharge duct with a resistance greater than 0.06 inWG (1.5 mmAq) is to be used, enable this function. The maximum external static pressures of base units are shown below (Table 1). In the case of combined use of multiple outdoor units, set all the units to the same maximum external static pressure as the one with the lowest maximum external static pressure (see Table 2).

(Table 1.) Maximum external static pressures of base outdoor units



Model name	Maximum external static pressure (inWG)	(*) Outdoor unit air flow (CFM)
MMY-MAP0726FT2P-UL	0.24	5900



(*) Calculate duct resistance from outdoor unit air flow

(Table 2.) Maximum external static pressures for combined use of base unit

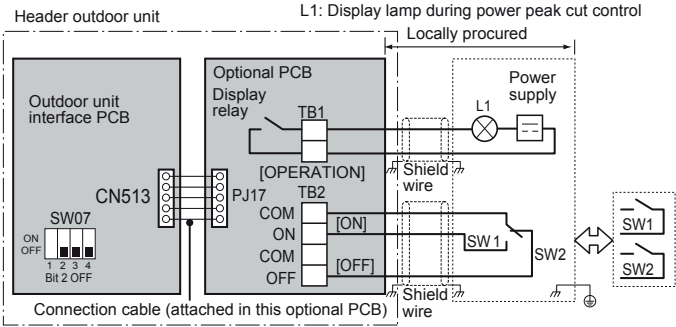
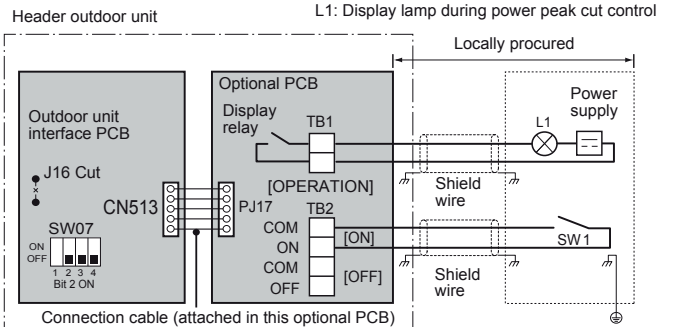

Outdoor unit capacity type	Combination		Standard Model	Maximum external static pressure (inWG)
	Header outdoor unit	Follower outdoor unit1		
072 type	072 type	-	Standard Model	0.24
144 type	072 type	072 type	Standard Model	0.24

5-9. Optional printed board (PCB) of outdoor unit

Model name	Appearance	Function																																			
TCB-PCDM4UL	<div style="text-align: center;">  <p>Size: 2.80 × 3.35 (in)</p> <p>Application</p>  <p>* Install the optional PCB in the inverter assembly of the outdoor header unit.</p> </div>	<p>Power peak-cut Control Standard Specifications (Wiring example)</p>  <p>Header outdoor unit L1: Display lamp during power peak cut control Locally procured</p> <p>Outdoor unit interface PCB Optional PCB Display relay TB1 [OPERATION] PJ17 TB2 COM ON [ON] COM OFF [OFF]</p> <p>SW07 ON OFF 1 2 3 4 Bit 2 OFF</p> <p>Connection cable (attached in this optional PCB)</p> <p>Power supply L1</p> <p>Shield wire</p> <p>SW1 SW2</p> <p>For SW1 and SW2, be sure to provide no-voltage contacts for each terminal. The input signals of SW1 and SW2 may be pulse input (100 msec or more) or continuous make. Do not turn on [SW1] and [SW2] simultaneously.</p> <p><SW07 (bit 2) OFF [2-stage switching]></p> <table border="1" data-bbox="678 1030 1364 1187"> <thead> <tr> <th colspan="2">Input</th> <th colspan="2">SW07 (bit 1)</th> <th rowspan="2">Display relay (L1)</th> </tr> <tr> <th>SW1</th> <th>SW2</th> <th>Bit 1 OFF</th> <th>Bit 1 ON</th> </tr> </thead> <tbody> <tr> <td>OFF</td> <td>ON</td> <td>100% (normal operation)</td> <td>100% (normal operation)</td> <td>OFF</td> </tr> <tr> <td>ON</td> <td>OFF</td> <td>0% (forced stop)</td> <td>Approx. 60% (upper limit regulated)</td> <td>ON</td> </tr> </tbody> </table> <p>For one input function</p> <p>Power peak-cut ON-OFF control is made possible on SMMS-e and SHRM-e on the [ON]terminal input (SW1) by cutting the jumper lead(J16) of the center outdoor unit interface PCB. (Wiring example)</p>  <p>Header outdoor unit L1: Display lamp during power peak cut control Locally procured</p> <p>Outdoor unit interface PCB Optional PCB Display relay TB1 [OPERATION] PJ17 TB2 COM ON [ON] COM OFF [OFF]</p> <p>SW07 ON OFF 1 2 3 4 Bit 2 ON</p> <p>J16 Cut</p> <p>Connection cable (attached in this optional PCB)</p> <p>Power supply L1</p> <p>Shield wire</p> <p>SW1</p> <p><SW07 (bit 2) OFF [2-stage switching]></p> <p>Power peak-cut control turns ON when SW1 in the wiring example is ON (continuous make).</p> <table border="1" data-bbox="678 1881 1364 2049"> <thead> <tr> <th rowspan="2">Jumper lead J16</th> <th rowspan="2">Input SW1</th> <th colspan="2">SW07 (bit 1)</th> <th rowspan="2">Display relay (L1)</th> </tr> <tr> <th>Bit 1 OFF</th> <th>Bit 1 ON</th> </tr> </thead> <tbody> <tr> <td rowspan="2">Cut</td> <td>OFF</td> <td>100% (normal operation)</td> <td>100% (normal operation)</td> <td>OFF</td> </tr> <tr> <td>ON</td> <td>0% (forced stop)</td> <td>Approx. 60% (upper limit regulated)</td> <td>ON</td> </tr> </tbody> </table>	Input		SW07 (bit 1)		Display relay (L1)	SW1	SW2	Bit 1 OFF	Bit 1 ON	OFF	ON	100% (normal operation)	100% (normal operation)	OFF	ON	OFF	0% (forced stop)	Approx. 60% (upper limit regulated)	ON	Jumper lead J16	Input SW1	SW07 (bit 1)		Display relay (L1)	Bit 1 OFF	Bit 1 ON	Cut	OFF	100% (normal operation)	100% (normal operation)	OFF	ON	0% (forced stop)	Approx. 60% (upper limit regulated)	ON
Input		SW07 (bit 1)		Display relay (L1)																																	
SW1	SW2	Bit 1 OFF	Bit 1 ON																																		
OFF	ON	100% (normal operation)	100% (normal operation)	OFF																																	
ON	OFF	0% (forced stop)	Approx. 60% (upper limit regulated)	ON																																	
Jumper lead J16	Input SW1	SW07 (bit 1)		Display relay (L1)																																	
		Bit 1 OFF	Bit 1 ON																																		
Cut	OFF	100% (normal operation)	100% (normal operation)	OFF																																	
	ON	0% (forced stop)	Approx. 60% (upper limit regulated)	ON																																	

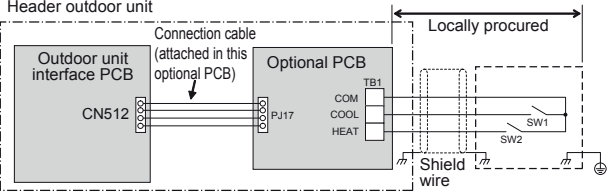
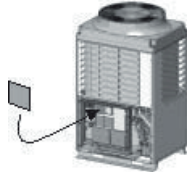
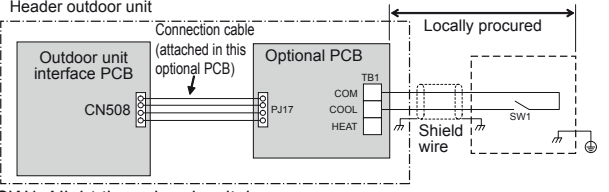

Model name	Appearance	Function																												
TCB-PCDM4UL	 <p>Size: 2.80 × 3.35 (in)</p> <p>Application</p>	<p>Enhanced Specifications (Wiring example)</p> <p>Header outdoor unit</p> <p>L1: Display lamp during power peak cut control</p> <p>Locally procured</p> <p>Outdoor unit interface PCB</p> <p>Optional PCB</p> <p>Display relay</p> <p>TB1</p> <p>[OPERATION]</p> <p>PJ17</p> <p>TB2</p> <p>COM [ON]</p> <p>COM [OFF]</p> <p>SW1</p> <p>SW2</p> <p>Shield wire</p> <p>Shield wire</p> <p>Power supply</p> <p>L1</p> <p>For SW1 and SW2, be sure to provide no-voltage contacts for each terminal.</p> <p>Connection cable (attached in this optional PCB)</p>																												
	 <p>* Install the optional PCB in the inverter assembly of the outdoor header unit.</p>	<p><SW07 (bit 2) ON [4-stage switching]></p> <table border="1" data-bbox="700 943 1390 1200"> <thead> <tr> <th colspan="2">Input</th> <th colspan="2">SW07 (bit 1)</th> <th rowspan="2">Display relay (L1)</th> </tr> <tr> <th>SW1</th> <th>SW2</th> <th>Bit 1 OFF</th> <th>Bit 1 ON</th> </tr> </thead> <tbody> <tr> <td>OFF</td> <td>OFF</td> <td>100% (normal operation)</td> <td>100% (normal operation)</td> <td>OFF</td> </tr> <tr> <td>ON</td> <td>OFF</td> <td>Approx. 80% (upper limit regulated)</td> <td>Approx. 85% (upper limit regulated)</td> <td>ON</td> </tr> <tr> <td>OFF</td> <td>ON</td> <td>Approx. 60% (upper limit regulated)</td> <td>Approx. 75% (upper limit regulated)</td> <td>ON</td> </tr> <tr> <td>ON</td> <td>ON</td> <td>0% (forced stop)</td> <td>Approx. 60% (upper limit regulated)</td> <td>ON</td> </tr> </tbody> </table>	Input		SW07 (bit 1)		Display relay (L1)	SW1	SW2	Bit 1 OFF	Bit 1 ON	OFF	OFF	100% (normal operation)	100% (normal operation)	OFF	ON	OFF	Approx. 80% (upper limit regulated)	Approx. 85% (upper limit regulated)	ON	OFF	ON	Approx. 60% (upper limit regulated)	Approx. 75% (upper limit regulated)	ON	ON	ON	0% (forced stop)	Approx. 60% (upper limit regulated)
Input		SW07 (bit 1)		Display relay (L1)																										
SW1	SW2	Bit 1 OFF	Bit 1 ON																											
OFF	OFF	100% (normal operation)	100% (normal operation)	OFF																										
ON	OFF	Approx. 80% (upper limit regulated)	Approx. 85% (upper limit regulated)	ON																										
OFF	ON	Approx. 60% (upper limit regulated)	Approx. 75% (upper limit regulated)	ON																										
ON	ON	0% (forced stop)	Approx. 60% (upper limit regulated)	ON																										

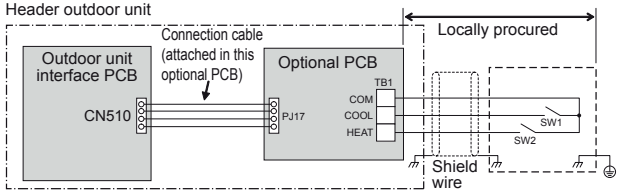
Model name	Appearance	Function																																	
TCB-PCMO4JUL	 <p>Size: 2.19 × 2.35 (in)</p>	<p>[1] External master ON/OFF control</p> <p>▼ Function By connecting the cable (attached in this optional PCB) to the interface PC board on an outdoor unit, all indoor units connected to the outdoor unit enable to operate simultaneously.</p> <p>▼ Operation The outdoor unit connection is for the header unit (U1).</p>  <p>SW1: Operation input switch SW2: Stop input switch</p> <table border="1" data-bbox="703 815 1398 949"> <thead> <tr> <th>Terminal</th> <th>Input Signal</th> <th>Operation</th> </tr> </thead> <tbody> <tr> <td>COOL (SW1)</td> <td>ON OFF </td> <td>All indoor units operate together</td> </tr> <tr> <td>HEAT (SW2)</td> <td>ON OFF </td> <td>All indoor units stop together</td> </tr> </tbody> </table> <p>Provide no-voltage pulse contacts for each terminal. Hold the ON state for at least 100 msec. Do not turn SW1 and SW2 ON simultaneously</p>	Terminal	Input Signal	Operation	COOL (SW1)	ON OFF	All indoor units operate together	HEAT (SW2)	ON OFF	All indoor units stop together																								
	Terminal	Input Signal	Operation																																
	COOL (SW1)	ON OFF	All indoor units operate together																																
HEAT (SW2)	ON OFF	All indoor units stop together																																	
<p>Application</p>  <p>* Install the optional PCB in the inverter assembly of the outdoor header unit.</p>	<p>[2] Night time operation (sound reduction) control</p> <p>▼ Function As the cable (attached in this optional PCB) is connected to the "Interface PCB" on an outdoor unit, both compressor speed and fan speed are restricted while the signal of the night operation control is input. It makes the noise reduction during the night time operation.</p> <p>▼ Operation The outdoor unit connection is for the header unit (U1).</p>  <p>SW1: Night time signal switch</p> <table border="1" data-bbox="703 1532 1382 1666"> <thead> <tr> <th>Terminal</th> <th>Input Signal</th> <th>Operation</th> </tr> </thead> <tbody> <tr> <td rowspan="2">COOL (SW1)</td> <td>ON OFF </td> <td>Night time operation control</td> </tr> <tr> <td>ON OFF </td> <td>Normal operation</td> </tr> </tbody> </table> <p>Each terminal should be connected to dry contact.</p> <p>▼ Sound reduction and approximation capacity (reference)</p> <table border="1" data-bbox="703 1749 1449 1962"> <thead> <tr> <th rowspan="2">Outdoor unit (base unit)</th> <th rowspan="2">During low noise mode dB(A)</th> <th colspan="2">Capacity</th> </tr> <tr> <th>Cooling</th> <th>Heating</th> </tr> </thead> <tbody> <tr> <td>072 type</td> <td>50</td> <td>Approx. 85%</td> <td>Approx. 80%</td> </tr> <tr> <td>096 type</td> <td>53</td> <td>Approx. 85%</td> <td>Approx. 85%</td> </tr> <tr> <td>120 type</td> <td>53</td> <td>Approx. 80%</td> <td>Approx. 80%</td> </tr> <tr> <td>144 type</td> <td>54</td> <td>Approx. 70%</td> <td>Approx. 70%</td> </tr> <tr> <td>168 type</td> <td>54</td> <td>Approx. 65%</td> <td>Approx. 65%</td> </tr> </tbody> </table> <p>* Position of noise measuring device: 3.3 ft (1 m) from the front face of the set and 4.9 ft (1.5 m) above ground (anechoic sound)</p>	Terminal	Input Signal	Operation	COOL (SW1)	ON OFF	Night time operation control	ON OFF	Normal operation	Outdoor unit (base unit)	During low noise mode dB(A)	Capacity		Cooling	Heating	072 type	50	Approx. 85%	Approx. 80%	096 type	53	Approx. 85%	Approx. 85%	120 type	53	Approx. 80%	Approx. 80%	144 type	54	Approx. 70%	Approx. 70%	168 type	54	Approx. 65%	Approx. 65%
Terminal	Input Signal	Operation																																	
COOL (SW1)	ON OFF	Night time operation control																																	
	ON OFF	Normal operation																																	
Outdoor unit (base unit)	During low noise mode dB(A)	Capacity																																	
		Cooling	Heating																																
072 type	50	Approx. 85%	Approx. 80%																																
096 type	53	Approx. 85%	Approx. 85%																																
120 type	53	Approx. 80%	Approx. 80%																																
144 type	54	Approx. 70%	Approx. 70%																																
168 type	54	Approx. 65%	Approx. 65%																																

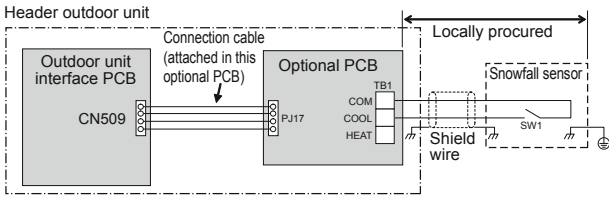
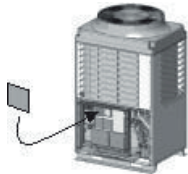
Model name	Appearance	Function																																													
TCB-PCMO4UL	 <p>Size: 2.19 × 2.35 (in)</p>	<p>[3] Operation mode selection control</p> <p>▼ Function The heating/cooling mode of the system can be selected by connecting to the interface PCB of outdoor units.</p> <p>▼ Operation The outdoor unit connection is for the header unit (U1).</p>																																													
	<p>Application</p>  <p>* Install the optional PCB in the inverter assembly of the outdoor header unit.</p>	 <p>SW1: Cooling mode specified input switch SW2: Heating mode specified input switch</p> <table border="1" data-bbox="699 788 1385 931"> <thead> <tr> <th colspan="2">Input Signal</th> <th rowspan="2">Operation: Selected operation mode</th> </tr> <tr> <th>Cooling (SW1)</th> <th>Heating (SW2)</th> </tr> </thead> <tbody> <tr> <td>ON</td> <td>OFF</td> <td>Cooling operation only</td> </tr> <tr> <td>OFF</td> <td>ON</td> <td>Heating operation only</td> </tr> <tr> <td>OFF</td> <td>OFF</td> <td>Normal operation</td> </tr> </tbody> </table> <p>Each terminal should be connected to dry contact.</p> <p>The Switching of processing of Indoor Unit Operation State Processing of the operation state can be switched for indoor units in a mode other than the selected operation mode by setting the jumper lead (J01) of the header outdoor unit interface PCB.</p> <table border="1" data-bbox="695 1158 1390 1778"> <thead> <tr> <th>Jumper lead</th> <th colspan="3">Details of Processing</th> </tr> </thead> <tbody> <tr> <td rowspan="4">J01 connected (factory default)</td> <td colspan="3">Unallowed indoor units in a mode other than the selected operation mode are not treated as priority (thermo OFF state). (Unallowed indoor units)</td> </tr> <tr> <td>Operation Mode</td> <td>Operation State</td> <td>Remote control</td> </tr> <tr> <td>Cooling unit</td> <td>Air blow operation at blow rate set on remote control</td> <td rowspan="3">⏻, ⏻ indicator is displayed.</td> </tr> <tr> <td>Heating unit</td> <td>Air blow operation at super-slow blow rate</td> </tr> <tr> <td>Air blow unit</td> <td>Regular air blow operation at blow rate set on remote control</td> </tr> <tr> <td rowspan="4">J01 cut</td> <td colspan="3">Indoor units in a mode other than the selected operation mode are forcibly switched to the selected operation mode.</td> </tr> <tr> <td>PC board selection mode</td> <td colspan="2">Remote control operation/display</td> </tr> <tr> <td>Normal</td> <td>❄️, ⏻, ❄️, or ❄️ can be selected</td> <td rowspan="3">When using the remote control, ⏻ (mode select control) indicator is displayed.</td> </tr> <tr> <td>Cool</td> <td>Only ❄️, ⏻, or ❄️ can be selected</td> </tr> <tr> <td>Heat</td> <td>Only ❄️ or ❄️ can be selected</td> </tr> </tbody> </table>	Input Signal		Operation: Selected operation mode	Cooling (SW1)	Heating (SW2)	ON	OFF	Cooling operation only	OFF	ON	Heating operation only	OFF	OFF	Normal operation	Jumper lead	Details of Processing			J01 connected (factory default)	Unallowed indoor units in a mode other than the selected operation mode are not treated as priority (thermo OFF state). (Unallowed indoor units)			Operation Mode	Operation State	Remote control	Cooling unit	Air blow operation at blow rate set on remote control	⏻, ⏻ indicator is displayed.	Heating unit	Air blow operation at super-slow blow rate	Air blow unit	Regular air blow operation at blow rate set on remote control	J01 cut	Indoor units in a mode other than the selected operation mode are forcibly switched to the selected operation mode.			PC board selection mode	Remote control operation/display		Normal	❄️, ⏻, ❄️, or ❄️ can be selected	When using the remote control, ⏻ (mode select control) indicator is displayed.	Cool	Only ❄️, ⏻, or ❄️ can be selected	Heat
Input Signal		Operation: Selected operation mode																																													
Cooling (SW1)	Heating (SW2)																																														
ON	OFF	Cooling operation only																																													
OFF	ON	Heating operation only																																													
OFF	OFF	Normal operation																																													
Jumper lead	Details of Processing																																														
J01 connected (factory default)	Unallowed indoor units in a mode other than the selected operation mode are not treated as priority (thermo OFF state). (Unallowed indoor units)																																														
	Operation Mode	Operation State	Remote control																																												
	Cooling unit	Air blow operation at blow rate set on remote control	⏻, ⏻ indicator is displayed.																																												
	Heating unit	Air blow operation at super-slow blow rate																																													
Air blow unit	Regular air blow operation at blow rate set on remote control																																														
J01 cut	Indoor units in a mode other than the selected operation mode are forcibly switched to the selected operation mode.																																														
	PC board selection mode	Remote control operation/display																																													
	Normal	❄️, ⏻, ❄️, or ❄️ can be selected	When using the remote control, ⏻ (mode select control) indicator is displayed.																																												
	Cool	Only ❄️, ⏻, or ❄️ can be selected																																													
Heat	Only ❄️ or ❄️ can be selected																																														

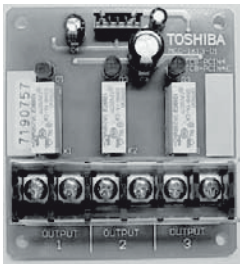
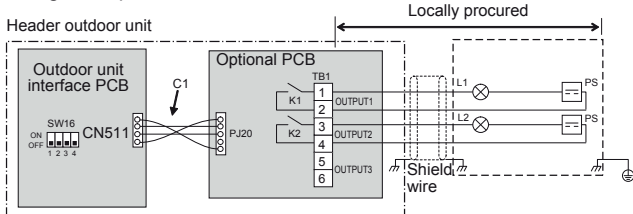
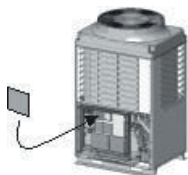
Model name	Appearance	Function														
TCB-PCMO4UL	 <p>Size: 2.19 × 2.35 (in)</p>	<p>[4] Snowfall fan control</p> <p>▼ Function The outdoor unit fan operates at snowfall by connecting to the outdoor unit interface PCB.</p> <p>▼ Operation</p>  <p>SW1: Snowfall detection switch (snowfall sensor)</p> <table border="1" style="width: 100%; border-collapse: collapse;"> <thead> <tr> <th>Terminal</th> <th>Input Signal</th> <th>Operation</th> </tr> </thead> <tbody> <tr> <td rowspan="4" style="text-align: center;">Cooling (SW1)</td> <td>ON</td> <td style="text-align: center;">▲</td> <td rowspan="2">Snowfall fan control (Fan in outdoor unit operates.)</td> </tr> <tr> <td>OFF</td> <td style="text-align: center;">▲</td> </tr> <tr> <td>ON</td> <td style="text-align: center;">▼</td> <td rowspan="2">Normal operation</td> </tr> <tr> <td>OFF</td> <td style="text-align: center;">▼</td> </tr> </tbody> </table> <p style="text-align: center;">Provide no-voltage continuous contacts for each terminal.</p>	Terminal	Input Signal	Operation	Cooling (SW1)	ON	▲	Snowfall fan control (Fan in outdoor unit operates.)	OFF	▲	ON	▼	Normal operation	OFF	▼
	Terminal		Input Signal	Operation												
	Cooling (SW1)		ON	▲	Snowfall fan control (Fan in outdoor unit operates.)											
OFF		▲														
ON		▼	Normal operation													
OFF		▼														
Application	 <p>* Install the optional PCB in the inverter assembly of the outdoor header unit.</p>															

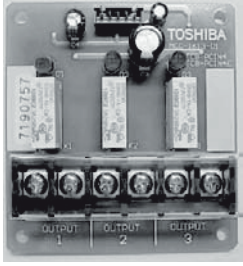
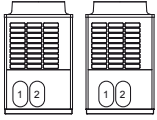
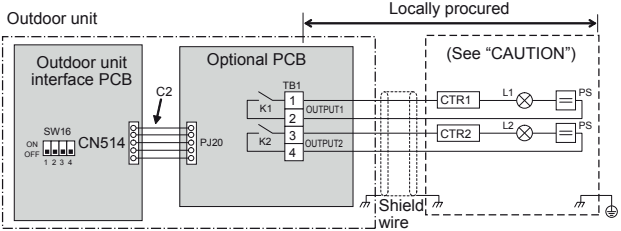
Model name	Appearance	Function																				
TCB-PCIN4UL	 <p>Size: 2.87 × 3.11 (in)</p>	<p>[1] Error / Operation Output</p> <p>▼ Function The operation error output PCB can indicate operation and error states by connecting to the interface PCB of outdoor units.</p> <p>▼ Operation Operation output: The operation indicator is on while any indoor unit in the system is operating. Error output: The error indicator is on when an error is occurred on even one of the indoor or outdoor units in the system.</p> <p>Wiring example</p>  <table border="1" style="width: 100%; border-collapse: collapse;"> <tbody> <tr> <td>C1</td> <td>Attached connection cable 1 (4wires)</td> </tr> <tr> <td>CN511</td> <td>Connector on interface side (green)</td> </tr> <tr> <td>K1, K2</td> <td>Relays</td> </tr> <tr> <td>L1</td> <td>Error indication Lamp</td> </tr> <tr> <td>L2</td> <td>Operation indication Lamp</td> </tr> <tr> <td>OUTPUT1</td> <td>Error output</td> </tr> <tr> <td>OUTPUT2</td> <td>Operation output</td> </tr> <tr> <td>PJ20</td> <td>Connector on optional PCB side</td> </tr> <tr> <td>PS</td> <td>Power supply unit</td> </tr> <tr> <td>TB1</td> <td>Terminal block</td> </tr> </tbody> </table> <p>* [OUTPUT3] is displayed when power is turned on.</p>	C1	Attached connection cable 1 (4wires)	CN511	Connector on interface side (green)	K1, K2	Relays	L1	Error indication Lamp	L2	Operation indication Lamp	OUTPUT1	Error output	OUTPUT2	Operation output	PJ20	Connector on optional PCB side	PS	Power supply unit	TB1	Terminal block
	C1		Attached connection cable 1 (4wires)																			
	CN511		Connector on interface side (green)																			
K1, K2	Relays																					
L1	Error indication Lamp																					
L2	Operation indication Lamp																					
OUTPUT1	Error output																					
OUTPUT2	Operation output																					
PJ20	Connector on optional PCB side																					
PS	Power supply unit																					
TB1	Terminal block																					
Application	 <p>* Install the optional PCB in the inverter assembly of the outdoor header unit.</p>																					

Model name	Appearance	Function																						
TCB-PCIN4UL	 <p>Size: 2.87 × 3.11 (in)</p>	<p>[2] Compressor Operation Output</p> <p>▼ Function While each compressor in the outdoor unit is running, the compressor operation signal is displayed. This function can also be used to measure the elapsed time for the compressor operation.</p> <p>▼ Operation During a compressor is in operation, the relay of the output terminal corresponding to that compressor turns on (closed) and turns OFF (opens) . When operation stops.</p> <p>As shown in the figure, the output terminals “OUTPUT1”, “OUTPUT2” from the left compressors facing to the front of the outdoor unit.</p>  <p>Wiring example</p>  <table border="1" data-bbox="719 1025 1402 1346"> <tr> <td>C2</td> <td>Connection cable 2 ([2])</td> </tr> <tr> <td>CN514</td> <td>Connector on interface side (green)</td> </tr> <tr> <td>CTR1</td> <td>Elapsed operation counter 1</td> </tr> <tr> <td>CTR2</td> <td>Elapsed operation counter 2</td> </tr> <tr> <td>K1, K2</td> <td>Relays</td> </tr> <tr> <td>L1, L2, L3</td> <td>Operation indication LEDs</td> </tr> <tr> <td>OUTPUT1</td> <td>Compressor 1 operation output terminal</td> </tr> <tr> <td>OUTPUT2</td> <td>Compressor 2 operation output terminal</td> </tr> <tr> <td>PJ20</td> <td>Connector on optional PCB side</td> </tr> <tr> <td>PS</td> <td>Power supply unit</td> </tr> <tr> <td>TB1</td> <td>Terminal block</td> </tr> </table>	C2	Connection cable 2 ([2])	CN514	Connector on interface side (green)	CTR1	Elapsed operation counter 1	CTR2	Elapsed operation counter 2	K1, K2	Relays	L1, L2, L3	Operation indication LEDs	OUTPUT1	Compressor 1 operation output terminal	OUTPUT2	Compressor 2 operation output terminal	PJ20	Connector on optional PCB side	PS	Power supply unit	TB1	Terminal block
	C2		Connection cable 2 ([2])																					
	CN514		Connector on interface side (green)																					
CTR1	Elapsed operation counter 1																							
CTR2	Elapsed operation counter 2																							
K1, K2	Relays																							
L1, L2, L3	Operation indication LEDs																							
OUTPUT1	Compressor 1 operation output terminal																							
OUTPUT2	Compressor 2 operation output terminal																							
PJ20	Connector on optional PCB side																							
PS	Power supply unit																							
TB1	Terminal block																							
Application	 <p>* Install the optional PCB in the inverter assembly of individual outdoor unit.</p>																							

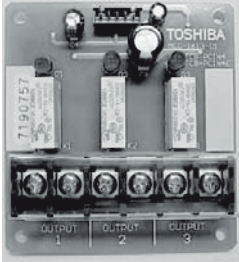
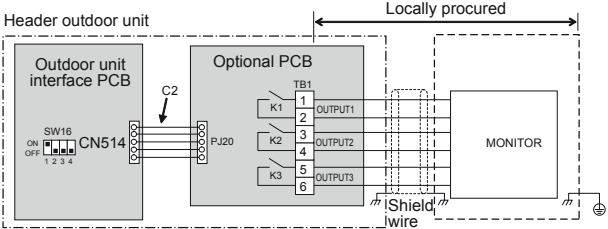
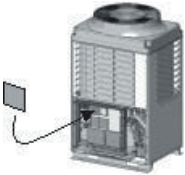
Model name	Appearance	Function																																																																	
TCB-PCIN4UL	 <p style="text-align: center;">Size: 2.87 × 3.11 (in)</p> <p style="text-align: center;">Application</p>	<p>[3] Operating Rate Output</p> <p>▼ Function The state of operation is available to check remotely as the signal of system operation rate enable to output.</p> <p>▼ Operation As shown in the table, each of the output terminals turns ON (relay closes) and OFF (relay opens) depending on the system operating rate.</p> <table border="1" data-bbox="730 562 1417 808"> <thead> <tr> <th>Functions</th> <th>SW16</th> <th>OUTPUT1</th> <th>OUTPUT2</th> <th>OUTPUT3</th> <th>Operating rate FA</th> </tr> </thead> <tbody> <tr> <td rowspan="8" style="vertical-align: middle;">System operating rate output</td> <td>OFF</td> <td>OFF</td> <td>OFF</td> <td>OFF</td> <td>FA = 0%</td> </tr> <tr> <td>ON</td> <td>OFF</td> <td>OFF</td> <td>OFF</td> <td>0% < FA < 20%</td> </tr> <tr> <td>OFF</td> <td>ON</td> <td>OFF</td> <td>OFF</td> <td>20% ≤ FA < 35%</td> </tr> <tr> <td>ON</td> <td>ON</td> <td>OFF</td> <td>OFF</td> <td>35% ≤ FA < 50%</td> </tr> <tr> <td>OFF</td> <td>OFF</td> <td>ON</td> <td>OFF</td> <td>50% ≤ FA < 65%</td> </tr> <tr> <td>ON</td> <td>OFF</td> <td>ON</td> <td>OFF</td> <td>65% ≤ FA < 80%</td> </tr> <tr> <td>OFF</td> <td>ON</td> <td>ON</td> <td>OFF</td> <td>80% ≤ FA < 95%</td> </tr> <tr> <td>ON</td> <td>ON</td> <td>ON</td> <td>ON</td> <td>95% ≤ FA</td> </tr> </tbody> </table> <p style="text-align: right;">OFF=relay open ON=relay closed</p> <p>Wiring example</p>  <table border="1" data-bbox="730 1140 1417 1391"> <tbody> <tr> <td>C2</td> <td>Attached connection cable 2 (5wires)</td> </tr> <tr> <td>CN514</td> <td>Connector on interface side (green)</td> </tr> <tr> <td>K1, K2, K3</td> <td>Relays</td> </tr> <tr> <td>MONITOR</td> <td>Monitoring device</td> </tr> <tr> <td>OUTPUT1</td> <td>Output terminal for each function</td> </tr> <tr> <td>OUTPUT2</td> <td>Output terminal for each function</td> </tr> <tr> <td>OUTPUT3</td> <td>Output terminal for each function</td> </tr> <tr> <td>PJ20</td> <td>Connector on optional PCB side</td> </tr> <tr> <td>TB1</td> <td>Terminal block</td> </tr> </tbody> </table>	Functions	SW16	OUTPUT1	OUTPUT2	OUTPUT3	Operating rate FA	System operating rate output	OFF	OFF	OFF	OFF	FA = 0%	ON	OFF	OFF	OFF	0% < FA < 20%	OFF	ON	OFF	OFF	20% ≤ FA < 35%	ON	ON	OFF	OFF	35% ≤ FA < 50%	OFF	OFF	ON	OFF	50% ≤ FA < 65%	ON	OFF	ON	OFF	65% ≤ FA < 80%	OFF	ON	ON	OFF	80% ≤ FA < 95%	ON	ON	ON	ON	95% ≤ FA	C2	Attached connection cable 2 (5wires)	CN514	Connector on interface side (green)	K1, K2, K3	Relays	MONITOR	Monitoring device	OUTPUT1	Output terminal for each function	OUTPUT2	Output terminal for each function	OUTPUT3	Output terminal for each function	PJ20	Connector on optional PCB side	TB1	Terminal block
	Functions		SW16	OUTPUT1	OUTPUT2	OUTPUT3	Operating rate FA																																																												
System operating rate output	OFF	OFF	OFF	OFF	FA = 0%																																																														
	ON	OFF	OFF	OFF	0% < FA < 20%																																																														
	OFF	ON	OFF	OFF	20% ≤ FA < 35%																																																														
	ON	ON	OFF	OFF	35% ≤ FA < 50%																																																														
	OFF	OFF	ON	OFF	50% ≤ FA < 65%																																																														
	ON	OFF	ON	OFF	65% ≤ FA < 80%																																																														
	OFF	ON	ON	OFF	80% ≤ FA < 95%																																																														
	ON	ON	ON	ON	95% ≤ FA																																																														
C2	Attached connection cable 2 (5wires)																																																																		
CN514	Connector on interface side (green)																																																																		
K1, K2, K3	Relays																																																																		
MONITOR	Monitoring device																																																																		
OUTPUT1	Output terminal for each function																																																																		
OUTPUT2	Output terminal for each function																																																																		
OUTPUT3	Output terminal for each function																																																																		
PJ20	Connector on optional PCB side																																																																		
TB1	Terminal block																																																																		
 <p>* Install the optional PCB in the inverter assembly of the outdoor header unit.</p>																																																																			

Dimensions of P.C. board

Unit: in (mm)

TCB-PCDM4UL

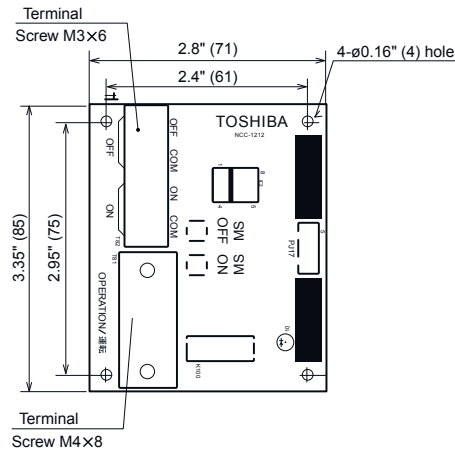

TCB-PCMO4UL

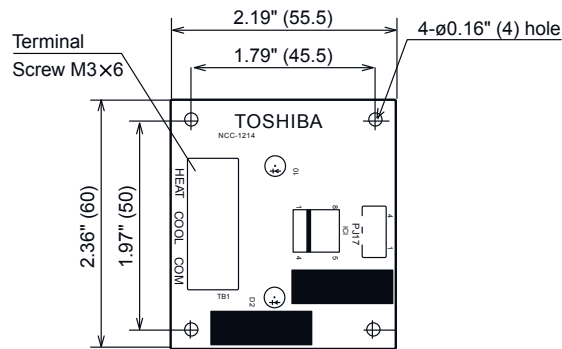

TCB-PCIN4UL

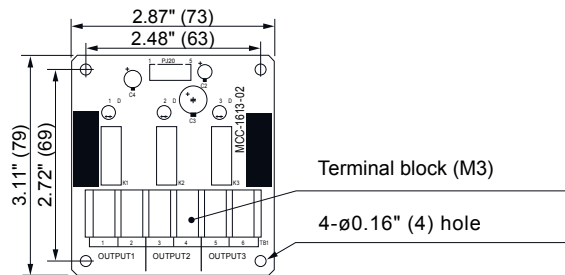

5-10. Sound pressure level data

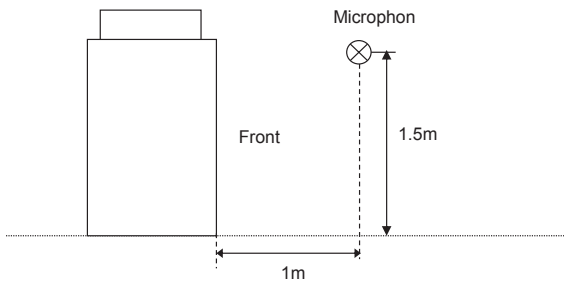

Standard model

MMY-MAP0726FT9/6P-UL

Sound pressure Level (dB(A))	Cooling	Heating
	57.0	60.0

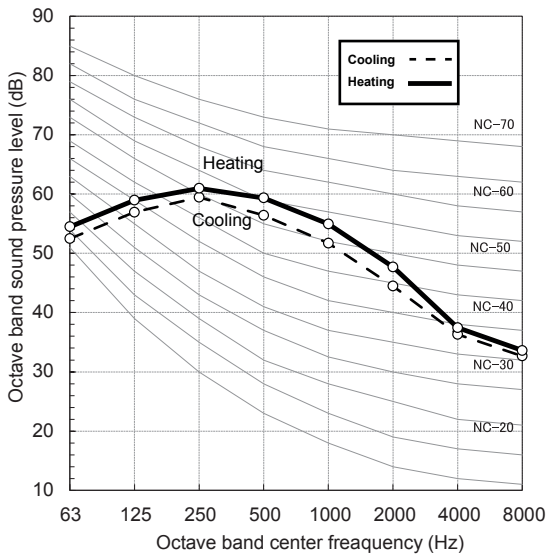

MMY-MAP0966FT9/6P-UL

Sound pressure Level (dB(A))	Cooling	Heating
	62.0	62.0

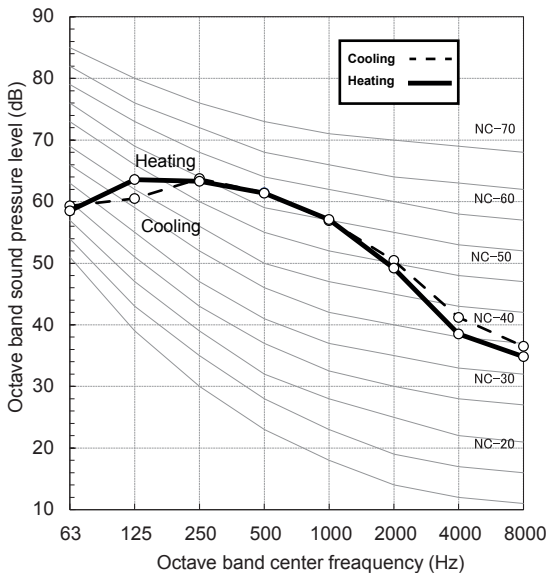

MMY-MAP1206FT9/6P-UL

Sound pressure Level (dB(A))	Cooling	Heating
	63.0	64.0

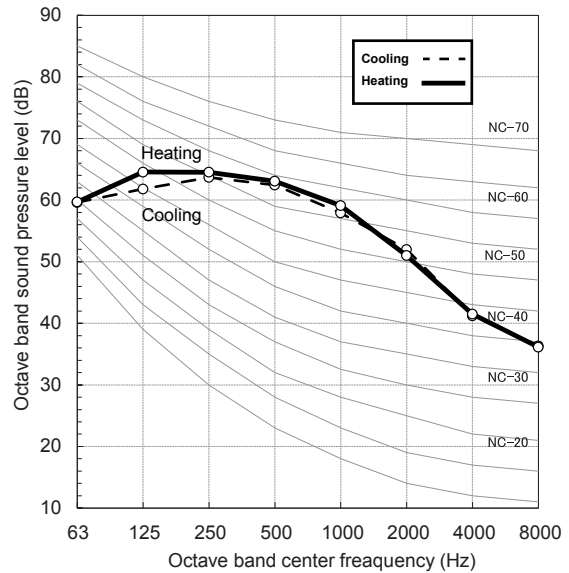

MMY-MAP1446FT9/6P-UL

Sound pressure Level (dB(A))	Cooling	Heating
	66.5	66.5

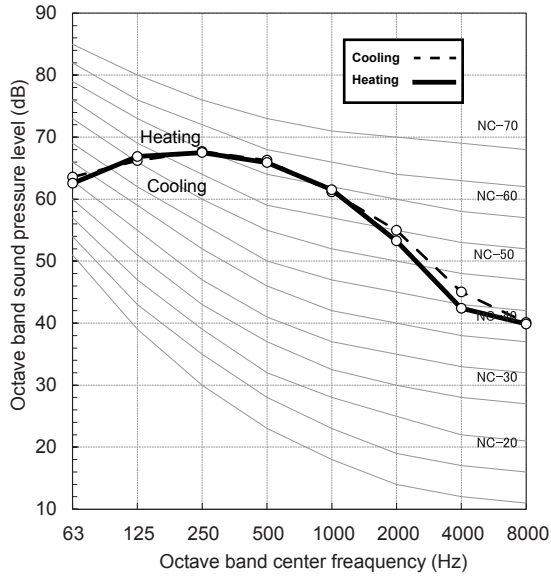

MMY-MAP1686FT9/6P-UL

Sound pressure Level (dB(A))	Cooling	Heating
	66.5	67.0

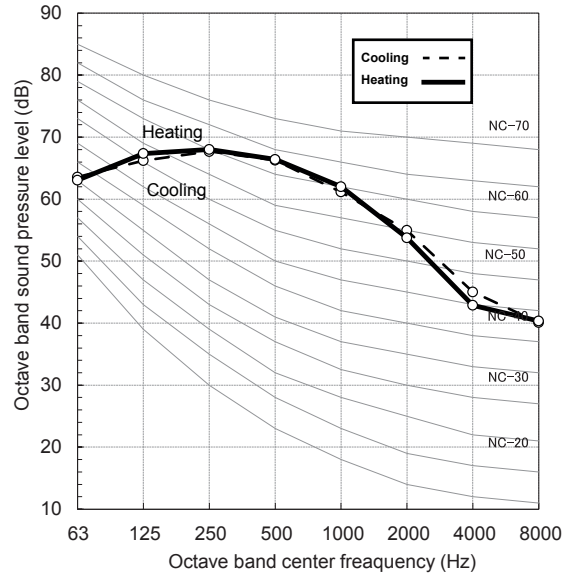

MMY-MAP1926FT9/6P-UL

Sound pressure Level (dB(A))	Cooling	Heating
	65.0	65.0

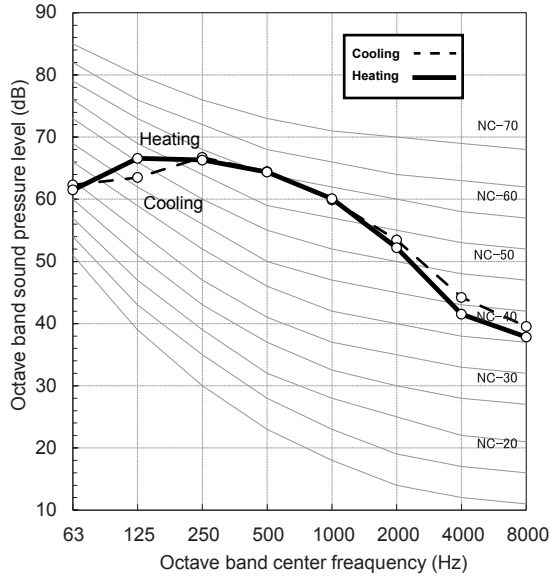

MMY-MAP2166FT9/6P-UL

Sound pressure Level (dB(A))	Cooling	Heating
	65.5	66.5

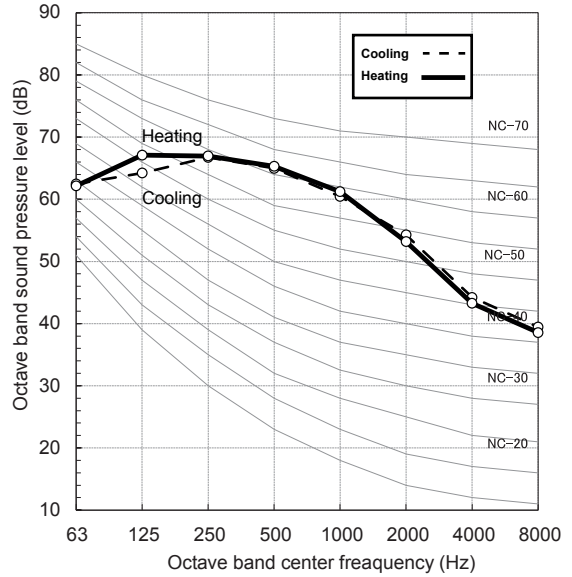

MMY-MAP2406FT9/6P-UL

Sound pressure Level (dB(A))	Cooling	Heating
	68.0	68.0

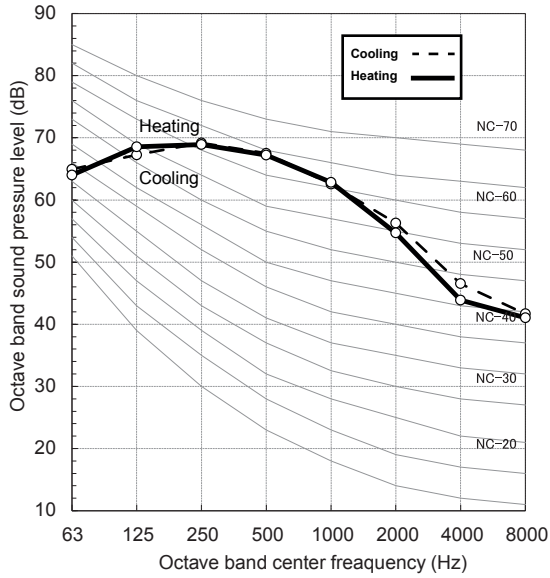

MMY-MAP2646FT9/6P-UL

Sound pressure Level (dB(A))	Cooling	Heating
	68.5	68.5

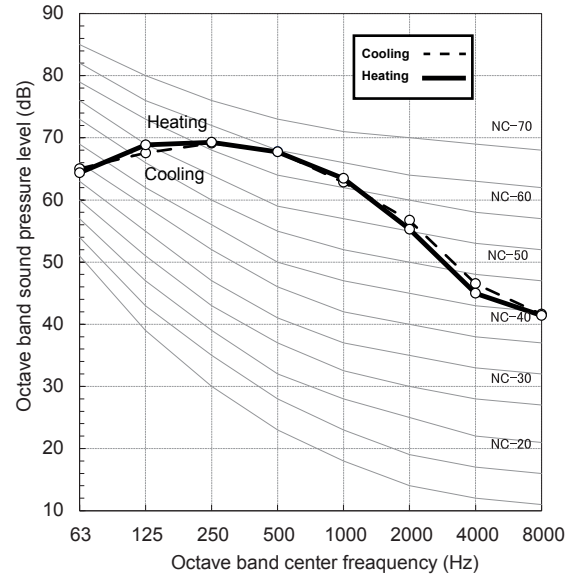

MMY-MAP2886FT9/6P-UL

Sound pressure Level (dB(A))	Cooling	Heating
	69.5	69.5

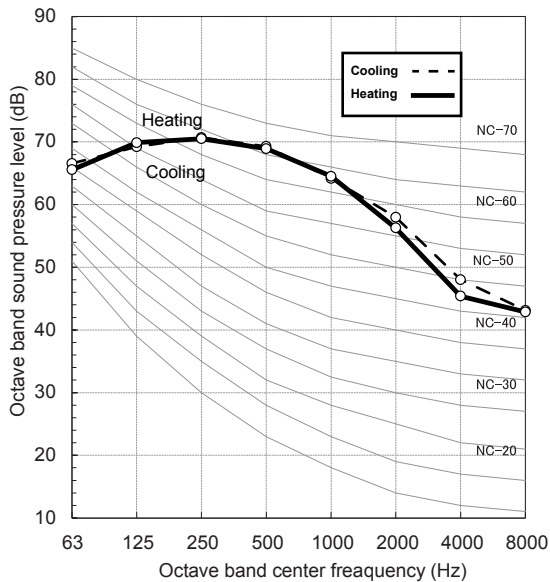

MMY-MAP3126FT9/6P-UL

Sound pressure Level (dB(A))	Cooling	Heating
	69.5	70.0

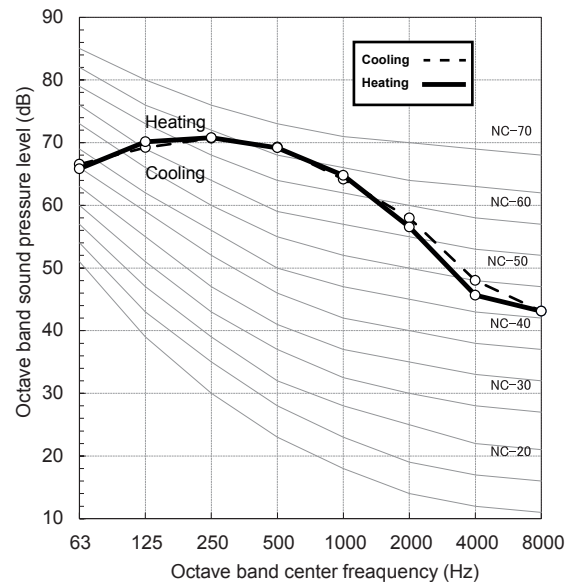

MMY-MAP3366FT9/6P-UL

Sound pressure Level (dB(A))	Cooling	Heating
	67.5	68.5

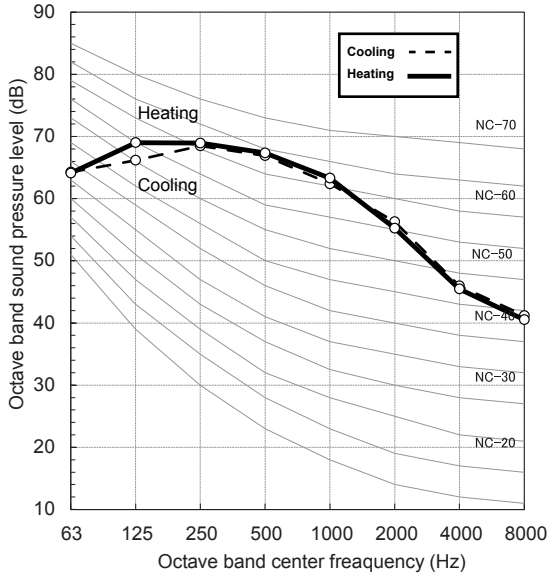

MMY-MAP3606FT9/6P-UL

Sound pressure Level (dB(A))	Cooling	Heating
	68.0	69.0

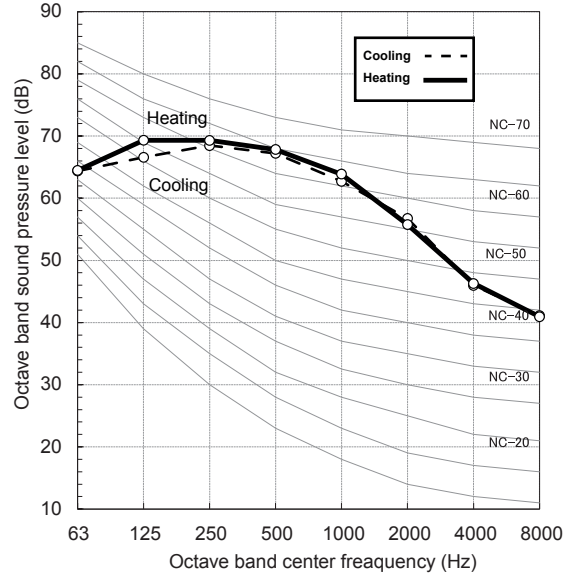

MMY-MAP3846FT9/6P-UL

Sound pressure Level (dB(A))	Cooling	Heating
	69.5	70.0

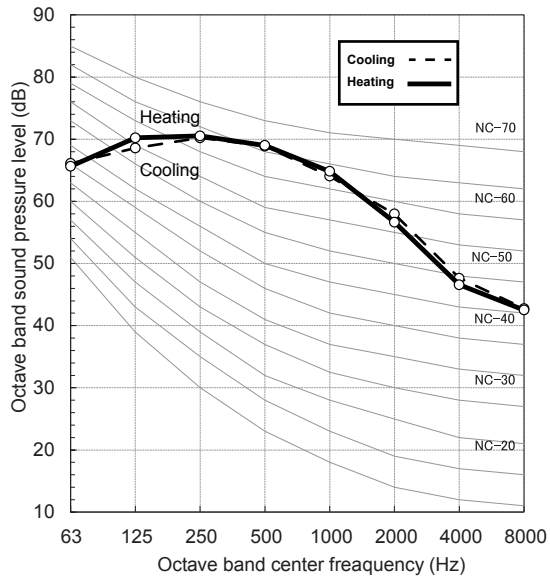

MMY-MAP4086FT9/6P-UL

Sound pressure Level (dB(A))	Cooling	Heating
	70.5	71.0

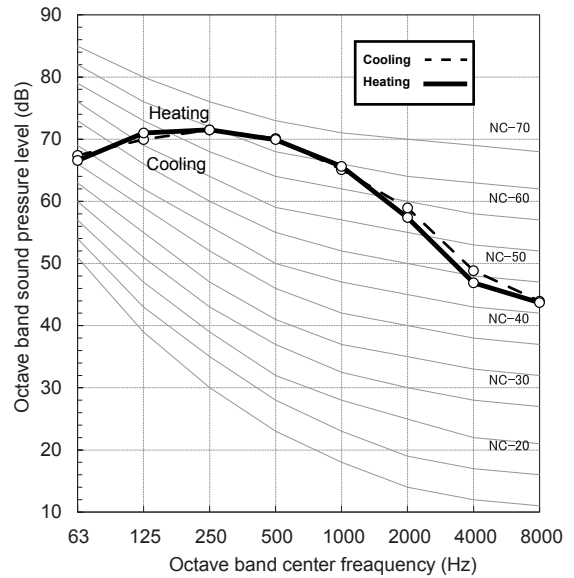



MMY-MAP4326FT9/6P-UL

Sound pressure Level (dB(A))	Cooling	Heating
	71.5	71.5

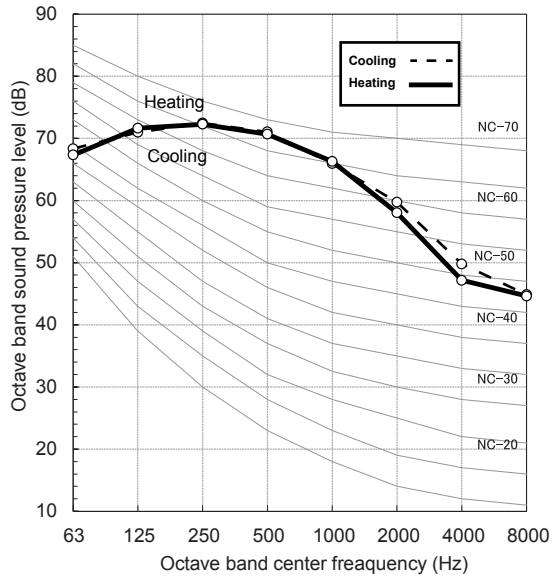

MMY-MAP4566FT9/6P-UL

Sound pressure Level (dB(A))	Cooling	Heating
	71.5	71.5

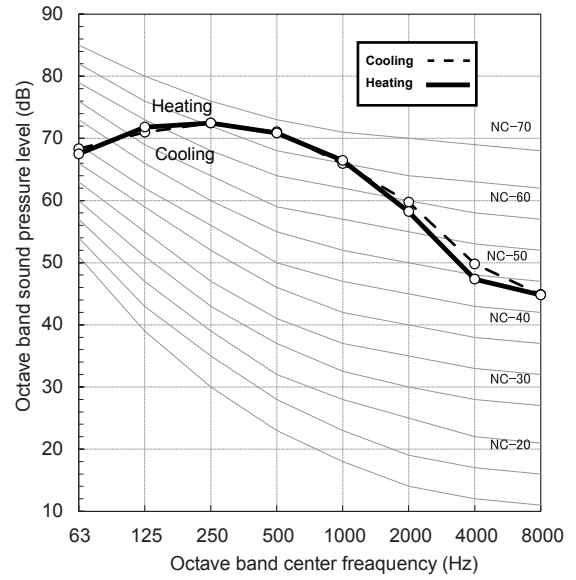

Space saving model

MMY-MAP192S6FT9/6P-UL

Sound pressure Level (dB(A))	Cooling	Heating
	64.0	65.5

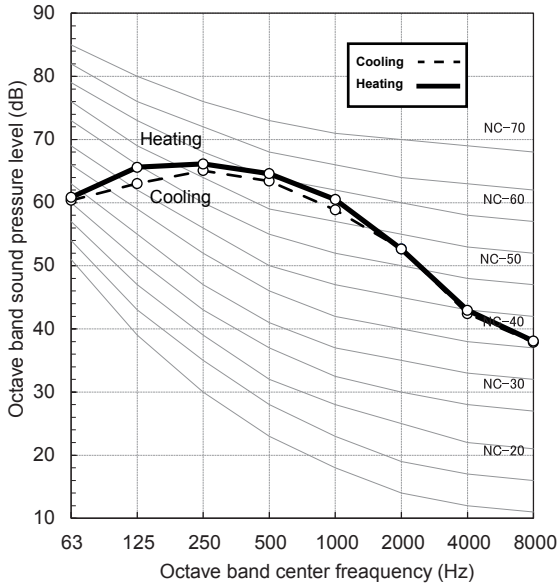

MMY-MAP240S6FT9/6P-UL

Sound pressure Level (dB(A))	Cooling	Heating
	66.0	67.0

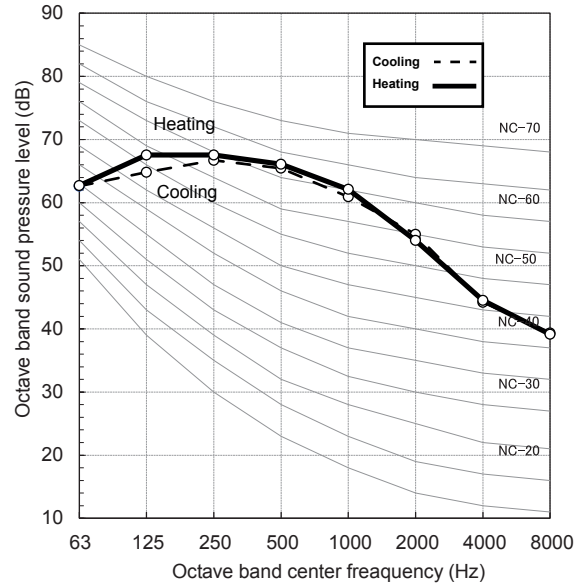

MMY-MAP288S6FT9/6P-UL

Sound pressure Level (dB(A))	Cooling	Heating
	68.5	69.0

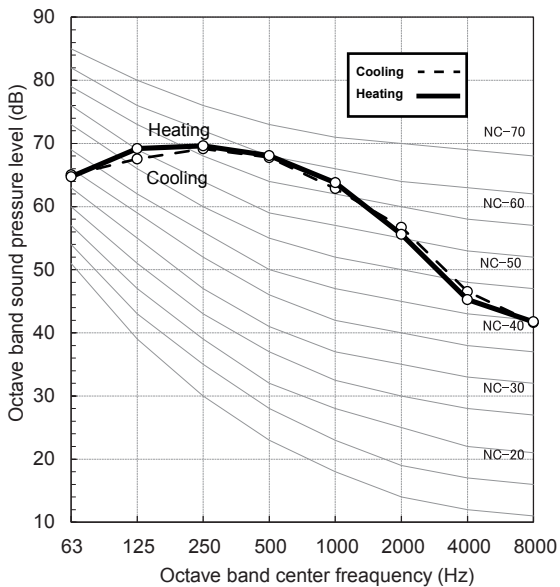

MMY-MAP336S6FT9/6P-UL

Sound pressure Level (dB(A))	Cooling	Heating
	69.5	70.0

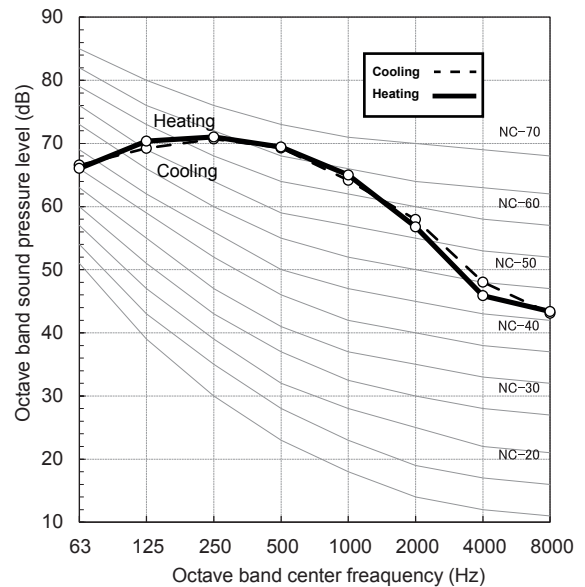



Standard model

MMY-MAP0726FT2P-UL

Sound pressure Level (dB(A))	Cooling	Heating
	57.0	60.0

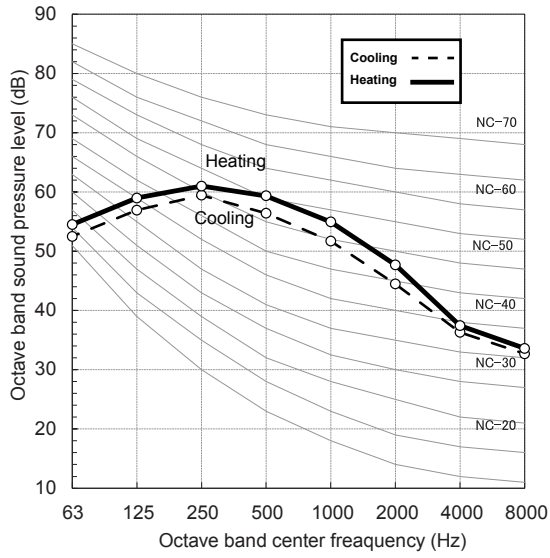

MMY-MAP1446FT2P-UL

Sound pressure Level (dB(A))	Cooling	Heating
	60.0	63.0

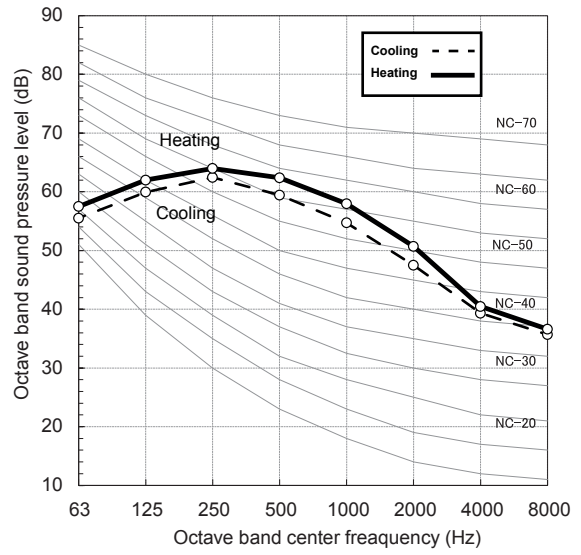

5-11. FS unit (Flow Selector unit)

Specifications (Single)

Model Name	RBM-Y0383FUL	RBM-Y0613FUL	RBM-Y0963FUL
Power supply	230 V (208/230 V) 1 phase 60 Hz		
Connectable indoor unit capacity (kBtu/h)	Below 38	38 to below 61	61 to 96 or less
Dimension	Height (in)	7.49	7.88
	Width (in)	9.77	9.77
	Depth (in)	6.3	6.3
Total Weight (lbs)	11	13	20
Connecting port dia. (Indoor unit side)	Liquid side (in)	3/8"	3/8"
	Gas side (in)	5/8"	5/8"
Connecting port dia. (Outdoor unit side)	Liquid side (in)	3/8"	3/8"
	Discharge gas side (in)	1/2"	1/2"
	Suction gas side (in)	5/8"	5/8"
Connection	Braze connection		

External view

RBM-Y0383FUL, RBM-Y0613FUL

(Unit: in (mm))

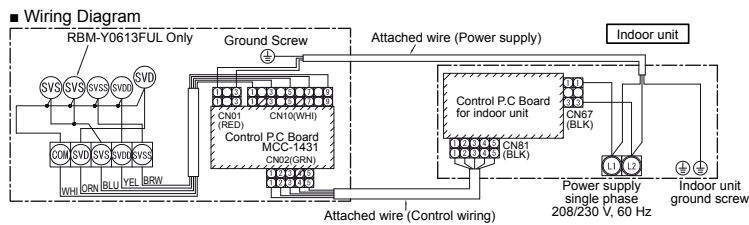
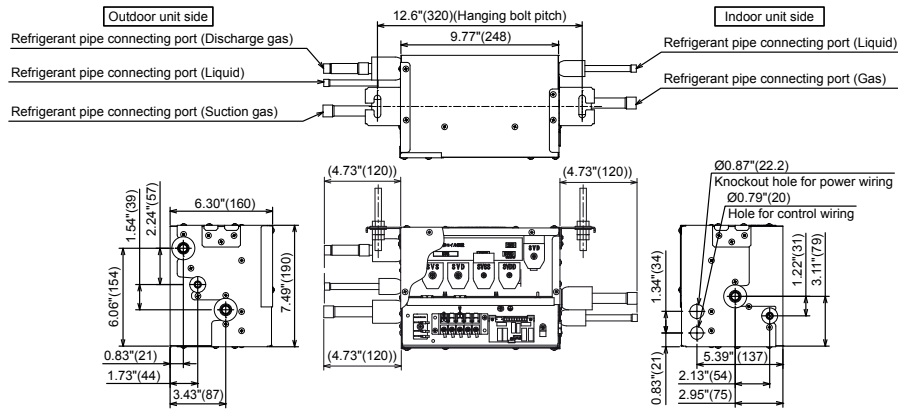

RBM-Y0963FUL

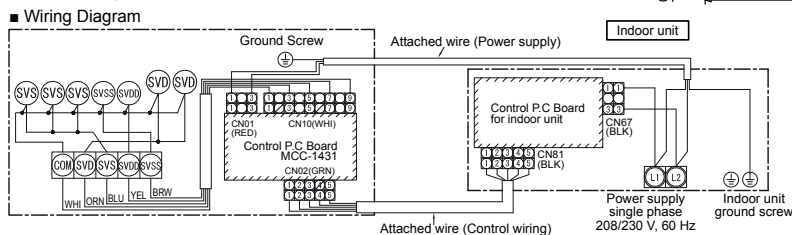
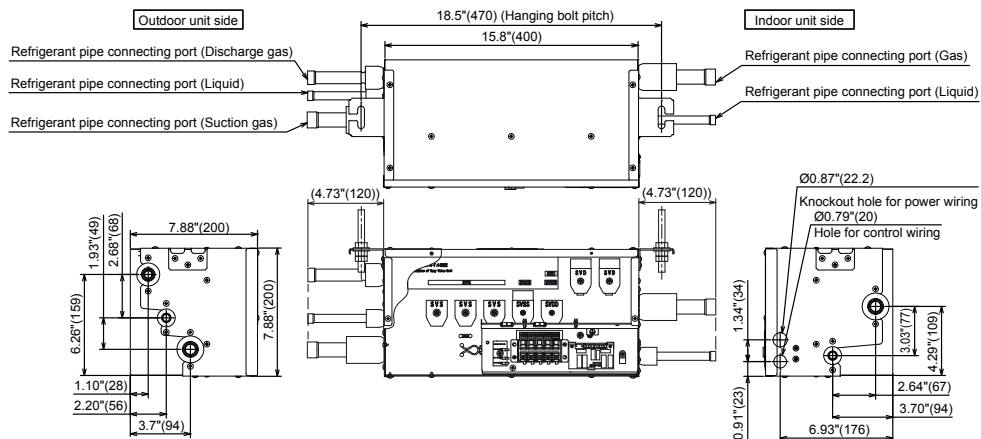

<Installation space>

Single

(Unit: in (mm))

<RBM-Y0383FUL / Y0613FUL>

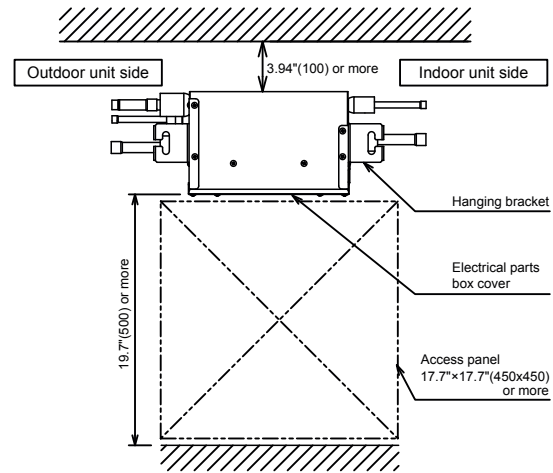
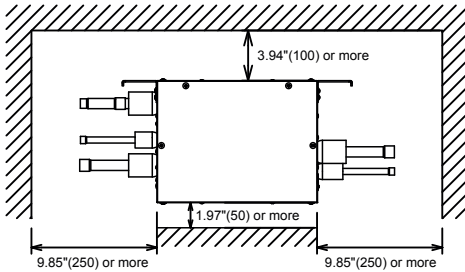

<RBM-Y0383FUL (When attached pipes are used)>

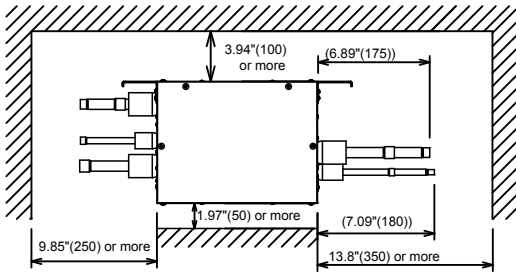

<RBM-Y0963FUL>

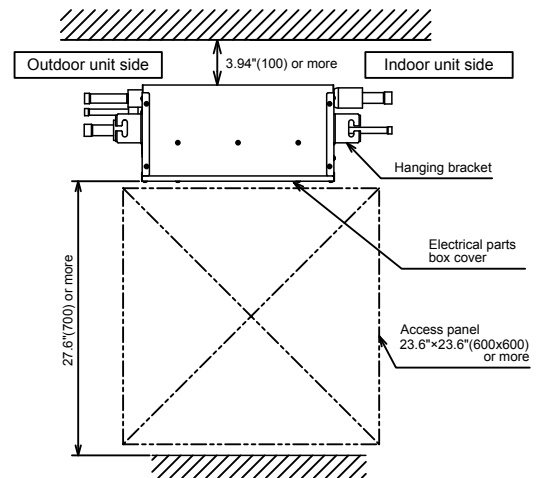
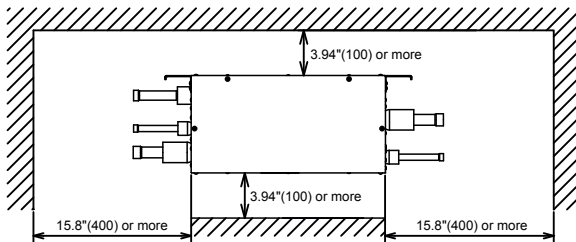

Refrigeration cycle diagram (Single)

Model RBM-Y0383FUL

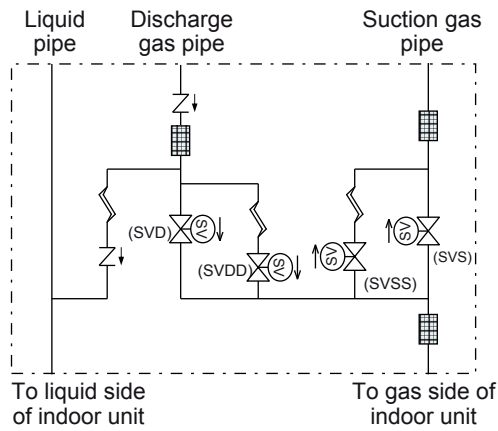

Model RBM-Y0613FUL

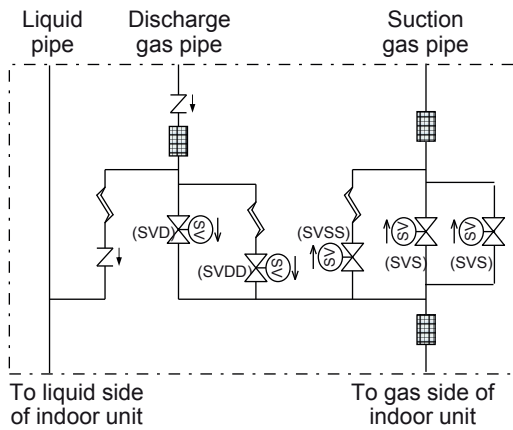

Model RBM-Y0963FUL

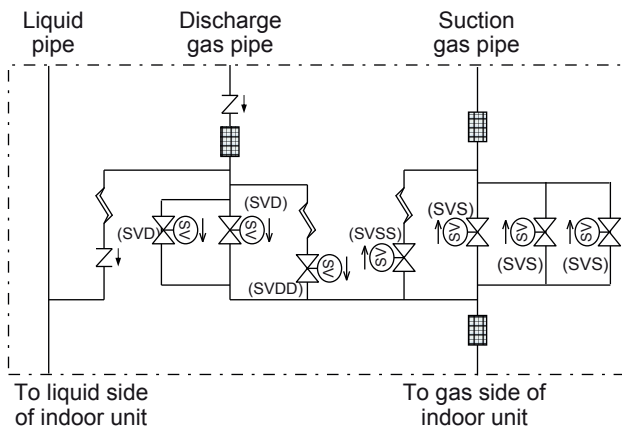

Symbol				
	Solenoid Valve	Capillary Tube	Check Valve	Strainer

Specifications (Single)

Model Name	RBM-Y0384FUL	RBM-Y0614FUL	RBM-Y0964FUL
Power supply	230V (208/230V) 1phase 60Hz		
Connectable indoor unit capacity per 1 branch (kBtu/h)	Below 38	38 to below 61	61 to 96 or less
Connectable indoor units	5	8	12
Dimension	Height (in)	7.1	7.1
	Width (in)	16.7	16.7
	Depth (in)	11.8	13.8
Weight (lbs)	29	29	40
Connecting port dia. (Indoor unit side)	Liquid side (in)	φ9.5	φ9.5
	Gas side (in)	φ15.9	φ15.9
Connecting port dia. (Outdoor unit side)	Liquid side (in)	φ9.5	φ9.5
	Discharge gas side (in)	φ12.7	φ12.7
	Suction gas side (in)	φ15.9	φ15.9
Connection	Brazing connection		

External view

RBM-Y0384FUL, RBM-Y0614FUL

(Unit: in (mm))

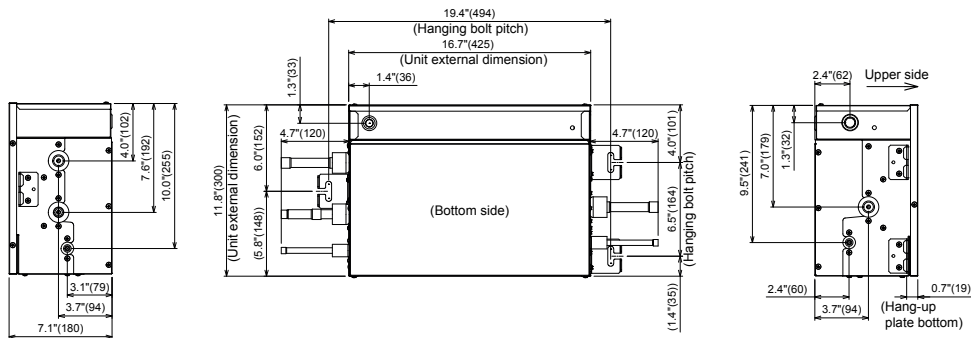

RBM-Y0964FUL

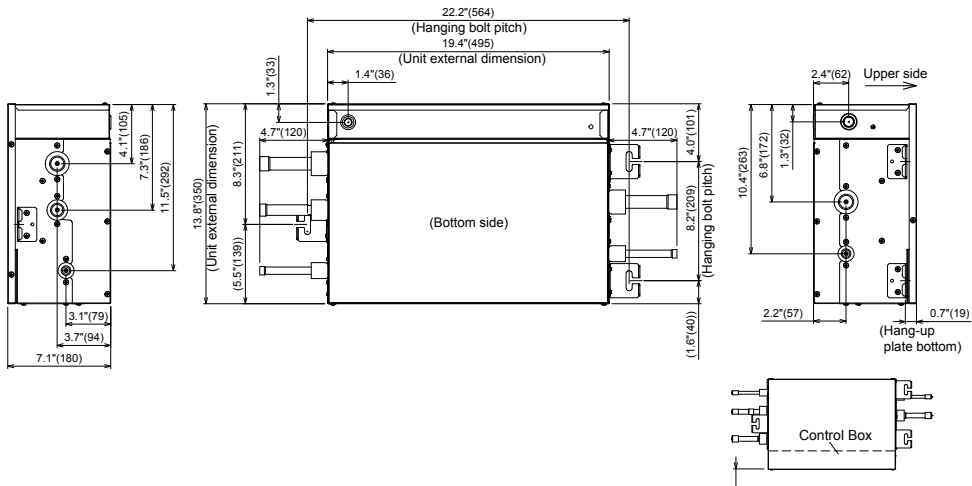

■ Specifications

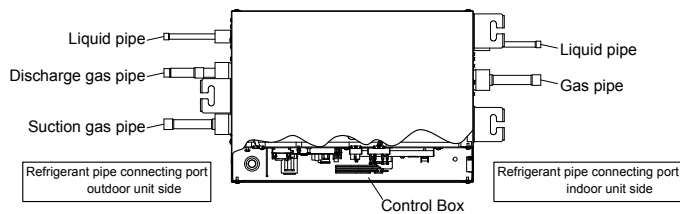

Wiring Diagram

RBM-Y0384FUL , RBM-Y0614FUL , RBM-Y0964FUL

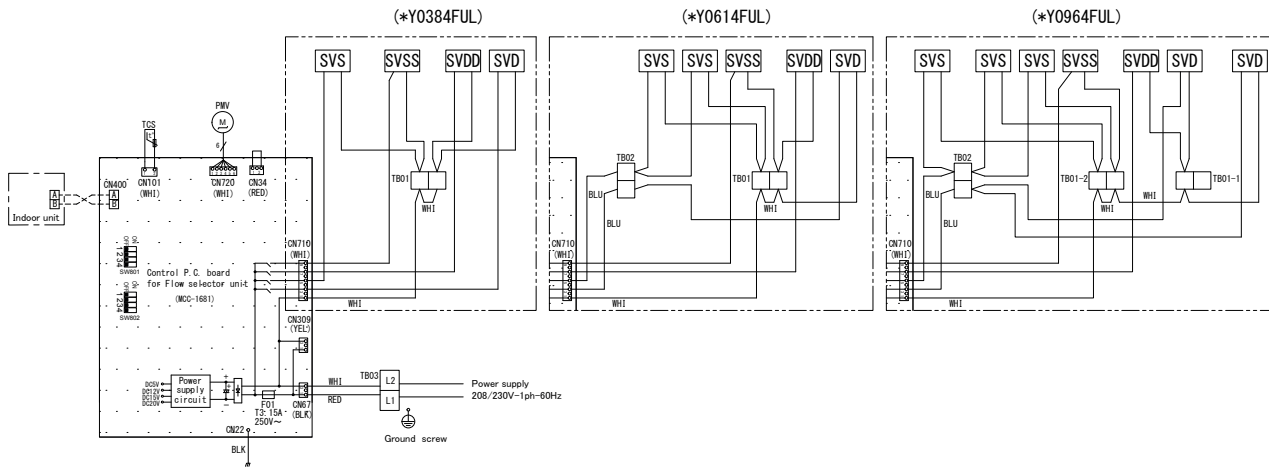

Color indication	Symbol	Parts Name
RED:RED	CN**	Connector
WHI:WHITE	F01	Fuse
YEL:YELLOW	TB01.02.03	Terminal Block
BLU:BLUE	TCS	Temp. sensor
BLK:BLACK	PMV	Pulse Motor Valve
BRN:BROWN	SVS,SVSS,SVDD,SVD	Coil-2way-Valve

- Broken line indicates the field wiring.
Long dashed short dashed line indicate the accessories.
Two dot line indicates the UNIT area.
- indicates the terminal block.
 indicates the connection terminal.
 indicates the connector on the control P.C.board.
- indicates the protection grounds.
- indicates the control P.C. board.

Refrigerant Diagram

RBM-Y0384FUL , RBM-Y0614FUL , RBM-Y0964FUL

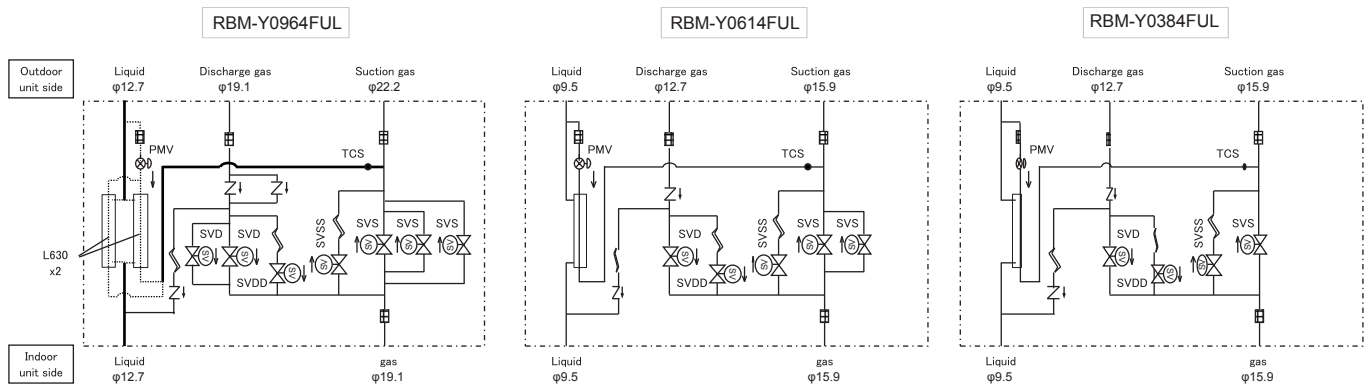

Specifications (Multi)

Model Name		RBM-Y0611F4PUL	RBM-Y0611F6PUL
Power supply		230 V (208/230 V) 1 phase 60 Hz	
Connectable indoor unit capacity (kBTu/h)		Below 61	Below 61
Dimension	Height (in)	8.5	8.5
	Width (in)	28.8	41.6
	Depth (in)	22.4	22.4
Total Weight (lbs)		84	117
Connecting port dia. (Indoor unit side)	Liquid side (in)	3/8"	3/8"
	Gas side (in)	5/8"	5/8"
Connecting port dia. (Outdoor unit side)	Liquid side (in)	7/8"	7/8"
	Discharge gas side (in)	1 1/8"	1 1/8"
	Suction gas side (in)	1 1/2"	1 1/2"
Connection		Brazing connection	

External view

RBM-Y0611F4PUL, RBM-Y0611F6PUL

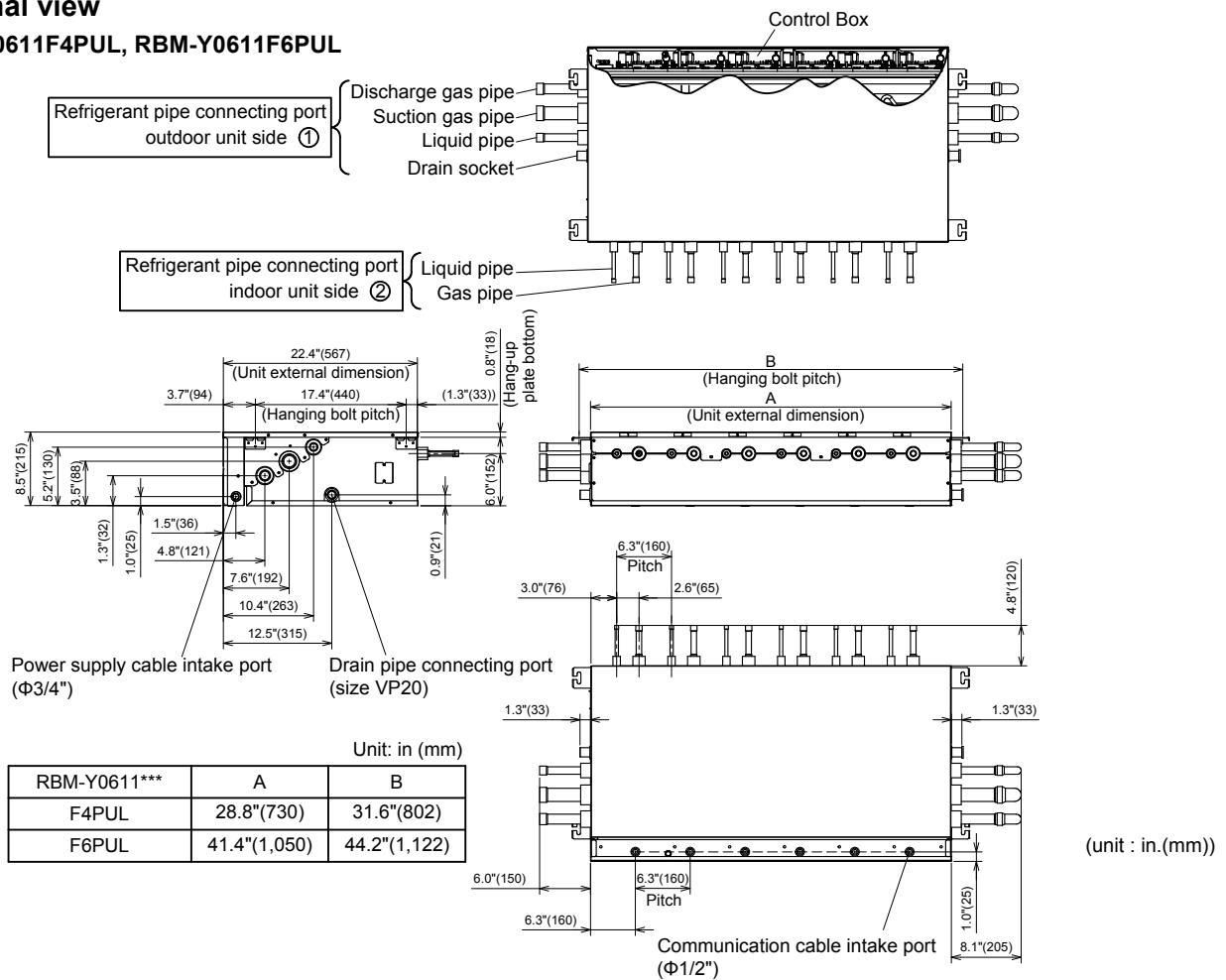

Wiring Diagram

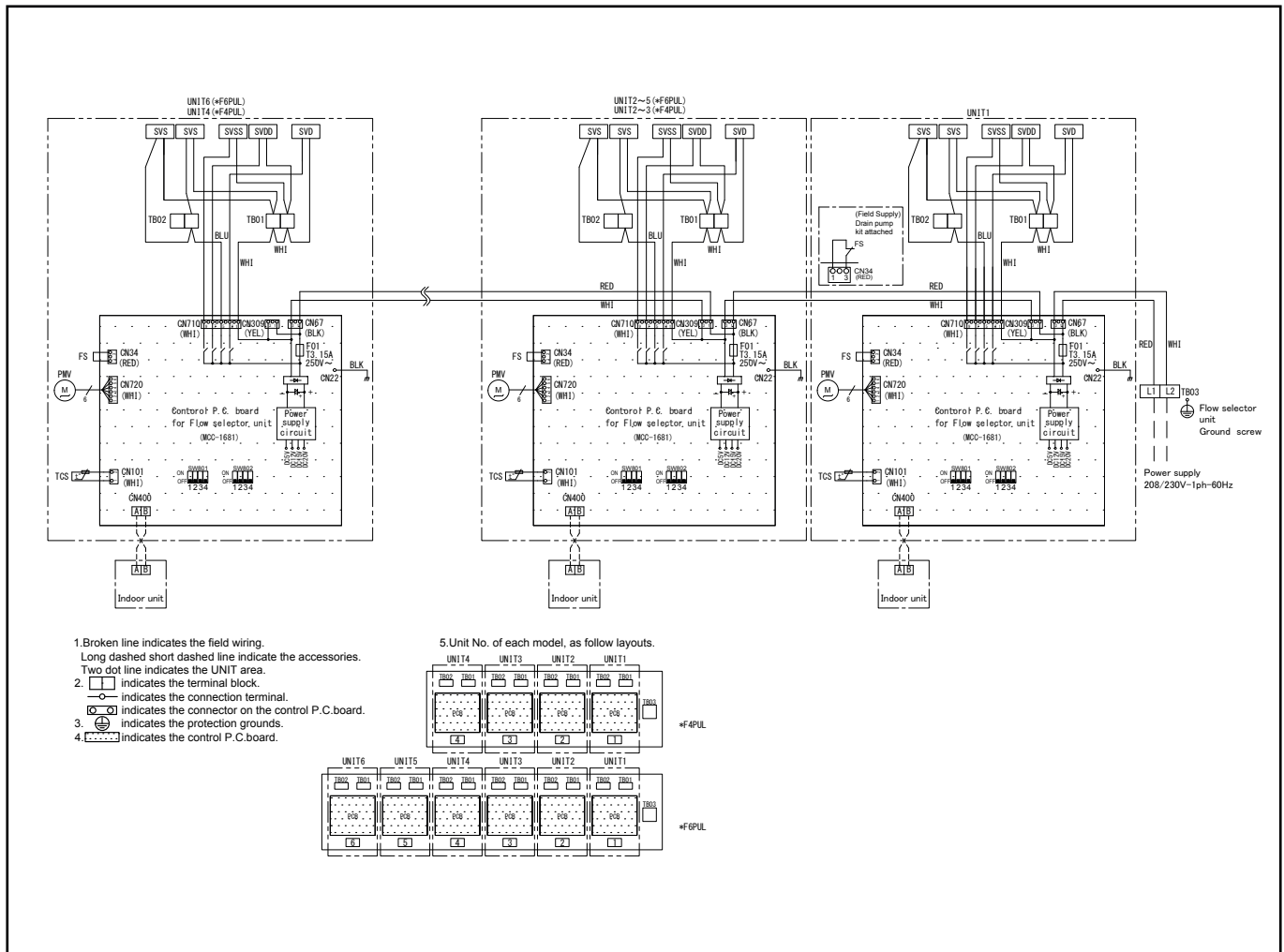

Center of gravity

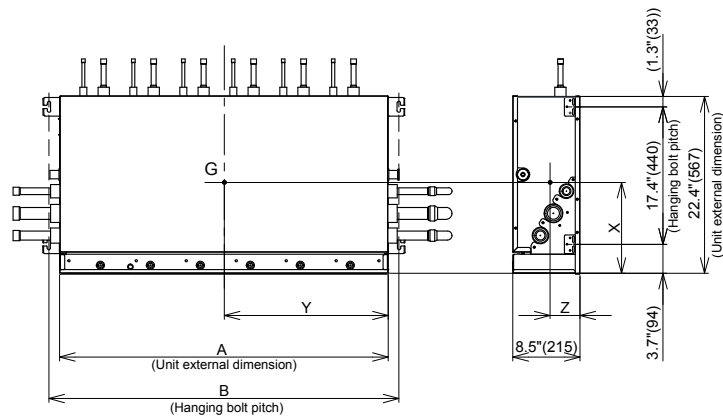

RBM-Y0611***	A	B	X	Y	Z	Weight [lbs (kg)]
F4PUL	28.8"(730)	31.6"(802)	11.6"(293)	14.4"(365)	3.8"(96)	84(38)
F6PUL	41.4"(1,050)	44.2"(1,122)	11.6"(293)	20.7"(525)	3.8"(96)	117(53)

<Installation space>

Multi

<RBM-Y0611F4PUL , RBM-Y0611F6PUL>

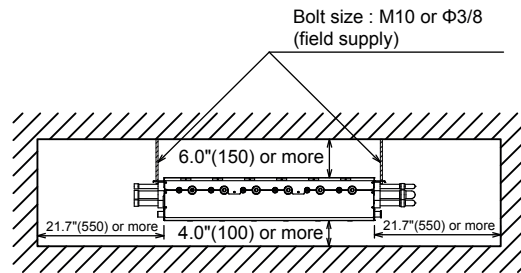
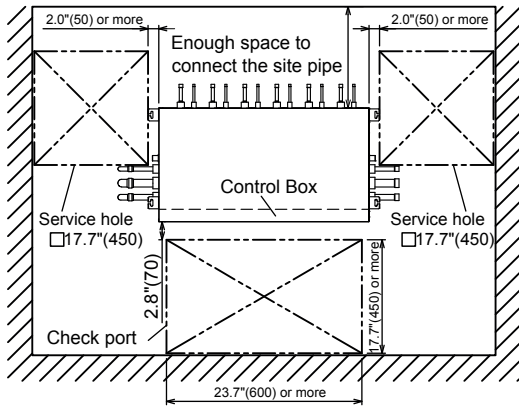

Refrigeration cycle diagram (Multi)

Model RBM-Y0611F4PUL , RBMY0611F6PUL

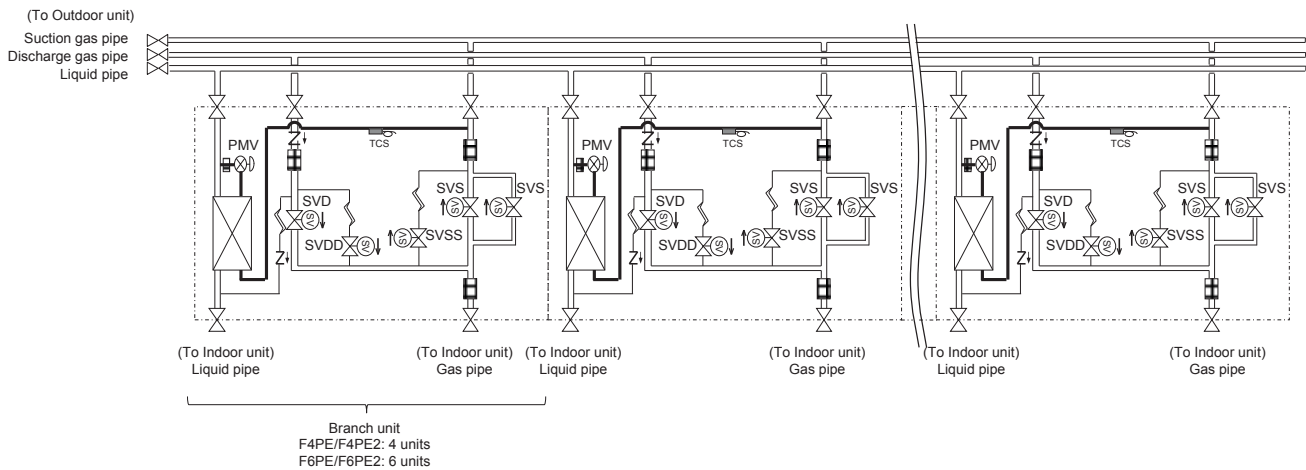

Symbol					
	Solenoid Valve	Capillary Tube	Check Valve	Strainer	Stop

APPENDIX

208/230 V, 3 phase Model

Efficiency Ratings

System with Non-ducted indoor units

Model name		
MMY-MAP0726FT6P-UL	EER	14.6
	IEER	26.6
	COP(47F)	3.67
MMY-MAP0966FT6P-UL	EER	12.5
	IEER	28.3
	COP(47F)	3.85
MMY-MAP1206FT6P-UL	EER	11.8
	IEER	27.5
	COP(47F)	3.61
MMY-MAP1446FT6P-UL	EER	12.2
	IEER	25.9
	COP(47F)	3.75
MMY-MAP1686FT6P-UL	EER	10.7
	IEER	23.3
	COP(47F)	3.44
MMY-AP1926FT6P-UL	EER	12.2
	IEER	26.1
	COP(47F)	3.70
MMY-AP2166FT6P-UL	EER	11.6
	IEER	24.2
	COP(47F)	3.57
MMY-AP2406FT6P-UL	EER	11.6
	IEER	23.3
	COP(47F)	3.60
MMY-AP2646FT6P-UL	EER	10.9
	IEER	23.1
	COP(47F)	3.40
MMY-AP2886FT6P-UL	EER	11.1
	IEER	22.8
	COP(47F)	3.45
MMY-AP3126FT6P-UL	EER	10.3
	IEER	22.1
	COP(47F)	3.30
MMY-AP3366FT6P-UL	EER	10.7
	IEER	23.9
	COP(47F)	3.40
MMY-AP3606FT6P-UL	EER	9.7
	IEER	23.3
	COP(47F)	3.30
MMY-AP3846FT6P-UL	EER	9.7
	IEER	22.7
	COP(47F)	3.24
MMY-AP4086FT6P-UL	EER	9.6
	IEER	21.9
	COP(47F)	3.22
MMY-AP4326FT6P-UL	EER	9.7
	IEER	21.4
	COP(47F)	3.22
MMY-AP4566FT6P-UL	EER	9.3
	IEER	19.4
	COP(47F)	3.20

System with Non-ducted indoor units

Model name		
MMY-AP19256FT6P-UL	EER	11.7
	IEER	25.3
	COP(47F)	3.60
MMY-AP24056FT6P-UL	EER	10.7
	IEER	22.8
	COP(47F)	3.50
MMY-AP28856FT6P-UL	EER	10.3
	IEER	22.4
	COP(47F)	3.35
MMY-AP33656FT6P-UL	EER	10.1
	IEER	21.9
	COP(47F)	3.25

System with Ducted indoor units

Model name		
MMY-MAP0726FT6P-UL	EER	12.6
	IEER	19.5
	COP(47F)	3.42
MMY-MAP0966FT6P-UL	EER	11.7
	IEER	21.4
	COP(47F)	3.71
MMY-MAP1206FT6P-UL	EER	11.9
	IEER	20.0
	COP(47F)	3.48
MMY-MAP1446FT6P-UL	EER	11.4
	IEER	20.2
	COP(47F)	3.52
MMY-MAP1686FT6P-UL	EER	10.4
	IEER	19.2
	COP(47F)	3.24
MMY-AP1926FT6P-UL	EER	11.5
	IEER	20.4
	COP(47F)	3.67
MMY-AP2166FT6P-UL	EER	11.2
	IEER	20.5
	COP(47F)	3.74
MMY-AP2406FT6P-UL	EER	11.3
	IEER	20.8
	COP(47F)	3.56
MMY-AP2646FT6P-UL	EER	10.9
	IEER	20.5
	COP(47F)	3.46
MMY-AP2886FT6P-UL	EER	11.0
	IEER	20.2
	COP(47F)	3.46
MMY-AP3126FT6P-UL	EER	10.0
	IEER	19.7
	COP(47F)	3.29
MMY-AP3366FT6P-UL	EER	10.2
	IEER	20.7
	COP(47F)	3.32

System with Ducted indoor units

Model name		
MMY-AP3606FT6P-UL	EER	9.5
	IEER	20.2
	COP(47F)	3.37
MMY-AP3846FT6P-UL	EER	9.5
	IEER	19.8
	COP(47F)	3.27
MMY-AP4086FT6P-UL	EER	9.5
	IEER	19.4
	COP(47F)	3.27
MMY-AP4326FT6P-UL	EER	9.4
	IEER	19.0
	COP(47F)	3.20
MMY-AP4566FT6P-UL	EER	9.3
	IEER	18.9
	COP(47F)	3.20

Model name		
MMY-AP19256FT6P-UL	EER	11.3
	IEER	19.9
	COP(47F)	3.57
MMY-AP24056FT6P-UL	EER	10.5
	IEER	20.3
	COP(47F)	3.46
MMY-AP28856FT6P-UL	EER	9.8
	IEER	19.7
	COP(47F)	3.37
MMY-AP33656FT6P-UL	EER	9.5
	IEER	19.3
	COP(47F)	3.20

Efficiency values based on AHRI 1230 test method.

460 V, 3 phase Model

Efficiency Ratings

System with Non-ducted indoor units

Model name		
MMY-MAP0726FT9P-UL	EER	14.6
	IEER	26.6
	COP(47F)	3.67
MMY-MAP0966FT9P-UL	EER	12.5
	IEER	28.3
	COP(47F)	3.85
MMY-MAP1206FT9P-UL	EER	11.8
	IEER	27.5
	COP(47F)	3.61
MMY-MAP1446FT9P-UL	EER	12.2
	IEER	25.9
	COP(47F)	3.75
MMY-MAP1686FT9P-UL	EER	10.7
	IEER	23.3
	COP(47F)	3.44
MMY-AP1926FT9P-UL	EER	12.2
	IEER	26.1
	COP(47F)	3.70
MMY-AP2166FT9P-UL	EER	11.6
	IEER	24.2
	COP(47F)	3.57
MMY-AP2406FT9P-UL	EER	11.6
	IEER	23.3
	COP(47F)	3.60
MMY-AP2646FT9P-UL	EER	10.9
	IEER	23.1
	COP(47F)	3.40
MMY-AP2886FT9P-UL	EER	11.1
	IEER	22.8
	COP(47F)	3.45
MMY-AP3126FT9P-UL	EER	10.3
	IEER	22.1
	COP(47F)	3.30
MMY-AP3366FT9P-UL	EER	10.7
	IEER	23.9
	COP(47F)	3.40
MMY-AP3606FT9P-UL	EER	9.7
	IEER	23.3
	COP(47F)	3.30
MMY-AP3846FT9P-UL	EER	9.7
	IEER	22.7
	COP(47F)	3.24
MMY-AP4086FT9P-UL	EER	9.6
	IEER	21.9
	COP(47F)	3.22
MMY-AP4326FT9P-UL	EER	9.7
	IEER	21.4
	COP(47F)	3.22
MMY-AP4566FT9P-UL	EER	9.3
	IEER	19.4
	COP(47F)	3.20

System with Non-ducted indoor units

Model name		
MMY-AP19256FT9P-UL	EER	11.7
	IEER	25.3
	COP(47F)	3.60
MMY-AP24056FT9P-UL	EER	10.7
	IEER	22.8
	COP(47F)	3.50
MMY-AP28856FT9P-UL	EER	10.3
	IEER	22.4
	COP(47F)	3.35
MMY-AP33656FT9P-UL	EER	10.1
	IEER	21.9
	COP(47F)	3.25

System with Ducted indoor units

Model name		
MMY-MAP0726FT9P-UL	EER	12.6
	IEER	19.5
	COP(47F)	3.42
MMY-MAP0966FT9P-UL	EER	11.7
	IEER	21.4
	COP(47F)	3.71
MMY-MAP1206FT9P-UL	EER	11.9
	IEER	20.0
	COP(47F)	3.48
MMY-MAP1446FT9P-UL	EER	11.4
	IEER	20.2
	COP(47F)	3.52
MMY-MAP1686FT9P-UL	EER	10.4
	IEER	19.2
	COP(47F)	3.24
MMY-AP1926FT9P-UL	EER	11.5
	IEER	20.4
	COP(47F)	3.67
MMY-AP2166FT9P-UL	EER	11.2
	IEER	20.5
	COP(47F)	3.74
MMY-AP2406FT9P-UL	EER	11.3
	IEER	20.8
	COP(47F)	3.56
MMY-AP2646FT9P-UL	EER	10.9
	IEER	20.5
	COP(47F)	3.46
MMY-AP2886FT9P-UL	EER	11.0
	IEER	20.2
	COP(47F)	3.46
MMY-AP3126FT9P-UL	EER	10.0
	IEER	19.7
	COP(47F)	3.29
MMY-AP3366FT9P-UL	EER	10.2
	IEER	20.7
	COP(47F)	3.32

System with Ducted indoor units

Model name		
MMY-AP3606FT9P-UL	EER	9.5
	IEER	20.2
	COP(47F)	3.37
MMY-AP3846FT9P-UL	EER	9.5
	IEER	19.8
	COP(47F)	3.27
MMY-AP4086FT9P-UL	EER	9.5
	IEER	19.4
	COP(47F)	3.27
MMY-AP4326FT9P-UL	EER	9.4
	IEER	19.0
	COP(47F)	3.20
MMY-AP4566FT9P-UL	EER	9.3
	IEER	18.9
	COP(47F)	3.20

Model name		
MMY-AP19256FT9P-UL	EER	11.3
	IEER	19.9
	COP(47F)	3.57
MMY-AP24056FT9P-UL	EER	10.5
	IEER	20.3
	COP(47F)	3.46
MMY-AP28856FT9P-UL	EER	9.8
	IEER	19.7
	COP(47F)	3.37
MMY-AP33656FT9P-UL	EER	9.5
	IEER	19.3
	COP(47F)	3.20

Efficiency values based on AHRI 1230 test method.

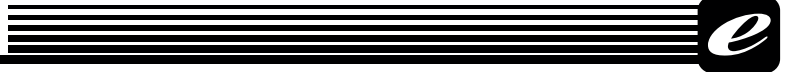

208 / 230 V , 1 phase Model

Efficiency Ratings

System with Non-ducted indoor units

Model name		
MMY-MAP0726FT2P-UL	EER	14.6
	IEER	26.6
	COP(47F)	3.67
MMY-AP1446FT2P-UL	EER	13.5
	IEER	25.7
	COP(47F)	3.77

System with Ducted indoor units

Model name		
MMY-MAP0726FT2P-UL	EER	12.6
	IEER	19.5
	COP(47F)	3.42
MMY-AP1446FT2P-UL	EER	12.2
	IEER	20.0
	COP(47F)	3.57

Efficiency values based on AHRI 1230 test method.

SHRM-e Engineering Data Book

Model name:

MMY-MAP__6FT6P-UL

MMY-MAP__6FT9P-UL

MMY-MAP__6FT2P-UL

May, 2021 Revised version