

Product Data

TABLE OF CONTENTS

INDUSTRY LEADING FEATURES / BENEFITS	1
MODEL NUMBER NOMENCLATURE	3
STANDARD FEATURES AND ACCESSORIES	4
DIMENSIONS	5
HORIZONTAL INSTALLATION CLEARANCES	7
MAINTENANCE CLEARANCES	7
SPECIFICATIONS	8
APPLICATION DATA	9
WIRING	9
CONTROL SYSTEM	10
WIRELESS REMOTE CONTROLLER	10
WIRED REMOTE CONTROLLER	10
AIR FLOW DATA	11
SOUND PRESSURE	11
SOUND POWER	12
FAN AND MOTOR SPECIFICATIONS	12
SETTING STATIC PRESSURE OR AUTOMATIC AIRFLOW ..	13
FAN PERFORMANCES AT VARYING STATIC PRESSURES .	14
WIRING DIAGRAMS	22
GUIDE SPECIFICATIONS	25

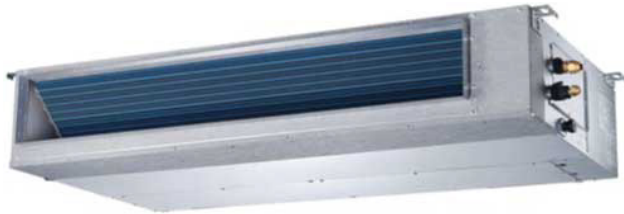

A220726

Fig. 1 — Sizes 09K - 48K

NOTE: The 09K-48K unit can be mounted vertically as well as horizontally.



A220727

Fig. 2 — Size 58K

NOTE: Images are for illustration purposes only. Actual models may differ slightly.

INDUSTRY LEADING FEATURES / BENEFITS

A PERFECT BALANCE BETWEEN BUDGET LIMITS, ENERGY SAVINGS AND COMFORT

The **40MBDQ** series ducted slim ductless systems are a matched combination of an outdoor condensing unit and an indoor fan coil unit connected only by refrigerant tubing and wires. The fan coil is mounted in the ceiling.

This selection of fan coils permits creative solutions to design problems such as:

- **Add-ons to current space (an office or family room addition)**
- **Special space requirements**
- **When changes in the load cannot be handled by the existing system**
- **Historical renovations or any application where preserving the look of the original structure is essential.**

These compact indoor fan coil units take up very little space above the ceiling. Advanced system components incorporate innovative technology to provide reliable cooling performance at low sound levels.

LOW SOUND LEVELS

When noise is a concern, the ductless split systems are the answer. The indoor units are whisper quiet. There are no compressors indoors, either in the conditioned space or directly over it, and there is none of the noise usually generated by air being forced through ductwork.

SECURE OPERATION

If security is an issue, outdoor and indoor units are connected only by refrigerant piping and wiring to prevent intruders from crawling through the ductwork. In addition, since outdoor units can be installed close to an outside wall, coils are protected from vandals and severe weather.

FAST INSTALLATION

This compact ductless system is simple to install. A mounting bracket and duct work is needed for the indoor units, and only wire and piping need run between the indoor and outdoor units. These units are fast and easy to install ensuring minimal disruption to customers in the home or workplace. This makes the ducted style ductless systems the equipment of choice, especially in retrofit situations.

SIMPLE SERVICING AND MAINTENANCE

Removing the top panel on the outdoor units provides immediate access to the control compartment, providing a service technician access to check unit operation. In addition, the draw-thru design of the outdoor section means that dirt accumulates on the outside surface of the coil. Coils can be cleaned quickly from the inside using a pressure hose and detergent.

On all indoor units, service and maintenance expense is reduced due to easy accessible service panels. In addition, these ducted systems have extensive self-diagnostics to assist in troubleshooting.

BUILT-IN RELIABILITY

Ducted style ductless system indoor and outdoor units are designed to provide years of trouble-free operation. The ducted indoor units include protection against freeze-up and high evaporator temperatures on heat pumps. The condensing units on the heat pumps are protected by a three minute delay that provides over-current protection and high temperature protection prior to the start of the compressor.

INDIVIDUAL ROOM COMFORT

Maximum comfort is provided because each space can be controlled individually based on the usage pattern. The provided air sweep feature permits optimal room air mixing to eliminate hot and cold spots for occupant comfort. In addition, year-round comfort can be provided with heat pumps.

ECONOMICAL OPERATION

The ducted style ductless system design allows individual or multi-room heating or cooling when required. There is no need to run large supply-air fans or chilled water pumps to handle a few spaces with unique load patterns.

EASY-TO-USE CONTROLS

The ducted units have microprocessor-based controls to provide the ultimate in comfort and efficiency. The user-friendly wired and wireless remote control provides the interface between the user and the unit.

BUILT-IN CONDENSATE LIFT PUMP

A factory installed condensate lift pump on the ducted fan coil provides installation flexibility.

VERTICAL OR HORIZONTAL INSTALLATION

Designed for maximum installation flexibility. The secondary drain (built-in) allows the unit to be mounted vertically allowing either a floor or ceiling-concealed installation depending on existing conditions (sizes 09K-48K only).

OPTIONAL WIRED CONTROLLER

Timer Function

STANDARD WIRED CONTROLLER

7 Day Programmable

SMART PHONE CONTROL (OPTIONAL)

The unit can be controlled via a smart phone with the addition of the Wi-Fi® Kit KSAIF0401AAA (sold separately).

24V INTERFACE (OPTIONAL)

The 24V Interface allows users to control the ductless system with a third party thermostat.

AGENCY LISTINGS

All systems are listed with AHRI (Air Conditioning, Heating & Refrigeration Institute), and ETL.

MODEL NUMBER NOMENCLATURE

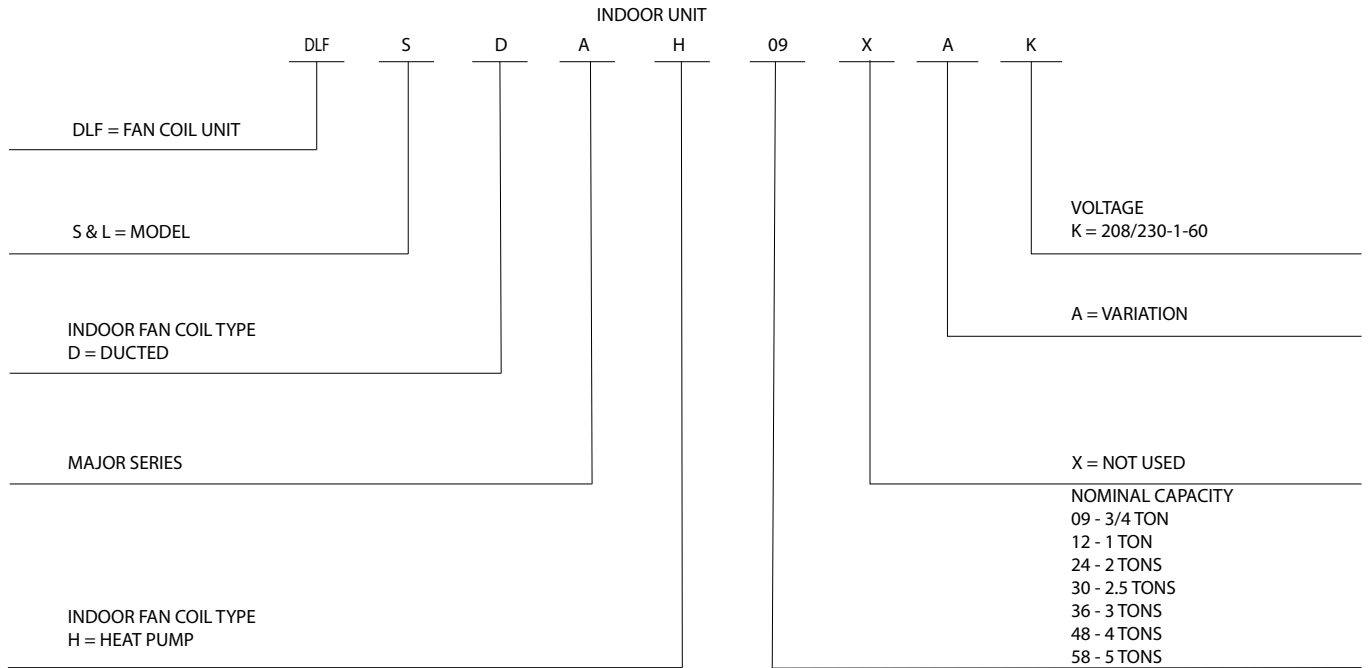

A220852



Use of the AHRI Certified TM Mark indicates a manufacturer's participation in the program For verification of certification for individual products, go to www.ahridirectory.org.

A220733

STANDARD FEATURES AND ACCESSORIES

Ease Of Installation	
Mounting Brackets	S
Low Voltage Controls	S
Comfort Features	
Rear or Bottom Return (Bottom Return only sizes 09K-48K)	S
Vertical (Up flow) or horizontal installation (Vertical only sizes 09K-48K)	S
Microprocessor Controls	S
Wired Remote Controller (7 Day Programmable KSACN0501AAA)	S
Wireless Remote Controller	S
Auto Restart Function	S
Cold Blow Protection on Heat Pumps	S
Freeze Protection Mode on Heat Pumps	S
Turbo Mode	S
Auto Changeover on Heat Pumps	S
Follow Me (Sense Temperature at remote)	S
Energy Saving Features	
Outside Air Intake	S
Sleep Mode	S
Stop/Start Timer	S
46° F Heating Mode (Heating Setback)	S
Safety And Reliability	
Indoor Coil Freeze Protection	S
Aluminum Golden Hydrophilic pre-coated fins	S
Indoor Coil High Temp Protection in Heating Mode	S
Ease Of Service And Maintenance	
Cleanable Filters	S
Diagnostics	S
Liquid Line Pressure Taps	S
Application Flexibility	
External Condensate Lift Pump shipped with the unit (sizes 09K-18K)	S
Built-in Condensate Lift Pump (sizes 24K-58K)	S

Legend

S - Standard

A - Accessory

ACCESSORIES

ORDERING NO.	DESCRIPTION	FOR MODELS
KSACN0101AAA	Optional Wired Remote Controller with Timer Function	All Sizes
KSALF0401AAA	Wi-Fi Kit	All Sizes
40VM900009	Optional Return Temperature Button Sensor - sold separately	All Sizes

HORIZONTAL OR VERTICAL (UP FLOW) INSTALLATION

Designed for maximum installation flexibility. The secondary drain (built-in) allows the unit to be mounted horizontally (sizes 09K-58K) or vertically (up flow) (sizes 09K-48K).

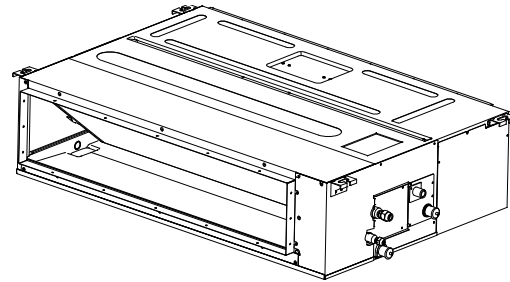

Fig. 3 — Unit mounted horizontally

A220735

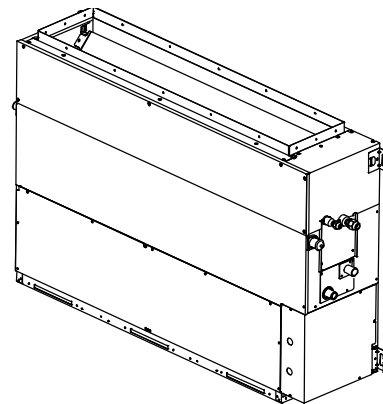

Fig. 4 — Unit mounted vertically (upflow)

A220736

DIMENSIONS

Size	Unit	OUTLINE DIMENSIONS				AIR OUTLET OPENING SIZE				AIR INLET OPENING SIZE			HANGER BRACKERS		REFRIGERANT PIPE LOCATIONS				OPERATING WEIGHT lb (kg)
		A	B	C	D	E	F	G	H	I	J	K	L	M	H1	H2	W1	W2	
9	In.	27.6	7.9	19.9	17.7	5.4	21.1	1.2	6	23.6	7.3	2	29.2	14.2	3.3	5.5	3.3	3.3	40
	mm	700	200	506	450	137	537	30	152	599	186	50	741	360	84	140	84	84	18.1
12	In.	27.6	7.9	19.9	17.7	5.4	21.1	1.2	6	23.6	7.3	2	29.2	14.2	3.3	5.5	3.3	3.3	40
	mm	700	200	506	450	137	537	30	152	599	186	50	741	360	84	140	84	84	18.1
18	In.	34.65	8.27	26.54	23.62	5.51	27.80	1.97	5.35	30.79	7.48	1.57	36.22	20	3.07	5.83	3.46	4.41	54
	mm	880	210	674	600	140	706	50	136	782	190	40	920	508	78	148	88	112	24.5
24	In.	43.31	9.8	30.47	27.56	5.51	36.46	1.97	6.89	39.41	8.98	0.2	44.88	23.54	3.15	5.91	5.12	6.1	87
	mm	1100	249	774	700	140	926	50	175	1001	228	5	1140	598	80	150	130	155	39.4
36	In.	53.54	9.8	30.47	27.56	5.51	46.69	1.97	6.89	49.65	8.98	0.2	55.12	23.54	3.15	5.91	5.12	6.1	106
	mm	1360	249	774	700	140	1186	50	175	1261	228	5	1400	598	80	150	130	155	48.3
48	In.	47.24	11.81	34.41	31.5	4.84	41.1	1.97	8.94	43.35	11.02	0.2	48.82	27.44	3.15	5.91	7.28	8.27	120
	mm	1200	300	874	800	123	1044	50	227	1101	280	5	1240	697	80	150	185	210	54.3
58	In.	55.12	17.32	33.78	30.31	4.17	46.81	1.1	15.16	46.54	11.02	1.57	56.57	27.56	8.15	10.75	5.67	5.67	163
	mm	1400	440	858	770	106	1189	28	385	1182	280	40	1437	700	207	273	144	144	74

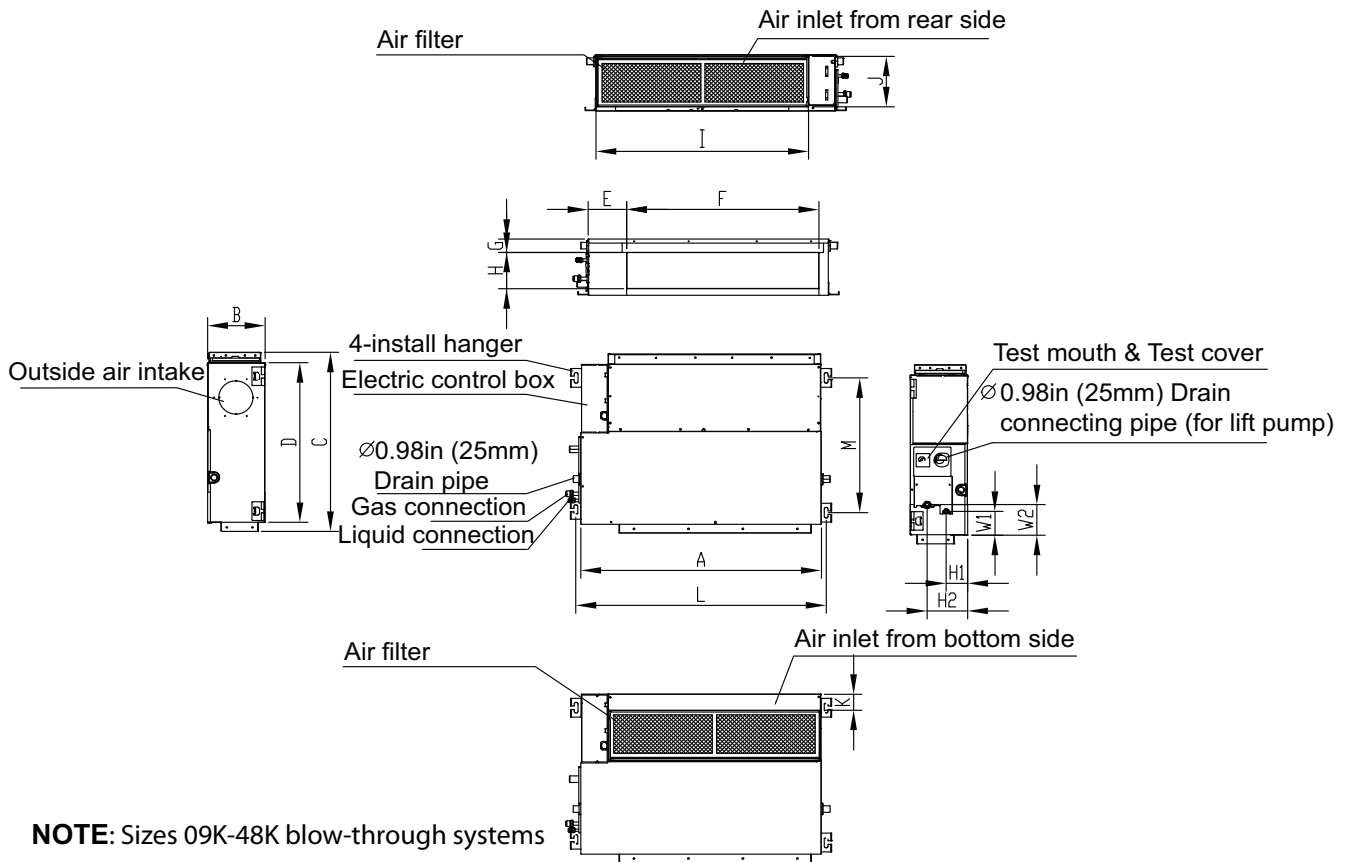

Fig. 5 — Indoor Unit Sizes 9K - 48K

A220737

DIMENSIONS (CONT)

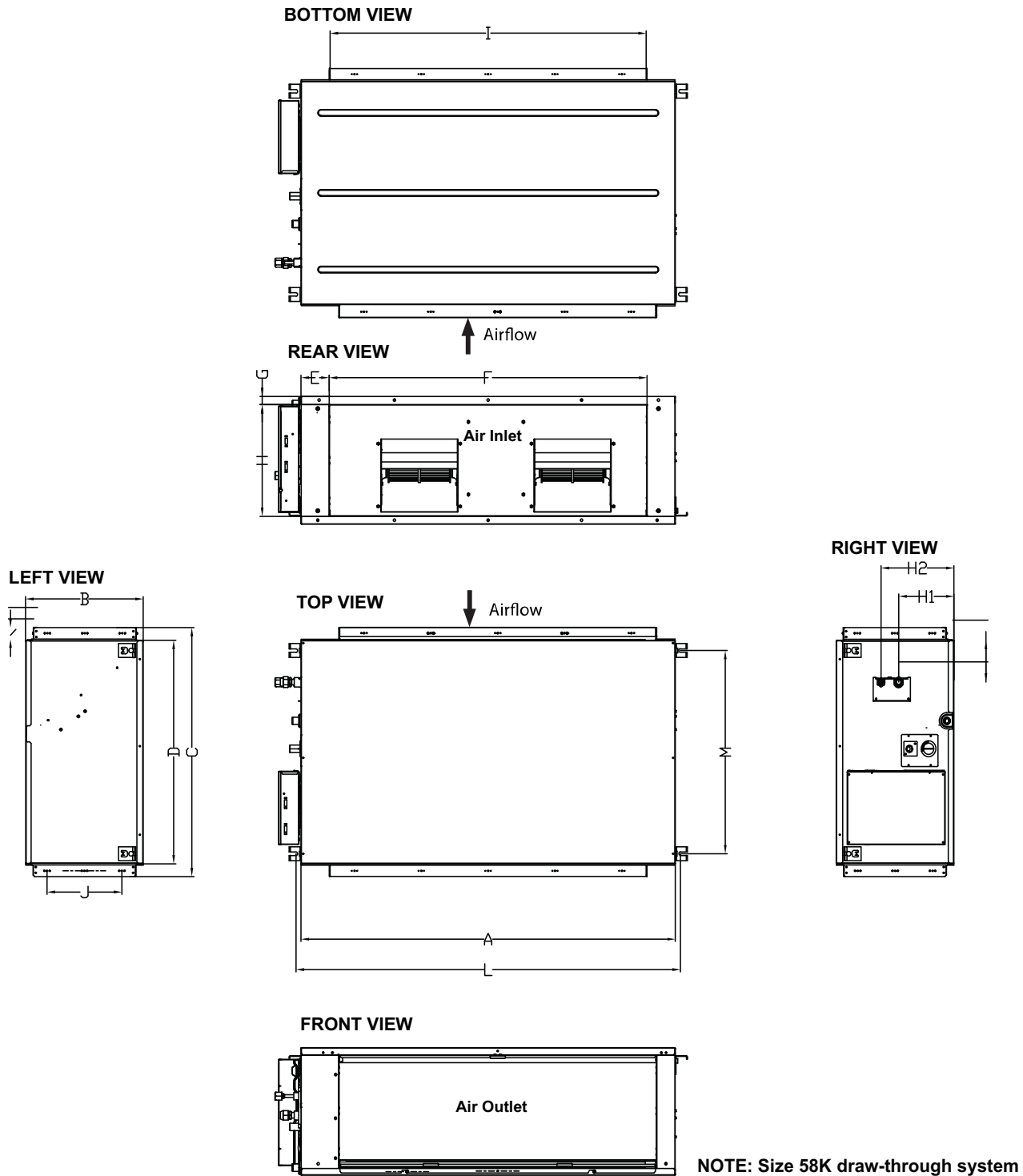

Fig. 6 — Indoor Unit Size 58K

A220738

HORIZONTAL INSTALLATION CLEARANCES

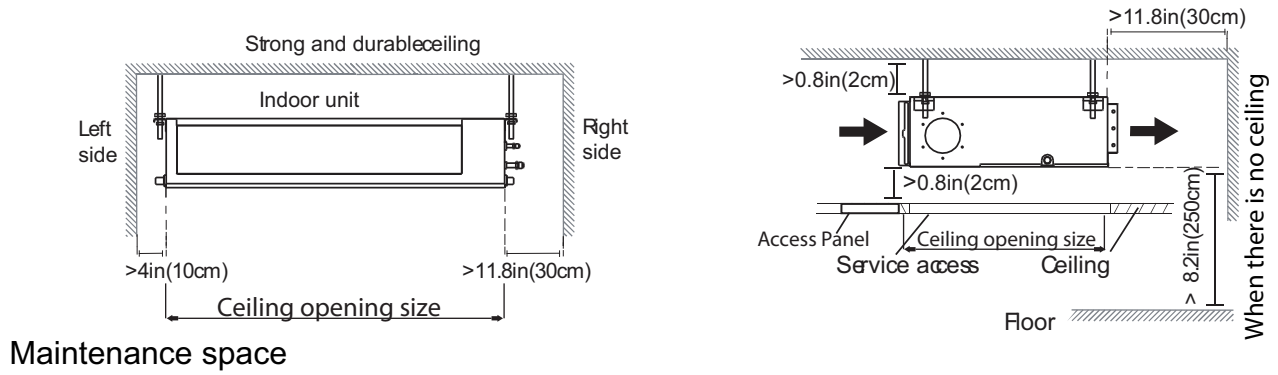

Fig. 7 —Installation Clearances

A220739

MAINTENANCE CLEARANCES

Maintenance clearances provide access for system inspections.

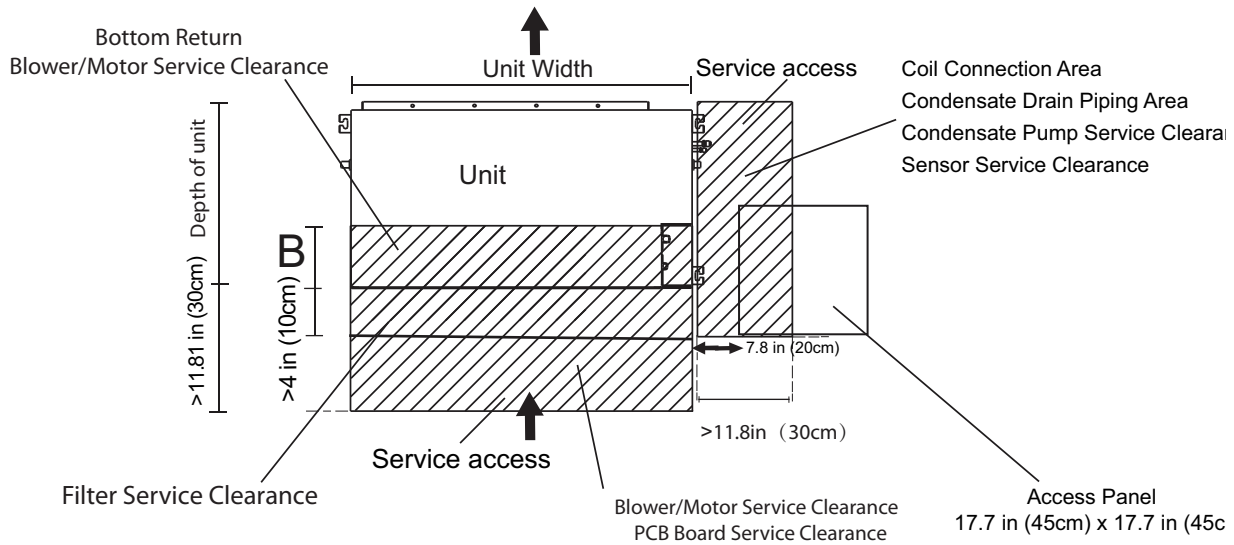

Fig. 8 —Maintenance Clearance

A220740

Capacity (Kbtu)	B
9K	11.81 in.(30cm)
12K	11.81 in.(30cm)
18K	11.81 in.(30cm)
24K	11.81 in.(30cm)
36K	11.81 in.(30cm)
48K	15.75in.(40cm)
58K	15.75in.(40cm)

NOTE: If installed above a fixed ceiling, utilize a ceiling access panel the length and width of the unit, otherwise the blower components and/or the entire unit cannot be removed.

If a single access panel is desired, the minimum dimensions should be:

- Single Access Panel Width: The width of the unit plus 2-inches on both sides
- Single Access Panel Length: The length of the unit plus 18-inches on the connection end and 2-inches on the opposite end.

SPECIFICATIONS

HEAT PUMP										
System	Size		09K	12K	18K	24K	36K	48K	58K	
	Indoor Model									
Electrical	Voltage, Phase, Cycle	V/Ph/Hz	208/230-1-60							
	Power Supply		Indoor unit powered from outdoor unit							
	MCA	A.	1.11	1.11	1.2	1.2	2.45	3.2	3.65	
Controls	Wireless Remote Controller (°F/°C Convertible)		Standard							
	Wired Remote Controller (°F/°C Convertible)		Standard							
Operating Range	Cooling Indoor DB Min - Max	°F (°C)	63~90 (17~32)	63~90 (17~32)	63~90 (17~32)	63~90 (17~32)	63~90 (17~32)	63~90 (17~32)	63~90 (17~32)	
	Heating Indoor DB Min - Max	°F (°C)	32~86 (0~30)	32~86 (0~30)	32~86 (0~30)	32~86 (0~30)	32~86 (0~30)	32~86 (0~30)	32~86 (0~30)	
Piping	Pipe Connection Size - Liquid	in (mm)	1/4 (6.35)	1/4 (6.35)	1/4 (6.35)	3/8(9.52)	3/8(9.52)	3/8(9.52)	3/8(9.52)	
	Pipe Connection Size - Suction	in (mm)	3/8 (9.52)	1/2 (12.7)	1/2 (12.7)	5/8(16)	5/8(16)	5/8(16)	3/4(19)	
Indoor Coil	Face Area	Sq.Ft.	1.2	1.2	1.9	2.9	3.7	4.2	5.9	
	No. Rows		3	3	3	3	4	4	4	
	Fins per inch		18	18	16	16	16	16	16	
	Circuits		3	3	4	7	7	8	9	
Indoor	Unit Width	in (mm)	27.559 (700)	27.559 (700)	34.65 (880)	43.31 (1100)	53.54 (1360)	47.24 (1200)	55.12 (1400)	
	Unit Height	in (mm)	7.874 (200)	7.874 (200)	8.27 (210)	9.8 (249)	9.8 (249)	11.81 (300)	11.81 (300)	
	Unit Depth	in (mm)	19.92 (506)	19.92 (506)	26.54 (674)	30.47 (774)	30.47 (774)	34.41 (874)	33.78 (858)	
	Net Weight	lbs (kg)	43.56 (19.8)	43.56 (19.8)	54 (24.5)	86.86 (39.4)	106.48 (48.3)	119.71 (54.3)	163 (74)	
	Fan Speeds		3	3	3	3	3	3	3	
	Airflow (lowest to highest)	CFM	180/228/337	211/295/397	365/453/557	553/689/955	803/964/1,233	1,150/1,348/1,576	1,579/1,931/2,481	
	Sound Pressure (lowest to highest)	db(A)	30/34/38	35/37/38	35/37/39	35.5/40/44	38.5/42/45.5	46/49.5/50.5	51/54/57	
	Max Static Pressure	In.WG.	0.2	0.2	0.40	0.64	0.64	0.64	0.80	
Field Drain Pipe Size O.D.	in (mm)	1 (25.4)	1 (25.4)	1 (25.4)	1 (25.4)	1 (25.4)	1 (25.4)	1 (25.4)		

*Performance may vary based on the outdoor unit matched to. See the compatible outdoor units product data for Performance Data.

NOTE: Backward compatible with single zone systems 38MAQ sizes 09K-24K, 38MBQ sizes 36K-48K and multi-zone systems 38MGQ.

NOTE: See the current compatibility chart for list of indoor unit and outdoor unit match ups.

APPLICATION DATA

UNIT SELECTION

Select equipment to either match or that can handle slightly less than the anticipated peak load. This provides better humidity control, fewer unit cycles, and less part-load operation.

For units used in spaces with high sensible loads, base equipment selection on unit sensible load, not on a total anticipated load. Adjust for anticipated room wet bulb temperature to avoid undersizing equipment.

UNIT MOUNTING (INDOOR)

Refer to the unit's installation instructions for further details.

Unit leveling - For reliable operation, units should be level in all planes.

Clearance - Provide adequate clearance for airflow (see figures 5 and 6).

Unit location - Select a location which provides the best air circulation for the room.

These units should be positioned as accessible as possible above the ceiling. The unit return and discharge should not be obstructed by furniture, curtains, or anything which may cause unit short cycling or air recirculation.

Duct the unit in the middle of the selected wall (if possible). Duct towards an outside wall, if available, to make piping easier, and position the unit so it faces the normal location of room occupants.

UNIT MOUNTING (OUTDOOR)

Refer to the unit's installation instructions for further details. Do not install the indoor or outdoor units in a location with special environmental conditions. For those applications, contact your ductless representative.

Mounting Template

Refer to the unit's installation instructions for further details.

SUPPORT

Adequate support must be provided to support the weight of all fan coils. Refer to the "SPECIFICATIONS" on page 8 for fan coil weights. Refer to "DIMENSIONS" on page 5 for the base unit dimensional drawings which contain the location of the mounting brackets.

SYSTEM OPERATING CONDITIONS

OPERATING RANGE Min/Max °F (°C)		
	Cooling	Heating
Indoor DB	63 / 90 (17 / 32)	32 / 86 (0 / 30)
Indoor WB	59 / 84 (15 / 29)	

NOTE: Reference the unit's installation instructions for more information.

DRAIN CONNECTIONS

Install the drains in compliance with the local sanitation codes. The standard ducted fan coil unit condensate lift pump has a maximum lift of 29.5 in. (750mm).

WIRING

Size all wires per the NEC (National Electrical Code) or CEC (Canadian Electrical Code) and local codes. Use the electrical data from the outdoor unit (MCA - minimum circuit amps and MOCP - maximum over current protection), to correctly size the wires and the disconnect fuse or breakers respectively.

SIZES 09-24 RECOMMENDED CONNECTION METHOD FOR POWER AND COMMUNICATION WIRING

Power and Communication Wiring: The main power is supplied to the outdoor unit. The field supplied 14/3 power/communication wiring, from the outdoor unit to the indoor unit, consists of four (4) wires and provides the power for the indoor unit. Two wires are high voltage AC power, one is communication wiring and the other is a ground wire.

To minimize communication interference: If installed in a high Electromagnetic field (EMF) area and communication issues arise, a 14/2 stranded shielded wire can be used to replace L2 and (S) between the outdoor and indoor units - landing the shield onto the ground in the outdoor unit only.

Wiring Sizes 09-24

Cable	Cable Size	Remarks
Connection Cable	14AWG	3 wire + Ground 1Φ 208/230 V (Stranded wire is recommended)

SIZES 36-58 RECOMMENDED CONNECTION METHOD FOR POWER AND COMMUNICATION WIRING

Power and Communication Wiring: The main power is supplied to the outdoor unit. The field supplied power wiring from the outdoor unit to the indoor unit consists of three (3) wires and provides the power for the indoor unit. Two wires are high voltage AC power and one is a ground wire. To minimize voltage drop, the factory recommended wire size is 14/2 stranded with a ground.

Communication Wiring: A separate shielded stranded copper conductor only, with a 600 volt rating and double insulated copper wire, must be used as the communication wire from the outdoor unit to the indoor unit. Please use a separate shielded 16GA stranded control wire.

Wiring Sizes 36-58

Cable	Cable Size	Remarks
Power Connection Cable	14AWG	2 wire + Ground 1Φ 208/230V
Communication Cable	16AWG	2 wire stranded shielded control wire



CAUTION

EQUIPMENT DAMAGE HAZARD

Failure to follow this caution may result in equipment damage or improper operation. Wires should be sized based on NEC and local codes.



CAUTION

EQUIPMENT DAMAGE HAZARD

Failure to follow this caution may result in equipment damage or improper operation. Be sure to comply with local codes while running wire from the indoor unit to the outdoor unit. Every wire must be connected firmly. Loose wiring may cause the terminal to overheat or result in unit malfunction. A fire hazard may also exist. Ensure all wiring is tightly connected. No wire should touch the refrigerant tubing, compressor or any moving parts.

Disconnecting means must be provided and must be located within sight and readily accessible from the system. Connecting cable with conduit must be routed through the hole in the conduit panel.

CONTROL SYSTEM

The indoor unit is equipped with a microprocessor control to perform two functions:

1. Provide safety for the system
2. Control the system and provide optimum levels of comfort and efficiency.

The main microprocessor is located on the control board of the fan coil unit (outdoor units have a microprocessor also) with thermistors located in the fan coil air inlet and on the indoor coil. Heat pump units have a thermistor on the outdoor coil. These thermistors monitor the system's operation to keep the unit within acceptable parameters and control the operating mode.

WIRELESS REMOTE CONTROLLER

1. A wireless remote controller is supplied for system operation of all ducted units.
2. Each battery operated wireless (infrared) remote controller may be used to control more than one unit.



Fig. 9 —Wireless Remote Controller

A220744

WIRED REMOTE CONTROLLER

- P/N KSACN0101AAA (optional available as an accessory)
- P/N KSACN0501AAA (included with the Unit)

1. Wired remote controller used for system operation of all ducted units.
2. Kit includes a wired remote controller and a connecting cable.

NOTE: Extension wire available through RCD (KSACN0101AAA Part Number: 17401204001601; KSACN0501AAA Part Number: 17401204000769).

3. Connect the wire terminal between the remote controller and the indoor unit.
4. Display in °F or °C and temperature increments every 1°F or every 1°C.



Fig. 10 —KSACN0101AAA (Timer Function)

A220745



Fig. 11 —KSACN0501AAA (7 Day Programmable)

A220746

24 INTERFACE (OPTIONAL)

Allows the ductless system to be controlled using a third party thermostat P/N KSAIC0301230 (option available as an accessory).

SMART PHONE CONTROL (OPTIONAL)

A Wi-Fi® Kit, used for system operation of all ducted units through a smart phone (P/N KSAIF0401AAA), is available (option available as an accessory).

AIR FLOW DATA

System Size		9K	12K	18K	24K	36K	48K	58K
Indoor (CFM)	High	337	397	557	955	1,233	1,576	2,481
	Medium	228	295	453	689	964	1,348	1,931
	Low	180	211	365	553	803	1,150	1,579

SOUND PRESSURE

System Size		9K (208/230V)	12K (208/230V)	18K (208/230V)	24K (208/230V)	36K (208/230V)	48K (208/230V)	58K (208/230V)
Cooling Operation Indoor Sound Pressure	dBa at (High/ Med/Low CFM)	38/34/30	39/37/35	39/37/35	44/40/35.5	45.5/42/38.5	50.5/49.5/46	58.3/57.3/53.9/51.2
Heating Operation Indoor Sound Pressure	dBa at (High/ Med/Low CFM)	39/35/31	37/36/34	37/36/34	41.9/39.2/36.7	45.4/43/39.4	50.1/48.5/45.3	56.9/56.9/53.7/50.6

SOUND PRESSURE TESTING METHOD

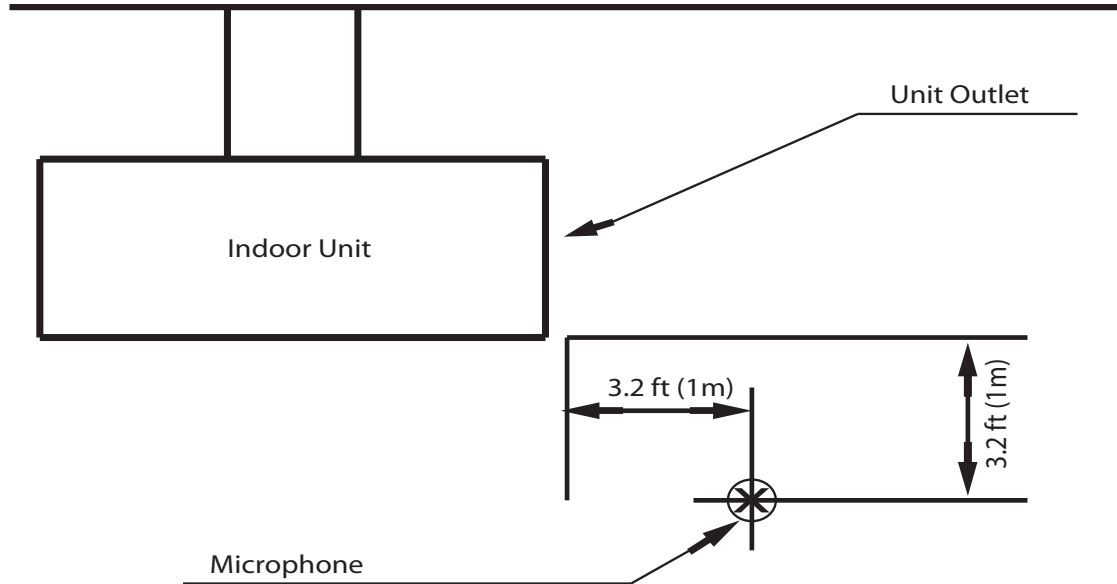

Fig. 12 —Sound Pressure Testing Method

A220747

SOUND POWER

System Size		9K (208/230V)	12K (208/230V)	18K (208/230V)	24K (208/230V)	36K (208/230V)	48K (208/230V)	58K (208/230V)
Cooling Operation Indoor Sound Power	dBA (@ High CFM)	55.4	59.5	64	66.9	69.6	70.4	76.2
Heating Operation Indoor Sound Power	dBA (@ High CFM)	60.2	63.3	62.6	68.2	70.8	71.6	74.1
Cooling Operation Indoor Sound Power (Turbo Mode)	dBA (@ High CFM)	54.4	58.5	63	65.9	68.6	69.4	75.2
Heating Operation Indoor Sound Power (Turbo Mode)	dBA (@ High CFM)	59.2	62.3	61.6	67.2	69.8	70.6	73.1

FAN AND MOTOR SPECIFICATIONS

Ducted		9K	12K	18K	24K	36K	48K	58K	
		(208/230V)	(208/230V)	(208/230V)	(208/230V)	(208/230V)	(208/230V)	(208/230V)	
Indoor Fan	Material	Plastic	Plastic	Metal	Metal	Metal	Metal	Metal	
	Type	LX-154*158* 15-41J	LX-154*158* 15-41J	FLBJ-150*158* 12-41	FLBJ-200*198* 12-46	FLBJ-200*266* 12.7-46	FLBJ-230*264* 12.7-40	FLBJ-227*234* 12.7-43	
	Diameter	inch	5.9	5.9	6.06 inch	7.87 inch	7.87 inch	9.06 inch	8.94
	Height	inch	5.9	5.9	6.22 inch	7.80 inch	10.47 inch	10.39 inch	9.21
Indoor Fan Motor	Model	ZKFN-55-8-22	ZKFN-55-8-22	ZKFN-160-8-1-2	ZKFN-160-8-1-2	ZKFN-300-8-1	ZKFN-560-8-1-1	ZKFN-700-8-1	
	Volts	V	208/230	208/230	208/230	208/230	208/230	208/230	
	Type		DC	DC	DC	DC	DC	DC	
	Phase		3	3	3	3	3	3	
	FLA		1.11	1.11	1.65	1.65	2.45	4.1	3.65
	Insulation class		E	E	E	E	E	E	B
	Safe class		IPX0	IPX0	IPX0	IPX0	IPX0	IPX0	IPX0
	Input	W	130	130	200	200	420	560	1000
	Output	W	55	55	160	160	300	560	700
	Range of current	Amps	1±10%	1±10%	1.2±10%	1.2±10%	2.45±10%	3.2±10%	3.65±10%
	Rated current	Amps	1.11	1.11	1.2	1.2	2.45	3.2	3.65
	Rated HP	HP	0.18	0.18	0.27	0.27	0.56	0.75	0.952
	Speed	rev/min	1100-1350	1100-1350	850/700/450	880/820/690	1130/1050/990	890/820/840	1060/910/790
Rated RPM	rev/min	1350	1350	1300	1300	1280	1020	1060	
Max. input	W	130	130	160	160	420	560	1000	

SETTING STATIC PRESSURE OR AUTOMATIC AIRFLOW

The indoor ducted units can be programmed for different static pressure settings or airflows; the factory default setting is SP1. Use the following steps to set the static pressure or Automatic Airflow using the Wired Remote Controller or the Wireless Remote Controller according to the installation conditions.

WHEN USING THE KSACN0501AAA WIRED CONTROLLER:

- The external static pressure can be manually changed to the fan curves SP2, SP3, SP4.
- Choose the Automatic Airflow “AF” adjustment function to automatically identify the static pressure and regulate the airflow amount.

Follow these instructions to configure:

1. Ensure the test run is done with a dry coil. If the coil is not dry, run the unit for 2 hours in the **FAN ONLY** mode to dry the coil.
2. Check that both the power supply wiring and the duct installation have been completed. Ensure the dampers are properly positioned. Check that the air filter is properly attached to the unit’s air return side passage.
3. If there is more than one air inlet and/or outlet, adjust the dampers so that the airflow rate of each air inlet and outlet conforms to the designed airflow rate. Ensure the unit is in **FAN ONLY** mode. Press and set the Airflow Adjustment “AF” on the remote controller to adjust the airflow rate from **H** to **L**. Turn the indoor unit **OFF** with the Wired Controller.
4. Set the parameters for airflow adjustment.

When the system is **OFF**, perform the following steps:

- a. Press and hold **COPY** for approximately 4 seconds
- b. Press “+” or “-” to scroll through the menu to select either **SP** or **AF**.

NOTE: T1, T2, T2b, T3, T4 are sub-menus for thermistors. **DO NOT** select to set the external static pressure.

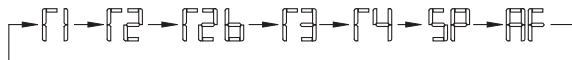
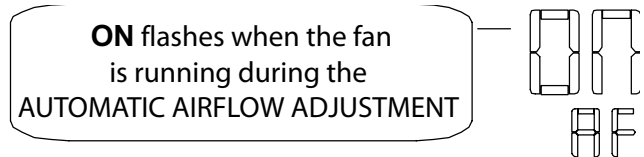

Fig. 13 — Wired Controller Menu Selection

1. If setting the external static pressure manually, select **SP** and press **CONFIRM**. Select the **SP** number (SP1, SP2, SP3, SP4 – see Table “FAN PERFORMANCES AT VARYING STATIC PRESSURES” on page 14 and curves (Figs. 15 through 21)). Power down the unit to lock in the selection.
2. If choosing the **AUTOMATIC AIRFLOW ADJUSTMENT** function, select **AF** and press **CONFIRM**. The system starts the fan for the **AUTOMATIC AIRFLOW ADJUSTMENT**. The **ON** indicator flashes when the fan runs during the **AUTOMATIC AIRFLOW ADJUSTMENT**. After 3 to 6 minutes, the system stops operating once the **AUTOMATIC AIRFLOW ADJUSTMENT** is complete.



A220756

Fig. 14 —Automatic Airflow ON signal

NOTE: The external static pressure can also be selected using the wireless remote controller (RG57F3(B)/BGEFU1), included with the indoor unit, by pointing it toward the indoor unit’s Infrared Receiver typically located inside the control box. Refer to the wireless remote controller service manual for further instructions.

⚠ CAUTION

Do not use the **AUTOMATIC AIRFLOW ADJUSTMENT** with the remote control if using booster fans, an outdoor air processing unit, or a HRV via duct. If the ductwork or static pressure have been changed, review “SETTING STATIC PRESSURE OR AUTOMATIC AIRFLOW” on page 13 and follow steps 3 and 4.

WHEN USING THE 24V INTERFACE KSAIC**

The wireless remote controller, wired controllers KSACN** and Wi-Fi kits are disabled. Since a wired controller is required to setup the static pressure of the indoor ducted units, the 24V interface must be temporarily bypassed using the steps below:

1. Turn off the power to the unit
2. On the 24V interface, disconnect the plugs from the CN11 (to Outdoor) and CN12 (to Indoor) connections.
3. **Sizes:**
 - a. **For sizes 9K-24K only:** Add a jumper between the indoor S terminal to the outdoor S terminal.
 - b. **For sizes 36K-58K only:** Disconnect S1 and S2 from the 24V interface (CN8 and CN9) and splice together **S1** from outdoor to **S1** from indoor and **S2** from outdoor to **S2** from indoor.
4. Connect the Wired Controller (**KSACN0501AAA**) and follow the external static pressure setup.
5. Once the static pressure is adjusted, disconnect the wired controller
6. **Sizes:**
 - a. **For sizes 9K-24K only:** Remove the S jumper from the terminal block.
 - b. **For sizes 36K-58K only:** Remove the splice and reconnect **S1** and **S2** back to the 24V interface accordingly.
7. Reconnect the plugs back to CN11 (to outdoor) and CN12 (to indoor) accordingly.
8. Restore power to the unit.

NOTE: When a system is using the 24V interface, the indoor unit’s fan speed defaults to **AUTO** with the indoor unit’s default logic.

FAN PERFORMANCES AT VARYING STATIC PRESSURES

Size	Units	Static Pressure AT Rated Point				Static Pressure Range
		SP1	SP2	SP3	SP4	
9	In. WG	0.068	0.104	0.128	0.176	0~0.20
	Pa	17	26	32	44	(0~50)
12	In. WG	0.064	0.10	0.136	0.20	0~0.20
	Pa	16	25	34	50	(0~50)
18	In. WG	0.096	0.168	0.288	0.392	0~0.40
	Pa	24	42	72	98	(0~100)
24	In. WG	0.10	0.216	0.336	0.528	0~0.64
	Pa	25	54	84	132	(0~160)
36	In. WG	0.168	0.312	0.48	0.62	0~0.64
	Pa	42	78	120	155	(0~160)
48	In. WG	0.18	0.404	0.616	0.64	0~0.64
	Pa	45	101	154	160	(0~160)
58	In. WG	0.296	0.416	0.584	0.8	0~0.80
	Pa	74	104	146	200	(0~200)
Factory Setting		√				

AIRFLOW AT RATED POINT

System Size		9	12	18	24	36	48	58
High	CFM	337	397	557	955	1,233	1,576	2,481
Medium	CFM	228	295	453	689	964	1,348	1,931
Low	CFM	180	211	365	553	803	1,150	1,579

FAN PERFORMANCES AT VARYING STATIC PRESSURES (CONT)

Air volume m3/h(CFM) SP1

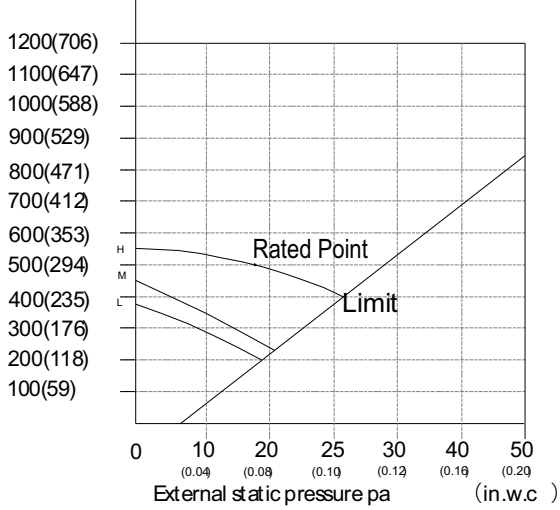

Air volume m3/h(CFM) SP2

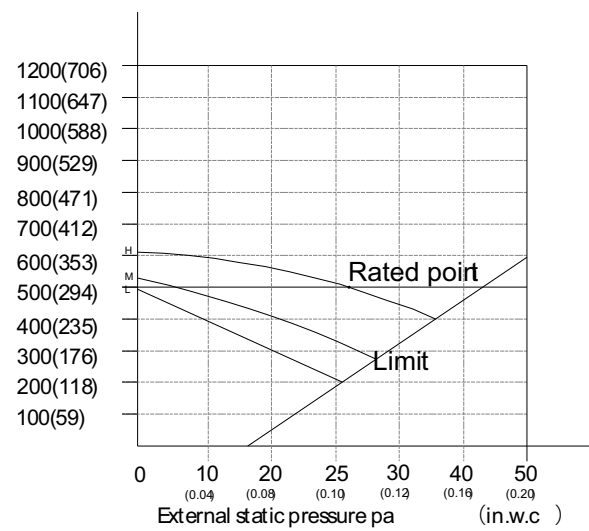

Air volume m3/h(CFM) SP3

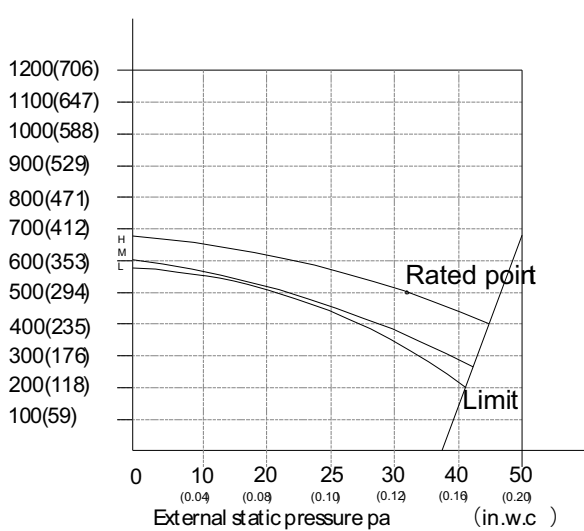

Air volume m3/h(CFM) SP4

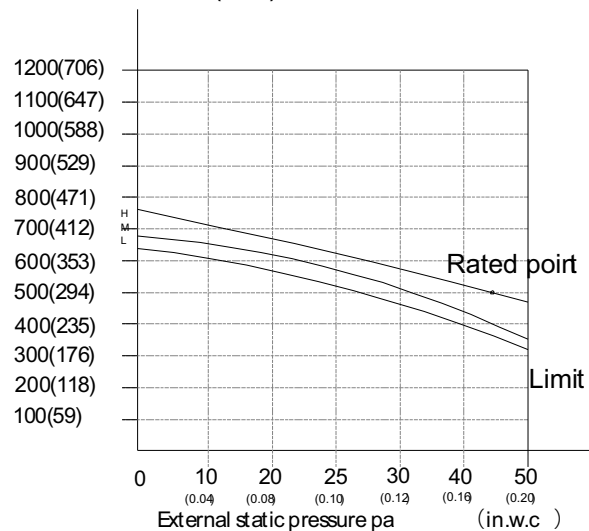

Fig. 15 —Size 9

A220757

FAN PERFORMANCES AT VARYING STATIC PRESSURES (CONT)

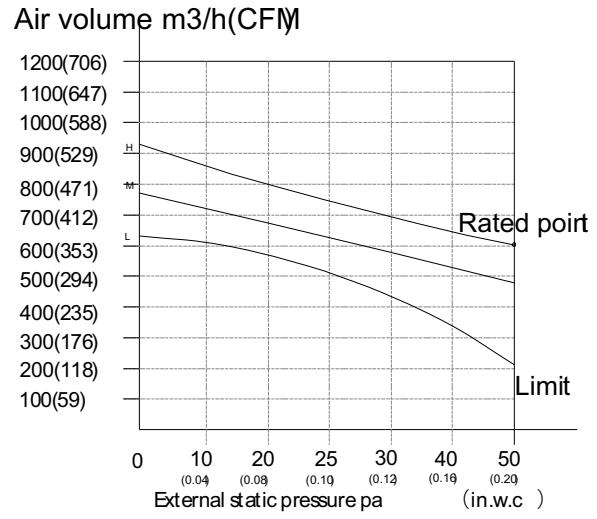
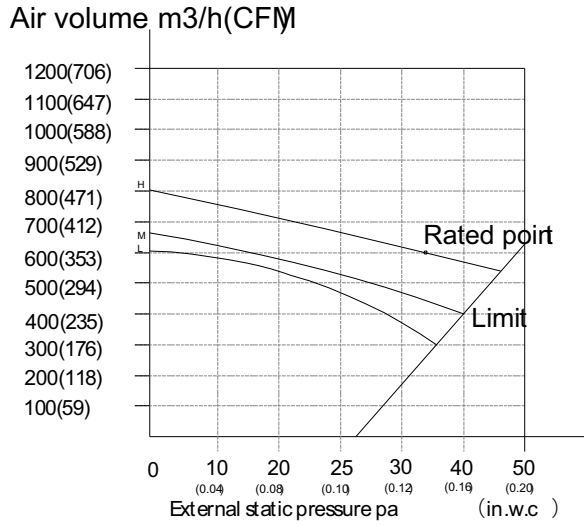
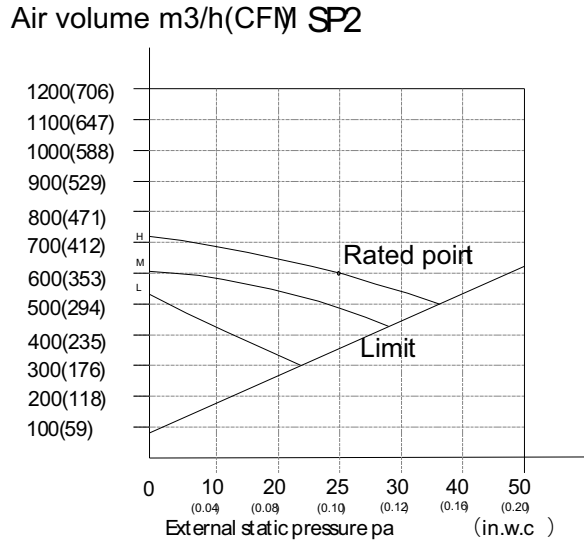
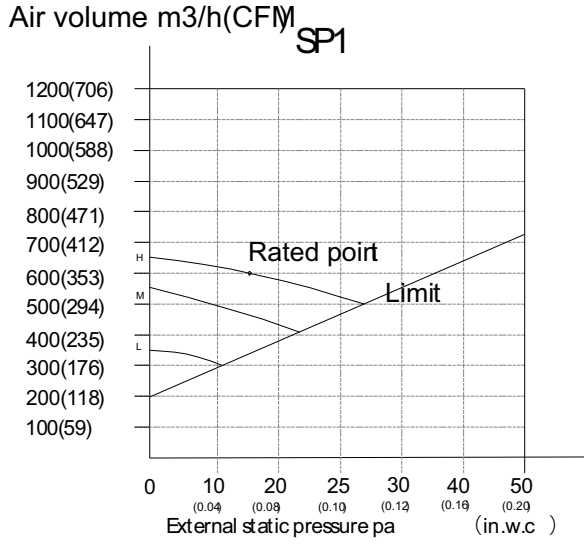
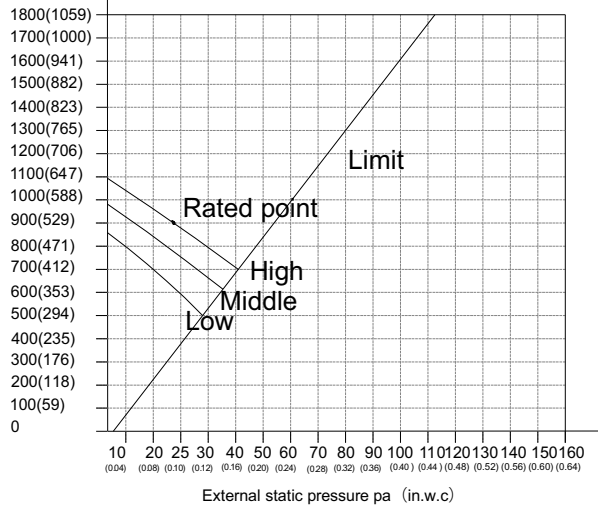

Fig. 16 —Size 12

A220758

FAN PERFORMANCES AT VARYING STATIC PRESSURES (CONT)

Air volume m3h(CFM) SP1



Air volume m3h(CFM) SP2

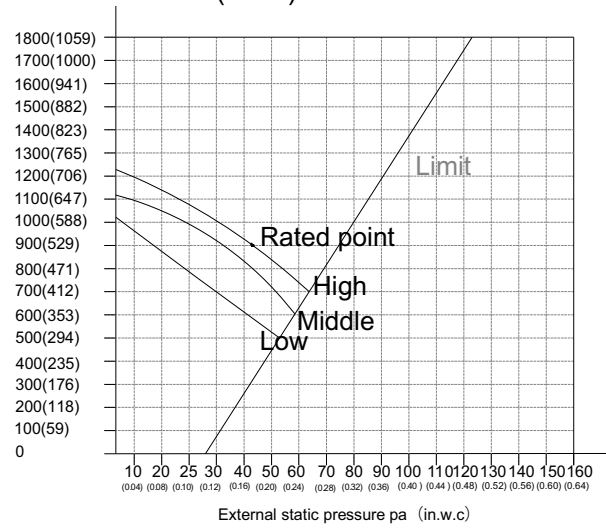

Air volume m3h(CFM) SP3

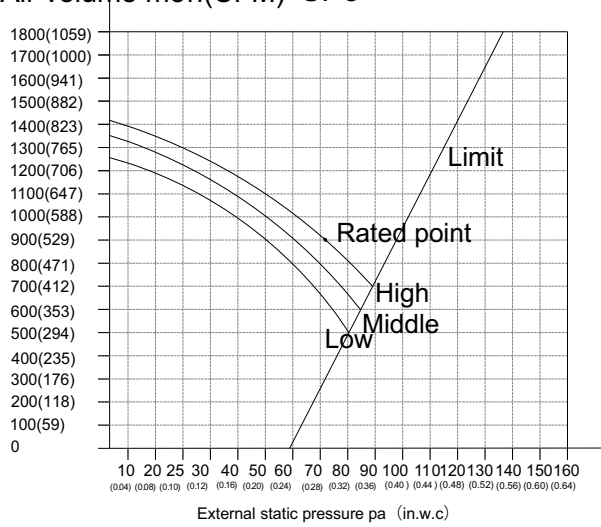

Air volume m3h(CFM) SP4

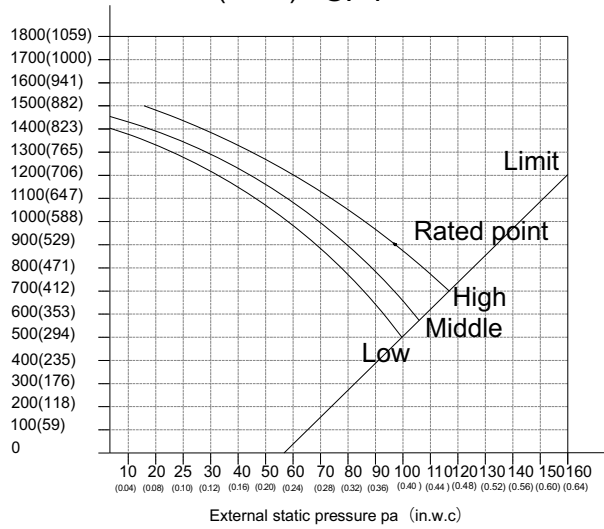
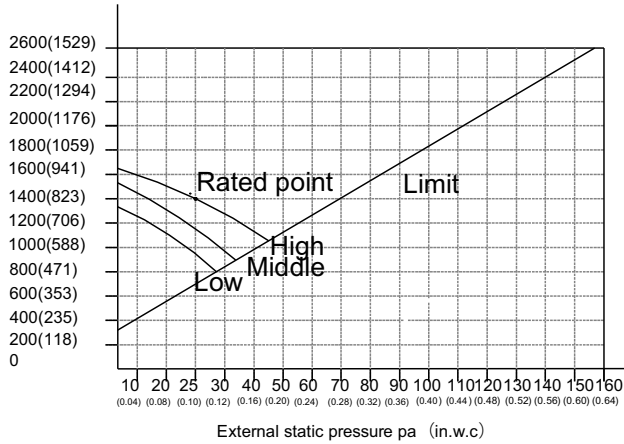

Fig. 17 —Size 18

A220759

FAN PERFORMANCES AT VARYING STATIC PRESSURES (CONT)

Air volume m3h(CFM) SP1



Air volume m3h(CFM) SP2

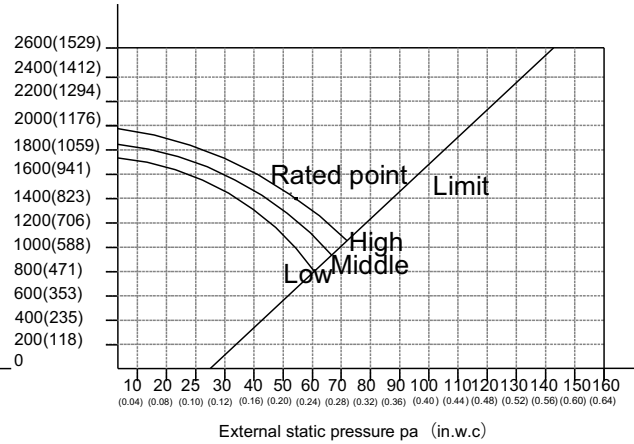

Air volume m3h(CFM) SP3

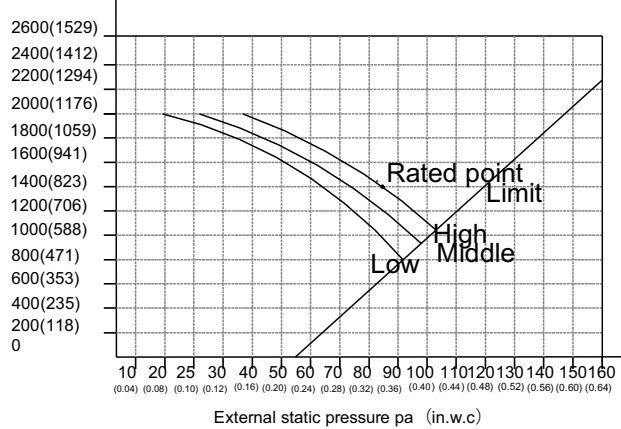

Air volume m3h(CFM) SP4

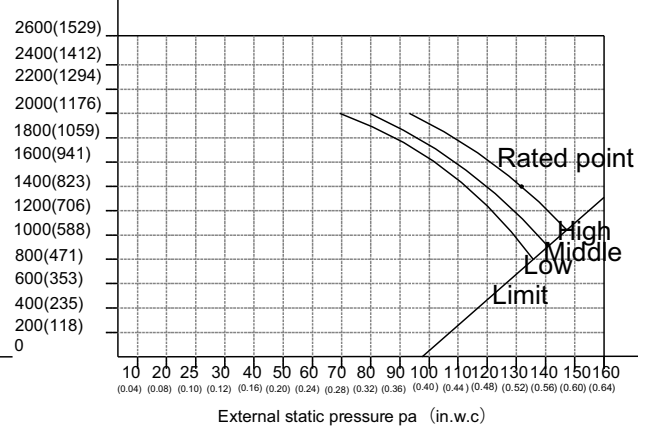
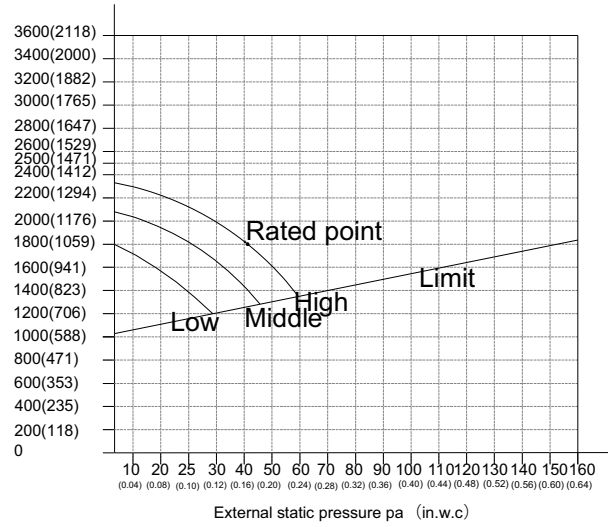

Fig. 18 —Size 24

A220760

FAN PERFORMANCES AT VARYING STATIC PRESSURES (CONT)

Air volume m3h(CFM) SP1



Air volume m3h(CFM) SP2

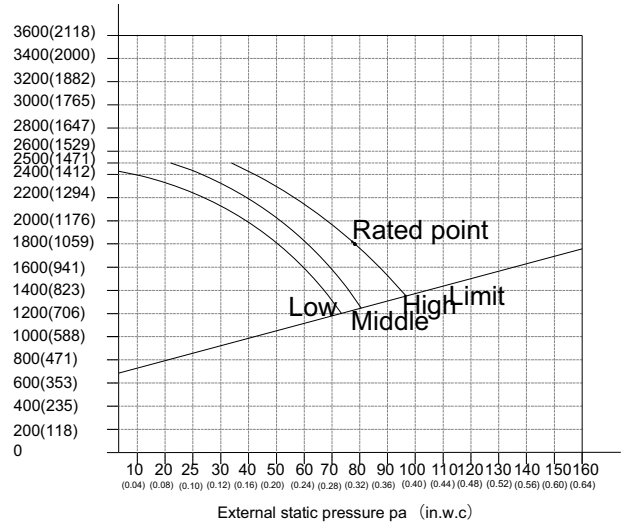

Air volume m3h(CFM) SP3

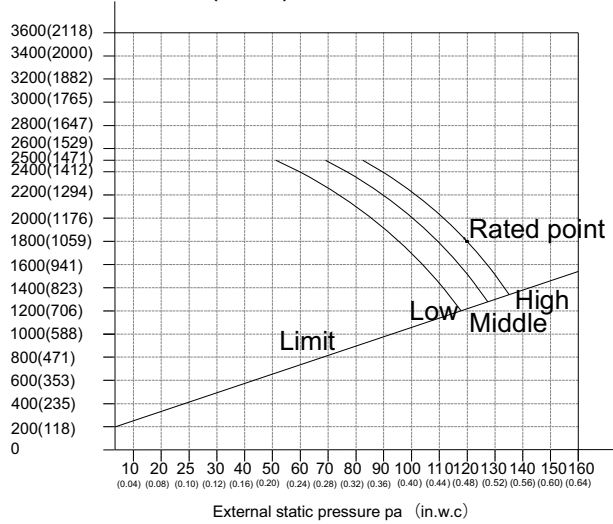

Air volume m3h(CFM) SP4

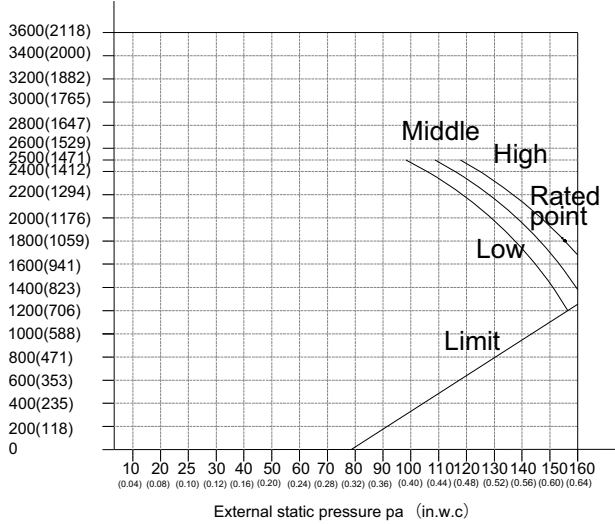
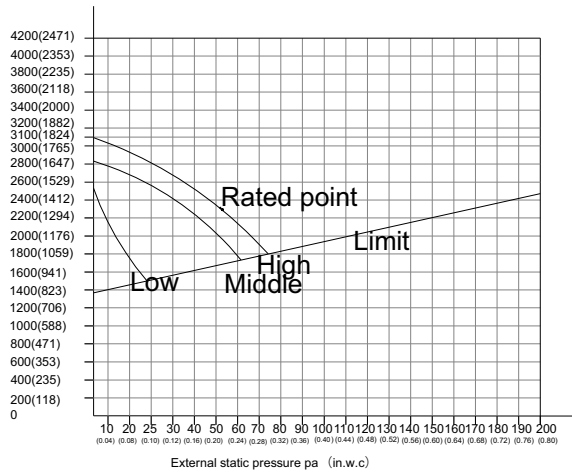

Fig. 19 —Size 36

A220761

FAN PERFORMANCES AT VARYING STATIC PRESSURES (CONT)

Air volume m3h(CFM) SP1



Air volume m3h(CFM) SP2

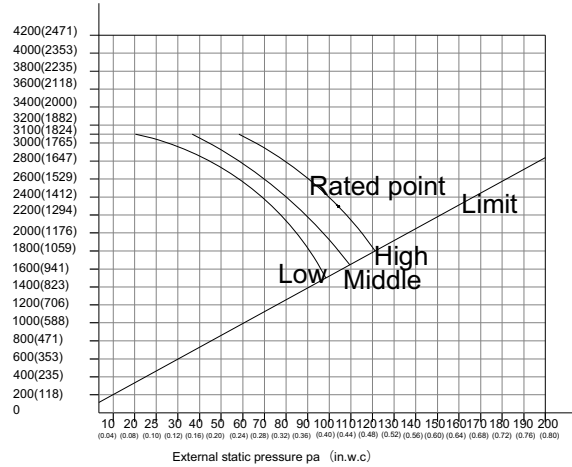

Air volume m3h(CFM) SP3

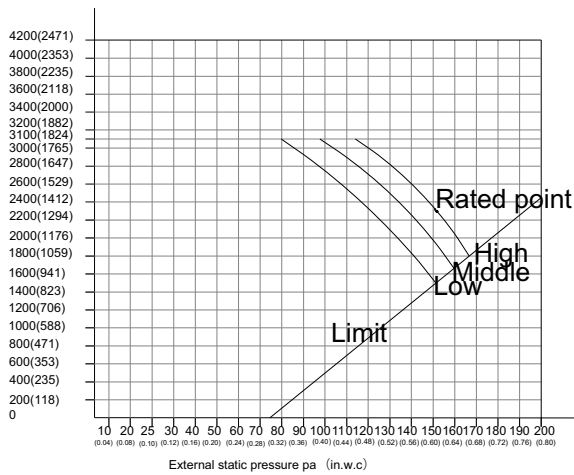

Air volume m3h(CFM) SP4

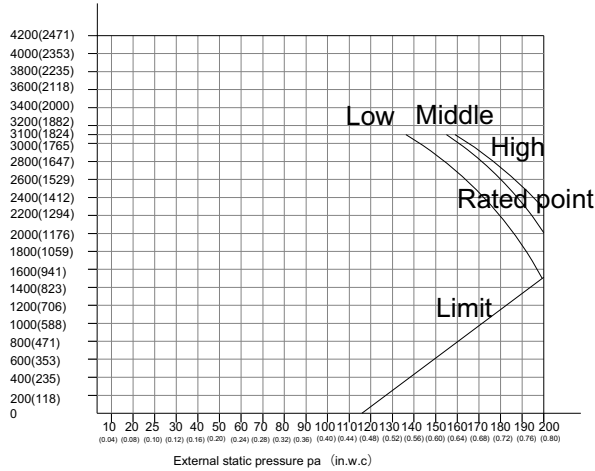
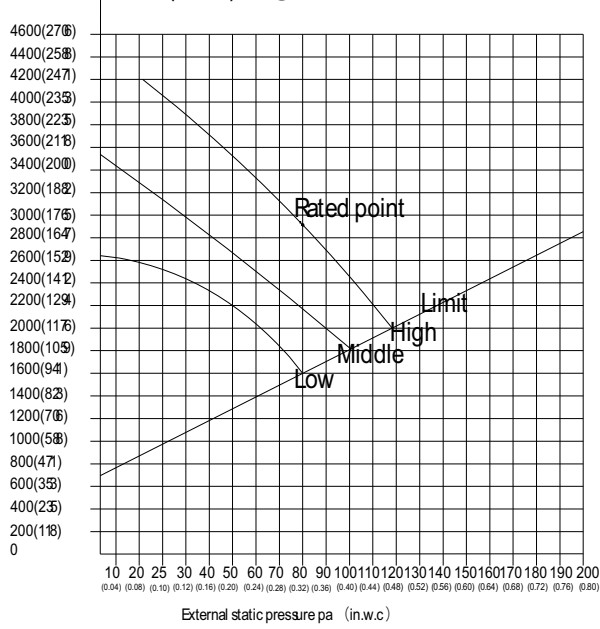

Fig. 20 —Size 48

A220762

FAN PERFORMANCES AT VARYING STATIC PRESSURES (CONT)

Air volume m³h(CFM) SP1



Air volume m³h(CFM) SP2

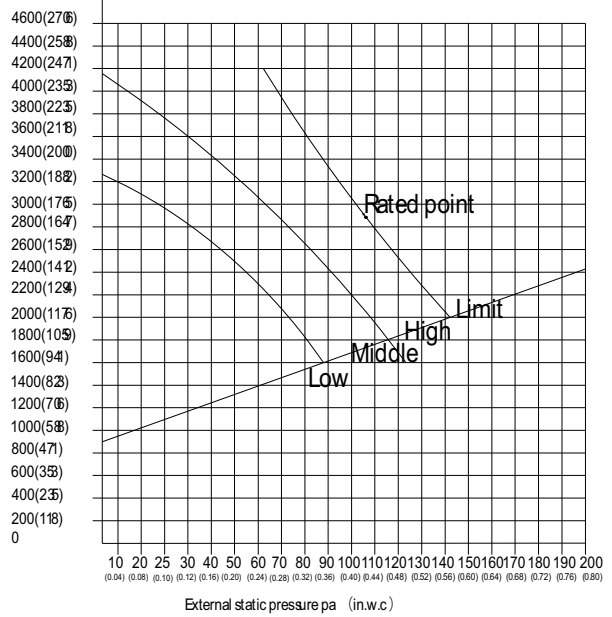

Air volume m³h(CFM) SP3

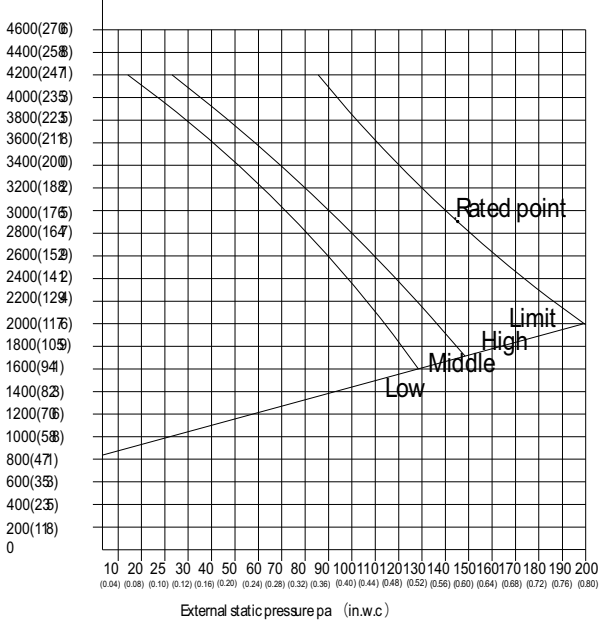

Air volume m³h(CFM) SP4

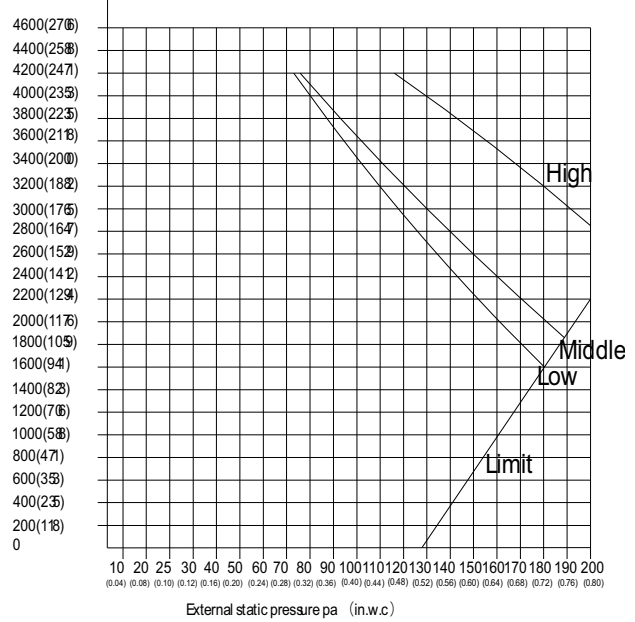
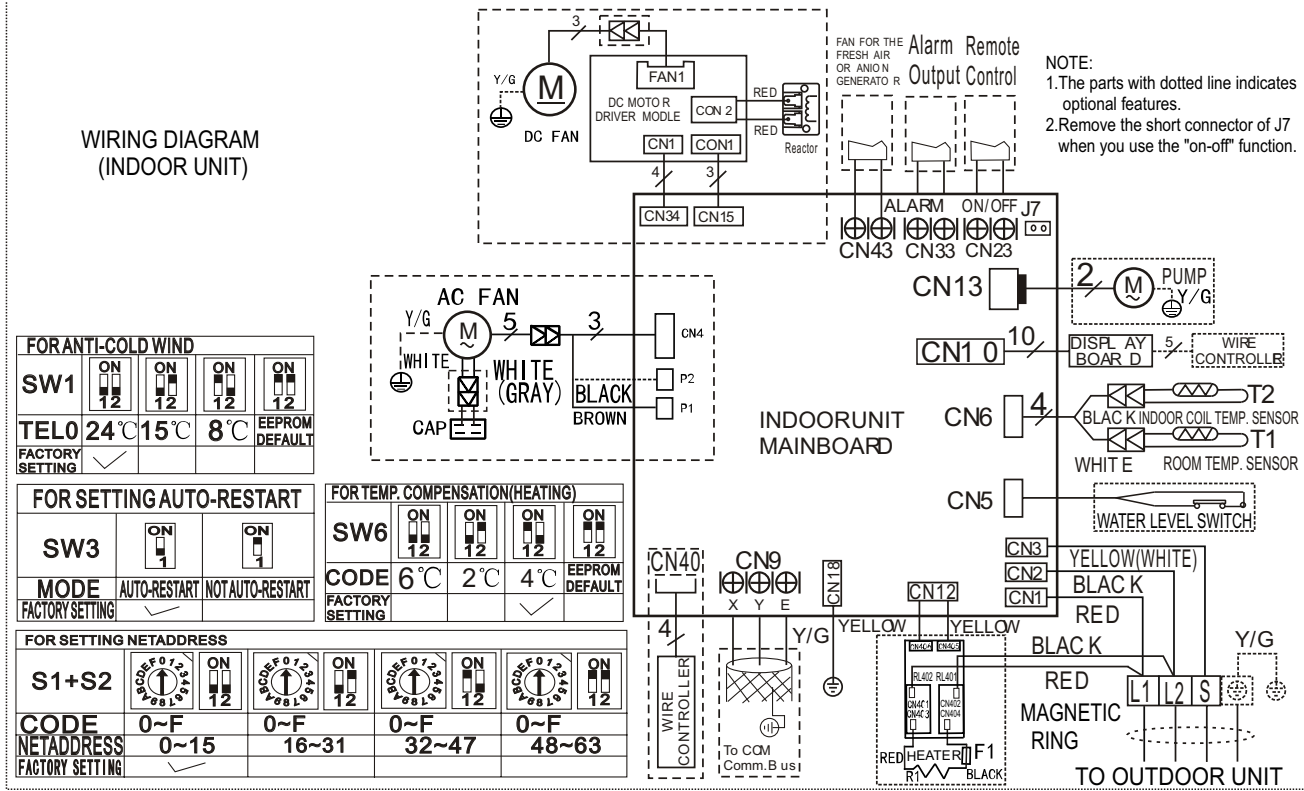

Fig. 21 —Size 58

A220763

WIRING DIAGRAMS



A220764

Fig. 22 —Wiring Diagram Sizes 9K - 24K

Indoor Unit	
Code	Part Name
CN1	Input: 230VAC High Voltage Connection of the terminal
CN2	Input: 230VAC High Voltage Connection of the terminal
CN3 / CN2b	Output: 0V Connection to the earth
CN5	Output: 0-5VDC Connection of the water level switch
CN6	Output: 5VDC Connection of the room and pipe temperature
CN8 / CN1a	Output: 320VDC High Voltage Connection of the reactor
CN7	Output: 5VDC Connection of the CCM
CN10 (CN10a)	Output: 12VDC Connection of the display board
CN12	Output: 220VAC High Voltage Connection of the electrical heater
CN13	Output: 220VAC High Voltage Connection of the pump
CN15	Output: 320VDC High Voltage Connection of the fan board
CN23	Output 1 - 12VDC Connection of the remote switch
CN33	Output: 0V Connection of the alarm
CN40	Output: 12VDC Connection of the wire controller
CN43	Output: 220VAC High Voltage Connection of the fresh air suction fan

WIRING DIAGRAMS (CONT)

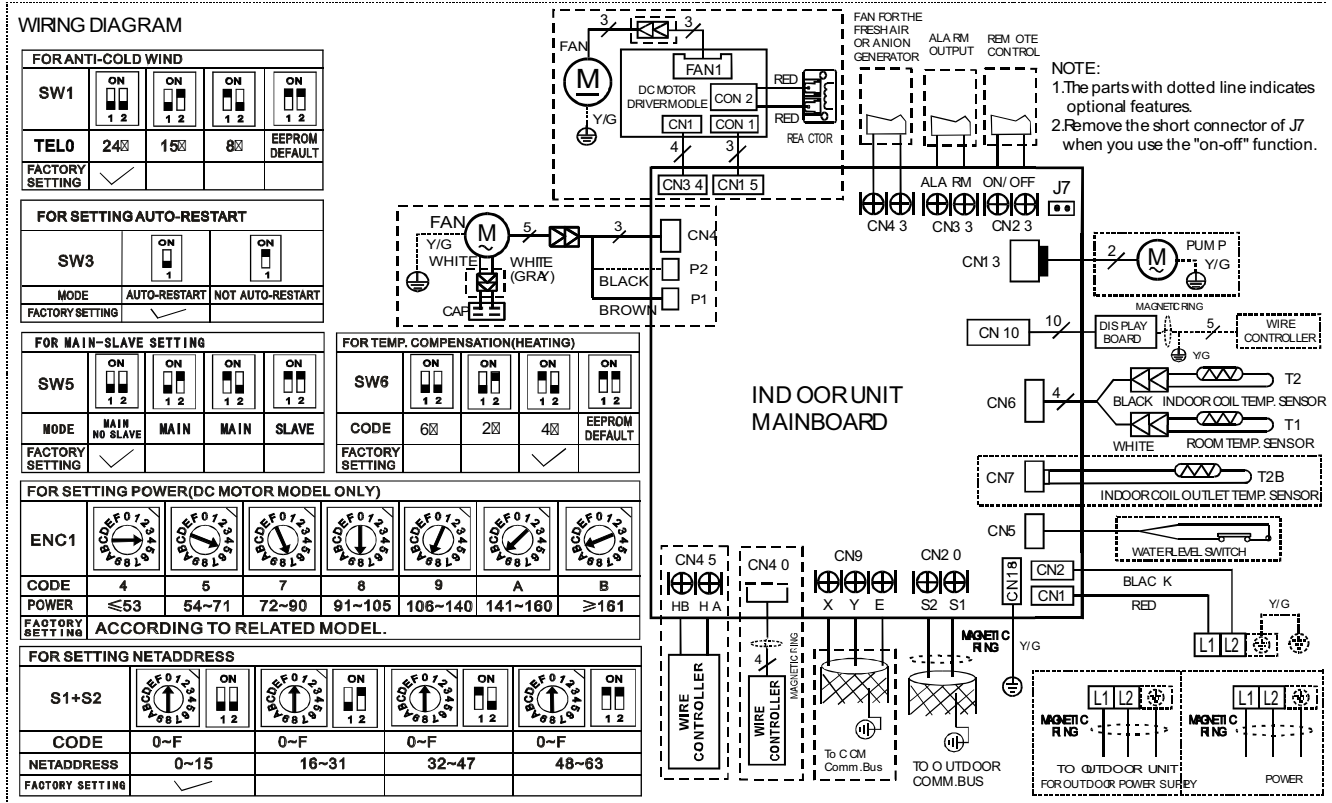

Fig. 23 —Wiring Diagram Sizes 36K - 48K

A220765

Indoor Unit	
Code	Part Name
CN1	Input: 230VAC High Voltage Connection of the terminal
CN2	Input: 230VAC High Voltage Connection of the terminal
CN5	Output: 0-5VDC Connection of the water level switch
CN6	Output: 5VDC Connection of the room and pipe temperature
CN8 / CN18	Output: 320VDC High Voltage Connection of the reactor
CN9	Output: 5VDC Connection of the CCM
CN10 (CN10A)	Output: 12VDC Connection of the display board
CN13	Output: 220VAC High Voltage Connection of the pump
CN15	Output: 320VDC High Voltage Connection of the fan board
CN23	Output 1 - 12VDC Connection of the remote switch
CN33	Output: 0V Connection of the alarm
CN40	Output: 12VDC Connection of the wire controller
CN43	Output: 220VAC High Voltage Connection of the fresh air suction fan

WIRING DIAGRAMS (CONT)

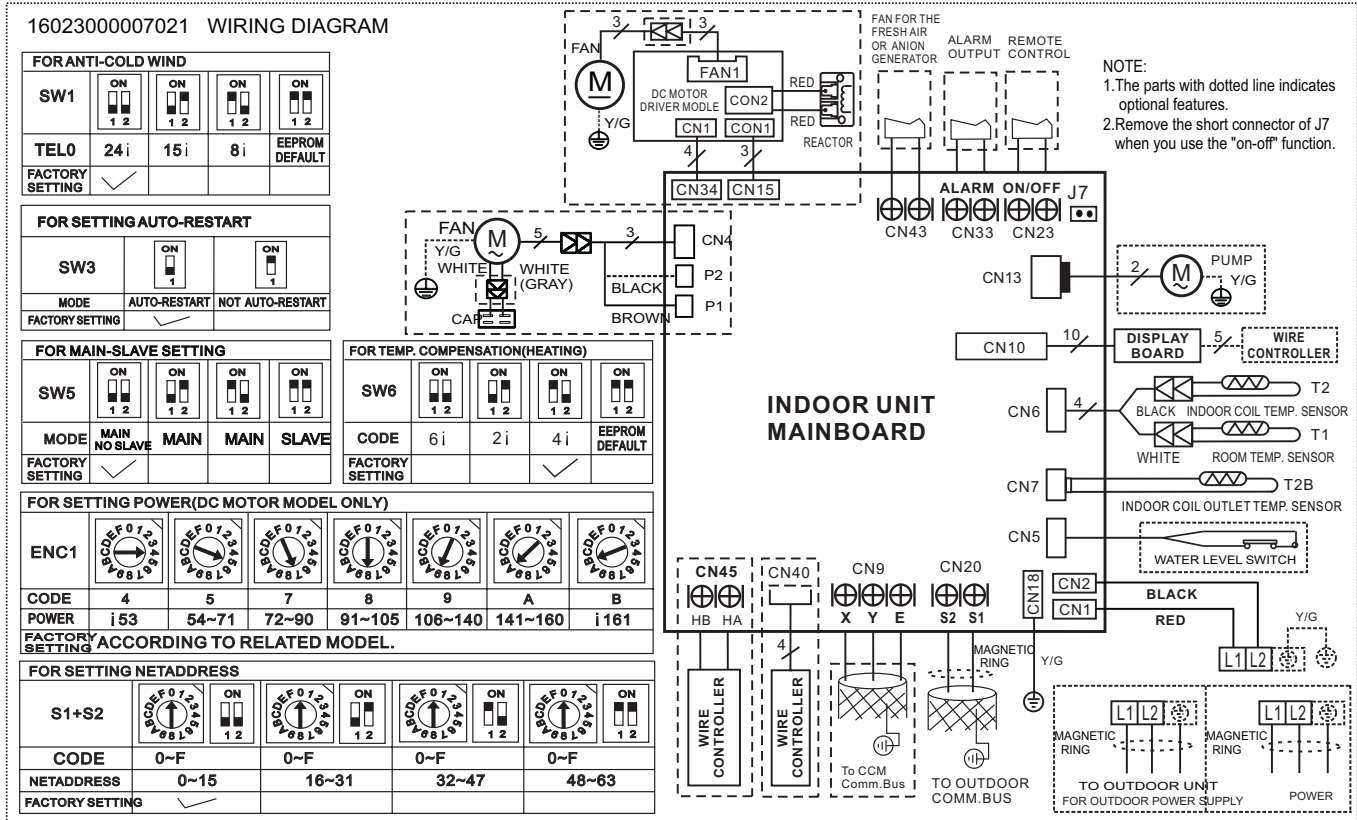

Fig. 24 —Wiring Diagram Size 58K

A220766

Indoor Unit	
Code	Part Name
CN1	Input: 230VAC High Voltage Connection of the terminal
CN2	Input: 230VAC High Voltage Connection of the terminal
CN3/CN2b	Output: 0V Connection of the earth
CN5	Output: 0-5VDC Connection of the water level switch
CN6	Output: 5VDC Connection of the room and pipe temperature
CN7	Output: 5VDC Connection of the indoor coil outlet temperature sensor T2B
CN8/CN1b	Output: 320VDC High Voltage Connection of the reactor
CN9	Output: 5VDC Connection of the CCM
CN10 (CN10A)	Output: 12VDC Connection of the display board
CN13	Output: 220VAC High Voltage Connection of the pump
CN15	Output: 320VDC High Voltage Connection of the fan board
CN23	Output 1 - 12VDC Connection of the remote switch
CN33	Output: 0V Connection of the alarm
CN20	Output: 24VDC between CN2 Connection of the S signal
CN41	Output: 24VDC between CN2 Connection of the S signal
CN43	Output: 220VAC High Voltage Connection of the fresh air suction fan

GUIDE SPECIFICATIONS

INDOOR DUCTED SLIM DUCTLESS UNITS

Size Range: 3/4 to 5 Ton Nominal Cooling and Heating Capacity Model
Number: **40MBDQ**

Part 1 - GENERAL

1.01 System Description

Indoor, slim ducted, direct-expansion fan coils are matched with a heat pump outdoor unit.

1.02 Agency Listings

Unit is rated per AHRI Standards 210/240 and listed in the AHRI directory as a matched system.

1.03 Delivery, Storage, And Handling

Units are stored and handled per the unit manufacturer's recommendations.

1.04 Warranty (For Inclusion By Specifying Engineer)

Part 2 - PRODUCTS

2.01 Equipment

A. General:

Indoor, direct-expansion, ceiling-mounted fan coil. The unit is complete with cooling/heating coil, fan, fan motor, piping connectors, electrical controls, microprocessor control system, and integral temperature sensing.

B. Unit Cabinet:

Unit cabinet is constructed of galvanized steel. The cabinet is fully insulated for improved thermal and acoustic performance.

C. Fans:

The fan is the tangential direct-drive blower type with air intake at the rear or bottom of the unit and discharge at the front.

D. Coil:

The coil is a copper tube with aluminum fins and galvanized steel tube sheets. The fins are bonded to the tubes by mechanical expansion and specially golden hydrophilic pre-coated for enhanced wet-ability. A drip pan under the coil has a factory installed condensate pump and drain connection for hose attachment to remove condensate.

E. Motors:

The motors have an open drip-proof, permanently lubricated ball bearing with inherent overload protection. Fan motors are 3-speed.

F. Controls:

The controls consist of a microprocessor-based control system which controls the space temperature, determines optimum fan speed, and runs self diagnostics. The temperature control range is 62°F to 86°F (17°C to 30°C) in increments of 1°F or 1°C, and has a 46°F **HEATING** mode (**HEATING** setback). The wireless remote controller can serve as the temperature sensing location for room comfort.

The unit has the following functions (at a minimum):

1. An automatic restart, after a power failure, which sets the unit back to the same operating conditions it operated under at time of failure.
2. A timer function to provide a minimum 24-hour timer cycle for system Auto Start/Stop.
3. Temperature-sensing controls sense return air temperature.
4. Indoor coil freeze protection.
5. Wireless infrared remote controller to enter set points and operating conditions.
6. **DEHUMIDIFICATION** mode provides increased latent removal capability by modulating system operation and set point temperature.
7. **FAN-ONLY** operation to provide room air circulation when cooling is not required.
8. Diagnostics provide continuous checks of unit operation and warns of possible malfunctions. Error messages appear on the unit.
9. The fan speed control is user-selectable: high, medium, low, or microprocessor controlled automatic operation during all operating modes.
10. Automatic heating-to-cooling changeover in the **HEAT** pump mode. The control includes deadband to prevent rapid mode cycling between heating and cooling.
11. Indoor coil high temperature protection is provided to detect an excessive indoor discharge temperature when the unit is in the **HEAT** pump mode.

G. Electrical Requirements:

The indoor fan motor operates on 208-230V. Power is supplied from the outdoor unit.

H. Operating Characteristics:

The 40MBDQ system has a minimum SEER (Seasonal Energy Efficiency Ratio) and HSPF at AHRI conditions, as listed on the specifications table.

I. Refrigerant Lines:

All units have refrigerant lines that can be oriented to connect from the side of the unit. Both refrigerant lines must be insulated.

