

# Owner's Manual

## TABLE OF CONTENTS

	PAGE
A NOTE ABOUT SAFETY .....	2
GENERAL .....	2
PARTS LIST .....	3
REMOTE CONTROL .....	4
FUNCTION BUTTONS .....	5
REMOTE CONTROL .....	7
SETTING THE TIMER .....	9
CLEANING, MAINTENANCE AND TROUBLESHOOTING .....	13
TROUBLESHOOTING .....	15

### NOTE TO EQUIPMENT OWNER:

Please read this Owner's Information Manual carefully before installing and using this appliance and keep this manual for future reference.

For your convenience, please record the model and serial numbers of your new equipment in the spaces provided. This information, along with the installation data and dealer contact information, will be helpful should your system require maintenance or service.

#### UNIT INFORMATION

Model # \_\_\_\_\_

Serial # \_\_\_\_\_

#### INSTALLATION INFORMATION

Date Installed \_\_\_\_\_

#### DEALERSHIP CONTACT INFORMATION

Company Name: \_\_\_\_\_

Address: \_\_\_\_\_

Phone Number: \_\_\_\_\_

Technician Name: \_\_\_\_\_

## A NOTE ABOUT SAFETY

Any time you see this symbol  in manuals, instructions and on the unit, be aware of the potential for personal injury. **There are 3 levels of precaution:**

1. **DANGER** identifies the most serious hazards which will result in severe personal injury or death.
2. **WARNING** signifies hazards that could result in personal injury or death.
3. **CAUTION** is used to identify unsafe practices which could result in minor personal injury or product and property damage.

**NOTE** is used to highlight suggestions which will result in enhanced installation, reliability, or operation.



### WARNING

#### **PERSONAL INJURY, DEATH AND / OR PROPERTY DAMAGE HAZARD**

Failure to follow this warning could result in personal injury, death or property damage.

Improper installation, adjustment, alteration, service, maintenance, or use can cause explosion, fire, electrical shock, or other conditions which may cause personal injury or property damage. Consult a qualified installer, service agency, or your distributor or branch for information or assistance. The qualified installer or service agency must use factory-authorized kits or accessories when modifying this product.

Read and follow all instructions and warnings, including labels shipped with or attached to unit before operating your new air conditioner.

## GENERAL

The ducted fan coil unit provides quiet, maximum comfort. In addition to cooling and/or heating, the ducted fan coil unit matched with an outdoor condensing unit filters and dehumidifies the air in the room to provide maximum comfort.

**IMPORTANT:** The ducted fan coil unit should be installed by authorized personnel only; using approved tubing and accessories.

If technical assistance, service or repair is needed, contact the installer. The ducted fan coil unit can be set up and operated from the remote control (provided). If the remote is misplaced, the system can be operated from the “Auto” setting on the unit.

### Operating Modes

The ducted fan coil unit has five operating modes:

- **FAN Only**
- **AUTO**
- **HEATING (heat pumps only)**
- **COOLING**
- **DEHUMIDIFICATION (DRY)**

#### FAN Only

In the **FAN Only** mode, the system filters and circulates the room air without changing room air temperature.

#### AUTO

In the **AUTO** mode, the system automatically cools or heats the room according to the user-selected set point.

**NOTE:** **AUTO** mode is recommended for use on single zone applications **ONLY**. Using **AUTO CHANGEOVER** on multi-zone applications could set an indoor unit to **STANDBY** mode, indicated with two dashes (--) on the display, which will turn off the indoor unit until all the indoor units are in the same mode (**COOLING** or **HEATING**). **HEATING** is the system's priority mode. Simultaneous **HEATING** and **COOLING** is not allowed.

#### HEATING

In the **HEATING** mode, the system heats and filters the room air.

#### COOLING

In the **COOLING** mode, the system cools, dries and filters the room air.

#### DEHUMIDIFICATION (DRY)

In **DEHUMIDIFICATION** mode, the system dries, filters and slightly cools the room air temperature. This mode prioritizes air dehumidification but it **does not** take the place of a dehumidifier.

### Wireless Remote Control

The remote control transmits commands to set up and operate the system. The control has a window display panel that displays the current system status. The control can be secured to a surface when used with the mounting bracket provided.

### Wired Remote Control (Optional)

Refer to the Wired Controller manual.

### 24V Interface (Optional)

Allows the control of the Ductless System with a third party thermostat.

# PARTS LIST

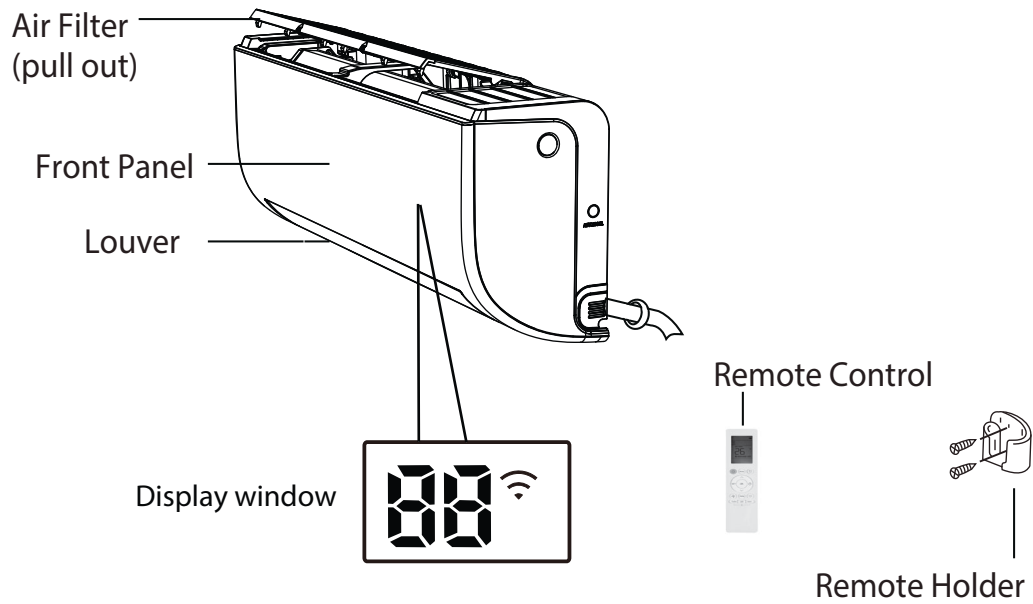

Fig. 1 — Indoor Unit

## INDOOR UNIT DISPLAY INDICATOR

- " **ON** " for 3 seconds when:
  - TIMER ON is set
  - SWING, TURBO, or SILENCE features are turned on
- " **OF** " for 3 seconds when:
  - TIMER OFF is set
  - SWING, TURBO, or SILENCE features are turned off
- " **cF** " when anti-cold air feature is turned on (Heat Pump units)
- " **dF** " when defrosting (Heat Pump units)
- " **SC** " when unit is self-cleaning
- " **FP** " when freeze protection is turned on

The unit displays the set point temperature.  
In Fan mode, the unit displays the room temperature.

Fig. 2 — Display Panel

# REMOTE CONTROL



Fig. 3 — Remote Control

# FUNCTION BUTTONS

Before you begin using your new air conditioner, make sure to familiarize yourself with the remote control. The following is a brief introduction to the remote control.

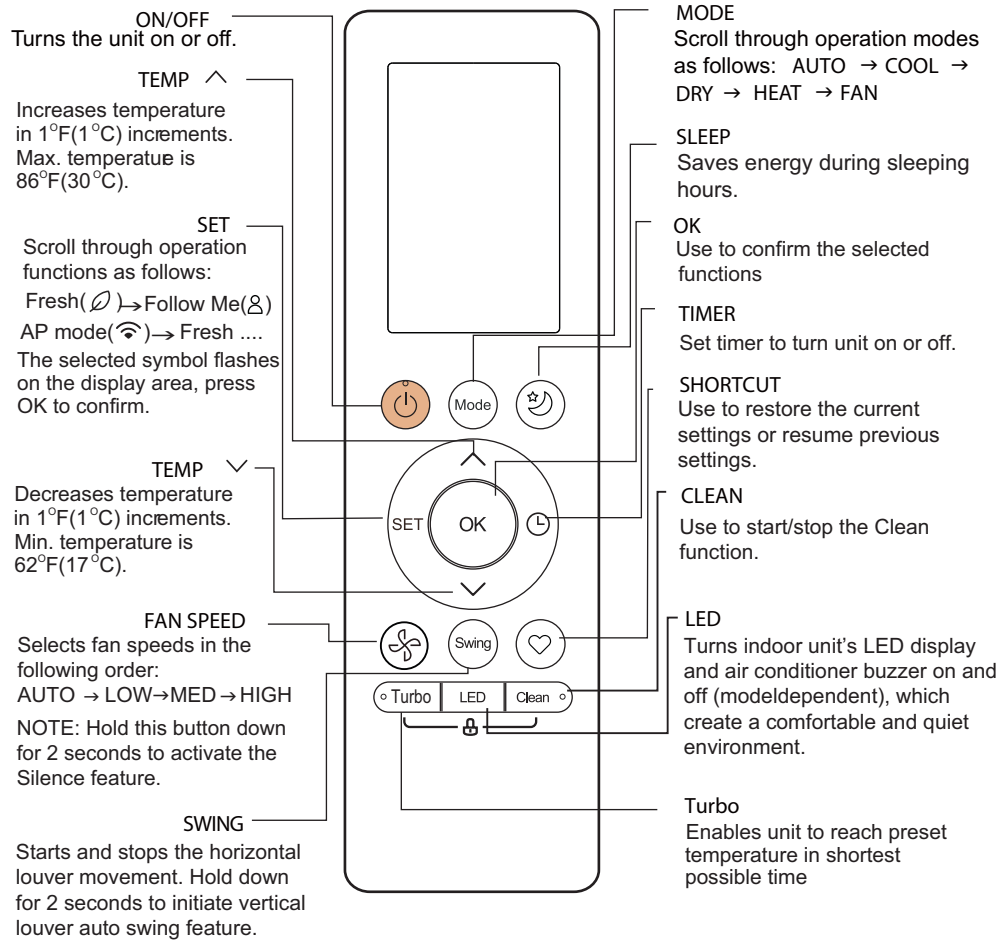

**Fig. 4 — Remote Controller**

**NOTE:** New remote controller starting production of week 05 year 2021 (serial number 0521V10001). For advanced functions, refer to the RG10B(B1)/BGEFU1 Wireless Remote Controller's Service Manual.

# Remote LCD Screen Indicators

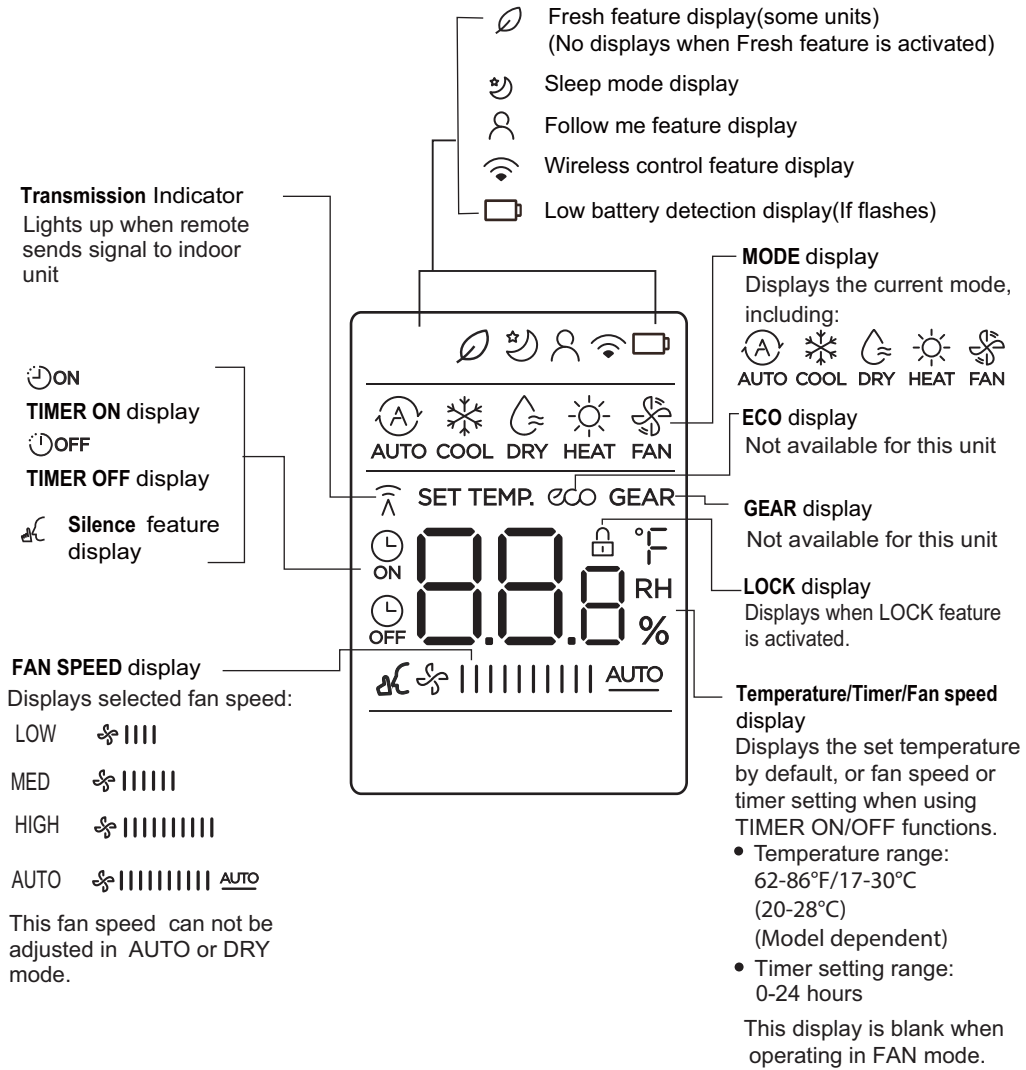

**Fig. 5 — Unit Display**

# REMOTE CONTROL



## CAUTION

### EQUIPMENT DAMAGE HAZARD

Failure to follow this caution may result in equipment damage. Handle the control with care and avoid getting the control wet.

**IMPORTANT:** The wireless remote control can operate the unit from a distance of up to 26 ft. (8 m) as long as there are no obstructions.

When the timer function is used, the remote control should be kept in the vicinity of the unit (within 26 ft. (8 m)).

The remote control can perform the following basic functions:

- Turn the system **ON** and **OFF**
- Select the operating mode
- Adjust room air temperature set point and fan speed
- Adjust the airflow direction.

Refer to the “FUNCTION BUTTONS” on page 5 for a detailed description of all the capabilities of the remote control.

### Battery Installation

Two AAA 1.5v alkaline batteries (included) are required to operate the remote control.

### To install or replace batteries:

1. Slide the back cover off the control to open the battery compartment.
2. Insert the batteries. Follow the polarity markings inside the battery compartment.
3. Replace the battery compartment cover.

### NOTES:

1. When replacing batteries, do not use old batteries or a different type of battery. This may cause the remote control to malfunction.
2. If the remote is not going to be used for several weeks, remove the batteries. Otherwise, battery leakage may damage the remote control.
3. The average battery life under normal use is about 6 months.
4. Replace the batteries when there is no audible beep from the indoor unit or if the Transmission Indicator fails to light.
5. When batteries are removed, the remote control erases all programmed settings. The control must be reprogrammed after the insertion of new batteries.

## Remote Control Operation - Quick Start

Before operation, ensure the unit is plugged in and the power is available.

### AUTO Mode

In **AUTO** mode, the unit automatically selects the **COOL**, **FAN**, or **HEAT** operation based on the set temperature.

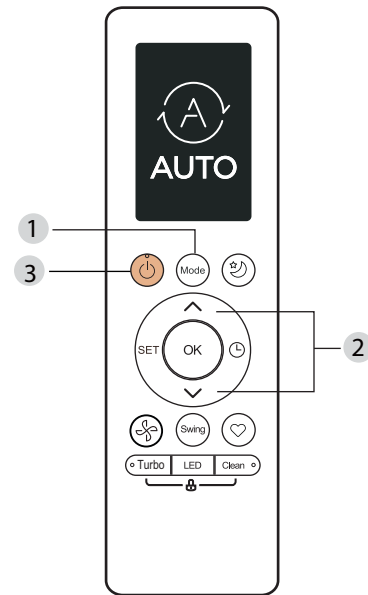

Fig. 6 — AUTO Mode

1. Press **MODE** to select **AUTO**.
2. Set your desired temperature using **TEMP A** or **TEMP V**.
3. Press **ON/OFF** to start the unit.

**NOTE:** Fan speed can not be set in the **AUTO** mode.

### COOL Mode

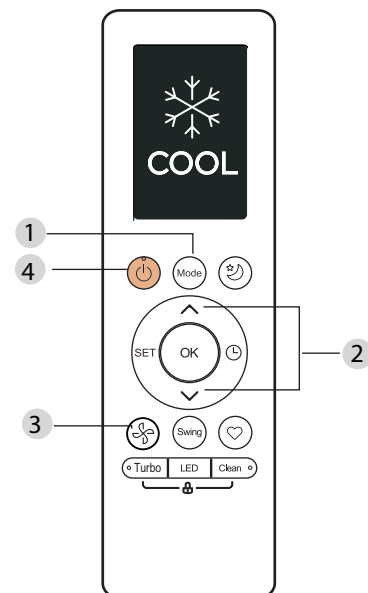
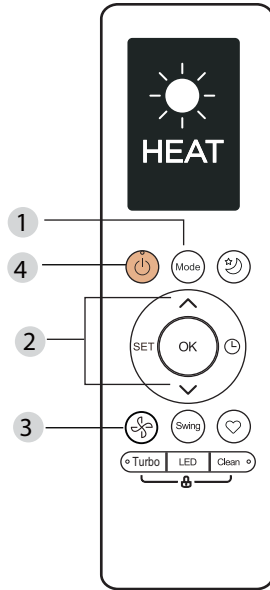

Fig. 7 — COOL Mode

1. Press **MODE** to select the **COOL** mode.
2. Set your desired temperature using **TEMP A** or **TEMP V**.
3. Press **FAN** to select the fan speed in a range of AU\*100%,
4. Press **ON/OFF** to start the unit.

## HEAT Mode

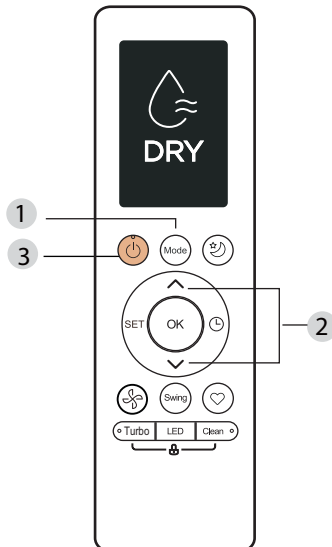

**Fig. 8 — HEAT Mode**

1. Press **MODE** to select the **HEAT** mode.
2. Set your desired temperature using **TEMP ▲** or **TEMP ▼**.
3. Press **FAN** to select the fan speed in the range of AU-100%.

**NOTE:** As the outdoor temperature drops, the performance of your unit's **HEAT** function may be affected. In such instances, we recommend using this air conditioner in conjunction with other heating.

## DRY Mode



**Fig. 9 — DRY Mode**

1. Press **MODE** to select the **DRY** mode.
2. Set your desired temperature using **TEMP ▲** or **TEMP ▼**.
3. Press **ON/OFF** to start the unit.

## FAN Mode

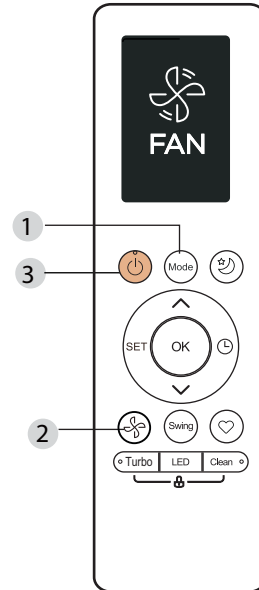

**Fig. 10 — FAN Mode**

1. Press **MODE** to select the **FAN** mode.
2. Press **FAN** to select the fan speed in the range of AU-100%.
3. Press **ON/OFF** to start the unit.



# SETTING THE TIMER

## TIMER ON/OFF

### TIMER ON

Press **TIMER** to initiate the **ON** time sequence.



Press **Temp. UP or DOWN** multiple times to set the desired time to turn on the unit.



Point remote towards the unit and wait 1 second. **TIMER ON** will be activated.



### TIMER OFF setting

Press **TIMER** to initiate the **OFF** time sequence.



Press **Temp. up or down** multiple times to set the desired time to turn off the unit.



Point remote towards the unit and wait 1 second. **TIMER OFF** will be activated.



Fig. 11 — Setting the **TIMER ON** Setting

### NOTE:

1. When setting the **TIMER ON** or **TIMER OFF**, the time increases by 30 minutes increments with each press, up to 10 hours. After 10 hours and up to 24, it increases in 1 hour increments. (For example, press 5 times to get 2.5h, and press 10 times to get 5h,) The timer reverts to 0.0 after 24.
2. Cancel either function by setting its timer to 0.0h.

### TIMER ON and OFF

#### TIMER ON & OFF setting

Keep in mind that the time periods you set for both functions refer to hours after the current time.

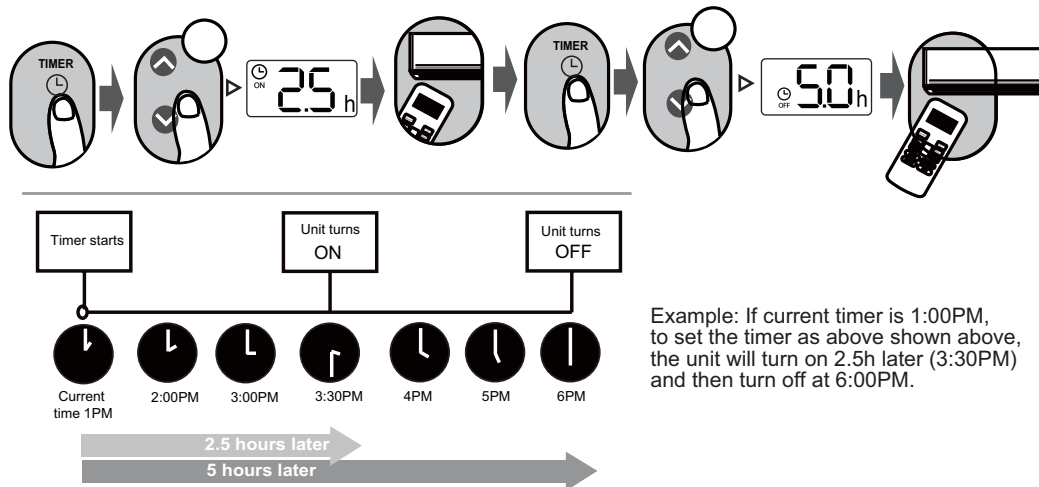
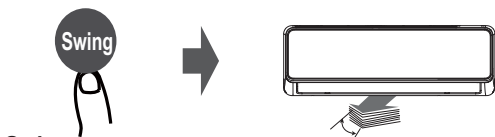

Fig. 12 — Timer ON and OFF

### Swing Function

Press **Swing**



**Swing**  
The horizontal louver swings up and down automatically when pressing **Swing**. Press **Swing** again to make it stop.

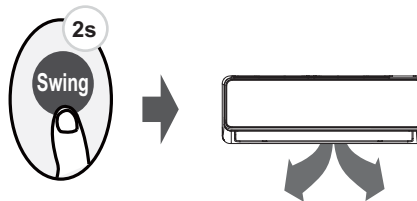

Keep pressing **Swing** more than 2 seconds, the vertical louver swing function activates. (model dependent)

### Shortcut Function

Press **Shortcut**

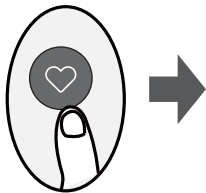

Push **Shortcut** when the remote controller is on, the system automatically reverts back to the previous settings including the operating mode, setting temperature, fan speed level and sleep feature (if activated).

If pushing more than 2 seconds, the system automatically restores the current operation settings including operating mode, setting temperature, fan speed level and sleep feature (if activated).

### Turbo Function

Press **Turbo**

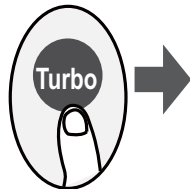

When you select **Turbo** in **COOL** mode, the unit blows cool air with the strongest wind setting to jump-start the cooling process.

When you select the **Turbo** feature in **HEAT** mode, for units with Electric Heat elements, the Electric Heater activates and jump-start the heating process.

### Clean Function

Press **Clean**

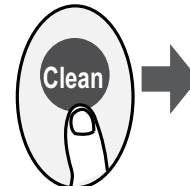

Airborne bacteria can grow in the moisture that condenses around the heat exchanger in the unit. With regular use, most of this moisture is evaporated from the unit.

By pressing **Clean** button, the unit cleans itself automatically. After cleaning, the unit turns off automatically. Pressing **Clean** mid-cycle cancels the operation and turn off the unit. You can use **Clean** as often as you like.

**Note:** You can only activate this function in the **COOL** or **DRY** mode.

**LED DISPLAY**

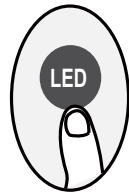

Press LED

Press **LED** to turn on and turn off the display on the indoor unit.

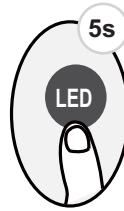

Press **LED** more than 5 seconds (some units)

Keep pressing **LED** more than 5 seconds, the indoor unit displays the actual room temperature. Press more than 5 seconds again to revert back which displays the setting temperature.

**LOCK Function**

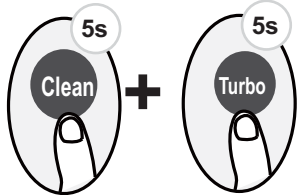

Press **Clean** and **Turbo** at the same time more than 5 seconds to activate **Lock** function. All buttons will not respond except when pressing these two buttons for two seconds again to disable locking.

**SILENCE Function**



Keep pressing **Fan** for more than 2 seconds to activate/disable the **Silence** function (some units). Due to the low frequency operation of the compressor, it may result in insufficient cooling and heating capacity. Press **ON/OFF, Mode, Sleep, Turbo** or **Clean** while operating to cancel the **Silence** function.

**FP Function**

Press 2 times during one second under the **HEAT** Mode and setting temperature of 62°F/17°C or 20°C (for model of RG10B10(B)/BGEF).



The unit operates at a high fan speed (while the compressor is on) with the temperature automatically set to 46°C/8°F.

**Note:** This function is for the heat pump air conditioner **only**. Press this button 2 times during one second under the **HEAT** Mode and setting temperature of 62°F/17°C or 20°C (for model RG10B10(B)/BGEF) to activate the **FP** function. Press **On/Off, Sleep, Mode, Fan** and **Temperature** while operating, cancels this function.

### SLEEP Function

Press SLEEP



The **SLEEP** function is used to decrease energy while occupants sleep (and do not require the same temperature settings for comfort). This function can only be activated via the remote control.

For the details, please see "Sleep Operation" in "USER'S MANUAL".

**Note:** The SLEEP function is not available in FAN or DRY mode.

### SET Function

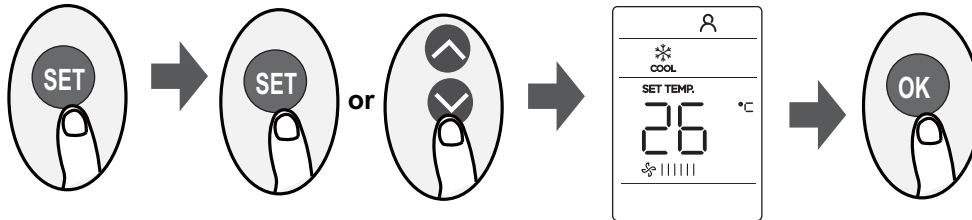

- Press **SET** to enter the function setting, then press **SET** or **TEMP** ↓ or **TEMP** ↑ to select the desired function. The selected symbol flashes on the display area, press **OK** to confirm.
- To cancel the selected function, just perform the same procedures as above.
- Press **SET** to scroll through operation functions as follows:  
 Fresh\* (∅) → Follow Me (⋈) → AP mode (📶)  
 [\*]: If your remote controller has the **Fresh** function, you can not use the **SET** button to select the **Fresh** function.

#### **FRESH** Function (∅) (some units) :

When the **FRESH** function is initiated, the Ionizer/Plasma Dust Collector (depending on models) is energized and helps to remove pollen and impurities from the air.

#### **Follow me** function (⋈) :

The **FOLLOW ME** function enables the remote control to measure the temperature at its current location and sends this signal to the air conditioner under a every 3 minutes interval. When using **AUTO**, **COOL** or **HEAT** modes, measuring ambient temperature from the remote control (instead of from the indoor unit itself) will enables the air conditioner to optimize the temperature around you and ensure maximum comfort.

**NOTE:** Press and hold **Turbo** for seven seconds to start/stop the **Memory** feature of the **FOLLOW ME** function

- If the memory feature is activated, "ON" displays for 3 seconds on the screen.
- If the memory feature is stopped, "OF" displays for 3 seconds on the screen.
- While the memory feature is activated, press the **ON/OFF**, shift the mode or power failure will not the **FOLLOW ME** function.

#### **AP Mode** (📶) (some units) :

Choose **AP mode** to perform wireless network configuration. For some units, it does not work by pressing the **SET** button. To enter the **AP mode**, continuously press the **LED** seven times in 10 seconds.

# CLEANING, MAINTENANCE AND TROUBLESHOOTING

**⚠ CAUTION**

**ELECTRICAL SHOCK HAZARD**

Failure to follow this caution may result in personal injury or death. Always turn off power to the system before performing any cleaning or maintenance to the system. Turn off the outdoor disconnect switch located near outdoor unit. Be sure to disconnect the indoor unit if on a separate switch.

**⚠ CAUTION**

**EQUIPMENT DAMAGE/OPERATION HAZARD**

Failure to follow this caution may result in equipment damage or improper unit operation.

Operating the system with dirty air filters may damage the indoor unit and could cause reduced cooling performance, intermittent system operation, frost build-up on indoor coil or blown fuses.

## Periodic Maintenance

Periodic maintenance is recommended to ensure proper operation of the unit. Recommended maintenance intervals may vary depending on the installation environment, e.g., dusty zones, etc. Refer to Table 2 on page 15.

**⚠ CAUTION**

**CUT HAZARD**

Failure to follow this caution may result in personal injury. The coil fins are very sharp. Use caution when cleaning.

Always wear safety protection.

## Cleaning the Coil

Clean the coil at the beginning of each cooling season, or when necessary. Use a vacuum cleaner or a long-bristle brush to avoid damage to the coil fins.

## Cleaning the Air Filters

Remove and clean the air filters once a month. A clogged air conditioner can reduce the cooling efficiency of your unit, and can also be bad for your health.

**NOTE:** If air filters show signs of excessive wear or are torn, they must be replaced. Contact your local dealer for replacement filters.

1. The air filter is under the top air inlet grill.
2. Grip the tab on the end of the filter, lift it up, then pull it towards yourself.
3. If your filter has a small air freshening filter, un-clip it from the larger filter. Clean the air freshening filter with a hand-held vacuum.
4. Clean the large air filter with warm, soapy water. Be sure to use a mild detergent.
5. Rinse the filter with fresh water, then shake off any excess water.
6. Dry it in a cool, dry place, and refrain from exposing it to direct sunlight.
7. When dry, re-clip the air freshening filter to the larger filter, then slide it back into the indoor unit.

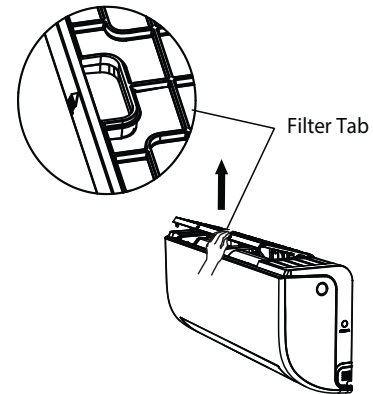

Fig. 13 — Filter Tab

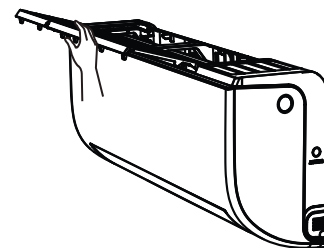

Fig. 14 — Filter Tab



Fig. 15 — Rinse the Filter

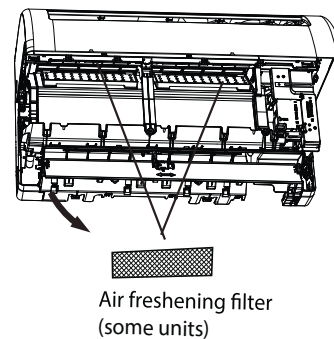

Fig. 16 — Air Freshening Filter

**⚠ CAUTION**

**EQUIPMENT DAMAGE HAZARD**

Failure to follow this caution may result in equipment damage. When cleaning the front panel, do not use water hotter than 105°F (40.6°C) and do not pour water onto the fan coil.

Do not use abrasive or petroleum based cleaners as they may damage the front panel.

## Indoor Unit Front Panel

To clean the front panel on the indoor unit, wipe the outside with a soft, dry cloth.

## Preparing for Extended Shutdown Period

Clean the filters and reposition them in the unit. Operate the unit in **FAN ONLY** mode for 12 hours to dry all internal parts. Turn the main power supply off and remove batteries from the remote control.

## System Operation Recommendations

The items outlined in the following list help to assure proper system operation:

- Replace both remote control batteries at the same time.
- Point the remote control toward the unit display panel when transmitting a command.
- Keep doors and windows closed while unit is operating.
- Contact an authorized service representative if a problem arises that cannot be easily resolved.
- Do not perform cleaning or maintenance activities while the unit is on.
- Keep the display panel on the unit away from direct sunlight and heat as this may interfere with remote control transmissions.
- Do not block air intakes and outlets on the indoor or outdoor units.

## Energy Saving Recommendations

The following recommendations will add greater efficiency to the ductless system:

- Select a comfortable thermostat setting and leave it at chosen setting. Avoid continually raising and lowering the setting.
- Keep the filter clean. Frequent cleaning may be necessary depending on indoor air quality.
- Use drapes, curtains or shades to keep direct sunlight from heating the room on very hot days.
- Limit the unit's run time by using the **TIMER** function.
- Do not obstruct the air intake on the front panel.
- Turn on the air conditioning unit before the indoor air becomes too uncomfortable.

# TROUBLESHOOTING

Refer to Table 3 on page 16 before contacting your local dealer.

**Table 1 — Periodic Maintenance**

INDOOR UNIT	EVERY MONTH	EVERY 6 MONTHS	EVERY YEAR
Clean Air Filter*	•		•
Replace Carbon Filter		•	
Change Remote Control Batteries			•
OUTDOOR UNIT	EVERY MONTH	EVERY 6 MONTHS	EVERY YEAR
Clean Outdoor Coil from Outside		•	
Clean Outdoor Coil from Inside†			•
Blow Air Over Electric Parts†			•
Check Electric Connection Tightening†			•
Clean Fan Wheel†			•
Check Fan Tightening†			•
Clean Drain Pans†			•

\* Increase frequency in dusty zones.

† Maintenance to be carried out by qualified service personnel. Refer to the Installation Manual.

## Common Problems

**Table 2 — Common Problems**

Problem	Possible Causes
Unit does not turn on when pressing <b>ON/ OFF</b>	The unit has a 3-minute protection feature that prevents the unit from overloading. The unit cannot be restarted within three minutes of being turned off.
The unit changes from <b>COOL/HEAT</b> mode to <b>FAN</b> mode	The unit may change its setting to prevent frost from forming on the unit. Once the temperature increases, the unit starts operating in the previously selected mode again. The set temperature has been reached, at which point the unit turns off the compressor. The unit continues operating when the temperature fluctuates again.
The indoor unit emits white mist	In humid regions, a large temperature difference between the room's air and the conditioned air can cause white mist.
Both the indoor and outdoor units emit white mist	When the unit restarts in the <b>HEAT</b> mode after defrosting, white mist may be emitted due to moisture generated from the defrosting process.
The indoor unit makes noises	A rushing air sound may occur when the louver resets its position. A squeaking sound may occur after running the unit in <b>HEAT</b> mode due to expansion and contraction of the unit's plastic parts.
Both the indoor unit make noises	Low hissing sound during operation: This is normal and is caused by refrigerant gas flowing through both indoor and outdoor units. Low hissing sound when the system starts, has just stopped running, or is defrosting: This noise is normal and is caused by the refrigerant gas stopping or changing direction. Squeaking sound: Normal expansion and contraction of plastic and metal parts caused by temperature changes during operation can cause squeaking noises.
The outdoor unit makes noises	The unit will make different sounds based on its current operating mode.
Dust is emitted from either the indoor or outdoor unit	The unit may accumulate dust during extended periods of non-use, which will be emitted when the unit is turned on. This can be mitigated by covering the unit during long periods of inactivity.
The unit emits a bad odor	The unit may absorb odors from the environment (such as furniture, cooking, cigarettes, etc.) which will be emitted during operations. The unit's filters have become moldy and should be cleaned.
The fan of the outdoor unit does not operate	During operation, the fan speed is controlled to optimize product operation.
Operation is erratic, unpredictable, or unit is unresponsive	Interference from cell phone towers and remote boosters may cause the unit to malfunction. In this case, try the following: <ul style="list-style-type: none"> <li>• Disconnect the power, then reconnect.</li> <li>• Press ON/OFF button on remote control to restart operation.</li> </ul>

**NOTE:** If an issue persists, contact a local dealer or your nearest customer service center. Provide them with a detailed description of the unit malfunction as well as your model number.

**Table 3 — Troubleshooting**

<b>PROBLEM</b>	<b>POSSIBLE CAUSE</b>	<b>SOLUTION</b>
Unit/System Does Not Work	The circuit breaker has tripped or a fuse has blown.	Reset the circuit breaker or replace the fuse with the specified replacement fuse.
	Power failure	Restart the operation when the power is restored.
	Diagnostic lights illuminate.*	Call your service representative
	Voltage is too low.	Call your service representative.
Poor cooling performance	The filter is blocked by dust.	Clean the air filter
	Temperature is not set properly.	Check the temperature and reset if necessary.
	A window or door is open.	Close the window or door.
	The outdoor unit is obstructed.	Turn the unit off, remove the obstruction and turn it back on.
	The fan speed is too low.	Change the fan speed selection.
	The operation mode is in Fan instead of Cool.	Change the operating mode to Cool or reset the unit.
Poor heating performance	The filter is blocked with dust.	Clean the filter.
	The temperature is set too low.	Check the temperature and reset if necessary.
	A window or door is open	Ensure all the doors and windows are closed while operating the unit.
	The outdoor unit is obstructed.	Turn the unit off, remove the obstruction and turn the unit back on.
Unit stops during operation	The OFF timer is not operating correctly.	Restart the operating mode.
	Diagnostic lights illuminate	Call a service representative for service

\* Diagnostic lights are a combination of lights that will illuminate in the display area on the unit. They are a combination of the lights you see during normal operation.