

Premier 90

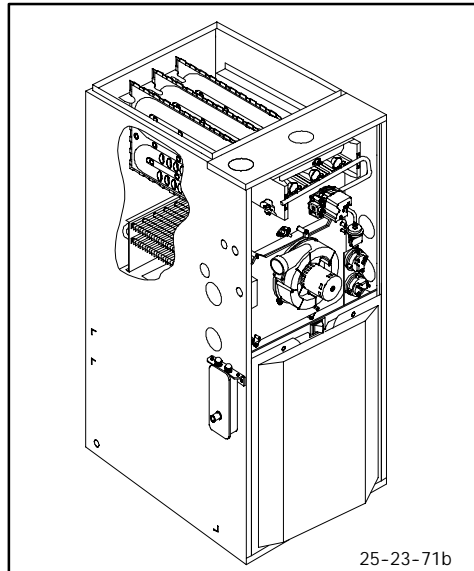

Representative drawing only, some models may vary in appearance.

WARNING

This furnace is not designed for use inside mobile homes, trailers, or recreational vehicles. Such use could result in property damage, bodily injury, and/or death.

Dealer/Contractor

Flexibility

- Dual Certified venting (1 or 2 pipe). Direct Vent furnace
- 40" high with wider cabinets, for noise reduction and ease of installation.
- Factory shipped as natural gas, with LP Gas conversion kits available.
- Four position - upflow/downflow/horizontal installation.
- Vent pipe can be run horizontally or vertically.

Service

- Self diagnostics.
- Entire blower assembly mounted on rails.

Homeowner

Quality

- RPJ III Stainless steel heat exchanger.
- Stainless steel secondary heat exchanger.
- Lifetime limited warranty on heat exchangers and 5 years on parts.
- High temperature limit control prevents overheating.
- Hot surface pilot ignition device.
- Flame roll-out sensors standard.
- External filter rack with permanent filters.
- Solid doors.

Comfort

- Adjustable timed blower Off delay.
- Thermal lined, one piece steel cabinet for noise reduction.
- Insulated blower compartment.
- Humidifier terminal
- Electronic air cleaner terminal.

Efficiency

- 92.1% AFUE efficiency range.
- Two stage gas valve operation.
- Two stage fan timer.
- Multispeed, prelubricated PSC blower motors.
- Induced draft blower.
- In-shot burners.

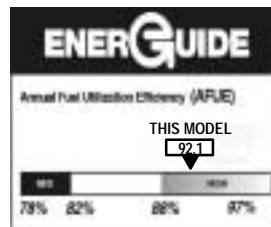

FURNACE SPECIFICATIONS

Model Number	*9MPT050F12	*9MPT075F14	*9MPT100J16	*9MPT125L20
INPUT HIGH FIRE (BTUH) LOW FIRE (BTUH)	50,000 35,000	75,000 53,000	100,000 70,000	125,000 87,500
HTG. CAP. HIGH FIRE (BTUH) LOW FIRE (BTUH)	46,000 32,200	69,000 48,800	92,000 64,400	114,000 80,500
AFUE % (ICS)	92.1	92.1	92.1	92.1
CSE %	84.9	85.1	85.5	85.2
TEMP. RISE RANGE High Fire (°F) Low Fire (°F)	35-65 25-55	40-70 30-60	40-70 30-60	40-70 30-60
VENT SIZE ^	2" - 3" OD	2" - 3" OD	3" OD	3" OD
VOLTS/PH/HZ	115/60/1	115/60/1	115/60/1	115/60/1
MIN./MAX. VOLTAGE	97/132	97/132	97/132	97/132
F.L.A.	9.8	8.9	9.0	11.2
TRANSFORMER (V.A.)	40	40	40	40
GAS PIPE SIZE (IN.)	1/2	1/2	1/2	1/2
COOLING CAP. (TONS)	3.0	3.5	4.0	5.0
FILTER SIZE (IN.)	16X25X1(1)	16X25X1(1)	16X25X1(1)	16X25X1(2)
HIGH ALTITUDE PRESSURE SWITCH	1013165	1013165	1013165	1013157
DIMENSIONS (in.) WIDTH X DEPTH X HEIGHT	19 ¹ / ₈ x 29 x 40	19 ¹ / ₈ x 29 x 40	22 ³ / ₄ x 29 x 40	24 ¹ / ₂ x 29 x 40
WEIGHT (Lbs.)	150	158	182	203

^ Vent size may vary depending on length, number of elbows, standard vent or direct vent.
See Installation Instructions.

BLOWER PERFORMANCE

Model Number	*9MPT050F12	*9MPT075F14	*9MPT100J16	*9MPT125L20
BLOWER TYPE AND SIZE	11-8	11-8	11-10	11 - 10
MOTOR H.P. (TYPE)	1/2 PSC	1/2 PSC	1/2 PSC	3/4 PSC
MOTOR SPEEDS	4	4	4	4

AIRFLOW DATA

.10 ESP IN. W.C.	LOW	826	695	823	1720
	MEDIUM LOW	1083	1025	1109	1910
	MEDIUM HIGH	1301	1455	1527	2127
	HIGH	1408	1724	1850	2315
.20 ESP IN. W.C.	LOW	804	674	795	1686
	MEDIUM LOW	1050	1001	1087	1881
	MEDIUM HIGH	1242	1410	1482	2087
	HIGH	1347	1662	1791	2268
.30 ESP IN. W.C.	LOW	770	653	747	1644
	MEDIUM LOW	1028	951	1056	1833
	MEDIUM HIGH	1195	1366	1426	2024
	HIGH	1295	1601	1720	2201
.40 ESP IN. W.C.	LOW	735	631	677	1600
	MEDIUM LOW	985	921	1016	1777
	MEDIUM HIGH	1153	1309	1382	1961
	HIGH	1237	1530	1648	2131
.50 ESP IN. W.C.	LOW	698	609	617	1533
	MEDIUM LOW	952	891	970	1720
	MEDIUM HIGH	1093	1252	1317	1891
	HIGH	1183	1460	1575	2029
.60 ESP IN. W.C.	LOW	657	569	544	1494
	MEDIUM LOW	909	845	854	1647
	MEDIUM HIGH	1040	1187	1245	1804
	HIGH	1118	1380	1485	1948
.70 ESP IN. W.C.	LOW	---	529	---	1413
	MEDIUM LOW	863	799	763	1571
	MEDIUM HIGH	935	1122	1154	1708
	HIGH	1053	1300	1401	1820

* Denotes Brand (T, H or C)

MODEL NUMBER IDENTIFICATION GUIDE

Brand Identifier * = Brand	9	MP	T	075	F	12	A	#
Model Identifier 8 = Non-Condensing, 80+% Gas Furnace 9 = Condensing, 90+% Gas Furnace								
Installation Configuration UP = Upflow DN = Downflow UH = Upflow/Horizontal HZ = Horizontal DH = Downflow/Horizontal MP = Multiposition, Up/Down/Horizontal								
Major Design Feature 1 = One (Single) Pipe N = Single Stage 2 = Two Pipe P = PVC Vent D = 1 or 2 Pipe T = Two Stage L = Low NOX V = Variable Speed								
								Engineering Rev. Denotes minor changes
								Marketing Digit Denotes minor change
								Cooling Airflow 08 = 800 CFM 12 = 1200 CFM 14 = 1400 CFM 16 = 1600 CFM 20 = 2000 CFM
								Cabinet Width B = 15.5" Wide F = 19.1" Wide J = 22.8" Wide L = 24.5" Wide
								Input (Nominal MBTUH)

DIMENSIONS

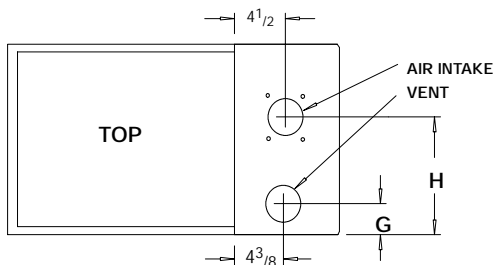

TOP	BOT.	RH	LH	BACK	FRNT	FLUE
1"	0"	0"	0"	0"	3"	0"

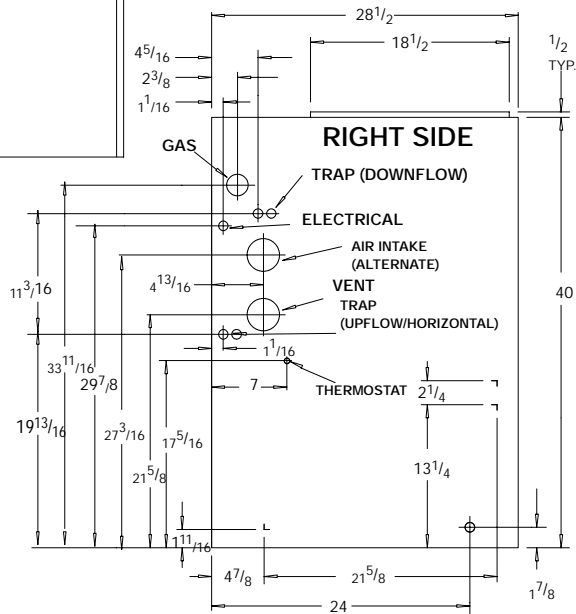
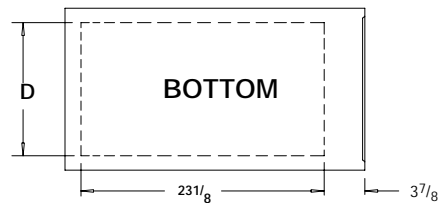
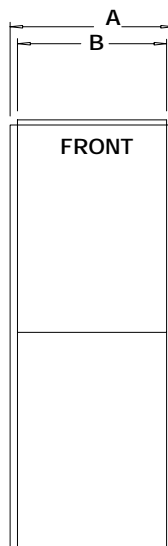
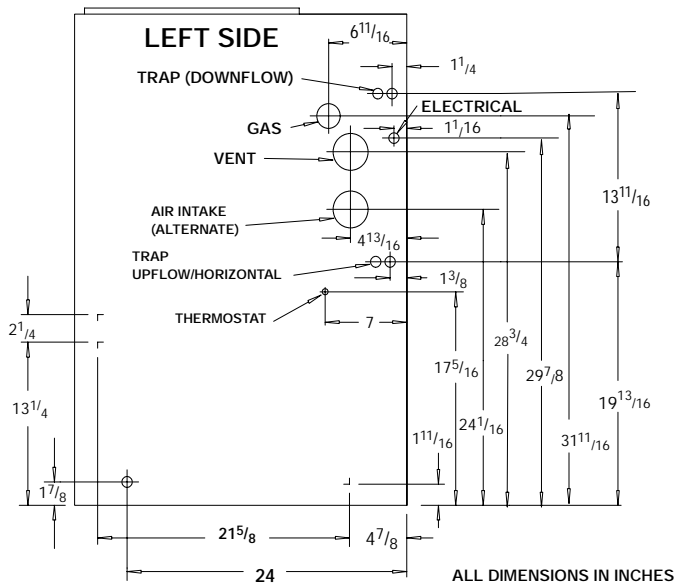

Unit Capacity	Cabinet		Bottom	Top	
	A	B	D	G	H
*9MPT050F12A	19 1/8	17 5/8	14 3/4	2 1/2	9 1/2
*9MPT075F14A	19 1/8	17 5/8	14 3/4	2 1/2	9 1/2
*9MPT100J16A	22 3/4	21 1/4	18 3/4	2 5/8	11 3/8
*9MPT125L20A	24 1/2	23	23	2 1/4	12 1/4

* Denotes Brand (T, H or C)

25-23-36A

ACCESSORIES

Model Number	Description	Used With Models
1011787 ^	Gas Conversion Kits (2-Stage) - LP (Propane) to natural gas conversion kit. Allows field conversion to natural gas.	*9MPT
1011789 ^	Gas Conversion Kits (2-Stage) - Natural gas to LP (propane) conversion Kit (includes LP high altitude kit). Allows field conversion to LP (propane) gas.	*9MPT
NAHA001PS 1009522 ^	LP Low Pressure Switch - For detecting low line pressure. Opens at 6.5" W.C. (included in NAHF002LP)	All LP *9MPT Models
NAHA001FF	Filter Kits - External filter frame. 16" x 25"	Side Return (All Furnaces) Bottom Return (All "F" 19 ¹ / ₈ " Furnaces under 1650 CFM)
NAHA001FP	External filter frame. 16" x 25" (Bulk Pack Kit - Qty 10)	
NAHA002FF	Filter Kits - Bottom return filter frame kit 20" x 25"	(All "J" 22 ³ / ₄ " Furnaces)
NAHA002FP	Bottom return filter frame kit 20" x 25" (Bulk Pack Kit - Qty 10)	
NAHA003FF	Filter Kits - Bottom or side return filter frame kit 14" x 25".	(All "B" 15 ¹ / ₂ " Furnaces)
NAHA003FP	Bottom or side return filter frame kit 14" x 25" (Bulk Pack Kit - Qty 10)	
NAHA001TK	Duct Standoff Filter Kit. To adapt 20" x 25" filter for single side return.	Side Return (All single return applications with 1650 CFM or greater) Bottom Return (All "F" 19 ¹ / ₈ " Furnaces under 1650 CFM)
NAHA001NK 612833 ^	Condensate neutralizer kit - for condensing gas furnaces	All *9MPT Furnaces If Required
NAHA036VA	Blower Upgrade Kit - Variable speed blower upgrade (consists of blower motor and electronics for 2-stage furnaces ONLY),	*9MPT050
NAHA042VA		*9MPT075
NAHA060VA		*9MPT100/125
NAHH002SB	Combustible Floor Subbase - Furnace ONLY: All 19 ¹ / ₄ " wide furnace models	*9MPT050/075
NAHH003SB	Combustible Floor Subbase - Furnace ONLY: All 22 ³ / ₄ " wide furnace models	*9MPT100
NAHH010SB	Combustible Floor Subbase - Furnace ONLY: All 24 ¹ / ₂ " wide furnace models	*9MPT125
NAHH005SB	Subbase - Furnace w/19 ¹ / ₄ " cased coil	*9MPT050/075 Counterflow furnace w/19 ¹ / ₄ " cased coil
NAHH006SB	Subbase - Furnace w/22 ³ / ₄ " cased coil	*9MPT100 Counterflow furnace w/22 ³ / ₄ " cased coil
NAHH009SB	Subbase - Furnace w/24 ¹ / ₂ " cased coil	*9MPT125
1013515^	Standard Pressure Switch Kit	*9MPT050, 075 & 100
1013166^	Standard Pressure Switch Kit	*9MPT125
1013165^	High Pressure Switch Kit	*9MPT050, 075 & 100
1013157^	High Pressure Switch Kit	*9MPT125
NAHA001CV 1011129^	3" Concentric vent kit - allows single wall penetration for 2 pipe direct vent applications (90+).	*9MPT100/125
NAHA002CV	2" Concentric vent kit allows - single wall penetration for 2 pipe direct vent applications (90+).	*9MPT050/075
NAHA001CA	Coil Adapter for Downflow Furnaces	All Downflow Models

^ Must be ordered from Service Parts

* Denotes Brand (T, H or C)