



International Comfort Products

Installation Instructions / User's Manual TSTAT0406 and TSTAT0407



4 HEAT – 2 COOL – DUAL FUEL

TSTAT0406 & TSTAT0407 - 4 WIRE CAPABLE THERMOSTAT (NAXA00101DB Daughter Board sold separately)

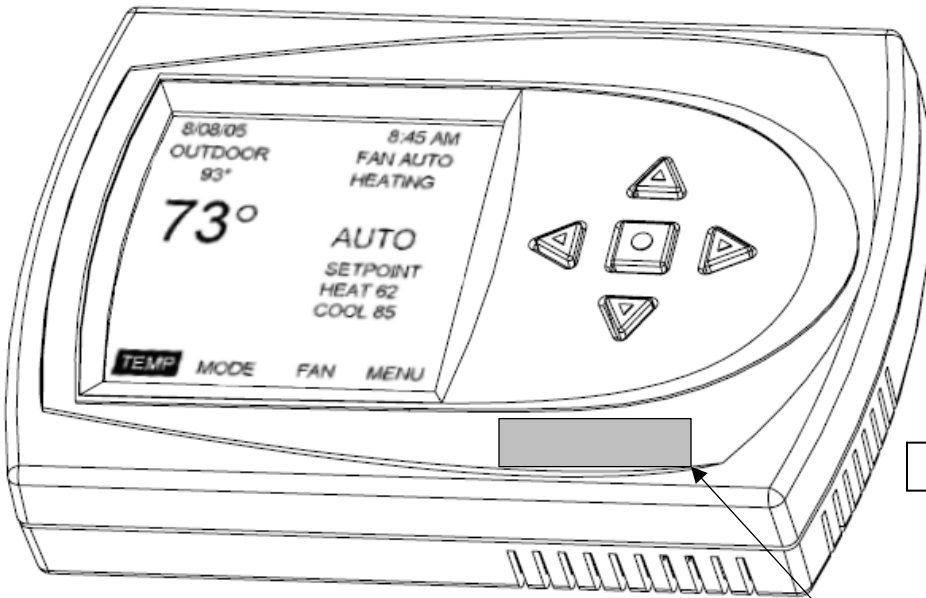

Menu Driven Display

Apply logo label here

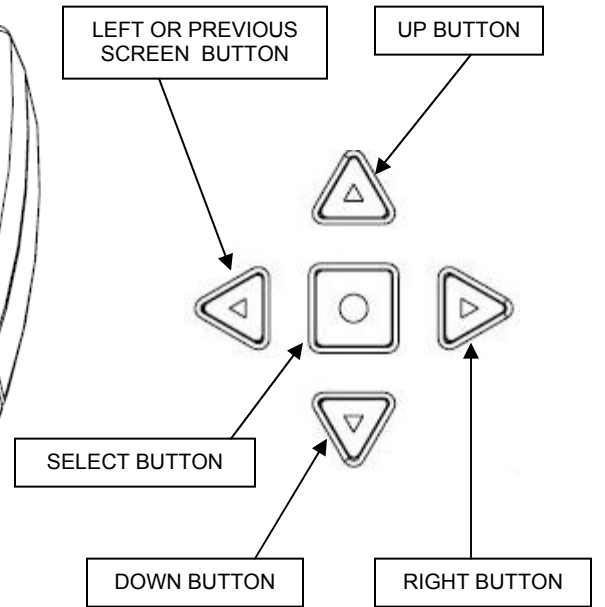

THERMOSTAT BUTTON OPERATION

NOTE: You must go through the Model Configuration menus first. If you do not configure your thermostat and go straight to the different modes you will get a "Configuration Error" code flashing at the top of the screen. To void error, run through the Configuration Mode Menus. To Enter Configuration Menu set mode to OFF, then push the up and down buttons simultaneously for 5 seconds.

TSTAT0406 AND TSTAT0407 MENU MAP

INSTALLER SETTINGS	MODEL CONFIGURATION	HEAT/COOL	SINGLE STAGE	ELECTRIC GAS
			MULTI STAGE	ELECTRIC GAS
		HEAT PUMP	SINGLE STAGE	ELECTRIC DUAL FUEL
			MULTI STAGE	ELECTRIC DUAL FUEL
ACCESSORIES	AIR FILTER	CUMULATIVE RUN TIME		HOURS
		CALENDER TIME		MONTHS
	HUMIDIFER	CUMULATIVE RUN TIME		HOURS
		CALENDER TIME		MONTHS
	UV LAMP	CUMULATIVE RUN TIME		HOURS
		CALENDER TIME		MONTHS
	ELEC. AIR CLEANER	CUMULATIVE RUN TIME		HOURS
		CALENDER TIME		MONTHS
INPUT DEALER INFO	BRAND NAME			
	FURNACE MODEL NUMBER			
	HP MODEL NUMBER			
	CONTRACTOR NAME			
	CONTRACTOR PHONE			
	SAVE		YOUR DEALER IS	
FAN WITH HEAT OPTION				
HUMIDITY OPTION (HUMIDITY SETTINGS)	HUMIDIFY ONLY			
	DEHUMIDIFY ONLY			
	AUTO			
	NONE			
RESTORE DEFAULTS				
OFFSETS	TEMPERATURE OFFSETS	TEMPERATURE OFFSET		
		REMOTE INDOOR OFFSET		
		OUTDOOR OFFSET		
		HUMIDITY OFFSET		
		ANTICIPATOR		
CYCLES PER HOUR				
PROGRAM SETTINGS	SMART RECOVERY			
	EVENTS PER DAY			
	SMART HEAT STAGING			
	COOLING LOCKOUT			
	ELECTRIC/FUNRACE LOCKOUT			
	BALANCE POINT			
SERVICE INFORMATION	FAULT STATUS			
	FAULT CODE DEFINITION		FLASH CODE 1-9	
	CLEAR FAULT HISTORY			
DOWN STAGING				
TEST MODE				
COOL TO DEHUMIDIFY				
MAIN SCREEN	RH (RELATIVE HUMIDITY)			
	TEMP			
	MODE (OPERATING MODE)			
	FAN			
	MENU (MAIN MENU)	SET DATE AND TIME	AUTO DAYLIGHT SAVING	
		HOLD (HOLD MENU)	SET DATE AND TIME	MONTH/DAY/YEAR/HOUR/MINUTE
			VACATION HOLD	
			PERMANENT HOLD	
		PROGRAM MENU	PROGRAMMING SCREEN	DAY/TIME
		FAN		
		MODE (OPERATING MODE)		
		DISPLAY HUMIDITY		
		DISPLAY DEALER INFO		
		SETTINGS (SETTING MENU)	SCREEN SETTINGS	FAHRENHEIT OR CELSIUS
				12 OF 24 HOUR CLOCK
				LANGUAGE
				CONTRAST
				BACKLIGHT ON TIME
			AUTO CHANGEOVER	AUTO CHANGEOVER TIME
				AUTO OR MANUAL CHANGE
			INTERMITTENT FAN	INTERMITTEN FAN OFF TIME
		SECURITY LOCKOUT	TEMP ADJUST ONLY	
			TOTAL KEYPAD LOCKOUT	

Heat Cool / Heat Pump / Dual Fuel Communicating Thermostat Installation and Start-up Instructions INSTALLER SETTINGS

INSTALLER SETTINGS

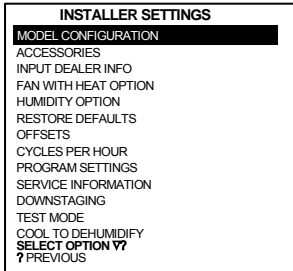

To enter the INSTALLER SETTINGS screen, the thermostat MUST be in the OFF mode and at the MAIN SCREEN press and hold the UP and DOWN buttons at the same time for 5 seconds. This will bring up the INSTALLER SETTINGS screen. The installer settings are options that are specific to a particular installation and should only be adjusted by qualified service personnel.

The INSTALLER SETTINGS options are:

- MODEL CONFIGURATION** – Defines what type of system the thermostat is controlling.
- ACCESSORIES** – What else is attached to the system and sets service alerts.
- INPUT DEALER INFO** – Allows service personnel to enter their name, phone number, and model information for display in service situations.
- FAN WITH HEAT OPTION** – In a gas furnace application, this option turns the G output on when the heat is on or off. G is default to ON when electric heat is selected.
- HUMIDITY OPTION** – In thermostats with an internal humidity sensor (TSTAT0407) this determines if humidification or dehumidification will be energized. (Not shown on systems without humidity sensor)
- RESTORE DEFAULTS** – This will restore all factory defaults.
- OFFSETS** – Allows setting of permanent offsets to the temperatures and humidity to compensate for room differences or measurement differences.
- CYCLES PER HOUR** – limits the cycling of the system to a set maximum per hour to reduce short cycling and extend system life.
- PROGRAM SETTINGS** – Sets custom operation of the programming feature.
- SERVICE INFORMATION** – This menu can bring up current faults along with last three faults of the Comfort Alert diagnostic module. It also has a list of fault code definitions and a method of clearing the faults out of the thermostat memory.
- DOWN STAGING** – You can turn down staging on or off. Default is on. (Refer to down staging section for details)

Staging Properties: Thermostat models TSTAT0406 & TSTAT0407 use advanced logic to control a two-stage heating or cooling system for better home comfort and higher efficiency. The thermostat continuously monitors set point, room temperature, anticipator setting, and temperature rate-of-change. Considering all the conditions, the thermostat decides which stage (high or low) the system should be running for better home comfort and higher efficiency. It is possible that the thermostat will keep the system running for longer periods of time in low stage. This is normal, as the thermostat works to achieve higher efficiency and better home comfort. The advanced logic operates in all modes and controls the system for ramp up (off→low stage→high stage) and ramp down (high stage→low stage→off). There are NO differentials (dead bands) to set. Simply enter your desired room temperature and the thermostat will hold the room temperature to within ¼ °F from setpoint.

TEST MODE – Allows forced operation of all the different heating and cooling modes of the thermostat based on The model configuration selected. Also shortens or eliminates the short cycle timer.

COOL TO DEHUMIDIFY – Uses the HVAC equipment in cooling to dehumidify the conditioned space. This feature is used when the system does not have variable speed capabilities.

MODEL CONFIGURATION

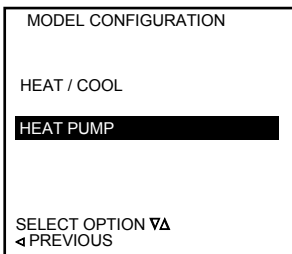

Highlighting MODEL CONFIGURATION, in the INSTALLER SETTINGS screen, and pressing SELECT button will bring up the first MODEL CONFIGURATION screen.

The first option asks if the system is a HEAT PUMP or a HEAT/COOL system. Highlighting the proper configuration and pressing SELECT sets up the system and brings up the next configuration screen.

Highlighting the proper setting for single stage systems or multi stage systems and pressing the SELECT button sets the system for the proper operation.

If the system is configured for HEAT/ COOL operation and single or multi stage the next menu, ELECTRIC or GAS, is where you will choose your source of heat. By pressing the SELECT button you will return the display to the INSTALLER SETTINGS screen.

NOTE: If you have selected furnace and you wish to have G energized along with W you must turn the Fan with Heat option to on.

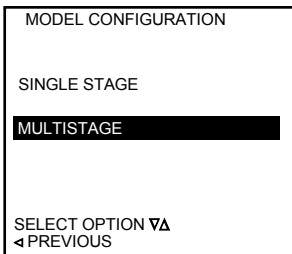

If the system is configured for HEAT PUMP operation and single or multi stage the next menu, ELECTRIC or DUAL FUEL, is where you will choose your source of heat. For HEAT PUMP systems, the ELECTRIC OR DUAL FUEL configuration screen allows setting for gas or electric furnaces. If the auxiliary heat system is

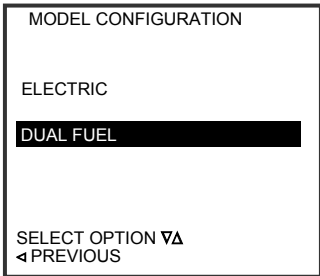

gas or oil, highlight the DUAL FUEL option. For electric add-on heat, highlight ELECTRIC. Pressing the SELECT button finishes the system configuration and returns the display to the INSTALLER SETTINGS screen.

NOTE: The configuration steps must be done at the initial installation of the thermostat or CONFIGURATION ERROR will appear on the top line of the MAIN SCREEN.

NOTE: YOU MUST HAVE AN OUTDOOR SENSOR FOR A DUAL FUEL SYSTEM TO OPERATE CORRECTLY.

ACCESSORIES

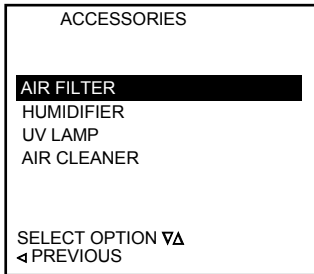

Highlighting the ACCESSORIES option in the INSTALLER SETTINGS screen and pressing SELECT will bring up the ACCESSORIES screen. This allows identification of add on accessories and sets a service schedule for them.

Highlighting an accessory and pressing SELECT will bring up the NOTIFICATION METHOD screen.

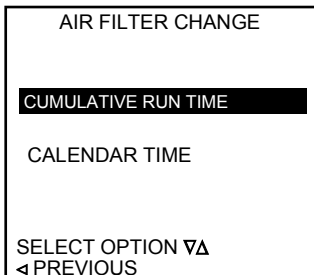

This screen allows selection of notification by elapsed time (Calendar) or by hours actually run (CUMULATIVE RUN TIME)

Highlighting CUMULATIVE RUN TIME and pressing the SELECT button will bring up the RUN HOURS SCREEN.

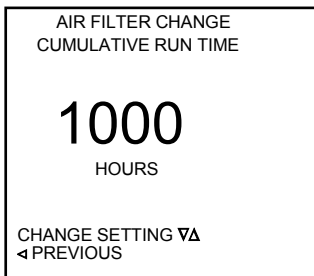

The thermostat will keep track of the hours the system is actually running and compare that number to the numbers of hours set in the CUMULATIVE RUN HOURS screen. When the hours are met, the thermostat will display a message on the top line of the MAIN screen. In the case of the AIR FILTER, the message will say CHANGE AIR FILTER. (See MAIN SCREEN _ TOP LINE for other messages)

Use the UP and DOWN buttons to set the hours from OFF to the maximum time allowed. (See defaults table for values)

Press the SELECT button to activate and save the settings. The thermostat will automatically return the display to the ACCESSORIES screen.

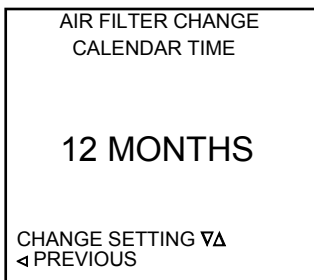

Highlighting the CALENDAR TIME option and pressing the SELECT brings up the CALENDAR TIME screen.

Use the UP and DOWN buttons to change the Calendar time before an alert is set. The time can be set from OFF to the maximum time for the particular accessory. When the desired time is displayed, press the SELECT button to activate and save the setting. The thermostat will automatically return the display to the ACCESSORY screen.

INPUT DEALER INFO

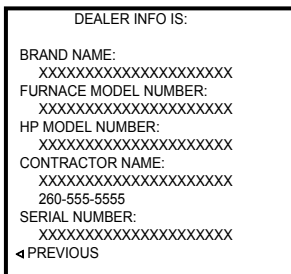
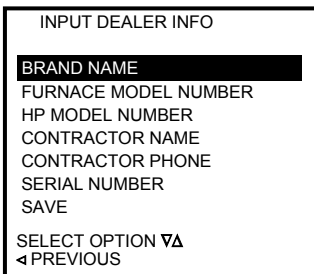

Highlighting INPUT DEALER INFO and pressing SELECT brings up the DEALER INFORMATION screen.

The options are:

- BRAND NAME
- FURNACE MODEL NUMBER
- HEAT PUMP MODEL NUMBER
- CONTRACTOR NAME
- CONTRACTOR PHONE
- SERIAL NUMBER
- SAVE

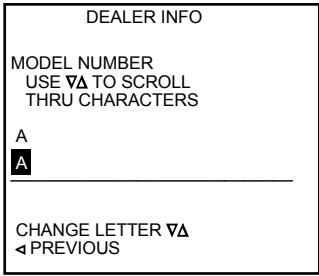

Highlighting the type of information to enter and pressing SELECT button brings up the DATA ENTRY screen for that option. Use the UP and DOWN buttons to scroll through the letters and numbers and use the RIGHT button to move to the next space. When all desired information is entered, press the SELECT button to save and return to the DEALER INFORMATION screen. When all desired dealer information has been entered, highlight the SAVE option and press the SELECT button.

The screen will display all of the entered information. If changes are needed, pressing the LEFT button will return the display to the DEALER INFORMATION SCREEN and corrections can be made. Use the RIGHT button to move across the line without changing the previous information. If changes are not necessary, press the SELECT button when the information is displayed and the display will return to the INSTALLER SETTINGS screen.

FAN WITH HEAT OPTION

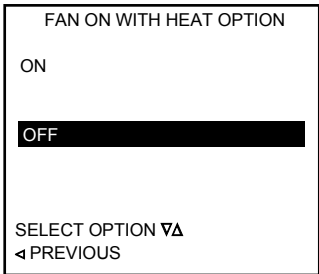

Highlighting the FAN WITH HEAT OPTION in the INSTALLER SETTINGS screen and pressing the SELECT button will bring up the FAN WITH HEAT screen. Highlighting the ON option and pressing the SELECT button will activate this option. When FAN WITH HEAT is active, the thermostat will turn on the fan output (G) whenever there is a call for heat. Without this option active, there is no call for FAN (G) when heat is on and the thermostat is configured for Gas heat. There is always a FAN (G) output when there is a Y output in Heat Pump applications and when the system is configured for electric heat.

HUMIDITY OPTION (HUMIDITY SETTINGS) – TSTAT0407 Model Only

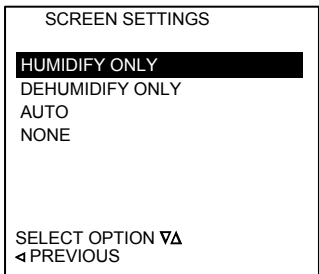

Highlighting the HUMIDITY OPTION in the INSTALLER SETTINGS screen and pressing the SELECT button will bring up the HUMIDITY SETTINGS screen. The humidity options are:
 HUMIDIFY ONLY – Used when only a humidifier is attached to the system
 DEHUMIDIFY ONLY – Used when only a dehumidifier is attached to the system or the system has self dehumidification capability.
 AUTO – Allows for H output to be active for humidification in heating and dehumidification in cooling. The humidify set point will only be displayed in heating mode and the dehumidify set point will only be displayed in cooling mode.
 NONE – Used when no humidifier or dehumidifier is attached.
 The settings for operation of the attached equipment are accessed from the MAIN screen by highlighting the RH option and pressing the SELECT button. To have the humidity displayed on the main screen select MENU/DISPLAY HUMIDITY from the main screen.

RESTORE DEFAULTS

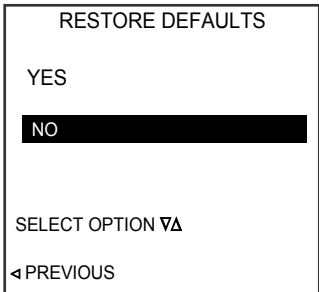

Highlighting The RESTORE DEFAULTS option in the INSTALLER SETTINGS screen and pressing the SELECT button will bring up the RESTORE DEFAULTS screen. By using the UP and DOWN buttons to highlight the YES option and pressing the SELECT button, all settings are returned to factory default condition.

NOTE: The configuration settings – HEAT COOL/HEAT PUMP, SINGLE/MULTI, GAS/ELECTRIC are **NOT** reset by this command. The thermostat keeps the last valid settings. If these need to be changed, it must be done through the CONFIGURATION screen.

OFFSETS

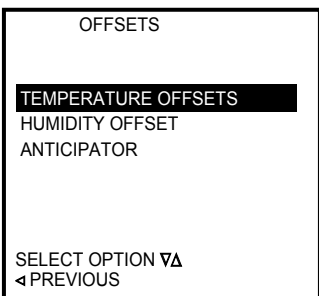

Highlighting the OFFSETS option in the INSTALLER SETTINGS screen and pressing the SELECT button will bring up the OFFSETS SCREEN. Offsets are used when the temperature on the thermostat is not representative of the room temperature the system is controlling. This may be due to many factors including position of the thermostat, room air flow, sunlight on the thermostat and others.
 The OFFSET options are:
 TEMPERATURE OFFSETS – This can apply an offset of +/- 5 degrees to change the temperature reading from the internal temperature sensor, the external temperature sensor, and the outdoor temperature sensor.
 HUMIDITY OFFSET – This can apply an offset of +/- 5% to the relative humidity read from the internal sensor
 ANTICIPATOR – This can be set from 0 to 4 and adjusts the sensed temperature with running time to help prevent overshoot in temperature regulation.

TEMPERATURE OFFSETS

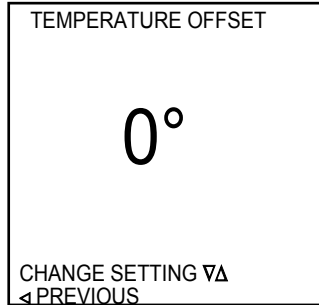
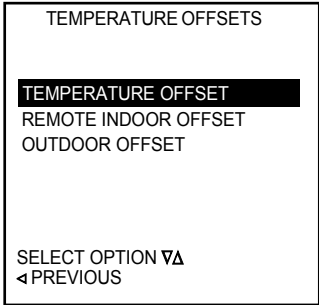

Highlighting the TEMPERATURE OFFSETS and pressing SELECT will bring up the TEMPERATURE OFFSET screen. Selecting which offset to adjust and pressing SELECT will bring up the appropriate screen for the adjustment. Pressing the UP and DOWN buttons will change the offset. Pressing the SELECT button applies the offset to the temperature selected.

HUMIDITY OFFSETS – Model TSTAT0407 Only

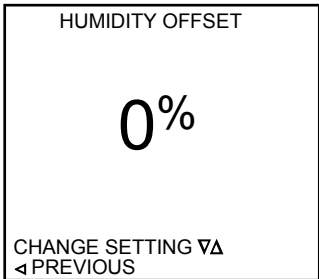

Highlighting the HUMIDITY OFFSET option and pressing SELECT will bring up the HUMIDITY OFFSET screen. Pressing the UP and DOWN buttons will change the humidity value displayed and used in thermostats equipped with an internal humidity sensor. Pressing the SELECT button will apply the offset to the humidity.

ANTICIPATOR

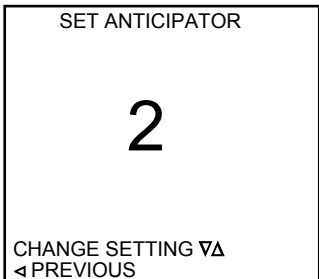

Highlighting the ANTICIPATOR and pressing the SELECT button in the OFFSETS screen will bring up the SET ANTICIPATOR screen. The anticipator can be adjusted from 1 to 9. The 9 setting adjusts the most. This adjustment is applied in systems where the room temperature overshoots the set temperature at turn off of the system. The UP and DOWN buttons will adjust the ANTICIPATOR and the SELECT button will apply the setting.

CYCLES PER HOUR

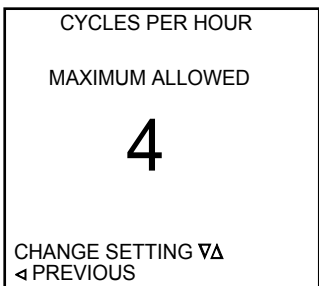

Highlighting the CYCLES PER HOUR option and pressing the SELECT button will bring up the CYCLES PER HOUR screen. Pressing the UP and DOWN buttons can adjust the CYCLES PER HOUR to either 4 or 6. If set to 4 the thermostat will not allow a cycle to start until 15 minutes have passed from the start of the last cycle. Setting to 6 will make the system wait 10 minutes before starting the next cycle. The time is measured from start of a cycle to the start of the next cycle, and not the off time between cycles.

PROGRAM SETTINGS

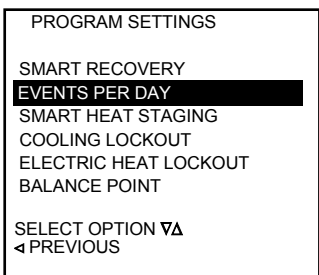

Highlighting the PROGRAM SETTINGS option in the SETTINGS screen and pressing SELECT will bring up the PROGRAM SETTINGS screen. The PROGRAM SETTINGS options are:
SMART RECOVERY – The thermostat looks ahead to the next programmed time and temperature and adjusts its operation to reach the desired temperature at the programmed time. The normal operation is to change the set point at the set time and let the system adjust the temperature starting at the set event time.
EVENTS PER DAY – Sets the number of programmed events per day to either 2 or 4.
NOTE: OUTDOOR SENSOR REQUIRED FOR NEXT THREE SETTINGS
COOLING LOCKOUT – Does not allow cooling when the outside temperature is below a specified temperature
ELECTRIC HEAT LOCKOUT/FURNACE LOCKOUT when configured for MULTI FUEL – Does not allow electric heat on a heat pump system or furnace to come on when the outdoor temperature is **above** a specified temperature.

HEAT PUMP LOCKOUT – Does not allow the heat pump to operate when the outdoor temperature is **below** a specified temperature.

SMART RECOVERY

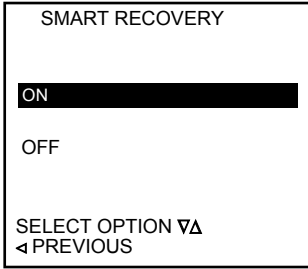

Highlighting the SMART RECOVERY option and pressing SELECT will bring up the SMART RECOVERY screen. Highlighting ON or OFF and pressing the SELECT button will turn smart recovery on or off and return the display to the PROGRAM SETTINGS screen. When SMART RECOVERY is ON, the thermostat tries to adjust the set temperature in advance of a programmed event to get the temperature adjusted to the set point at the time of the event. For example, if the set temperature is set for 65 degrees at 3PM and the next programmed event sets the temperature to 70 degrees at 5PM, the thermostat will start the system before 5PM to achieve 70 degrees at 5PM. The thermostat assumes a change rate of 6 degrees per hour so it would start at about 4:10 PM and slowly raise the set temperature to 70 at 5PM.

EVENTS PER DAY

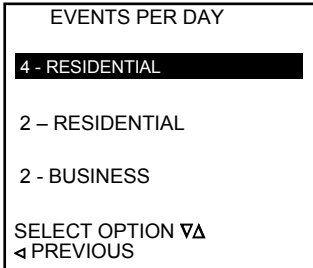

Highlighting the EVENTS PER DAY option and pressing SELECT will bring up the EVENTS PER DAY screen. Pressing the UP or DOWN buttons will set the events per day to 2 or 4 and business or residential. This selection determines how many programmed events are available each day.

The Residential events are WAKE, LEAVE, RETURN, SLEEP for 4 events or WAKE and SLEEP for 2 events. The Business events are named ACTIVE and IDLE.

COOLING LOCK OUT (OUTDOOR SENSOR REQUIRED)

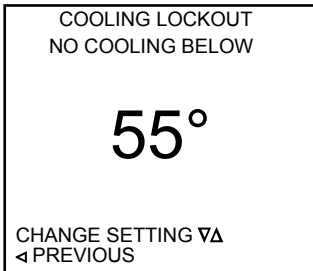

Highlighting the COOLING LOCKOUT option in the PROGRAM SETTINGS screen and pressing the SELECT button will bring up the COOLING LOCKOUT SCREEN. This setting can be set from NONE to 55 degrees. When there is an outdoor thermistor attached and the outdoor temperature is below the set Cooling Lockout point, the cooling will not operate. Pressing the UP and DOWN buttons will change the setting and pressing the SELECT button will apply the setting.

ELECTRIC HEAT /FURNACE LOCKOUT (OUTDOOR SENSOR REQUIRED)

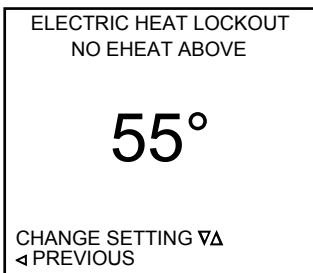

Highlighting the ELECTRIC HEAT LOCKOUT (FURNACE LOCKOUT if configured as GAS or DUAL FUEL) option and pressing the SELECT button will bring up the ELECTRIC HEAT/FURNACE LOCKOUT screen. In a heat pump system with an outdoor thermistor, this setting allows the thermostat to lockout the electric heat when the outdoor temperature is above the Lockout set temperature. If your system is configured as a furnace, it will lockout the furnace when the outdoor temperature is above the lockout set temperature. Pressing the UP and DOWN buttons can change the setting temperature from NONE to 60 degrees. Pressing the SELECT button will apply the setting and return the display to the PROGRAM SETTINGS screen.

BALANCE POINT (OUTDOOR SENSOR REQUIRED) – USED IN DUAL FUEL MODE

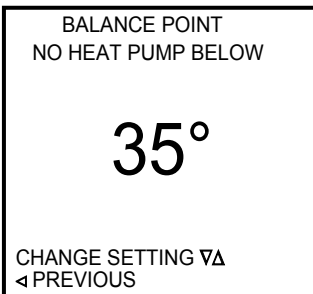

Highlighting the BALANCE POINT option and pressing the SELECT button will bring up the BALANCE POINT screen. In a heat pump system with an outdoor thermistor, this setting allows the thermostat to lockout the heat pump when the outdoor temperature is below the Lock Out set temperature. Pressing the UP and DOWN buttons can change the setting temperature from NONE to 55 degrees. Pressing the SELECT button will apply the setting and return the display to the PROGRAM SETTINGS screen.

SERVICE INFORMATION

```

SERVICE INFORMATION
FAULT STATUS
FAULT CODE DEFINITION
CLEAR FAULT HISTORY

SELECT OPTION ▾▲
◀ PREVIOUS
    
```

Highlighting the SERVICE INFORMATION option and pressing the SELECT button brings up the SERVICE INFORMATION screen.

Pressing the UP or DOWN button will alternate between FAULT STATUS, FAULT CODE DEFINITION and CLEAR FAULT HISTORY. Selecting FAULT STATUS allows the FAULT STATUS screen to be selected. Selecting CLEAR FAULT HISTORY allows the CLEAR FAULT HISTORY screen to be selected. Pressing the SELECT button when the desired option is highlighted enables that option.

FAULT STATUS

```

FAULT STATUS
ACTIVE FAULT:
1 FLASH-LONG RUN TIME

LAST 3 FAULTS:
3 FLASH-SHORT CYCLING
5 FLASH-OPEN HI V CKT
9 FLASH-LOW VOLTAGE

? PREVIOUS
    
```

Highlighting the FAULT STATUS option and pressing the SELECT button brings up the FAULT STATUS screen. The ACTIVE FAULT indicates the active fault (if any) that is currently being transmitted from the “L” output from the Comfort Alert Module. The LAST 3 FAULTS indicates the last 3 faults that were stored in memory and transmitted from the Comfort Alert module from the most recent to the latest.

FAULT CODE DESCRIPTION

```

FAULT CODE DEFINITION
FLASH CODE 1
FLASH CODE 2
FLASH CODE 3
FLASH CODE 4
FLASH CODE 5
FLASH CODE 6
FLASH CODE 7
FLASH CODE 8
FLASH CODE 9

SELECT OPTION ▾▲
◀ PREVIOUS
    
```

Highlighting the FAULT CODE DEFINITION option and pressing the SELECT button brings up the FAULT CODE DEFINITION screen.

Pressing the UP or DOWN button will alternate between FLASH CODE 1 THRU 9. Pressing the SELECT button when the desired selection is highlighted activates that option. Selecting one of the FLASH CODE options and pushing ENTER button will display the definition for the selected FLASH CODE.

CLEAR FAULT HISTORY

```

CLEAR FAULT HISTORY
YES
NO

SELECT OPTION ▾▲
◀ PREVIOUS
    
```

Highlighting the CLEAR FAULT HISTORY option and pressing the SELECT button brings up the CLEAR FAULT HISTORY screen.

Pressing the UP or DOWN button will alternate between NO & YES. Selecting NO will not change any of the current adjustable settings and will return to the previous menu. Selecting YES will erase the Fault Code History from the thermostat’s memory. Pressing the SELECT button when the desired option is highlighted activates that option.

SERVICE NEEDED SCREEN

```

SERVICE NEEDED
CALL:
XXXXXXXXXXXXXXXXXX
260-555-5555
BRAND:
XXXXXXXXXXXXXXXXXX
MODEL NUMBER:
123ABC456DEF
SERIAL NUMBER:
123ABC456D
FAULT:
5 FLASH - OPEN HI V CKT
◀ PREVIOUS
    
```

Anytime there is an active fault on the Comfort Alert module and the “L” input is wired to the TSTAT0406, TSTAT0407 thermostats or NAXA00101DB Daughter Board, the thermostat display will display the SERVICE NEEDED screen with the corresponding Comfort Alert Fault. The CONTRACTOR NAME, CONTRACTOR PHONE NUMBER, MODEL NUMBER and SERIAL NUMBER of the outdoor unit will be displayed also if the information has been programmed into the thermostat at the INPUT DEALER INFO screen in the INSTALLER SETUP menu.

To exit the SERVICE NEEDED screen while there is an active fault, push the ◀ PREVIOUS button. Pushing the ◀ PREVIOUS button resets the active fault counter within the thermostat. If the fault is still active and the fault is validated after the proper recognition timing, the fault will again be displayed in the SERVICE NEEDED screen.

DOWN STAGING

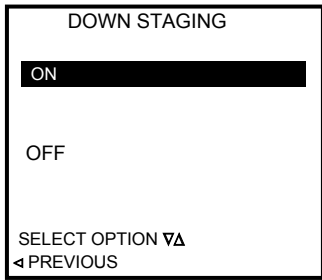

Highlighting the DOWN STAGING option and pressing the SELECT button brings up the DOWN STAGING screen. Pressing the UP or DOWN button will alternate between ON & OFF. Selecting ON will allow the thermostat to down stage to a lower heating or cooling stage as the ambient temperature gets closer to the temperature setpoint. Selecting OFF forces the thermostat to satisfy the call for heat or cool on the highest active stage without down staging. Pressing the SELECT button when the desired option is highlighted activates that option.

TEST MODE

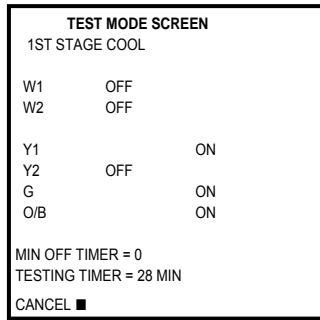
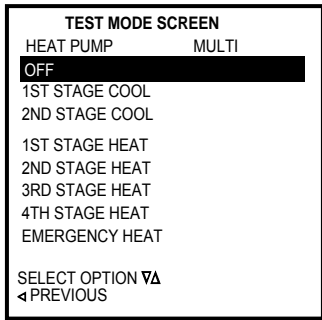

Highlighting the TEST MODE option and pressing the SELECT button brings up the TEST MODE screen. Pressing the UP or DOWN button will alternate between OFF and a list of all the heating and cooling stages available in the model configuration you have programmed into the thermostat. Pressing the SELECT button when the desired option is highlighted activates that option. Selecting the OFF option will not change any settings and will return to the previous screen. Selecting one of the heating or cooling stages options will go to the associated screen and show the list of thermostat inputs and display their OFF or ON status as well as the cooling or heating stage selected at the top of the screen. The minimum off timer is set to zero and the testing timer is set to 30 minutes. The screen will flash red then blue throughout the testing process until the testing timer is satisfied or the center CANCEL button is pushed.

COOL TO DEHUMIDIFY

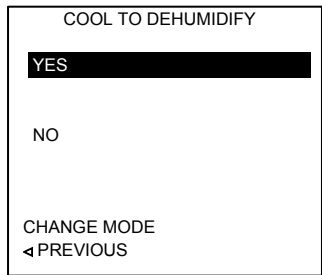

Highlighting the COOL TO HUMIDIFY option and pressing the SELECT button brings up the COOL TO DEHUMIDIFY screen. Pressing the UP or DOWN button will alternate between YES & NO. Selecting YES will allow the HVAC equipment in cooling to dehumidify the conditioned space. This feature is used when the system does not have variable speed capabilities. This feature energizes the cooling outputs (Y1, G & O) and the H output whenever the need for dehumidification is needed. This feature is only active when there is no active call for heating or cooling. Selecting NO does not allow this feature to be active at any time. Pressing the SELECT button when the desired option is highlighted activates that option.

COMFORT ALERT™ MODULE FAULT CODES

Status LED	Status LED Description	Status LED Troubleshooting Information
Green "POWER"	Module has power	Supply voltage is present at module terminals
Red "TRIP"	Thermostat demand signal Y is present, but the compressor is not running.	<ol style="list-style-type: none"> Compressor protector is open <ul style="list-style-type: none"> Check for high head pressure Check compressor supply voltage Outdoor unit power disconnect is open Compressor circuit breaker or fuse(s) is open. Broken wire or connector is not making contact Low Pressure switch open if present in system Compressor contactor has failed open.
Yellow "ALERT" Flash Code 1	Long Run Time Compressor is running extremely long run cycles	<ol style="list-style-type: none"> Low refrigerant charge Evaporator blower is not running <ul style="list-style-type: none"> Check blower relay coil and contacts Check blower motor capacitor Check blower motor for failure or blockage Check evaporator blower wiring and connectors Check indoor blower control board Check thermostat wiring for open circuit Evaporator coil is frozen <ul style="list-style-type: none"> Check for low suction pressure Check for excessively low thermostat setting Check evaporator airflow (coil blockages or return air filter) Check ductwork or registers for blockage Faulty metering device <ul style="list-style-type: none"> Check TXV bulb installation (size, location and contact) Check if TXV/fixed orifice is stuck closed or defective Condenser coil is dirty Liquid line restriction (filter drier blocked if present in system) Thermostat is malfunctioning <ul style="list-style-type: none"> Check thermostat sub-base or wiring for short circuit Check thermostat installation (location, level) Comfort Alert Module failure
Yellow "ALERT" Flash Code 2	System Pressure Trip Discharge or suction pressure out of limits or compressor overloaded	<ol style="list-style-type: none"> High head pressure <ul style="list-style-type: none"> Check high pressure switch if present in system Check if system is overcharged with refrigerant Check for non-condensable in system Condenser coil poor air circulation (dirty, blocked, damaged) <ul style="list-style-type: none"> Condenser fan is not running <ul style="list-style-type: none"> Check fan capacitor Check fan wiring and connectors Check fan motor for failure or blockage Return air duct has substantial leakage If low pressure switch present in system, check Flash Code 1 information

Status LED	Status LED Description	Status LED Troubleshooting Information
Yellow "ALERT" Flash Code 3	Short Cycling Compressor is running only briefly	<ol style="list-style-type: none"> Thermostat demand signal intermittent Time delay relay or control board defective If high pressure switch present, go to Flash Code 2 information If low pressure switch present, go to Flash Code 1 information
Yellow "ALERT" Flash Code 4	Locked Rotor	<ol style="list-style-type: none"> Run Capacitor has failed Low line voltage (contact utility if voltage disconnect is low) Excessive liquid refrigerant in compressor Compressor bearings are seized <ul style="list-style-type: none"> Measure compressor oil level
Yellow "ALERT" Flash Code 5	Open Circuit	<ol style="list-style-type: none"> Outdoor unit power disconnected Compressor circuit breaker or fuse(s) open Compressor contactor has failed open <ul style="list-style-type: none"> Check compressor contactor wiring and connectors Check for compressor contactor failure (burned, pitted or open) Check wiring and connection between supply and compressor Check for low pilot voltage at compressor contactor coil High pressure switch is open and requires manual reset Open circuit in compressor supply wiring or connections Unusually long compressor protector reset time due to extreme ambient temperature Compressor windings are damaged <ul style="list-style-type: none"> Check compressor motor winding resistance
Yellow "ALERT" Flash Code 6	Open Start Circuit	<ol style="list-style-type: none"> Run capacitor has failed Open circuit in compressor start winding or connections <ul style="list-style-type: none"> Check wiring and connections= between supply and the compressor "S" terminal Compressor start winding is damaged <ul style="list-style-type: none"> Check compressor motor winding resistance
Yellow "ALERT" Flash Code 7	Open Run Circuit Current only in start circuit	<ol style="list-style-type: none"> Open circuit in compressor run wiring or connections <ul style="list-style-type: none"> Check wiring and connectors between supply and the compressor "R" terminal Compressor run winding is damaged <ul style="list-style-type: none"> Check compressor motor winding resistance
Yellow "ALERT" Flash Code 8	Welded Contactor	<ol style="list-style-type: none"> Compressor contactor has failed closed Thermostat demand signal not connected to module
Yellow "ALERT" Flash Code 9	Low Voltage Control circuit < 17 VAC	<ol style="list-style-type: none"> Control circuit transformer is overloaded Low line voltage (contact utility if voltage at disconnect is low) <ul style="list-style-type: none"> Check wiring connections

Flash Code number corresponds to a number of LED flashes, followed by a pause and then repeated. TRIP and ALERT LED's flashing at the same time means control circuit voltage is too low for operation.

MAIN SCREEN

MAIN SCREEN

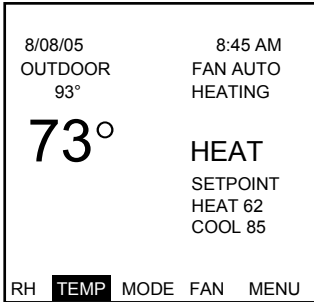

The Thermostat operation runs from the main screen. With the exception of the SERVICE NEEDED SCREEN, the display will revert to the Main Screen in 3 minutes if no buttons are pressed. The Main Screen displays the actual Temperature, the current MODE (HEAT, EHEAT, COOL, AUTO, OFF), and the temperature set points (Unless the MODE is set to OFF). If there is an Outdoor thermistor connected, the outdoor temperature is displayed. If the thermostat has Humidity sensing capability, the humidity may be displayed. HEATING will be displayed as a flashing icon under the FAN mode display on the main screen whenever there is an active heating thermostat call. COOLING will be displayed as a flashing icon under the FAN mode display on the main screen whenever there is an active cooling thermostat call. The top line of the MAIN SCREEN will normally display the time and date, but if exceptional conditions exist, the top line is used to display the condition. For example, if there is a HOLD set, the indication HOLD UNTIL (TIME DATE) or PERMANENT HOLD will be flashed on the top line. If there are alerts from the alarm settings for filter or other maintenance, those are displayed on the top line. The bottom line is a menu group. These are selectable by using the Right and Left buttons to move the cursor and pressing the center SELECT button.

TOP LINE

- TIME and DATE – Normal operation
- CONFIGURATION ERROR – The thermostat was not correctly set up when installed.
- HOLD UNTIL (DATE and TIME) – Thermostat is in a temporary or Vacation Hold
- PERMANENT HOLD – Thermostat is in a permanent hold condition.
- CHANGE AIR FILTER – Maintenance time for air filter
- CHANGE UV LAMP – Maintenance time for UV Lamp
- SERVICE TIME – Maintenance time for system
- SERVICE HUMIDIFIER – Maintenance time for humidifier .

NOTE: these service times are set in the INSTALLER SCREENS

- SMART RECOVERY – The system is starting early to achieve temperature at the programmed time.
- INTERMITTENT FAN – The fan is running its cycle set by the intermittent fan option.
- COMMUNICATION ERROR – Only used in systems with the NAXA00101DB daughter board.
- LOCKED – The thermostat is LOCKED. You will need to enter the unlock code.
- DEFROST ERROR –If unit is in defrost 15 minutes after initiation, the thermostat will flash the SERVICE NEEDED screen and display the EXCESS DEFROST TIME as the fault. The thermostat will only use Auxiliary heat outputs during this lockout.

NOTE: All errors and reminders shown in the top line are alternately flashed at 1 second intervals with the date and time.

BOTTOM LINE contains a group of selectable menus.

- RH (where used) displays the relative humidity and allows selection of humidity operation points.
- TEMP sets a temporary hold. This will change the set point until the next programmed temperature change point. This can change to CANCEL HOLD when a hold is active, RESET ALARM when an alarm or fault is active, and CANCEL ERROR when a DEFROST ERROR is present.
- MODE allows you to select which operating mode to use. HEAT, COOL, EHEAT, AUTO, or OFF.
- FAN allows selection of fan operation. AUTO, ON, or PROGRAMMED.
- MENU takes you to the MAIN MENU of options.

RH (RELATIVE HUMIDITY) – Model TSTAT0407 Only

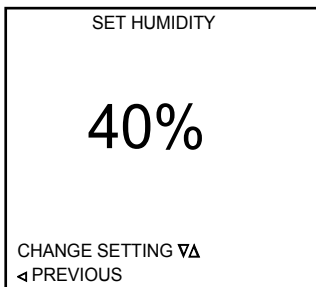
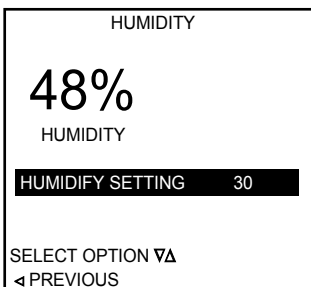

Selecting RH and pressing the SELECT button will bring up the HUMIDITY screen on thermostats equipped with a humidity sensor. If the thermostat does not have a humidity sensor, this position will allow display of dealer information. The HUMIDIFY or DEHUMIDIFY settings can be changed by using the SELECT Button to choose the HUMIDIFY SETTING or DEHUMIDIFY SETTING box.

NOTE: In order to be able to select a Humidify or Dehumidify setting, the HUMIDITY OPTION must be set for HUMIDIFY ONLY, DEHUMIDIFY ONLY or AUTO in the HUMIDITY SETTINGS screen in the INSTALLER SETTINGS menu.

Use the UP and DOWN buttons to change the HUMIDIFY or DEHUMIDIFY setpoints within the preset ranges. When the desired setting is reached, press the SELECT button. The H output on the thermostat will activate in the humidification mode when the sensed ambient humidity is below the setpoint selected and there is an active call for heating. The H output on the thermostat will activate in the dehumidification mode when the sensed ambient humidity is above the setpoint selected and there is an active call for cooling. HUMIDIFY ONLY option displays only HUMIDIFY SETTING DEHUMIDIFY ONLY option displays only DEHUMIDIFY SETTING AUTO option displays both HUMIDIFY and DEHUMIDIFY SETTINGS
Note: Please note wiring diagrams for the humidifier and dehumidifier options to ensure proper system operation.

TEMP

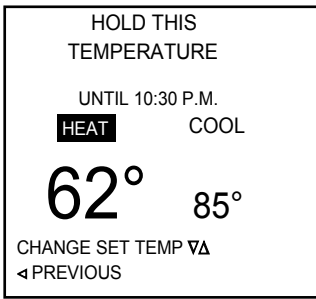

Selecting TEMP and pressing the SELECT button will bring up the HOLD THIS TEMPERATURE screen. If the mode is set for OFF, the temperature will be the last mode set. Shown is the AUTO mode.
 NOTE: Pressing the UP or DOWN button from the MAIN screen when in any mode but OFF will bring up this screen.

Use the UP and DOWN buttons to change the set temperature for HEAT and COOL. When the desired temperature is reached, press the SELECT button. The COOL option will be highlighted if in HEAT and the mode is set to AUTO or the selection will be saved and the thermostat will enter a HOLD condition. The new settings will be used until the next programmed time is reached or the CANCEL HOLD is selected on the main screen. The next programmed time is shown on the screen. The next programmed time is also displayed in a flashing message on the TOP LINE of the main screen.

MODE (OPERATING MODE)

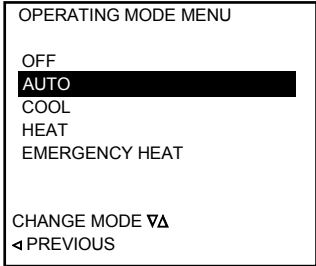

Highlighting the MODE option and pressing the SELECT button will bring up the Operating Mode screen. Use the UP and DOWN button to highlight the desired operation mode and press the SELECT button to activate the desired operating mode. NOTE: the EMERGENCY HEAT mode is only available when the thermostat is configured for HEAT PUMP. The CONFIGURATION screen is in the INSTALLER SETTINGS screen.
 The AUTO setting allows the setting of a HEAT and COOL temperature and the thermostat will set the appropriate mode for maintaining the desired temperature.

FAN

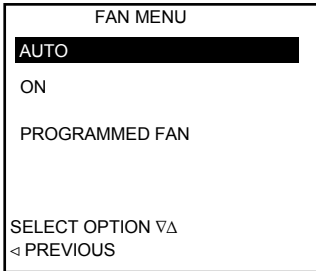

Highlighting the FAN and pressing the SELECT button will bring up the FAN MODE screen. The options are:

- AUTO – The thermostat will decide when the fan should be on based on the operation of the heat and cool outputs.
- ON – The fan is on continuously
- PROGRAMMED FAN – the fan will either be ON or AUTO based on the setting in the Program Screen.

MENU (MAIN MENU)

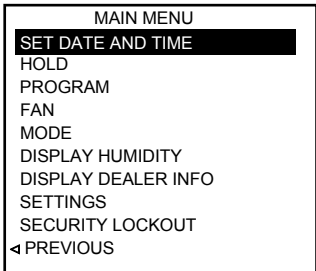

Highlighting the MENU and pressing the SELECT button will bring up the MAIN MENU screen. Highlighting one of the options by using the UP and DOWN buttons will bring up the appropriate screen for that option. Pressing the LEFT button will take you back to the Main screen.

NOTE: Products without Humidity sensors will not show DISPLAY HUMIDITY.

SET DATE AND TIME

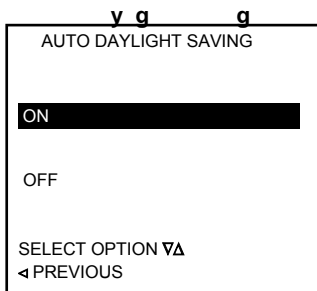
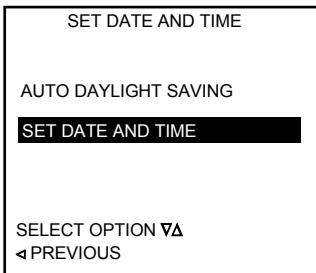

Highlighting the SET DATE AND TIME and pressing the SELECT button will bring up the SET DATE AND TIME SCREENS. The first screen gives an option of setting the AUTO DAYLIGHT SAVING time selection or the SET DATE AND TIME option.

Highlighting the AUTO DAYLIGHT SAVING selection and pressing the SELECT button will bring up the screen for selecting the AUTO DAYLIGHT SAVINGS TIME option.

Highlighting the OFF and pressing the SELECT button will turn OFF the automatic adjustment for daylight savings time. Highlighting ON and pressing the SELECT button will turn on the automatic adjustment for daylight savings time.

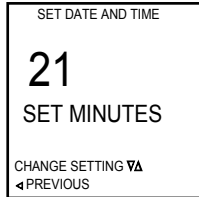
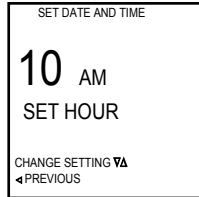
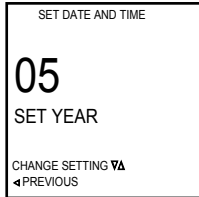
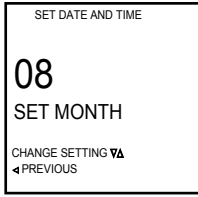
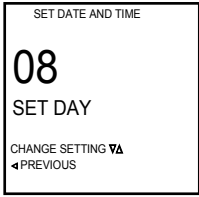

Highlighting the SET DATE AND TIME and pressing the SELECT button will bring up the set date screens then progress through the set time screens. Using the UP and DOWN arrows will change the Month, Day, Year, Hour, and Minutes. Pressing the SELECT button when the desired setting is displayed will step on to the next setting. Pressing the LEFT button will go back to the last screen viewed. Once the minutes are set and the SELECT button is pressed, the new time and date is accepted and the display returns to the MAIN MENU.

HOLD MENU

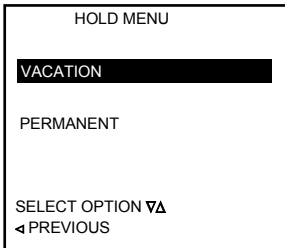

Highlighting the HOLD and pressing the SELECT button will bring up the HOLD screens. The initial hold screen asks if the hold will be a permanent hold or a Vacation hold. A permanent hold will keep the hold setting until the hold is canceled by highlighting the CANCEL HOLD on the MAIN screen and pressing the SELECT button.

VACATION HOLD

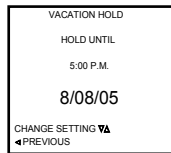
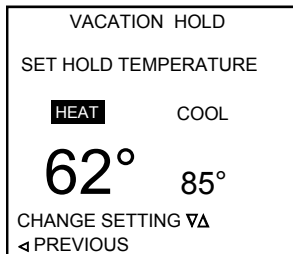

A vacation hold will ask for a time and date to release the hold automatically. Hold the UP and DOWN buttons to change the temperature setting in HEAT or COOL as appropriate and press the SELECT button to set the desired set temperature. Pressing the SELECT button will move the screen automatically to the next setting. Pressing the LEFT button will return to the last screen.

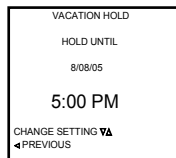

When the Temperature setting is complete, the next screen will be the TIME and DATE screen. Use the UP and DOWN buttons to select the desired date then press the SELECT button. The time set will be next. Use the UP and DOWN buttons to then select the desired time for the normal program to resume and press the SELECT button. The display will return to the MAIN MENU screen

PERMANENT HOLD

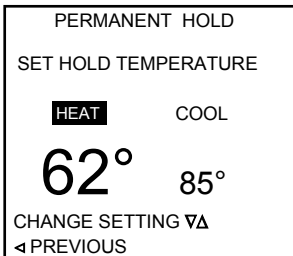

Highlighting the PERMANENT HOLD and pressing the SELECT button will bring up the PERMANENT HOLD screen. Use the UP and DOWN buttons to set the desired temperature and press the SELECT button. The display will return to the MAIN MENU screen. A Permanent hold can be reset by changing the operating mode or by highlighting the CANCEL HOLD on the MAIN screen and pressing the SELECT button.

PROGRAM MENU



Highlighting the PROGRAM selection in the MAIN MENU and pressing the select button will bring up the PROGRAM MENU.

This menu allows the thermostat to change the set temperature depending on the day and time. The days of the week can be set independently, the weekdays can all be set together, the weekends can be set together or all the days can be set the same.

PROGRAMMING SCREEN

EVERY DAY			
WAKE	HEAT	COOL	FAN
6:00A	70	78	AUTO
LEAVE			
8:00A	62	85	AUTO
RETURN			
5:00P	70	78	AUTO
SLEEP			
10:00P	62	82	AUTO
SAVE			
◀ PREVIOUS			

To program a day, highlight the day to program and press SELECT. The display will go to the PROGRAMMING SCREEN.

The programming screen will either have 4 events or 2 events to program depending on the EVENTS PER DAY setting in the SETTINGS menu.

Use the UP and DOWN buttons to select an event to program and then use the RIGHT and LEFT buttons to navigate the time and temperature. To change the event time, highlight the time and use the UP and DOWN buttons to change the value. Go to the next value to change by pressing the SELECT or the RIGHT button. Go back to the last item by pressing the LEFT button. When the desired values are set, highlight the SAVE and press the SELECT button. If you wish to copy this program to another day or to all days, highlight the COPY and press SELECT button. You will be prompted to select the day to copy from and copy to. Press the SELECT button to copy or the LEFT button to go back.

DISPLAY HUMIDITY – TSTAT0407 Model Only

HUMIDITY	
48%	
HUMIDITY	
HUMIDIFY SETTING	30
SELECT OPTION ▼▲	
◀ PREVIOUS	

Highlighting the DISPLAY HUMIDITY option and highlighting YES and pressing the SELECT button will allow the humidity to be displayed on the MAIN SCREEN.

DISPLAY DEALER INFO

BRAND NAME:	XXXXXXXXXXXXXXXXXXXXX
FURNACE MODEL NUMBER:	XXXXXXXXXXXXXXXXXXXXX
HP MODEL NUMBER:	XXXXXXXXXXXXXXXXXXXXX
CONTRACTOR NAME:	XXXXXXXXXXXXXXXXXXXXX
	260-555-5555
SERIAL NUMBER:	XXXXXXXXXXXXXXXXXXXXX
◀ PREVIOUS	SAVE ■

Highlighting the DISPLAY DEALER INFO option and pressing the SELECT button will bring up the YOUR DEALER IS screen. This is an information only screen and no options are available at this screen.

Note: Information needs to be manually input into the INPUT DEALER INPUT screen in the INSTALLER SETTINGS screen before the data can be displayed on this screen.

SETTINGS (SETTINGS MENU)

SETTINGS MENU
SCREEN SETTINGS
AUTO CHANGEOVER
INTERMITTENT FAN
SELECT OPTION ▼▲
◀ PREVIOUS

Highlighting the SETTINGS option on the MAIN MENU and pressing the SELECT button will bring up the SETTINGS MENU.

The options available on the SETTINGS MENU are:

SCREEN SETTINGS – these allow customizing the look of your screen.

AUTO CHANGE OVER – Allows the use of the AUTO mode selection or disables this function.

INTERMITTANT FAN – Runs the fan independently when the system has not run for a period of time to help equalize temperatures and mix the air.

SCREEN SETTINGS

SCREEN SETTINGS
FAHRENHEIT OR CELSIUS
12 or 24 HOUR CLOCK
LANGUAGE
CONTRAST
BACKLIGHT ON TIME
SELECT OPTION ▼▲
◀ PREVIOUS

Highlighting the SCREEN SETTINGS and pressing the SELECT button will bring up the SCREEN SETTINGS screen.

The SCREEN SETTINGS options are:

FAHRENHEIT OR CELSIUS – displays the temperature in F or C.

12 OR 24 HOUR CLOCK – displays the time in AM/PM or 24 hour style

LANGUAGE – Only English is available at this time.

CONTRAST – adjusts the darkness of the screen and characters

BACKLIGHT ON TIME – sets the time the backlight stays on after the last button push.

FAHRENHEIT OR CELSIUS

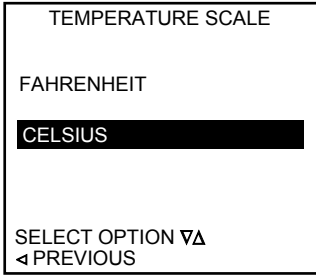

Highlighting the FAHRENHEIT OR CELSIUS option and pressing the SELECT button will bring up the FAHRENHEIT OR CELSIUS screen. Use the UP and DOWN buttons to select the option desired and press the SELECT button. The display will convert to the selected temperature scale and return to the SETTINGS MENU.

12 OR 24 HOUR CLOCK

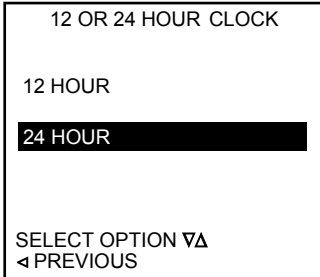

Highlighting the 12 OR 24 HOUR CLOCK option and pressing SELECT will bring up the 12 OR 24 HOUR CLOCK screen. This option will display the time in 12 hour format (5:22 PM) or in 24 hour format (17:22) Use the UP and DOWN buttons to select the desired display method and press the SELECT button to enable. The display will return to the SETTINGS menu.

LANGUAGE

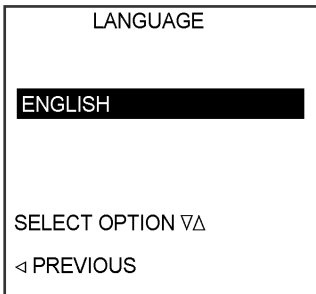

At this time ENGLISH is the only option available.

CONTRAST

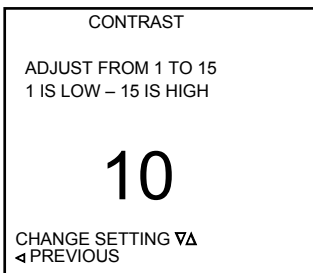

Highlighting the CONTRAST option and pressing the SELECT button will bring up the CONTRAST screen. The contrast can be changed in real time by pressing the UP and DOWN buttons. When the desired contrast is achieved, press the SELECT button and the display will return to the SETTINGS menu.

BACKLIGHT ON TIME

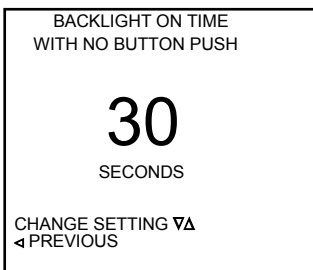

Highlighting the BACKLIGHT ON TIME option and pressing the SELECT button will bring up the BACKLIGHT ON TIME screen. Use the UP and DOWN buttons to select the desired time for the backlight to stay on after the last button was pressed. It is usually not desirable to leave the backlight on continuously because the light may generate heat that could interfere with the room temperature measurement. When the desired on time is set, Press the SELECT button and return to the SETTINGS screen. (30 – 120 seconds)

To exit this or any other screen, press the LEFT button to return to the previous screen

AUTO CHANGEOVER

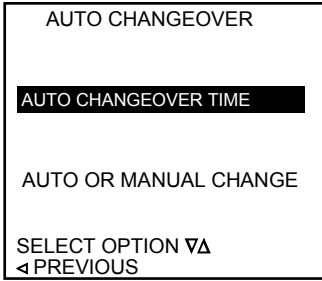

Highlighting the AUTO CHANGEOVER option and pressing the SELECT button will bring up the AUTO CHANGEOVER screen.

Auto changeover allows the thermostat to determine if Heat or Cool should be active.

The AUTO OR MANUAL option determines if the AUTO mode is available.

The AUTO CHANGEOVER TIME option sets the minimum off time necessary before switching modes.

WARNING: The COOLING LOCKOUT feature in conjunction with an outdoor sensor should be used, or a low ambient kit to protect the compressor when operating in cooling in cold weather.

AUTO CHANGEOVER TIME

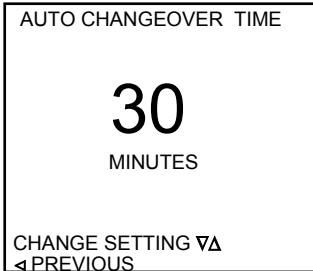

Highlighting the AUTO CHANGEOVER TIME and pressing the SELECT button brings up the AUTO CHANGEOVER TIME screen. This screen sets the minimum time the system must be idle before the automatic change of mode is allowed. For example, if the auto changeover time is set to 30 minutes and the system was cooling and the room temperature drops below the heat set point, the cooling must be idle for 30 minutes before the heating mode takes over.

The settings can be from 5 to 120 minutes in 15 minute increments.

AUTO OR MANUAL CHANGE

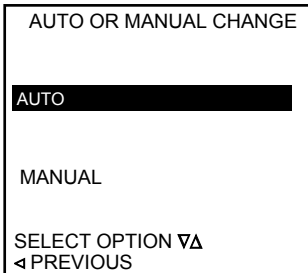

Highlighting the AUTO OR MANUAL option and pressing the SELECT button brings up the AUTO OR MANUAL CHANGE screen.

Pressing the UP or DOWN button will alternate between AUTO and MANUAL. Selecting AUTO allows the AUTO mode to be selected. Selecting MANUAL removes the AUTO mode from the MODE screen and requires manual selection of HEAT or COOL modes. Pressing the SELECT button when the desired option is highlighted enables that option.

INTERMITTENT FAN NO HEAT OR COOL CALL FAN ON TIME

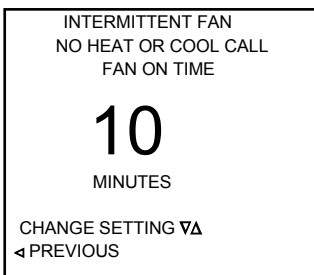

Highlighting the INTERMITTENT FAN option and pressing the SELECT button will bring up the INTERMITTENT FAN screen.

Setting the intermittent fan option will run the fan for up to 20 minutes on and up to 40 minutes off if there has been no heat or cool call for 60 minutes. The fan run time is set first. Using the UP and DOWN buttons can select a fan run time from OFF (No intermittent fan operation) to 20 minutes.

INTERMITTENT FAN NO HEAT OR COOL CALL FAN OFF TIME

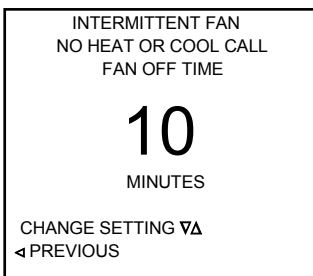

Pressing the SELECT button will bring up the next setting, the off time. This is the time the fan must be off before the intermittent fan ON time can begin. If there is no heat or cool call and the fan is not turned on manually or by the programmed setting, the fan will turn on and run for the minutes set in the FAN ON TIME screen.

Pressing the UP and DOWN button can set an OFF TIME from 5 to 40 minutes.

Pressing the SELECT button will enable the intermittent fan option and return the display to the PROGRAM SETTINGS screen.

SECURITY LOCK OUT

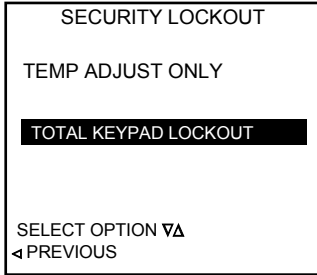

Highlighting the SECURITY LOCKOUT option from the MAIN MENU and pressing the SELECT button will bring up the SECURITY LOCKOUT screen. Activating the security lock out and setting a 4 digit PIN will prevent unauthorized changes to the thermostat. The lockout can be total, no functions are allowed without entering the PIN or partial that allows setting of a temporary hold to override the set temperature. To lockout the thermostat totally, highlight TOTAL KEYPAD LOCKOUT and press the SELECT button. To allow temporary override of the programmed temperatures or a change of set temperature in nonprogrammable systems, highlight the TEMP ADJUST ONLY and press the SELECT button.

The ENTER PIN NUMBER screen will appear.

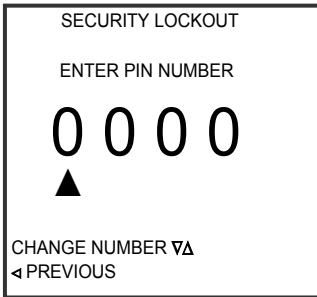

Use the UP and DOWN buttons to change the highlighted PIN digit until the desired number is displayed. Press the SELECT button and the display will highlight the next digit. Be sure to choose a PIN that you will remember. When the last digit is selected, the screen will return to the MAIN SCREEN and attempts to change settings will flash the message LOCKED and bring up the UNLOCK SCREEN. Enter the PIN into the unlock screen to unlock and allow changes to the thermostat. Once the thermostat is unlocked, it is necessary to reset the PIN number to relock the thermostat.

NOTE: A PIN number of 9999 will always unlock the thermostat.

FACTORY DEFAULTS		
OPTION	DEFAULT SETTING	RANGE
Set Temperature	70	55 - 95
Display F or C	F	F or C
Auto Daylight Savings Time	ON	ON or OFF
12 or 24 Hour Clock	12	12 or 24
Allow AUTO MODE	ON	ON or OFF
Temporary HOLD	OFF	ON or OFF
Vacation Hold	OFF	ON or OFF
Permanent HOLD	OFF	ON or OFF
Operating Mode	OFF	OFF, HEAT, COOL, EHEAT, AUTO
EVENTS PER DAY	4	2 OR 4
TEMPERATURE OFFSET	0	-5 TO +5
REMOTE TEMPERATURE OFFSET	0	-5 TO +5
OUTDOOR TEMPERATURE OFFSET	0	-5 TO +5
HUMIDITY OFFSET	0	-10 TO +10%
ANTICIPATOR	3	1 TO 9
NO COOLING BELOW OUTDOOR TEMPERATURE	NONE	OFF- 45 - 55
NO ELECTRIC HEAT ABOVE OUTDOOR TEMPERATURE	NONE	NONE - 5 - 60
SMART RECOVERY	OFF	ON - OFF
FAN OPERATING MODE	AUTO	AUTO - ON - PROGRAMMED
BACKLIGHT ON TIME	30 SEC	15 TO ON
CYCLES PER HOUR	4	4 OR 6
AUTO CHANGEOVER TIME	15 min.	5 TO 120
HUMIDITY SET POINT	40	10 - 50%
DEHUMIDIFY SET POINT	60	40 - 90%
HUMIDITY OPTIONS	NONE	HUMIDIFY, DEHUMIDIFY, AUTO, NONE
SMART HEAT STAGE TIME	30 min	OFF to 120 min.
SMART STAGING	ON	ON - OFF
INTERMITTENT FAN ON TIME	OFF	OFF TO 20
INTERMITTENT FAN OFF TIME	40	5 TO 40
LOCK SCREEN	OFF	OFF, ALL, ALLOW TEMPERATURE CHANGE
AIR FILTER ALARM	MONTHS	MONTHS OR HOURS
AIR FILTER ALARM MONTHS	6	OFF TO 48 months
AIR FILTER ALARM HOURS	1000	OFF to 3600
HUMIDIFIER ALARM	MONTHS	MONTHS OR HOURS
HUMIDIFIER ALARM MONTHS	OFF	OFF TO 48 MONTHS
HUMIDIFIER ALARM HOURS	OFF	OFF TO 3600 hours
UV LAMP ALARM	MONTHS	MONTHS OR HOURS
UV LAMP ALARM MONTHS	OFF	OFF TO 48 months
UV LAMP ALARM HOURS	OFF	OFF TO 3600
SERVICE AIR CLEANER ALARM	MONTHS	MONTHS OR HOURS
SERVICE AIR CLEANER ALARM MONTHS	OFF	OFF TO 48 months
SERVICE AIR CLEANER ALARM HOURS	OFF	OFF TO 3600 hours
HEAT PUMP		
BALANCE POINT	OFF	OFF - 5 TO 55
CONTRAST	4	1 to 10
DEALER NAME	Blank	Up to 20 characters
DEALER PHONE	Blank	10 numbers
MODEL NUMBER	Blank	Up to 20 characters
BRAND NAME	Blank	Up to 20 characters
DOWN STAGING	ON	ON or OFF
COOL TO DEHUMIDIFY	YES	YES or NO

Default Set Back Program

ALL DAYS

	WAKE	HEAT	COOL	FAN
6:00AM		70	78	AUTO
LEAVE				
8:00 AM		62	85	AUTO
RETURN				
5:00 PM		70	78	AUTO
SLEEP				
10:00 PM		62	82	AUTO

OUTDOOR / INDOOR SENSOR INFORMATION

Refer to the Outdoor Sensor literature for details.

The literature is included within the sensor packet with the thermostat.

NOTE: The outdoor can be used as an indoor sensor and connected to the ID and GND terminals on the back of the thermostat. When an indoor sensor is used, it overrides the thermostat's onboard sensor.

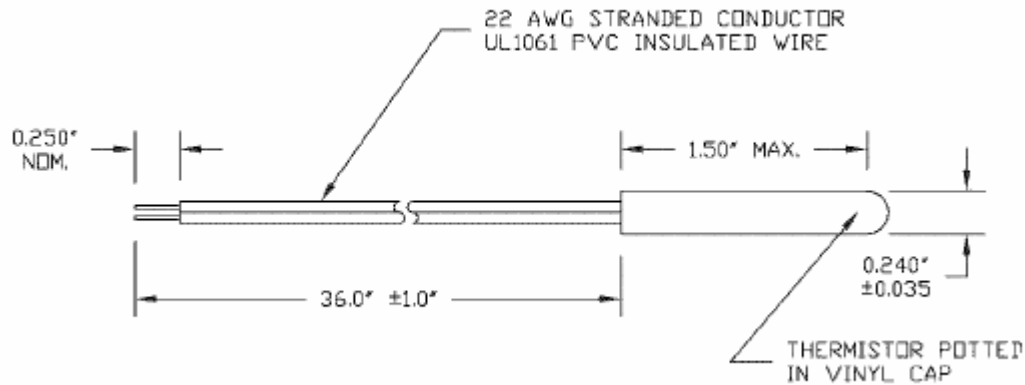

TEMP (F°)	Rnominal (Ω)	RES. TOL ±%	Rmin. (Ω)	Rmax. (Ω)	TEMP. COEF. (%/°F)	TEMP. ACCY. (±°F)
40	344711	11.21	306069	383353	3.74	3.00
31	247768	10.83	220935	274601	3.61	3.00
22	180147	10.44	161340	198955	3.48	3.00
13	132410	10.06	119063	145757	3.36	3.00
4	98324	6.50	91933	104716	3.25	2.00
5	73724	6.30	69079	78368	3.15	2.00
14	55787	6.10	52384	59190	3.05	2.00
23	42583	5.92	40062	45104	2.96	2.00
32	32773	2.85	31839	33707	2.85	1.00
41	25456	2.76	24753	26158	2.76	1.00
50	19932	2.68	19397	20466	2.68	1.00
59	15725	2.59	15318	16133	2.59	1.00
68	12497	2.51	12183	12811	2.51	1.00
77	10000	2.44	9756	10244	2.44	1.00
86	8055	2.37	8764	8246	2.37	1.00
95	6528	2.30	6378	6679	2.30	1.00
104	5323	4.48	5085	5562	2.24	2.00
113	4365	4.34	4176	4554	2.17	2.00
122	3599	4.22	3447	3751	2.11	2.00
131	2983	6.16	2800	3167	2.05	3.00
140	2486	5.99	2337	2635	2.00	3.00
149	2082	5.83	1961	2204	1.94	3.00
158	1753	5.67	1653	1852	1.89	3.00
167	1482	7.36	1373	1591	1.84	4.00
176	1258	7.17	1168	1349	1.79	4.00
185	1073	8.73	979.4	1167	1.75	5.00
194	918.9	8.51	840.7	997.1	1.70	5.00
203	789.9	9.96	711.3	868.6	1.66	6.00
212	681.6	9.68	615.6	747.6	1.61	6.00

NAXA00101DB DAUGHTER BOARD

The NAXA00101DB daughter board control allows for using 4 existing thermostat wires in an existing, finished home to communicate with the TSTAT0406 & TSTAT0407 thermostats. The daughter board translates the communicated heating and cooling needs and sends the normal discrete thermostat outputs to the indoor and outdoor equipment as needed. The NAXA00101DB Daughter Board must be used in conjunction with the TSTAT0406 or TSTAT0407 Communicating Thermostat for proper operation. The daughter board provides a two-wire RS485 ModBus communication link and 24VAC to the communicating thermostat via a 4 wire connection scheme, "L" input from the Comfort Alert Module, a sensor input for the remote outdoor sensor, seven thermostat 24VAC outputs (W,G,Y,O,W2,Y2,H) and status & communication LED's.

NAXA00101 Daughter Board Kit includes the following:

- NAXA00101DB Daughter Board
- 4 - # 6 Mounting Screws
- "L" Input Pigtail Wire Harness & wire nut
- Remote Outdoor Sensor Pigtail Wire Harness & wire nuts
- Installation Instructions

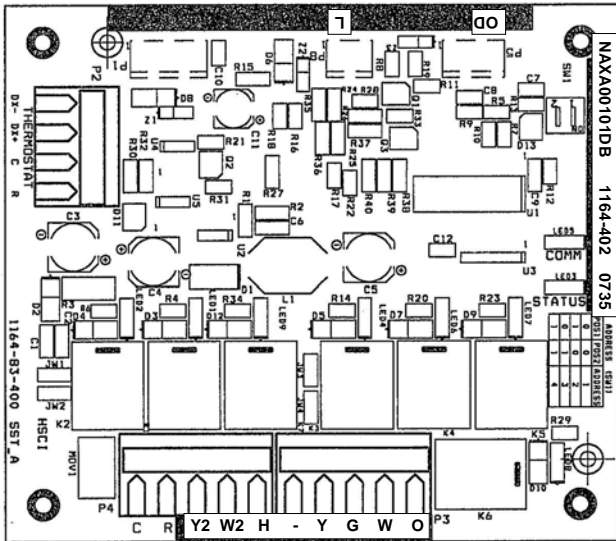

Daughter Board Terminals & Connections

See wiring diagrams for proper wiring and installation.

The following connections are provided in the P2 terminal block: (Power and Communication Connections to Communicating Thermostat)

P2 - Pin 1	"R"	24VAC hot power connection for communicating thermostat
P2 - Pin 2	"GND"	Ground connection for communicating thermostat
P2 - Pin 3	"DX+"	DX+ connection to the A+ Terminal on the communicating thermostat
P2 - Pin 4	"DX-"	DX- connection to the B- Terminal on the communicating thermostat

The following connections are provided in the P3 terminal block: (Outputs to the HVAC Equipment)

P3 - Pin 1	"O"	24 VAC thermostat output
P3 - Pin 2	"W"	24 VAC thermostat output
P3 - Pin 3	"G"	24 VAC thermostat output
P3 - Pin 4	"Y"	24 VAC thermostat output
P3 - Pin 5	"Not Used"	24 VAC thermostat output

The following connections are provided in the P4 terminal block: (Outputs to the HVAC Equipment)

P4 - Pin 1	"H"	24 VAC thermostat output
P4 - Pin 2	"W2"	24 VAC thermostat output
P4 - Pin 3	"Y2"	24 VAC thermostat output
P4 - Pin 4	"R"	24 VAC system power input
P4 - Pin 5	"C"	24 VAC system common input

The following connections are provided in the P5 Connector: (Optional Location for the Outdoor Sensor Hook-up)

P5 - Pin 1	"OD"	Ground for Remote Outdoor Temperature Sensor
P5 - Pin 2	"OD"	Remote Outdoor Temperature Sensor input
P5 - Pin 3	"Not used"	
P5 - Pin 4	"Not used"	

The following connections are provided in the P8 Connector: (Optional Connection for the Comfort Alert ALARM Output)

P8 - Pin 1	"Not Used"	---- No Connect----
P8 - Pin 2	"Not Used"	- - - No connect - - -
P8 - Pin 3	"L"	"L" fault input from Comfort Alert Module

Status LED Operation

The LED labeled LED5 is a status LED that will provide a “heart beat” blink of this LED to indicate that the NAXA00101DB communicating daughter board control is powered and working properly.

Communication LED Operation

The LED labeled LED3 will be illuminated for 100mS each time a successful communications packet is received from the TSTAT0406 or TSTAT0407 communicating thermostat.

Thermostat Call Output LED’s Operation

There is an LED Output for each thermostat output from the daughter board. The corresponding LED will illuminate any time the associated thermostat output is active.

“L” Input from Comfort Alert Module to Daughter Board

The Comfort Alert Module will transmit the active fault code. The Comfort Alert or thermostat does not have any effect on operation of the equipment during a Comfort Alert fault. The Comfort Alert fault output can be wired directly to the daughter board or communicating thermostat. When the Comfort Alert Module is wired to the “L” input of the daughter board, it will recognize the fault output after it has been active for 10 seconds. After the daughter board has recognized the active fault from the Comfort Alert Module, the daughter board will forward the fault information to the communicating thermostats via the communication wires. The communicating thermostat will then display the fault code as defined.

GENERIC AC TO FANCOIL WIRING (REFER TO UNITS I/O MANUAL FOR SPECIFICS)

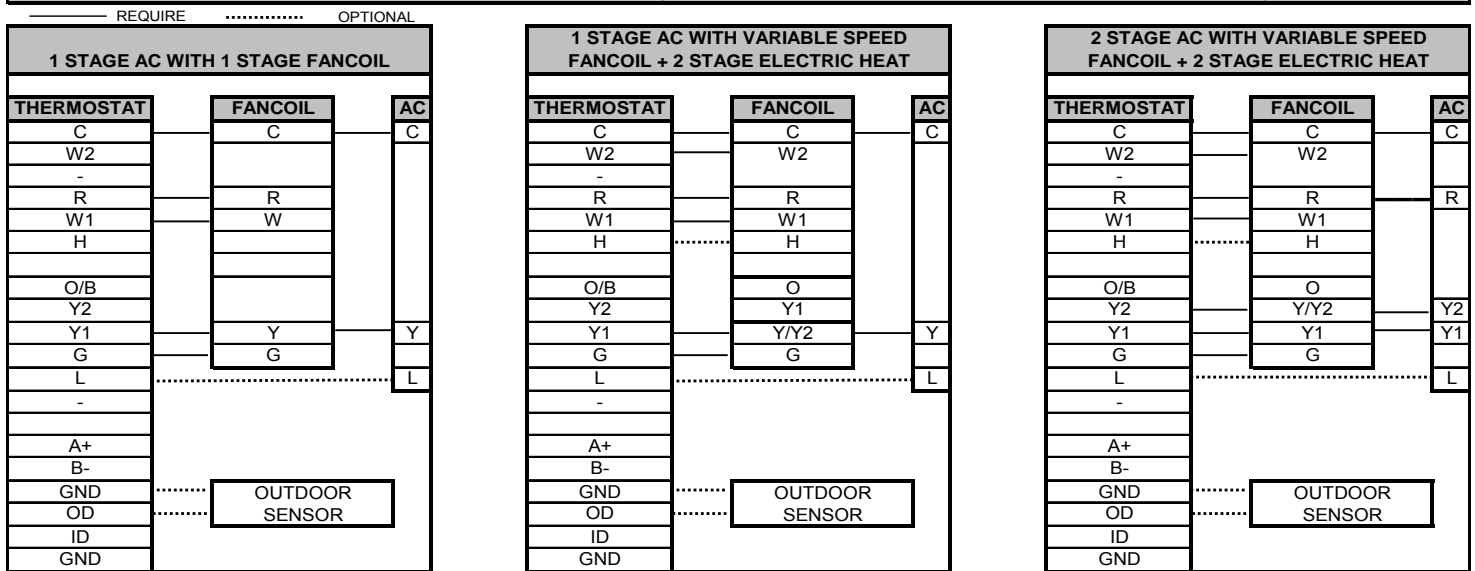

GENERIC HP TO FANCOIL WIRING (REFER TO UNITS I/O MANUAL FOR SPECIFICS)

———— REQUIRE OPTIONAL
 NOTES: H ON THERMOSTAT - CAN BE PROGRAMMED FOR HUM OR DEHUM FUNCTION. DEHUM MUST BE SELECTED WHEN CONNECTED TO DEHUM ON VARIABLE SPEED FANCOIL.

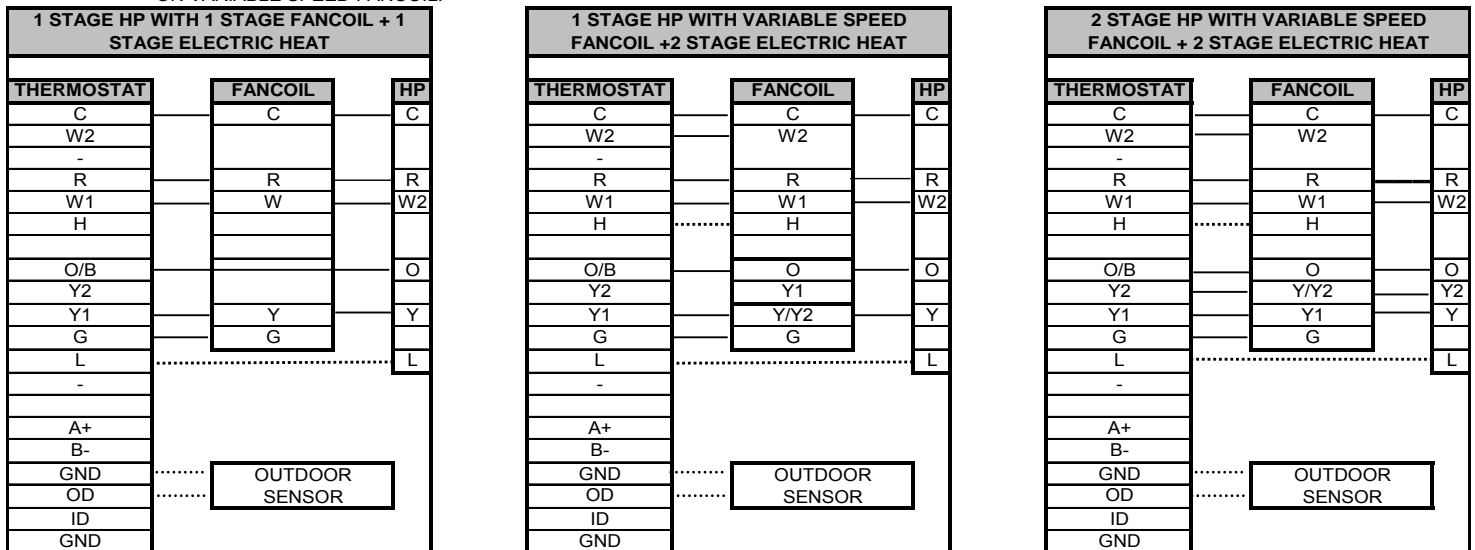

NOTE: “L” wire can be terminated at either the thermostat OR the daughter board.

GENERIC AC TO FURNACE WIRING (REFER TO UNITS I/O MANUAL FOR SPECIFICS)

----- REQUIRED OPTIONAL
 NOTES: 24 VAC HUM - GOES TO HUMIDIFIER, ENERGIZES ON A CALL FOR W

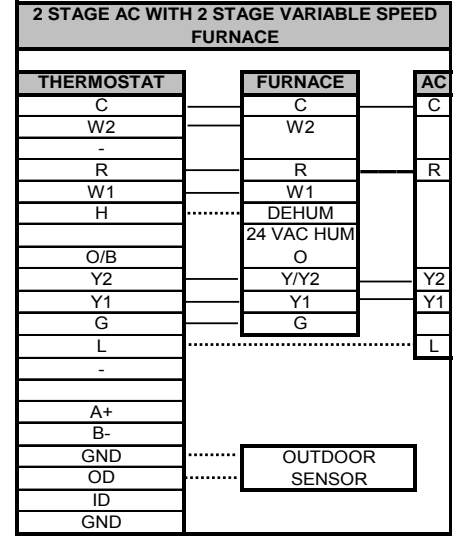
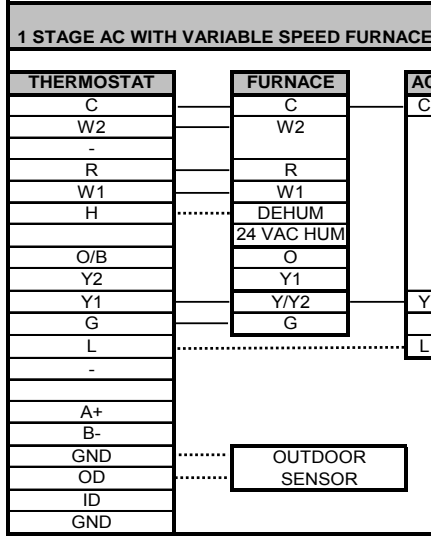
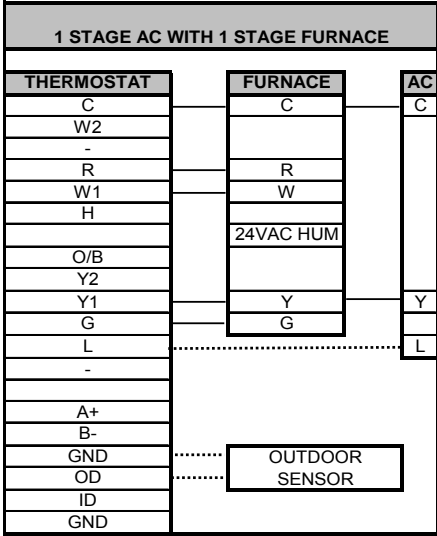

8MPV "C" SERIES OR NEWER
 9MPV "D" SERIES OR NEWER

8MPV "C" SERIES OR NEWER
 9MPV "D" SERIES OR NEWER

GENERIC HP TO FURNACE WIRING (REFER TO UNITS I/O MANUAL FOR SPECIFICS)

----- REQUIRED OPTIONAL
 NOTES: 24 VAC HUM - GOES TO HUMIDIFIER, ENERGIZES ON A CALL FOR W
 H - CAN BE PROGRAMMED FOR HUM OR DEHUM FUNCTION. DEHUM MUST BE SELECTED WHEN CONNECTED TO DEHUM ON VARIABLE SPEED FURNACE.

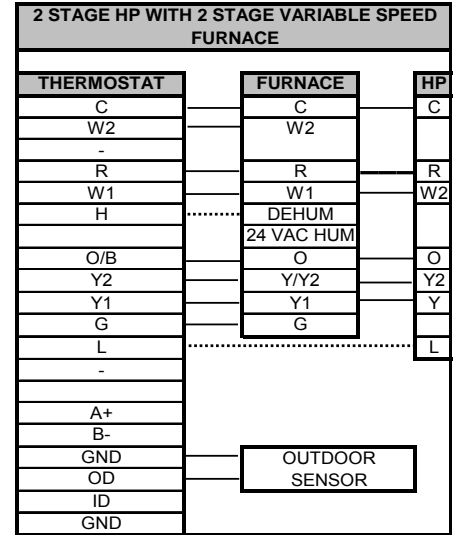
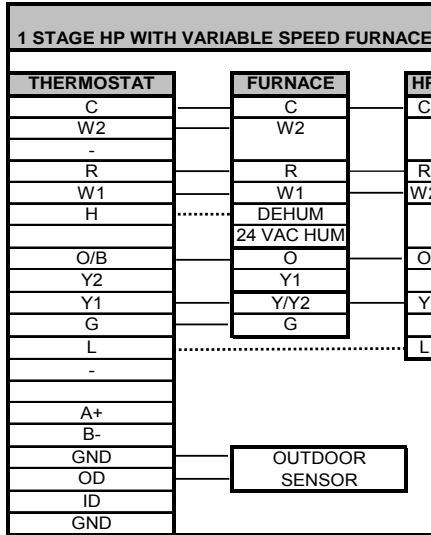
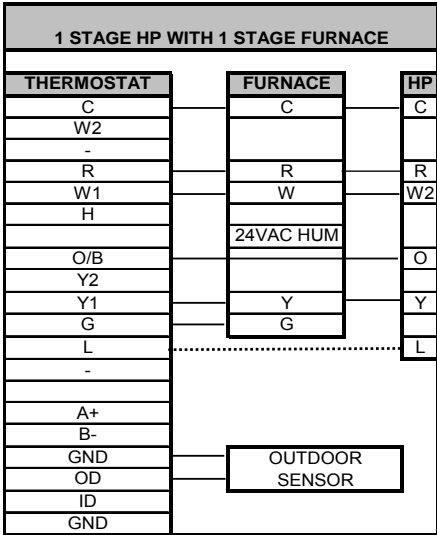

8MPV "C" SERIES OR NEWER
 9MPV "D" SERIES OR NEWER

8MPV "C" SERIES OR NEWER
 9MPV "D" SERIES OR NEWER

----- = VARIABLE SPEED (DEHUM) ——— = REQUIRED

