

PGF SERIES

7-1/2 Ton

Belt Drive TEMPSTAR®

Heating and Cooling Products

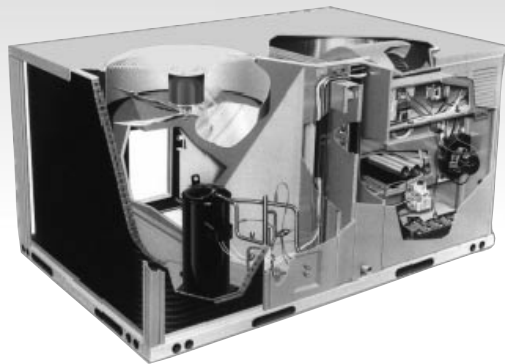

CONVERTIBLE SINGLE PACKAGE GAS/ELECTRIC UNIT

SINGLE PACKAGE

- Combination gas heating and electric cooling, self contained for year-round comfort. Systems can be installed on rooftop or ground level with the new convertible design.

CABINET

- Triple-coated steel, consisting of a Polyester top coat, a urethane primer coat preceded by an oxide pretreatment. Access panels for easy service. Side by side supply and return. Heavy gauge base with rails.

INTEGRAL BASE RAILS

- Fork-lift access on three sides. Holes provided for lifting lugs makes rooftop installation easier.

IMPROVED INSULATION

- Dual density insulation improves temperature separation.

INDOOR BLOWER

- Electronic Fan Control, continuous fan feature responds quickly to circulate heated air and provide maximum comfort.
- Standard belt drive blower.
- "No Difference" Design - Unit will operate at the same rated External Static Pressure in the down shot or horizontal duct position.

INTERNAL AIR FILTERS

- Easy access air filters to maintain a clean evaporator coil.

COPPER TUBE/ALUMINUM FIN COILS

- Enhanced aluminum fins mechanically bonded to 3/8" copper tubes for improved heat transfer.

COMPRESSORS

- Scroll compressor.

HIGH & LOW PRESSURE SWITCHES

- To provide excellent compressor protection.

FREEZE THERMOSTAT

- Mounted to evaporator, prevents coil freeze up.

EXTERNALLY-MOUNTED GAUGE PORTS

- Allows for more accurate reading of operating conditions while servicing.

INDUCED DRAFT COMBUSTION SYSTEM

- For smoother combustion and optimal efficiency.

ALUMINIZED TUBULAR HEAT EXCHANGER

- Tubular design delivers efficient heat transfer and air flow: aluminized coating protects against corrosion.

IGNITION SYSTEM

- Honeywell Electronic Hot Surface/Pilot (HSP) Ignition system.

IN-SHOT BURNERS

- New design delivers more complete, efficient combustion.

PRE-WIRED FOR ECONOMIZER

- Designed for slide in, plug in economizer installation.

65VA TRANSFORMER

- Standard 65 VA transformer has built-in secondary circuit breaker standard on all models.

WARRANTY

- Standard one (1) year limited warranty on parts.
- Five (5) year limited warranty on the compressor.

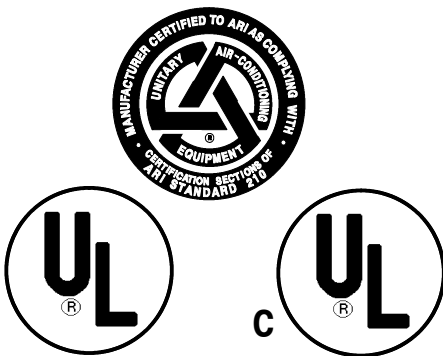

RESIDENTIAL AND COMMERCIAL SYSTEMS • SPLIT SYSTEMS • PACKAGED AIR CONDITIONERS
• COMBINATION GAS / ELECTRIC UNITS • HEAT PUMPS • AIR HANDLERS • MANUFACTURED
HOME AIR CONDITIONERS • GAS, OIL AND ELECTRIC FURNACES

International Comfort Products
650 Heil-Quaker Avenue, Lewisburg, TN 37091

509 21 1501 02

2/03

UNIT SPECIFICATIONS

MODEL NUMBER	Electrical Data				Compressor Data		Factory Charge R-22 Oz.	Ship. Weight Lbs.
	Voltage Phase - Hz	Max. Fuse	Min. Fuse	Min. Circuit Ampacity	RLA	Locked Rotor Amps		
PGF090H16A	208/230-3-60	70	60	45	28.85	195.0	212	752
PGF090L16A	460-3-60	35	30	22.9	14.74	95.0	212	752
PGF090S16A	575-3-60	25	20	17.2	10.77	80.0	212	752

MODEL NUMBER	Condenser Data								
	Coil			Fan Motor			Fan - 4 Blade		
	Total Face Area Sq. Feet	Fins Per In. / Rows	Tube Diameter In.	Horse-power	FLA /LRA	RPM (Max.)	Size Diameter In.	Degree Pitch	CFM (Max.)
PGF090H16A	16.48	20 / 2.7	3/8	.75	2.9 / 9.5	1140	22	28	4500
PGF090L16A	16.48	20 / 2.7	3/8	.75	1.5 / 5.0	1140	22	28	4500
PGF090S16A	16.48	20 / 2.7	3/8	.75	1.3 / 3.9	1140	22	28	4500

MODEL NUMBER	Evaporator Coil Data								
	Coil			Blower		Motor		Blower	
	Total Face Area Sq. Feet	Fins Per In. / Rows	Tube Diameter In.	Blower H.P. - Speeds	FLA / LRA	RPM	Type & Size	RPM (Max)	CFM Rated
PGF090H16A	8.24	14 / 4	3/8	2.0	6.0 / 49.6	1725	BD12-12A	1400	3000
PGF090L16A	8.24	14 / 4	3/8	2.0	3.0 / 24.9	1725	BD12-12A	1400	3000
PGF090S16A	8.24	14 / 4	3/8	2.0	2.4 / 16.3	1725	BD12-12A	1400	3000

PERFORMANCE DATA: HEATING

MODEL NUMBER	Input (MBTUH)	Output (MBTUH)	Efficiency	Temperature Rise ° F (° C)
	Standard	Standard	DOE (AFUE)	
			Std.	
PGF090	160	130	81.0	30 - 60(1.67 - 18.3)

PERFORMANCE DATA: COOLING

MODEL NUMBER	Rated Capacity BTUH*	S / T Ratio	E.E.R.	Evaporator Rated Airflow (SCFM)
PGF090	91,000	.74	9.00	3000

*NOTES: Rated Capacity @ ARI Standards 95° Amb, 80° DB, / 67° WB, 230 Volts. For applications at 208 volts deduct 1000 BTU.

MODEL NUMBER IDENTIFICATION GUIDE

MODEL NUMBER	P	G	F	090	H	16	A
Product Family P = Single Package							Sales Code
Fuel Type G = Gas / Electric							Gas Heat Input 16 = 160,000 Btu
Design Series							
Capacity (Nominal BTU) 090 = 7-1/2 Ton							Voltage / Phase / Hertz H = 208/230/3/60 L = 460/3/60 S = 575/3/60

WEIGHTS AND CENTER OF GRAVITY

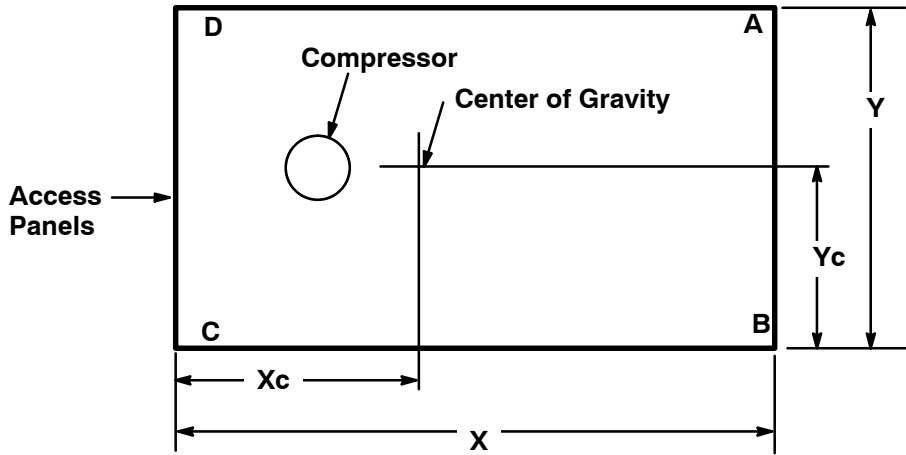

Center of Gravity Location (Inches)				
Unit Size	X	Y	Xc	Yc
7-1/2 Ton	73	47-3/8	35-3/4	21-1/4

Total and Corner Weight (lbs) (Operating Weight)					
Unit Size	A	B	C	D	Total
7-1/2 Ton	164	201	210	170	745

UNIT DIMENSIONS

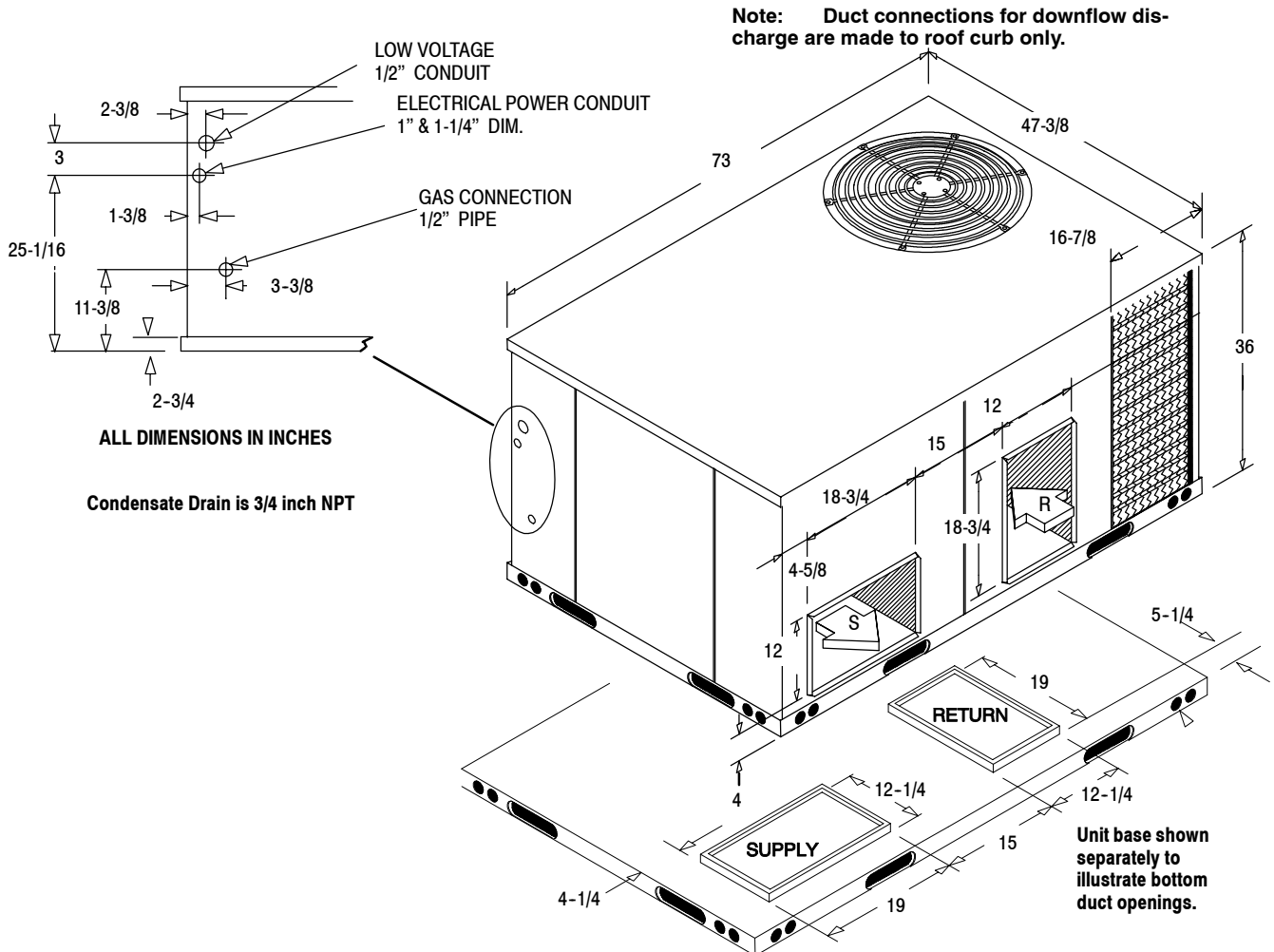

EXPANDED PERFORMANCE DATA (COOLING) - 7-1/2 Ton (Gross Capacity)

Airflow IDB* CFM			Outdoor Ambient Temperature - Degrees F. Dry Bulb																							
			65				75				85				95				105				115			
			Entering Indoor Temperature - Degrees F. Wet Bulb																							
			59	63	67	71	59	63	67	71	59	63	67	71	59	63	67	71	59	63	67	71	59	63	67	71
70	3360	MBh	93.8	97.2	106.5	-	91.6	94.9	104.0	-	89.4	92.7	101.5	-	87.2	90.4	99.1	-	82.9	85.9	94.1	-	76.8	79.6	87.2	-
		S/T	0.74	0.62	0.43	-	0.77	0.64	0.45	-	0.79	0.66	0.46	-	0.82	0.68	0.47	-	0.85	0.71	0.49	-	0.85	0.71	0.49	-
		KW	6.62	6.77	7.01	-	7.19	7.36	7.63	-	7.70	7.88	8.17	-	8.14	8.34	8.65	-	8.52	8.73	9.05	-	8.85	9.07	9.40	-
	3000	MBh	91.0	94.4	103.4	-	88.9	92.2	101.0	-	86.8	90.0	98.6	-	84.7	87.8	96.2	-	80.5	83.4	91.4	-	74.5	77.2	84.6	-
		S/T	0.71	0.59	0.41	-	0.73	0.61	0.43	-	0.75	0.63	0.44	-	0.78	0.65	0.45	-	0.81	0.67	0.47	-	0.81	0.68	0.47	-
		KW	6.56	6.71	6.95	-	7.13	7.30	7.56	-	7.63	7.81	8.09	-	8.07	8.27	8.57	-	8.45	8.65	8.97	-	8.77	8.99	9.32	-
2640	MBh	86.5	89.6	98.2	-	84.5	87.6	95.9	-	82.5	85.5	93.7	-	80.5	83.4	91.4	-	76.4	79.2	86.8	-	70.8	73.4	80.4	-	
	S/T	0.68	0.57	0.39	-	0.70	0.59	0.41	-	0.72	0.60	0.42	-	0.74	0.62	0.43	-	0.77	0.65	0.45	-	0.78	0.65	0.45	-	
	KW	6.44	6.59	6.83	-	7.00	7.17	7.42	-	7.49	7.67	7.95	-	7.92	8.12	8.41	-	8.29	8.50	8.80	-	8.61	8.82	9.14	-	
75	3360	MBh	95.4	98.2	106.3	114.1	93.1	95.9	103.8	111.4	90.9	93.6	101.3	108.8	88.7	91.3	98.9	106.1	84.3	86.8	93.9	100.8	78.1	80.4	87.0	93.4
		S/T	0.84	0.76	0.57	0.37	0.88	0.78	0.59	0.38	0.90	0.80	0.61	0.39	0.93	0.83	0.63	0.40	0.96	0.86	0.65	0.42	0.97	0.87	0.66	0.42
		KW	6.68	6.84	7.08	7.33	7.26	7.43	7.70	7.98	7.77	7.96	8.24	8.55	8.22	8.42	8.73	9.05	8.60	8.82	9.14	9.48	8.94	9.16	9.49	9.84
	3000	MBh	92.6	95.3	103.2	110.7	90.4	93.1	100.8	108.2	88.3	90.9	98.4	105.6	86.1	88.7	96.0	103.0	81.8	84.2	91.2	97.9	75.8	78.0	84.5	90.7
		S/T	0.81	0.72	0.55	0.35	0.84	0.75	0.57	0.36	0.86	0.77	0.58	0.37	0.88	0.79	0.60	0.38	0.92	0.82	0.62	0.40	0.93	0.83	0.63	0.40
		KW	6.62	6.78	7.02	7.27	7.19	7.37	7.63	7.91	7.70	7.89	8.17	8.47	8.15	8.35	8.65	8.97	8.53	8.74	9.05	9.39	8.85	9.07	9.40	9.75
2640	MBh	88.0	90.6	98.0	105.2	85.9	88.5	95.7	102.8	83.9	86.4	93.5	100.3	81.8	84.2	91.2	97.9	77.7	80.0	86.6	93.0	72.0	74.1	80.2	86.1	
	S/T	0.77	0.69	0.52	0.34	0.80	0.72	0.54	0.35	0.82	0.73	0.56	0.36	0.85	0.76	0.57	0.37	0.88	0.79	0.59	0.38	0.89	0.79	0.60	0.39	
	KW	6.50	6.65	6.89	7.14	7.06	7.23	7.49	7.76	7.56	7.74	8.02	8.31	8.00	8.19	8.49	8.80	8.37	8.57	8.89	9.21	8.69	8.90	9.23	9.57	
80	3360	MBh	97.1	99.2	106.0	113.3	94.8	96.9	103.5	110.6	92.5	94.6	101.0	108.0	90.3	92.3	98.6	105.4	85.8	87.6	93.6	100.1	79.5	81.2	86.7	92.7
		S/T	0.93	0.87	0.71	0.53	0.96	0.90	0.73	0.55	1.00	0.92	0.75	0.56	1.00	0.95	0.78	0.58	1.00	1.00	0.81	0.60	1.00	1.00	0.81	0.61
		KW	6.74	6.90	7.14	7.40	7.32	7.50	7.77	8.05	7.84	8.03	8.32	8.63	8.30	8.50	8.81	9.13	8.68	8.90	9.22	9.56	9.02	9.24	9.58	9.94
	3000	MBh	94.2	96.3	102.9	110.0	92.0	94.1	100.5	107.4	89.9	91.8	98.1	104.9	87.7	89.6	95.7	102.3	83.3	85.1	90.9	97.2	77.1	78.8	84.2	90.0
		S/T	0.88	0.83	0.67	0.50	0.92	0.86	0.70	0.52	0.94	0.88	0.72	0.54	0.97	0.91	0.74	0.55	1.00	0.94	0.77	0.57	1.00	0.95	0.77	0.58
		KW	6.68	6.84	7.08	7.34	7.26	7.43	7.70	7.98	7.77	7.96	8.25	8.55	8.22	8.42	8.73	9.05	8.61	8.82	9.14	9.48	8.94	9.16	9.49	9.84
2640	MBh	89.5	91.5	97.7	104.5	87.4	89.4	95.5	102.0	85.4	87.2	93.2	99.6	83.3	85.1	90.9	97.2	79.1	80.8	86.4	92.3	73.3	74.9	80.0	85.5	
	S/T	0.85	0.79	0.65	0.48	0.88	0.82	0.67	0.50	0.90	0.84	0.69	0.51	0.93	0.87	0.71	0.53	0.96	0.90	0.74	0.55	0.97	0.91	0.74	0.55	
	KW	6.56	6.71	6.95	7.20	7.13	7.30	7.56	7.83	7.63	7.81	8.09	8.39	8.07	8.27	8.57	8.88	8.45	8.65	8.97	9.30	8.77	8.99	9.32	9.66	
85	3360	MBh	98.8	100.7	105.4	112.5	96.5	98.3	103.0	109.9	94.2	96.0	100.5	107.3	91.9	93.6	98.1	104.6	87.3	89.0	93.2	99.4	80.8	82.4	86.3	92.1
		S/T	0.97	0.94	0.85	0.69	1.00	0.97	0.88	0.71	1.00	1.00	0.90	0.73	1.00	1.00	0.93	0.75	1.00	1.00	0.96	0.78	1.00	1.00	0.97	0.79
		KW	6.80	6.96	7.21	7.47	7.39	7.57	7.84	8.13	7.91	8.10	8.40	8.71	8.37	8.58	8.89	9.22	8.76	8.98	9.31	9.65	9.10	9.33	9.67	10.03
	3000	MBh	95.9	97.7	102.4	109.2	93.7	95.5	100.0	106.7	91.4	93.2	97.6	104.1	89.2	90.9	95.2	101.6	84.7	86.4	90.5	96.5	78.5	80.0	83.8	89.4
		S/T	0.93	0.89	0.81	0.65	0.96	0.93	0.84	0.68	0.98	0.95	0.86	0.70	1.00	0.98	0.89	0.72	1.00	1.00	0.92	0.75	1.00	1.00	0.93	0.75
		KW	6.74	6.90	7.14	7.40	7.32	7.50	7.77	8.05	7.84	8.03	8.32	8.63	8.30	8.50	8.81	9.13	8.68	8.90	9.22	9.56	9.02	9.24	9.58	9.94
2640	MBh	91.1	92.9	97.2	103.7	89.0	90.7	95.0	101.3	86.9	88.5	92.7	98.9	84.7	86.4	90.5	96.5	80.5	82.1	85.9	91.7	74.6	76.0	79.6	84.9	
	S/T	0.89	0.86	0.77	0.63	0.92	0.89	0.80	0.65	0.94	0.91	0.82	0.67	0.97	0.94	0.85	0.69	1.00	0.97	0.88	0.71	1.00	0.98	0.89	0.72	
	KW	6.62	6.77	7.01	7.27	7.19	7.36	7.63	7.90	7.70	7.88	8.17	8.47	8.14	8.34	8.65	8.96	8.52	8.73	9.05	9.39	8.85	9.07	9.40	9.75	

* Entering Indoor Temperature - Degrees F. Dry Bulb

BELT DRIVE BLOWER PERFORMANCE DATA - 7-1/2 TON UNIT

230, 460, 575 VOLT

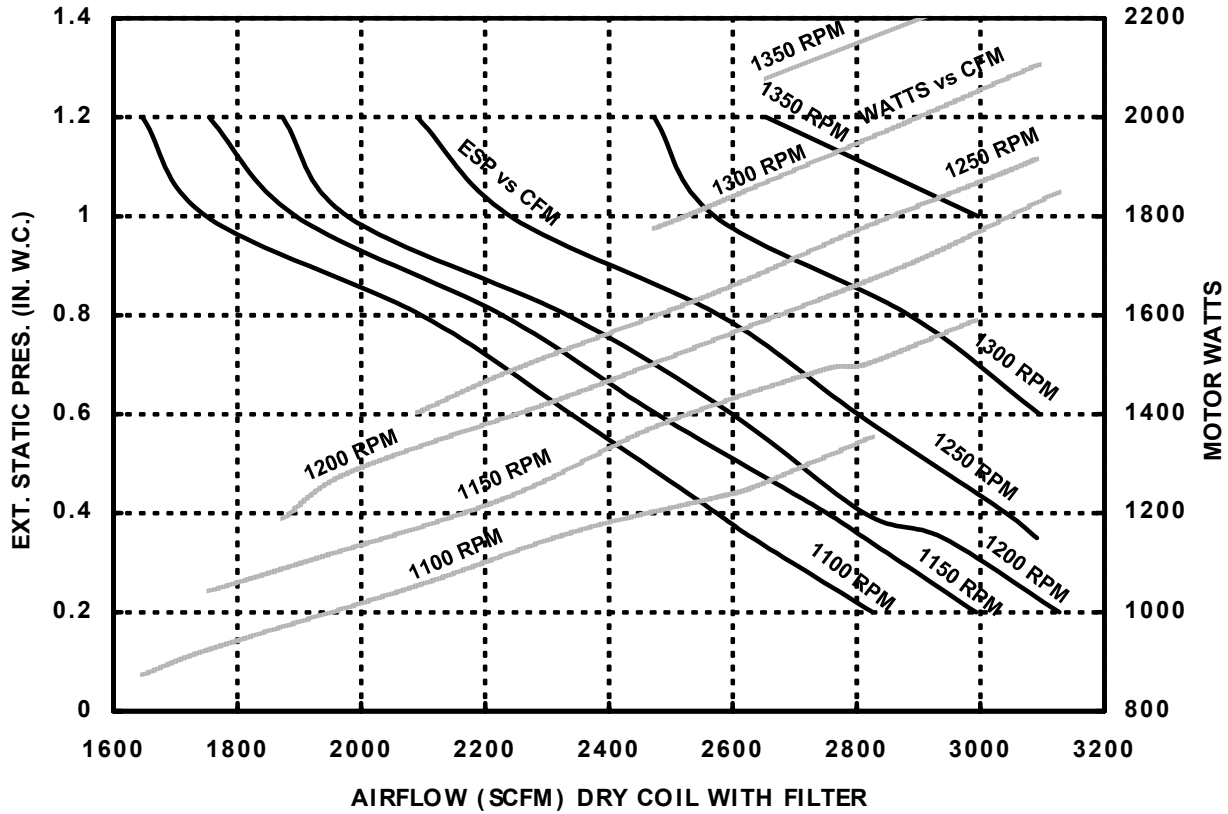

NOTES: 1) Maximum motor Watts is 2158 Watts at 208V, and 2246 Watts at 230-460-575V. 2) Maximum blower speed is 1400 RPM. 3) Contact factory for applications requiring operation outside standard cooling operating range. 4) Airflow data is based on dry coil with filters. 5) Pulley turns refers to turns out. In other words, 0 turns is a narrower sheave than 5 turns. 6) Blower speed MUST be set to give the correct air temperature rise through the unit as marked on the Rating Plate. 7) Add 0.05 in. ESP for 208 volt operation.

VOLTS	TURNS OPEN	EXTERNAL STATIC PRESSURE IN INCHES WATER COLUMN																	
		.2			.4			.6			.8			1.0			1.2		
		CFM	WATTS	RPM	CFM	WATTS	RPM	CFM	WATTS	RPM	CFM	WATTS	RPM	CFM	WATTS	RPM	CFM	WATTS	RPM
230 / 460/ 575	0													2996	2246	1345	2654	2077	1355
	1							3095	2107	1295	2885	1992	1297	2571	1825	1300	2473	1775	1305
	2				3041	1890	1240	2802	1772	1242	2578	1649	1245	2241	1487	1253	2091	1403	1255
	3	3127	1850	1180	2812	1667	1190	2599	1564	1192	2333	1436	1195	1978	1281	1196	1873	1188	1200
	4	2993	1590	1126	2752	1492	1133	2478	1376	1136	2228	1228	1140	1895	1096	1142	1754	1043	1145
	5	2826	1355	1075	2574	1232	1080	2339	1161	1082	2097	1056	1085	1750	923	1088	1647	873	1090

VOLTAGE	PULLEY TURNS OPEN	0	1	2*	3	4	5
230 - 460-575	RPM WITH 2 HP STD PULLEY	1344	1299	1245	1191	1136	1082

* Factory Setting Turns Open

ACCESSORIES

ROOF CURB

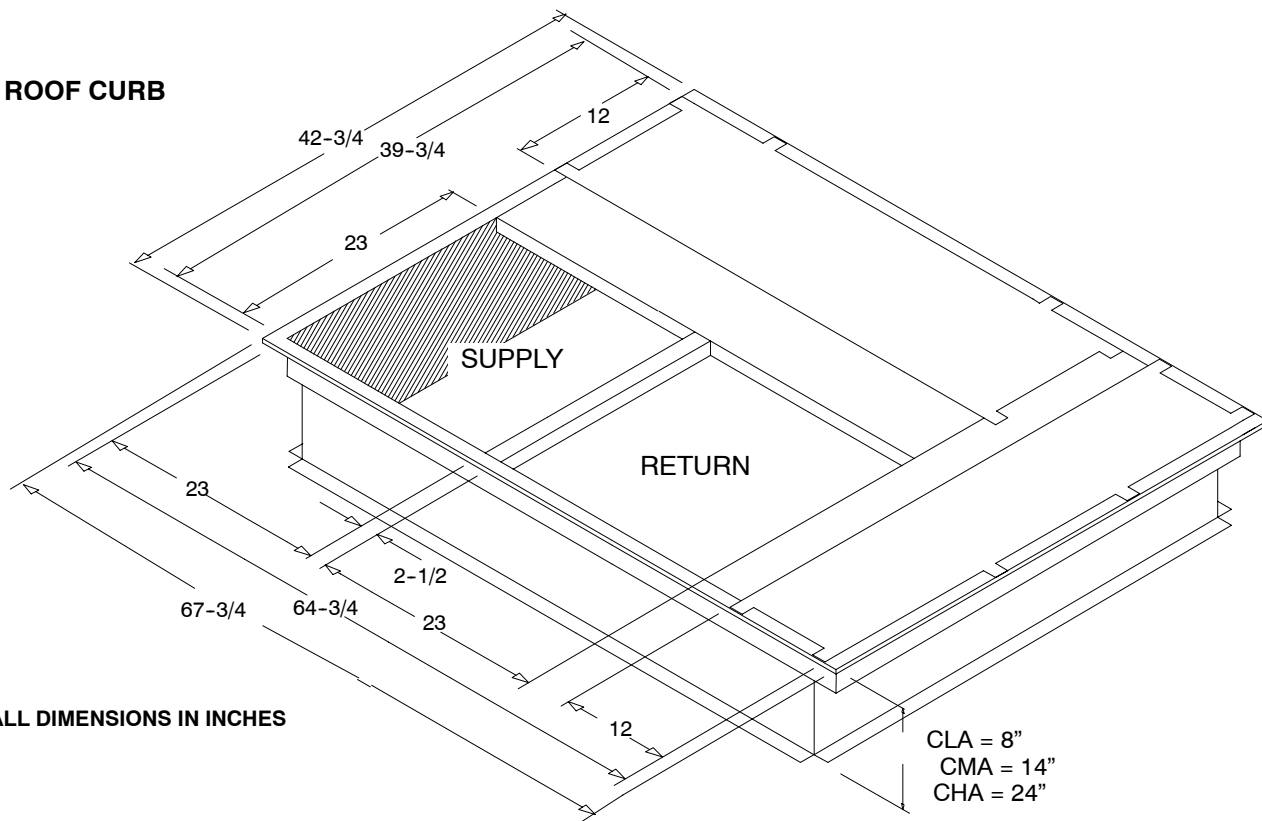

ALL DIMENSIONS IN INCHES

ROOF CURBS

Description	Model Number	Used on
8"	AXB030CLA	7-1/2 Ton
14"	AXB030CMA	7-1/2 Ton
24"	AXB030CHA	7-1/2 Ton

CONCENTRIC DUCT KIT

Description	Mainline Model Number	Used on
Transition	ACT03FB0A	7 1/2 Ton
Grille, Flush Mount	AXB040CFA	7 1/2 Ton
Grille, Step Down	AXB040CSA	7 1/2 Ton

OUTDOOR AIR DAMPERS

Description	Model Number	Used on
Manual - 25%	AXB030FAC	7-1/2 Ton
Motorized - 25%	AXB030FMC	7-1/2 Ton

LOW AMBIENT CONTROLS

Description	Service Parts Number	Used on
To 0° F	1148233	7 1/2 Ton

COIL PROTECTION

Description	Service Parts Number	Used on
Coil Guard	1149486	7-1/2 Ton
Hail Guard	1065342	7-1/2 Ton

FOSSIL FUEL CONVERSION KIT

Description	Service Parts Number	Used on Heat Input
Natural to LP Gas	1084498	150 MBTUH

ECONOMIZERS/DOWNFLOW

ALL DIMENSIONS IN INCHES

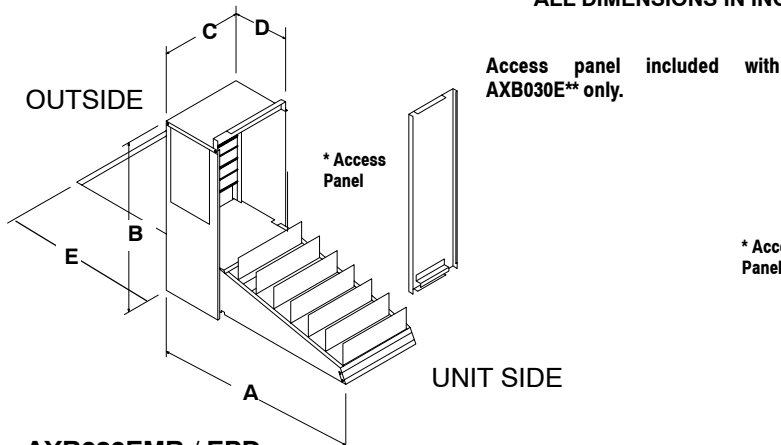

**AXB030EMB / EPD
(Modulating or Three Position)**

Economizer Model No.	A	B	C	D	E
AXB030EMC/PD	35	31	14-3/4	10-7/8	22

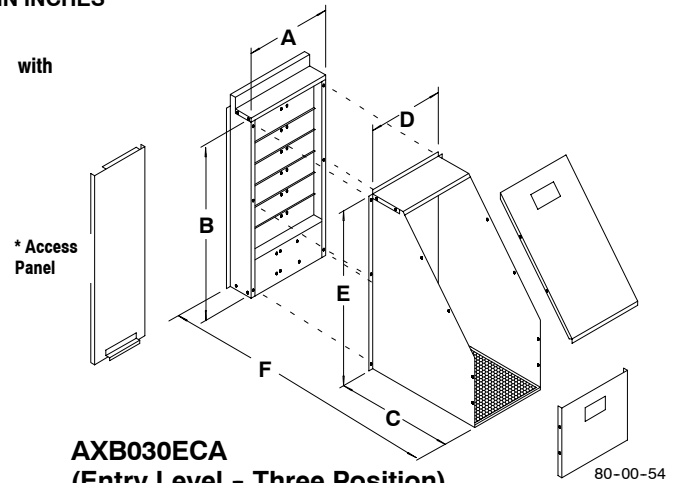

**AXB030ECA
(Entry Level - Three Position)**

Economizer Model No.	A	B	C	D	E	G
AXB030ECA	14-3/4	31	20-1/4	13	30	24

All Economizers Feature Enthalpy and/or ambient temperature control providing outdoor air ventilation and "free cooling" when outdoor conditions are favorable.

Return Air and Pressure Relief dampers for proper air balance, on most models.

Interconnecting wiring furnished.

Center controlled dual action dampers with gaskets to provide proper seal.

Description	Model Number	Used on
Fully Modulating (1)	AXB030EMC	7 1/2 Ton
Three Position (2)	AXB030EPD	
Entry Level Three Position (3)	AXB030ECA	

NOTES:

- (1) - Ambient/Enthalpy Control; Includes Return Air Damper & Relief Damper.
- (2) - Ambient Control Only; Includes Return Air Damper & Relief Damper.
- (3) - Ambient Control Only; No Return Air Damper; No Relief Damper.

ECONOMIZERS/HORIZONTAL

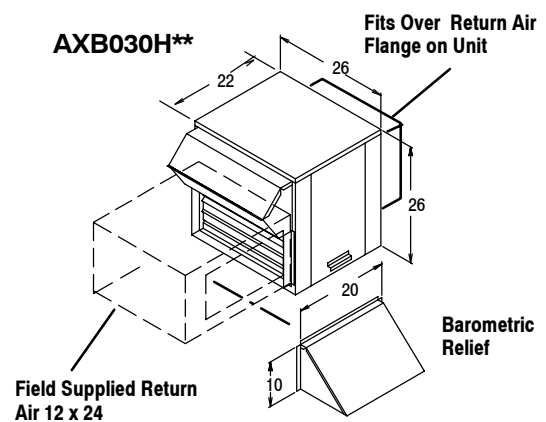

Description	Model Number	Used on
Fully Modulating (1)	AXB030HEC	7 1/2 Ton
Three Position (2)	AXB030HPD	

NOTES:

- (1) - Ambient/Enthalpy Control; Includes Return Air Damper & Relief Damper.
- (2) - Ambient Control Only; Includes Return Air Damper & Relief Damper.

GUIDE SPECIFICATION

CABINET

The cabinet is made of sturdy G-90 galvanized steel, Triple-coated, consisting of a Polyester top coat, a urethane primer coat preceded by an oxide pretreatment. Access panels for easy service. Base rails are 18 gauge steel with fork lift slots and holes provided for lifting shackles. Unit is designed for convertible airflow and is shipped ready for downflow application. Conversion to horizontal airflow is accomplished by relocating two panels.

Return air compartments are insulated with 1"(25.4mm) of water resistant coated glass fiber and 1"(25.4mm) of aluminum foil faced glass fiber in the furnace/supply compartments.

COOLING SECTION

Units are factory charged and operationally ready. Each refrigerant circuit has a compressor with internal overload protection, high and low pressure switches, filter drier, and copper tube/aluminum fin evaporator and condenser coils.

Units are capable of cooling operation down to 40°F (17.4°C) as shipped from the factory.

COILS

The evaporator and condenser coils are fabricated with aluminum fins mechanically bonded to copper tubing. Both coils are pressure tested prior to assembly into the unit and electronically leak tested after assembly into the unit. The evaporator coil is protected from dust and debris on the return air side by factory installed 2"(50.8mm) air filters.

CONDENSER FAN

The unit has a single direct drive propeller fan/motor assembly mounted directly to a vertical-discharge grille panel that is easily removable. Motors are 1140 RPM with permanently lubricated sleeve bearings and inherent overload protection.

EVAPORATOR BLOWER

The units have belt drive blowers for high static applications. The evaporator blower system has the capability to operate against the same rated external static pressure in downflow or horizontal duct designs.

HEATING SECTION

The units have aluminized steel tubular heat exchangers located on the discharge side of the evaporator blower with a single stage gas valve. The units have in-shot burners that are ignited by an electronic hot surface pilot with flame proving feature and protected by both a limit switch and flame roll-out switch. The induced draft blower motor is interlocked with a proven air pressure safety device.

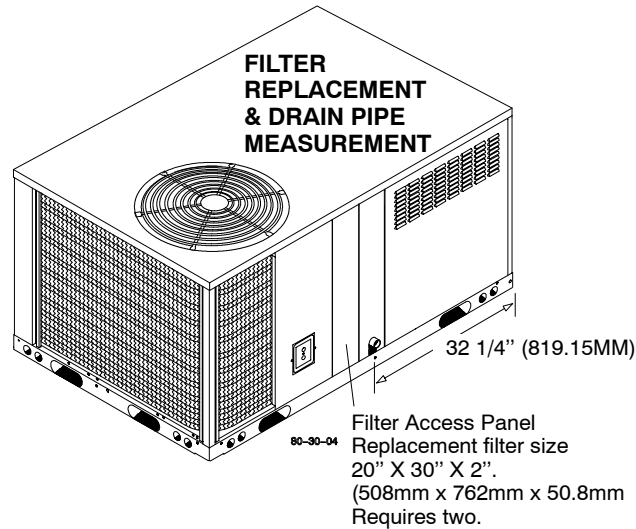

INSTALLATION CLEARANCES

