

**MULTI POSITION
SINGLE STAGE &
2- STAGE
GAS FURNACES**



**Service
Manual**



SUPPLEMENT

Manufactured by:



**Part Number
440 08 2003 00**

Figure 1

Upflow Installations (Dual Certified *9MPD, *9MPT & *9MPV-A4 &3 Models)

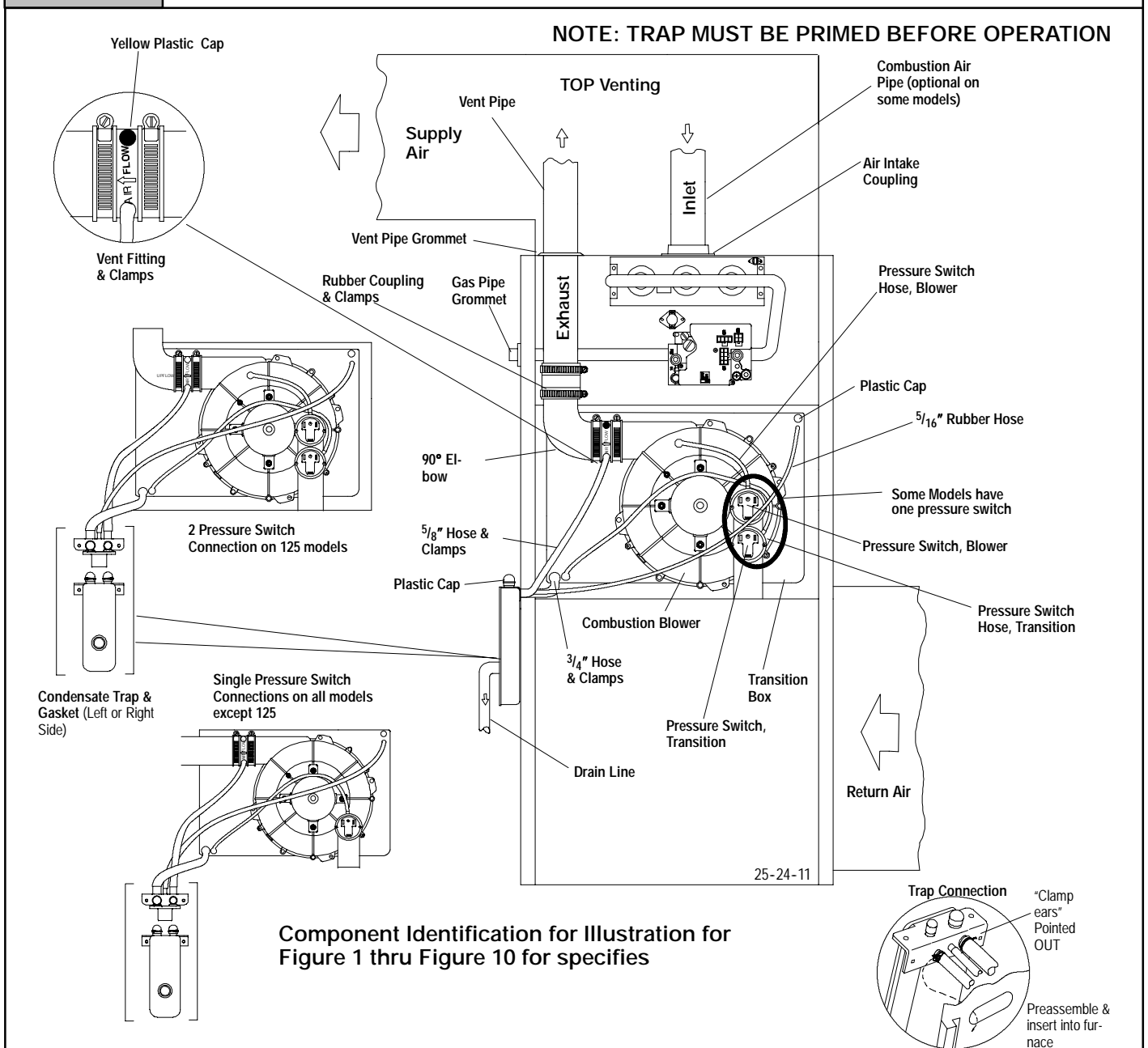

Upflow Installations - (Dual Certified *9MPD, *9MPT & *9MPV)(See Figure 1)

NOTE: DO NOT make connections until the hose routing and lengths have been determined. Remove the condensate trap and drain hoses from the furnace and secure the drain hoses to the drain stubs on the trap with the hose clamps (position the clamps as shown in **Figure 1**). Install the condensate trap/hose assembly to the furnace casing. Hook one side of the "clamp ears" on the drain stub through the hole in the casing and push the condensate trap into position. Secure with the two screws. Reconnect the drain hoses to the stubs on the vent fitting and the plastic transition and secure with the clamps.

Mount the condensate drain trap in a vertical position to either the left or right side of the furnace using the two screws and gasket that are provided. If needed, remove the hole plugs from the furnace side panel and relocate to the open set of holes in the opposite side panel.

NOTE: All gaskets and seals must be in place for sealed combustion applications.

Ensure that the vent fitting and the 90° elbow are securely attached to the combustion blower using the clamps. Note for proper alignment of the vent pipe through the furnace, the 90° elbow must be installed with the "UPFLOW" lettering on the 90° elbow facing out. **NOTE:** The 90° elbow is approved for use inside the furnace ONLY. Plug the upper drain stub on the vent fitting with the yellow plastic cap.

For left side venting, remove 90° elbow from the vent fitting by loosening the clamp on the vent fitting. Securely attach vent fitting to combustion blower.

NOTE: For left side venting, the vent fitting **MUST** be installed with the airflow marking arrow pointed toward the vent pipe, with the drain stub at a 5° to 10° downward slope.

Connect the PVC vent extension pipe to the vent fitting. **This pipe has a built-in channel to assist vent condensate disposal.** Align the arrow on the PVC pipe with the airflow marking arrow on the vent fitting. See label on the PVC pipe for proper installation.

This pipe may only be shortened if an elbow is used to connect the PVC vent extension tube to field-installed vent pipe. Securely attach the PVC vent extension pipe to the vent fitting with the clamp.

This configuration allows left side venting from the furnace. If right side venting is required, the combustion blower must be relocated on the plastic transition box. Loosen the four(4) screws that secure

NOTE: For right side venting, the vent fitting **MUST** be installed with the airflow marking arrow pointed toward the vent pipe, with the drain stub at a 5° to 10° downward slope. (See **Figure 1**)

Plug the upper drain stub on the vent fitting with the yellow plastic cap.

Connect the PVC vent extension pipe to the vent fitting. **This pipe has a built-in channel to assist vent condensate disposal.** Align the arrow on the PVC pipe with the airflow marking arrow on the vent fitting. See label on the PVC pipe for proper installation. This pipe may only be shortened if an elbow is used to connect the PVC vent extension tube to field-installed vent pipe. Securely attach the PVC vent extension pipe to the vent fitting with the clamp.

the blower to the transition approximately 1/2". Rotate the blower 180° and secure with the four(4) screws. Note that some combustion blowers have plastic spacers on the mounting legs of the blower located at the 6 and 12 o'clock positions (blower snout to the left or right) that are required for proper fit up of the blower to the transition. Use caution to not over tighten the screws to prevent stripping out of the plastic mounting holes.

For left side mounted condensate trap, connect the 3/4" OD rubber hose with the 90° bend to the large drain stub on the condensate trap and secure with a 3/4" clamp.

Route the hose to the drain stub on the bottom of the plastic transition box. Cut off excess hose and discard. Connect the hose to the drain stub on the transition and secure with a 3/4" clamp.

For right side mounted condensate trap, connect the 3/4" OD rubber hose with the 90° bend to the bottom of the plastic transition box and secure with a 3/4" clamp.

Route the hose to the large drain stub on the condensate trap. Cut off excess hose and discard. Connect the hose to the drain stub on the condensate trap and secure with a 3/4" clamp.

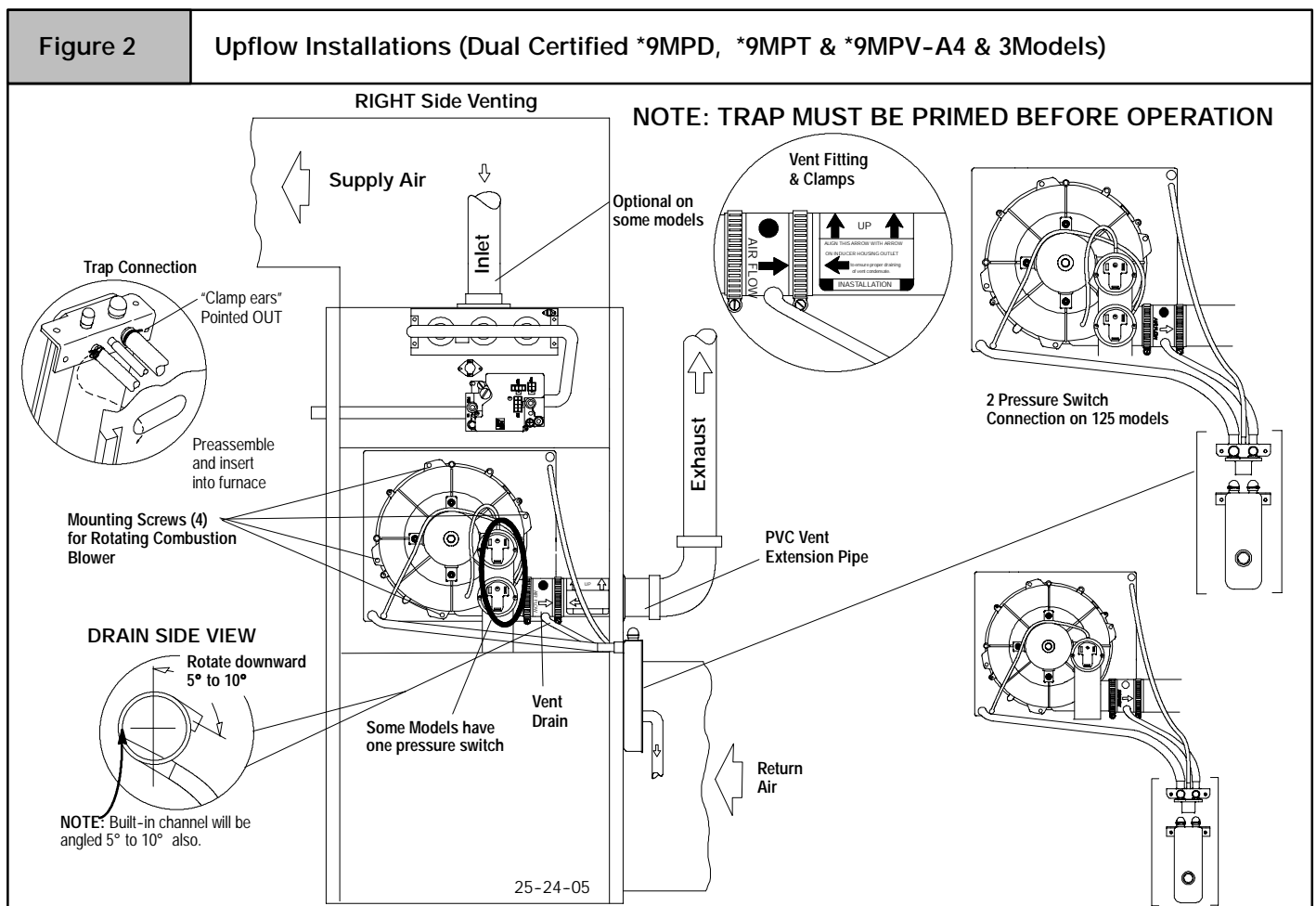

For left or right side mounted condensate trap, the pressure tap on the condensate trap **MUST** be connected to the unused pressure tap located on the upper right hand corner of the plastic transition box. Remove the plastic caps from the pressure taps on the condensate trap and the plastic transition and connect with the 5/16" OD rubber hose. (See **Figure 1** and **Figure 2**)

Connect the 5/8" OD rubber hose with the 90° bend to the lower

drain stub on the vent fitting and secure with a 5/8" clamp.

Route the hose to the small drain stub on the condensate trap. Cut off excess hose and discard. Connect the hose to the drain stub on the trap and secure with a 5/8" clamp.

NOTE: Route hoses to the condensate trap with no kinking or binding for proper condensate drainage.

Figure 3

Horizontal Left Installations (Dual Certified *9MPD, *9MPT & *9MPV-A4 & 3 Models)

NOTE: TRAP MUST BE PRIMED BEFORE OPERATION

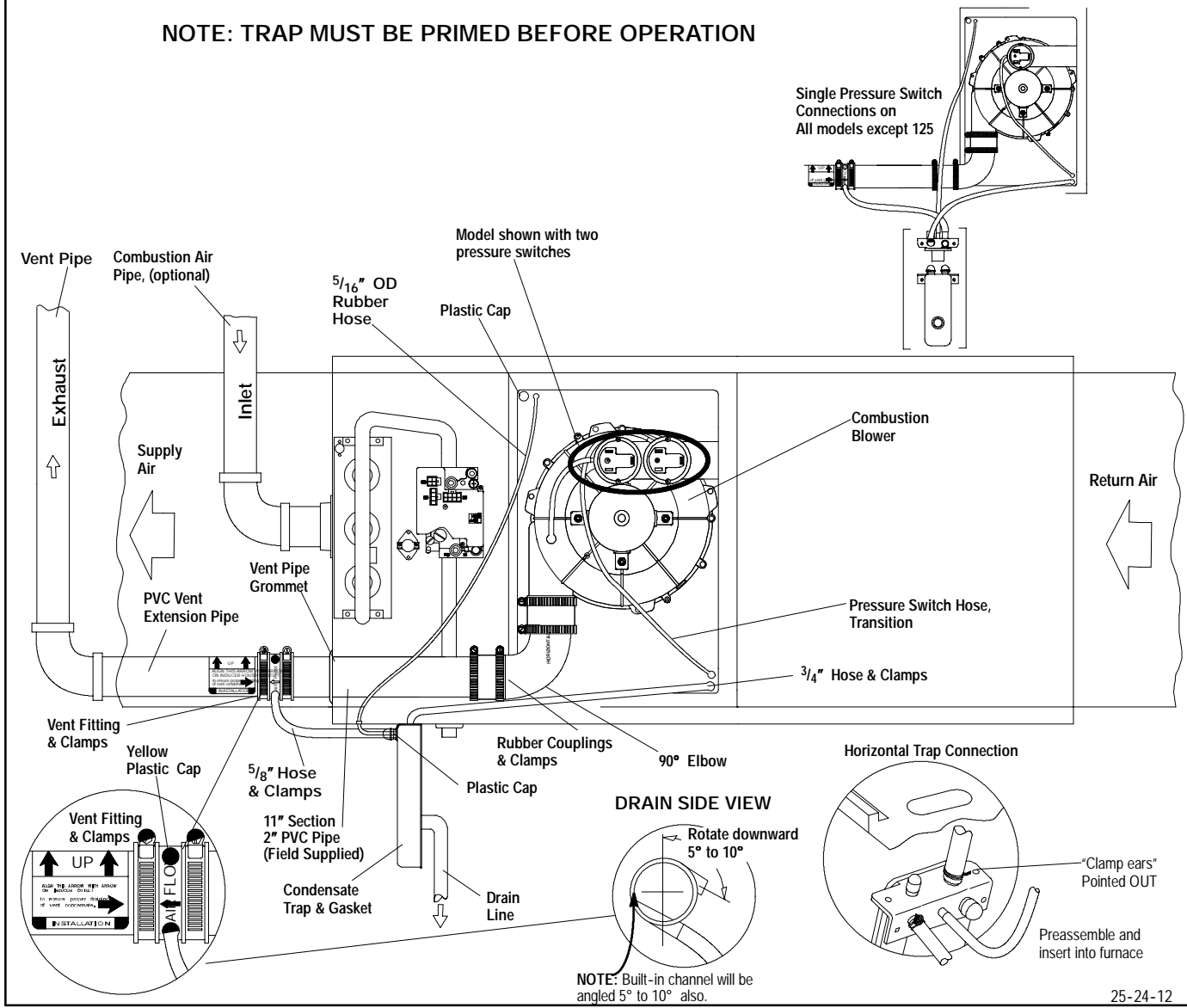

Horizontal Left Installations - (Dual Certified *9MPD) (See Figure 3)

Note: DO NOT make hose connections until the hose routing and lengths have been determined. Remove the condensate trap and drain hoses from the furnace and secure the drain hoses to the drain stubs on the trap with the hose clamps (position the clamps as shown in **Figure 3**). Install the condensate trap/hose assembly to the furnace casing. Hook one side of the "clamp ears" on the drain stub through the hole in the casing and push the condensate trap into position. Secure with the two screws. Reconnect the drain hoses to the stubs on the vent fitting and the plastic transition and secure with the clamps.

Relocate the plastic cap and clamp from the vertical transition drain stub to the horizontal transition drain stub on the condensate drain trap. Secure the clamps tightly to prevent condensate leakage. Do not change the cap and clamp on the vent drain stub.

Mount the condensate drain trap in a vertical position to the left side of the furnace using the two screws and gasket that are provided. Note: The condensate trap will be located under the furnace in a vertical position when the furnace is placed horizontally on the left side. If needed, remove the hole plugs from the furnace side panel and relocate to the open set of holes in the opposite side panel.

NOTE: All gaskets and seals must be in place for sealed combustion applications.

Remove the 90° elbow and vent fitting from the combustion blower by loosening the clamps on the vent fitting. Connect the 90° elbow to the combustion blower using the rubber coupling and clamps. Note for proper alignment of the vent pipe through the furnace, the 90° elbow must be installed with the "HORIZONTAL" lettering on the 90° elbow facing out. Connect a 11" section of 2" PVC pipe (field supplied) to the 90° elbow using the rubber coupling and clamps. The PVC pipe will extend through the top panel about 1 1/2". Connect the vent fitting to the end of the 11" section of PVC pipe using the clamp.

NOTE: The 90° elbow is approved for use inside the furnace ONLY.

NOTE: The vent fitting **MUST** be installed with the airflow marking arrow pointed toward the vent pipe, with the drain stub at a 5° to 10° downward slope.

Plug the upper drain stub on the vent fitting with the yellow plastic cap.

Connect the PVC vent extension pipe to the vent fitting. **This pipe has a built-in channel to assist vent condensate disposal.**

Align the arrow on the PVC pipe with the airflow marking arrow on the vent fitting. See label on the PVC pipe for proper installation. This pipe may only be shortened if an elbow is used to connect the PVC vent extension tube to field-installed vent pipe. Securely attach the PVC vent extension pipe to the vent fitting with the clamp.

Connect the $\frac{5}{8}$ " OD rubber hose with the 90° bend to the lower drain stub on the vent fitting and secure with a $\frac{5}{8}$ " clamp.

Route the hose to the horizontal drain stub on the condensate trap. Cut off excess hoses and discard. Connect the hose to the drain stub on the condensate trap and secure with a $\frac{5}{8}$ " clamp.

Connect the $\frac{3}{4}$ " OD rubber hose with the 90° bend to the large drain stub on the condensate trap and secure with a $\frac{3}{4}$ " clamp.

Route the hose to the drain stub on the bottom of the plastic transition box. Cut off excess hose and discard. Connect the hose to the drain stub on the transition and secure with a $\frac{3}{4}$ " clamp.

The pressure tap on the condensate trap MUST be connected to the unused pressure tap located on the top of the plastic transition box. Remove the plastic caps from the pressure taps on the condensate trap and the plastic transition and connect with the $\frac{5}{16}$ " OD rubber hose.

NOTE: This will require drilling a $\frac{5}{16}$ " OD hole in the furnace casing next to the condensate trap.

NOTE: Ensure hoses maintain a downward slope to the condensate trap with no kinking or binding for proper condensate drainage.

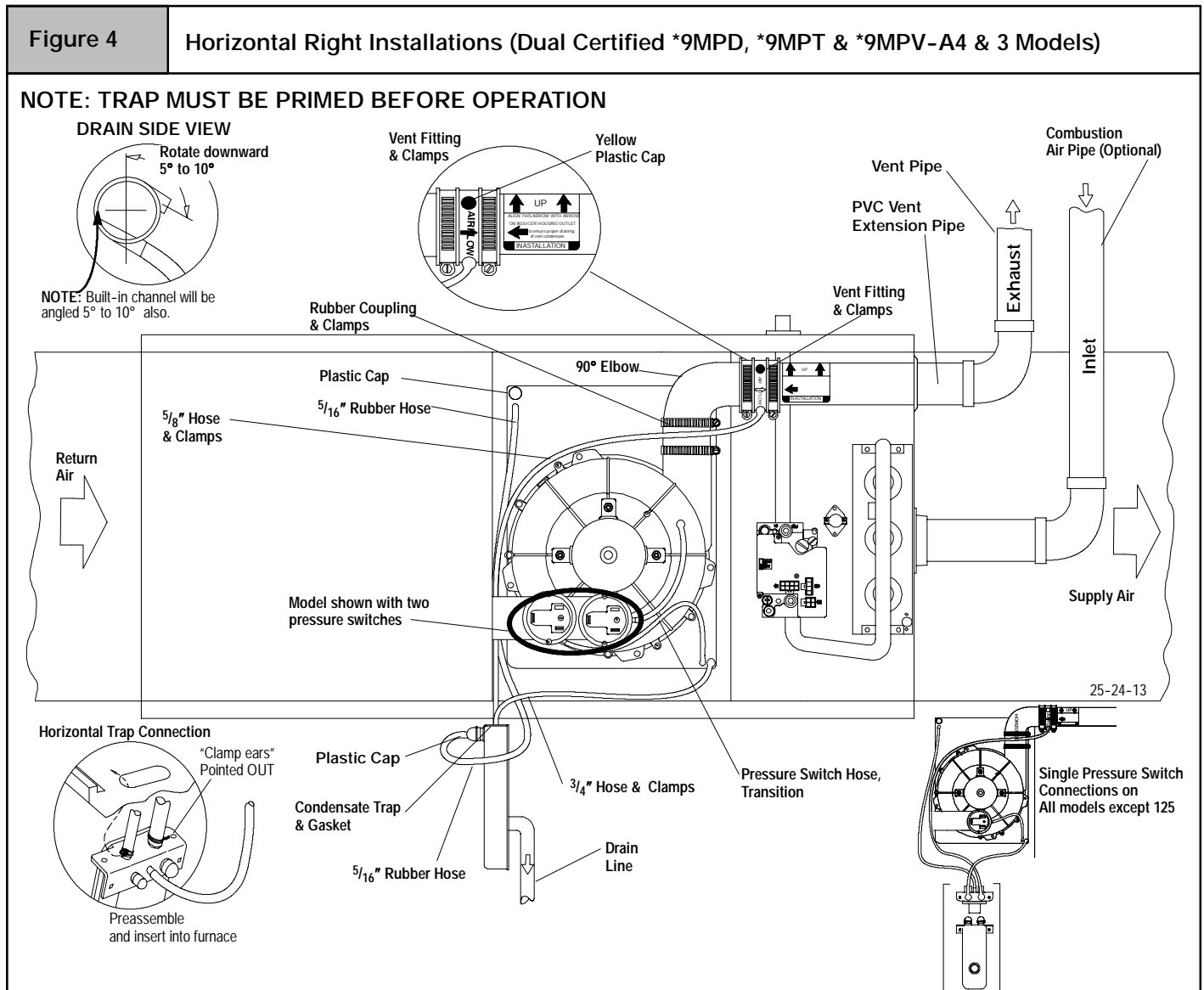

Horizontal Right Installations - (Dual Certified *9MPD) (See Figure 4)

Note: DO NOT make hose connections until the hose routing and lengths have been determined. Remove the condensate trap and drain hoses from the furnace and secure the drain hoses to the drain stubs on the trap with the hose clamps (position the clamps as shown in **Figure 4**). Install the condensate trap/hose assembly to the furnace casing. Hook one side of the "clamp ears" on the drain stub through the hole in the casing and push the condensate trap into position. Secure with the two screws. Reconnect the drain hoses to the stubs on the vent fitting and the plastic transition and secure with the clamps.

Relocate the plastic caps and clamps on the condensate drain trap from the vertical drain stub to the horizontal drain stubs. Secure the clamps tightly to prevent condensate leakage.

Mount the condensate drain trap in a vertical position to the right side of the furnace using the two screws and gasket that are provided. Note: The condensate trap will be located under the furnace in a vertical position when the furnace is placed horizontally on the right side. If needed, remove the hole plugs from the furnace side

panel and relocated to the open set of holes in the opposite side panel.

NOTE: All gaskets and seals must be in place for sealed combustion applications.

Remove the 90° elbow and vent fitting from the combustion blower by loosening the clamps on the vent fitting. Connect the 90° elbow to the combustion blower using the rubber coupling and clamps. Note for proper alignment of the vent pipe through the furnace, the 90° elbow must be installed with the "HORIZONTAL" lettering on the 90° elbow facing out. Connect the vent fitting to the end of the 90° elbow using the clamp.

NOTE: The 90° elbow is approved for use inside the furnace ONLY.

NOTE: The vent fitting MUST be installed with the airflow marking arrow pointed toward the vent pipe, with the drain stub at a 5° to 10° downward slope.

Plug the upper drain stub on the vent fitting with the yellow plastic cap.

Connect the PVC vent extension pipe to the vent fitting. **This pipe has a built-in channel to assist vent condensate disposal.** Align the arrow on the PVC pipe with the airflow marking arrow on the vent fitting. See label on the PVC pipe for proper installation. This pipe may only be shortened if an elbow is used to connect the PVC vent extension tube to field-installed vent pipe. Securely attach the PVC vent extension pipe to the vent fitting with the clamp.

Remove the pressure switch hose from the upper stub on the plastic transition box.

Relocate the plastic caps on the stubs of the plastic transition box from the lower stubs to the upper stubs and secure tightly with the clamps.

Route the pressure switch hose to the lower stub on the plastic transition box. Cut off excess hose and discard. Connect the pressure switch hose to the lower stub on the plastic transition box. Ensure that the hose is routed above the stub on the transition box so that condensate does not collect in the hose. **NOTE:** Failure to correctly install the pressure switch hose to the transition can adversely affect the safety control operation.

Connect the 3/4" OD rubber hose with the 90° bend to the large drain stub on the condensate trap and secure with a 3/4" clamp.

Route the hose to the drain stub on the bottom of the plastic transition box. Cut off excess hose and discard. Connect the hose to the drain stub on the transition and secure with a 3/4" clamp.

Connect the 5/8" OD rubber hose with the 90° bend to the lower drain stub on the vent fitting and secure with a 5/8" clamp.

Route the hose to the smaller drain stub on the condensate trap. Cut off excess hose and discard. Connect the hose to the drain stub on the trap and secure with a 5/8" clamp.

NOTE: Route hoses to the condensate trap with no kinking or binding for proper condensate drainage.

Figure 5

Downflow Installations (Dual Certified *9MPD, *9MPT & *9MPV-A4 & 3 Models)

NOTE: TRAP MUST BE PRIMED BEFORE OPERATION

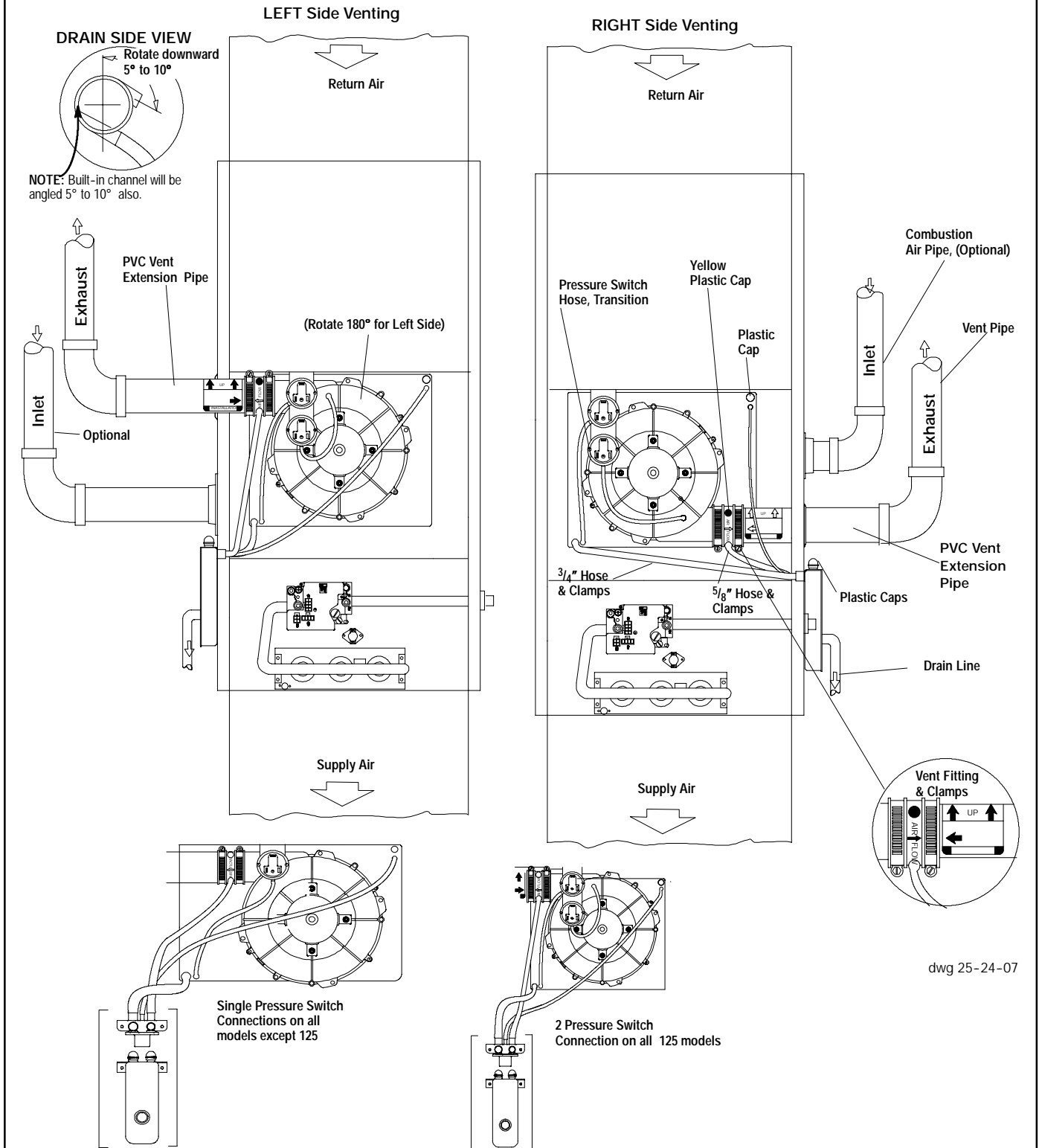

dwg 25-24-07

Downflow Installations - (Dual Certified *9MPD Models) (See Figure 5)

NOTE: DO NOT make hose connections until the hose routing and lengths have been determined. Remove the condensate trap and drain hoses from the furnace and secure the drain hoses to the drain stubs on the trap with the hose clamps (position the clamps as shown in **Figure 5**). Install the condensate trap/hose assembly to the furnace casing. Hook one side of the "clamp ears" on the drain

sub through the hole in the casing and push the condensate trap into position. Secure with the two screws. Reconnect the drain hoses to the stubs on the vent fitting and the plastic transition and secure with the clamps.

Mount the condensate drain trap in a vertical position to either the right or left side of the furnace using the two screws and gasket that are provided. If needed, remove the hole plugs from the furnace side panel and relocate to the open set of holes in the opposite side panel.

NOTE: All gaskets and seals must be in place for sealed combustion applications.

For both right and left side vent, remove the 90° elbow from the vent fitting by loosening the clamp on the vent fitting.

Ensure that the vent fitting is securely attached to the combustion blower using the rubber coupling and clamps.

Connect the PVC vent extension pipe to the vent fitting. **This pipe has a built-in channel to assist vent condensate disposal.** Align the arrow on the PVC pipe with the airflow marking arrow on the vent fitting. See label on the PVC pipe for proper installation. This pipe may only be shortened if an elbow is used to connect the PVC vent extension tube to field-installed vent pipe. Securely attach the PVC vent extension pipe to the vent fitting with the clamp.

This configuration allows left side venting from the furnace. If right side venting is required, the combustion blower must be relocated on the plastic transition box. Loosen the four(4) screws that secure the blower to the transition approximately 1/2". Rotate the blower 180° and secure with the four(4) screws. Note that some combustion blowers have plastic spacers on the mounting legs of the blower located at the 6 and 12 o'clock positions (blower snout to the left or right) that are required for proper fit up of the blower to the transition. Use caution to not over tighten the screws to prevent stripping out of the plastic mounting holes.

NOTE: The vent fitting **MUST** be installed with the airflow marking arrow pointed toward the vent pipe, with the drain stub at a 5° to 10° downward slope.

Plug the upper drain stub on the vent fitting with the yellow plastic cap.

Connect the PVC vent extension pipe to the vent fitting. **This pipe has a built-in channel to assist vent condensate disposal.**

Align the arrow on the PVC pipe with the airflow marking arrow on the vent fitting. See label on the PVC pipe for proper installation. This pipe may only be shortened if an elbow is used to connect the PVC vent extension tube to field-installed vent pipe. Securely attach the PVC vent extension pipe to the vent fitting with the clamp.

Remove the pressure switch hose from the upper stub on the plastic transition box.

Relocate the plastic caps on the stubs of the plastic transition box from the lower stubs to the upper stubs and secure tightly with the clamps.

Route the pressure switch hose to the lower stub on the plastic transition box. Cut off excess hose and discard. Connect the pressure switch hose to the lower stub on the plastic transition box. **NOTE:** Failure to correctly install the pressure switch hose to the transition box can adversely affect the safety control operation.

Connect the 3/4" OD rubber hose with the 90° bend to the drain stub on the bottom of the plastic transition box and secure with a 3/4" clamp.

Route the hose to the large drain stub on the condensate trap. Cut off excess hose and discard. Connect the hose to the drain stub on the transition and secure with a 3/4" clamp.

Connect the 5/8" OD rubber hose with the 90° bend to the lower drain stub on the vent fitting and secure with a 5/8" clamp.

Route the hose to the smaller stub on the condensate trap. Cut off excess hose and discard. Connect the hose to the drain stub on the trap and secure with a 5/8" clamp.

For left side or right side mounted condensate trap, the pressure tap on the condensate trap **MUST** be connected to the unused pressure tap located on the top of the plastic transition box. Remove the plastic caps from the pressure taps on the condensate trap and the plastic transition and connect the 5/16" OD rubber hose. (See **Figure 5**)

NOTE: Route hoses to the condensate trap with no kinking or binding for proper condensate drainage.

Figure 6

Upflow Installations (Single Pipe N9MP1 & Direct Vent N9MP2-A4 & 3 Models)

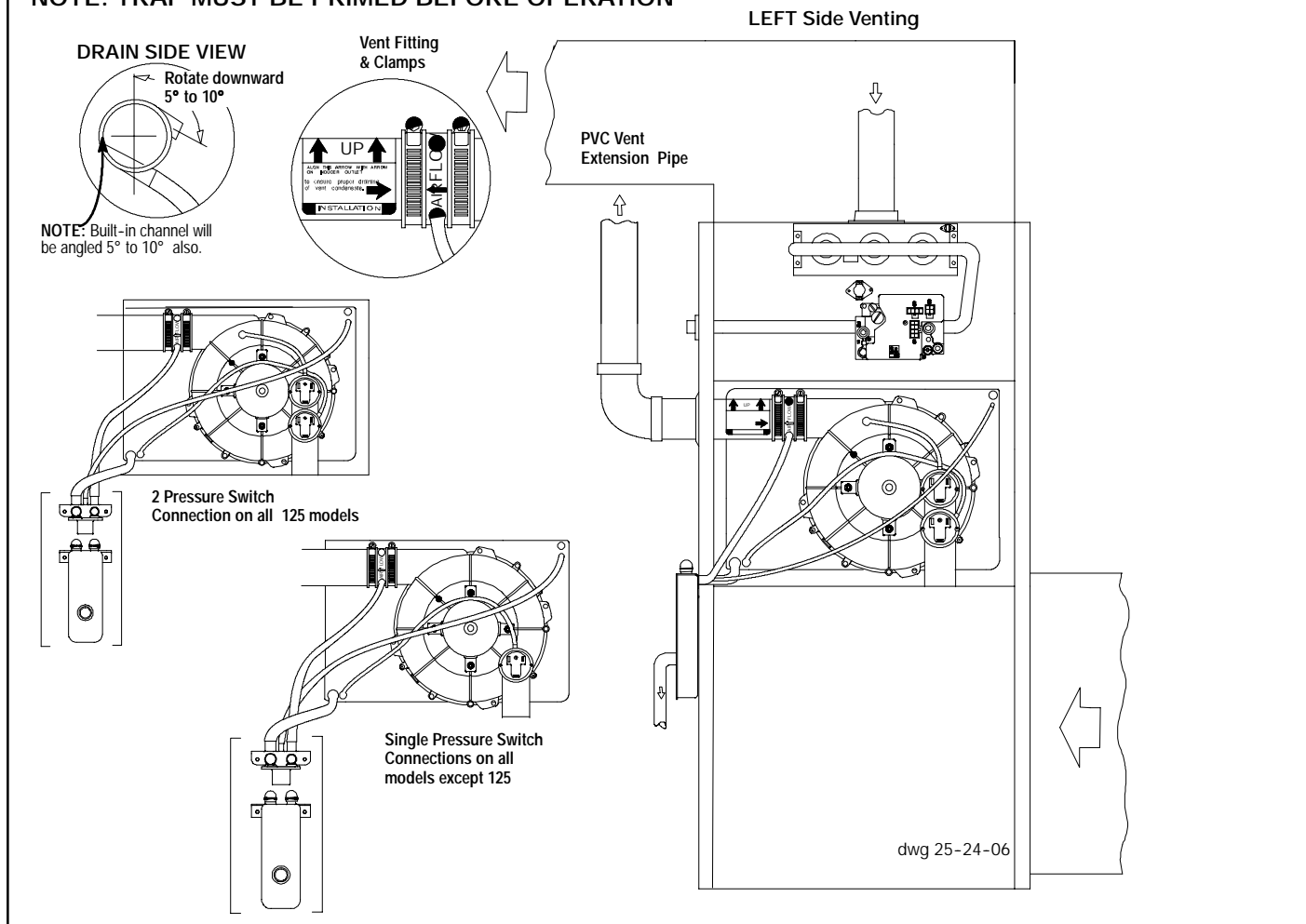
NOTE: TRAP MUST BE PRIMED BEFORE OPERATION**Upflow Installations - (Single Pipe & Direct Vent N9MP1 & N9MP2 Models) (See Figure 6)**

NOTE: DO NOT make hose connections until the hose routing and lengths have been determined. Remove the condensate trap and drain hoses from the furnace and secure the drain hoses to the drain stubs on the trap with the hose clamps (position the clamps as shown in **Figure 6**). Install the condensate trap/hose assembly to the furnace casing. Hook one side of the "clamp ears" on the drain stub through the hole in the casing and push the condensate trap into position. Secure with the two screws. Reconnect the drain hoses to the stubs on the vent fitting and the plastic transition and secure with the clamps.

Mount the condensate drain trap in a vertical position to either the left or right side of the furnace using the two screws and gasket that are provided. If needed, remove the hole plugs from the furnace side panel and relocate to the open set of holes in the opposite side panel.

NOTE: All gaskets and seals must be in place for sealed combustion applications.

Ensure that the vent fitting is securely attached to the combustion blower using the rubber coupling and clamps.

NOTE: For left side venting, the vent fitting **MUST** be installed with the airflow marking arrow pointed toward the vent pipe, with the drain stub at a 5° to 10° downward slope.

Connect the PVC vent extension pipe to the vent fitting. **This pipe has a built-in channel to assist vent condensate disposal.**

Align the arrow on the PVC pipe with the airflow marking arrow on the vent fitting. See label on the PVC pipe for proper installation. This pipe may only be shortened if an elbow is used to connect the PVC vent extension tube to field-installed vent pipe. Securely attach the PVC vent extension pipe to the vent fitting with the clamp.

This configuration allows left side venting from the furnace. If right side venting is required, the combustion blower must be relocated on the plastic transition box. Loosen the four(4) screws that secure the blower to the transition approximately $1/2$ ". Rotate the blower 180° and secure with the four(4) screws. Note that some combustion blowers have plastic spacers on the mounting legs of the blower located at the 6 and 12 o'clock positions (blower snout to the left or right) that are required for proper fit up of the blower to the transition. Use caution to not over tighten the screws to prevent stripping out of the plastic mounting holes.

NOTE: For right side venting, the vent fitting **MUST** be installed with the airflow marking arrow pointed toward the vent pipe, with the drain stub at a 5° to 10° downward slope. (See **Figure 18**)

Plug the upper drain stub on the vent fitting with the yellow plastic cap.

Connect the PVC vent extension pipe to the vent fitting. **This pipe has a built-in channel to assist vent condensate disposal.** Align the arrow on the PVC pipe with the airflow marking arrow on the vent fitting. See label on the PVC pipe for proper installation. This pipe may only be shortened if an elbow is used to connect the

PVC vent extension tube to field-installed vent pipe. Securely attach the PVC vent extension pipe to the vent fitting with the clamp. For left side mounted condensate trap, connect the $\frac{3}{4}$ " OD rubber hose with the 90° bend to the large drain stub on the condensate trap and secure with a $\frac{3}{4}$ " clamp. Route the hose to the drain stub on the bottom of the plastic transition box. Cut off excess hose and discard. Connect the hose to the

drain stub on the transition and secure with a $\frac{3}{4}$ " clamp. For right side mounted condensate trap, connect the $\frac{3}{4}$ " OD rubber hose with the 90° bend to the bottom of the plastic transition box and secure with a $\frac{3}{4}$ " clamp. Route the hose to the large drain stub on the condensate pump. Cut off excess hose and discard. Connect the hose to the drain stub on the condensate trap and secure with a $\frac{3}{4}$ " clamp.

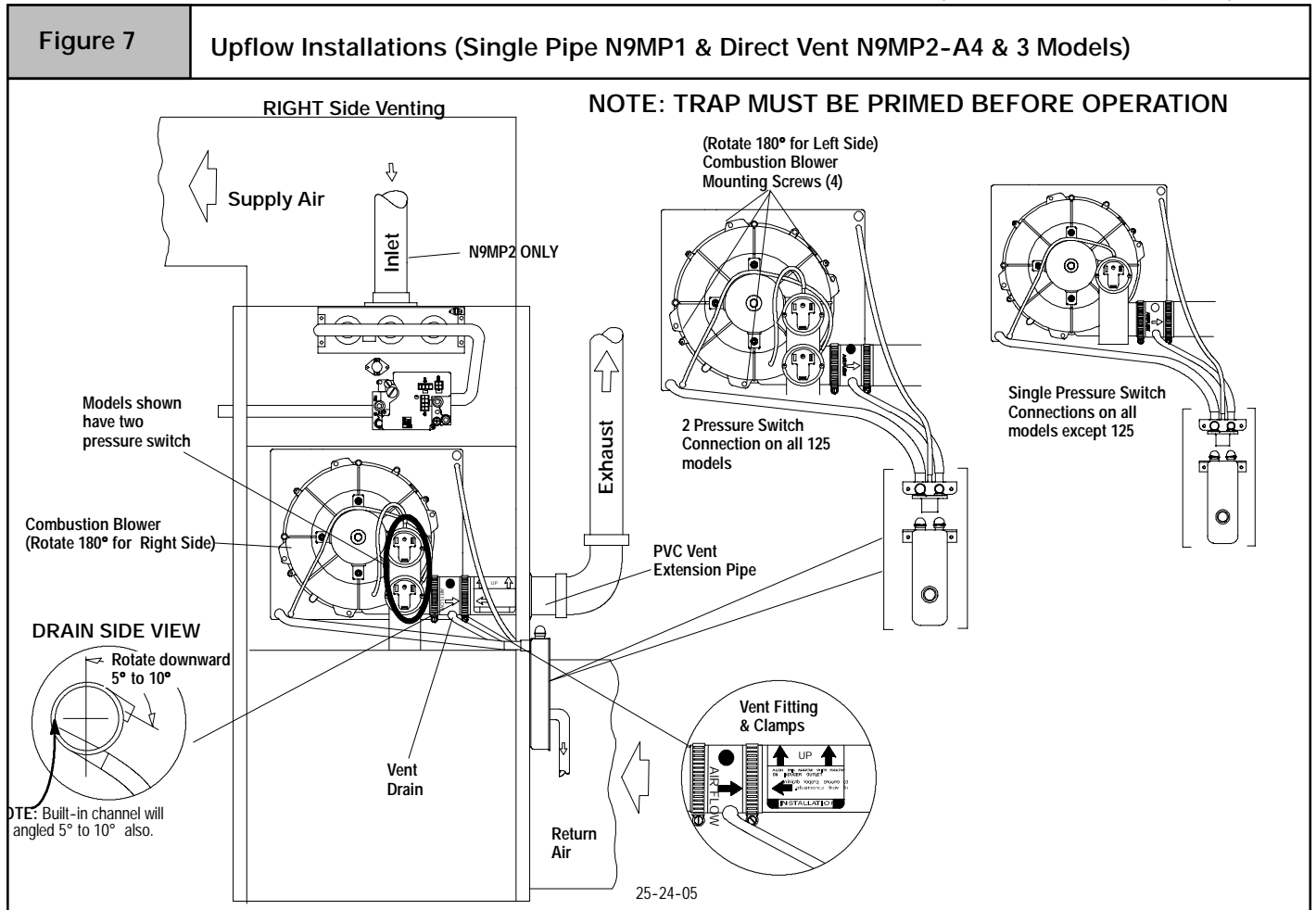

For left side or right side mounted condensate trap, the pressure tap on the condensate trap MUST be connected to the unused pressure tap located on the upper right hand corner of the plastic transition box. Remove the plastic caps from the pressure taps on the condensate trap and the plastic transition and connect with the $\frac{5}{16}$ " OD rubber hose. (See Figure 7 and Figure 18) Connect the $\frac{5}{8}$ " OD rubber hose with the 90° bend to the lower

drain stub on the vent fitting and secure with a $\frac{5}{8}$ " clamp. Route the hose to the smaller drain stub on the condensate trap. Cut off excess hose and discard. Connect the hose to the drain stub on the trap and secure with a $\frac{5}{8}$ " clamp. **NOTE:** Route hoses to the condensate trap with no kinking or binding for proper condensate drainage.

Figure 8

Horizontal Left Installations (Single Pipe N9MP1 & Direct Vent N9MP2-A4 & 3 Models)

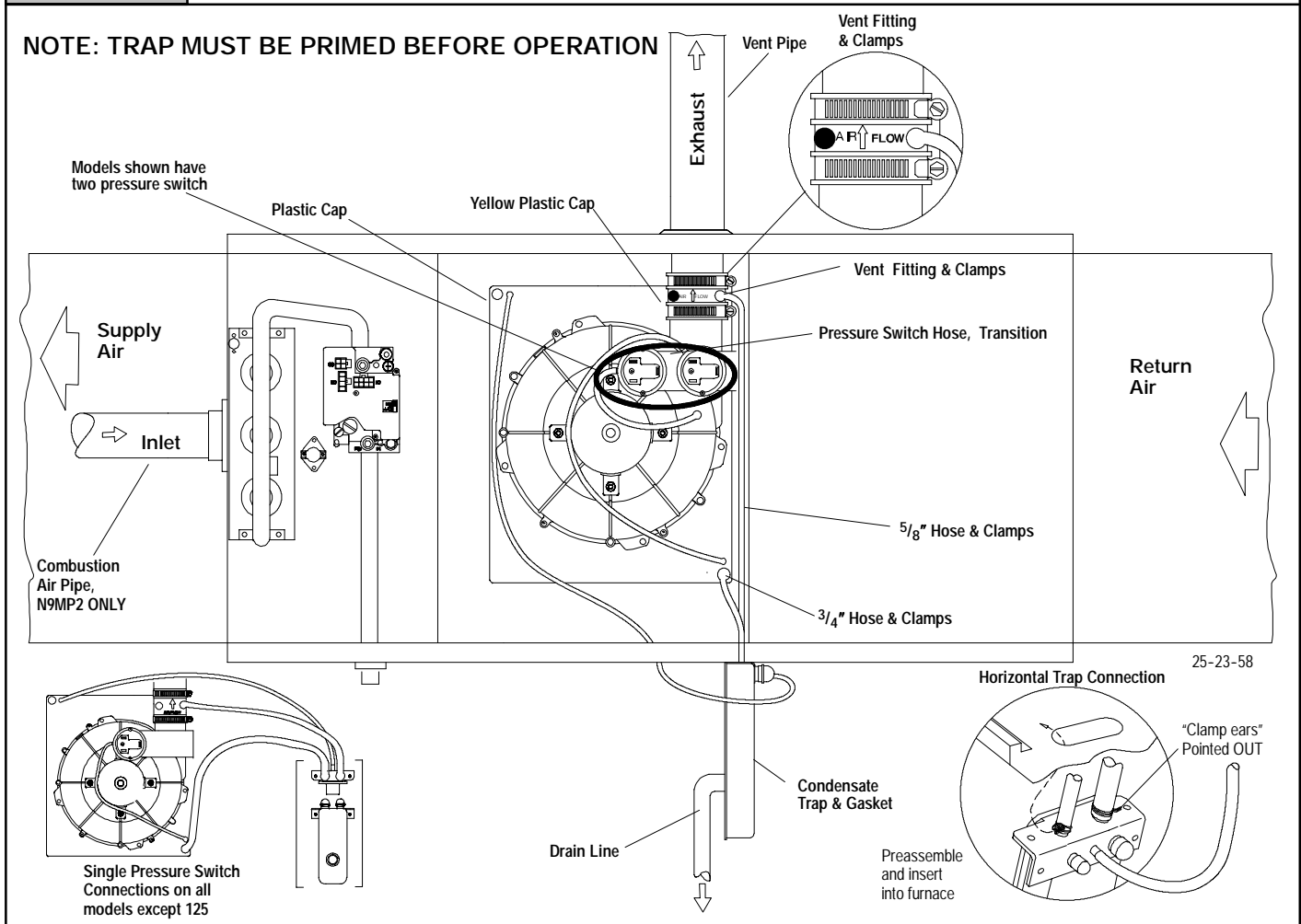

Horizontal Left Installations - (Single Pipe & Direct Vent N9MP1 & N9MP2 Models) (See Figure 8)

NOTE: DO NOT make hose connections until the hose routing and lengths have been determined. Remove the condensate trap and drain hoses from the furnace and secure the drain hoses to the drain stubs on the trap with the hose clamps (position the clamps as shown in **Figure 8**). Install the condensate trap/hose assembly to the furnace casing. Hook one side of the "clamp ears" on the drain stub through the hole in the casing and push the condensate trap into position. Secure with the two screws. Reconnect the drain hoses to the stubs on the vent fitting and the plastic transition and secure with the clamps.

Relocate the plastic caps and clamps on the condensate drain trap from the vertical drain stubs to the horizontal drain stubs. Secure the clamps tightly to prevent condensate leakage.

Mount the condensate drain trap in a vertical position to the left side of the furnace using the two screws and gasket that are provided. Note: The condensate trap will be located under the furnace in a vertical position when the furnace is placed horizontally on the left side. If needed, remove the hole plugs from the furnace side panel and relocated to the open set of holes in the opposite side panel.

NOTE: All gaskets and seals must be in place for sealed combustion applications.

Relocate the combustion blower on the plastic transition box. Remove the four(4) screws that secure the blower to the transition box. Rotate the blower 180° so the blower snout is pointing up and

secure with the four(4) screws. Note that some combustion blowers have plastic spacers on the mounting legs of the blower located at the 6 and 12 o'clock positions (blower snout to the left or right) that are required for proper fit up of the blower to the transition. Use caution to not over tighten the screws to prevent stripping out of the plastic mounting holes.

Ensure that the vent fitting is securely attached to the combustion blower using the rubber coupling and clamps.

NOTE: The vent fitting **MUST** be installed with the airflow marking arrow pointed toward the vent pipe.

Plug the left drain stub on the vent fitting with the yellow plastic cap.

Connect the 3/4" OD rubber hose with the 90° bend to the large drain stub on the condensate trap and secure with a 3/4" clamp.

Route the hose to the drain stub on the bottom of the plastic transition box. Cut off excess hose and discard. Connect the hose to the drain stub on the transition and secure with a 3/4" clamp.

Connect the 5/8" OD rubber hose with the 90° bend to the right drain stub on the vent fitting and secure with a 5/8" clamp.

Route the hose to the smaller drain stub on the condensate trap. Cut off excess hose and discard. Connect the hose to the drain stub on the vent fitting and secure with a 5/8" clamp.

NOTE: Route hoses to the condensate trap with no kinking or binding for proper condensate drainage.

Figure 9

Horizontal Right Installations (Single Pipe & Direct Vent N9MP1 & N9MP2-A4 & 3 Models)

NOTE: TRAP MUST BE PRIMED BEFORE OPERATION

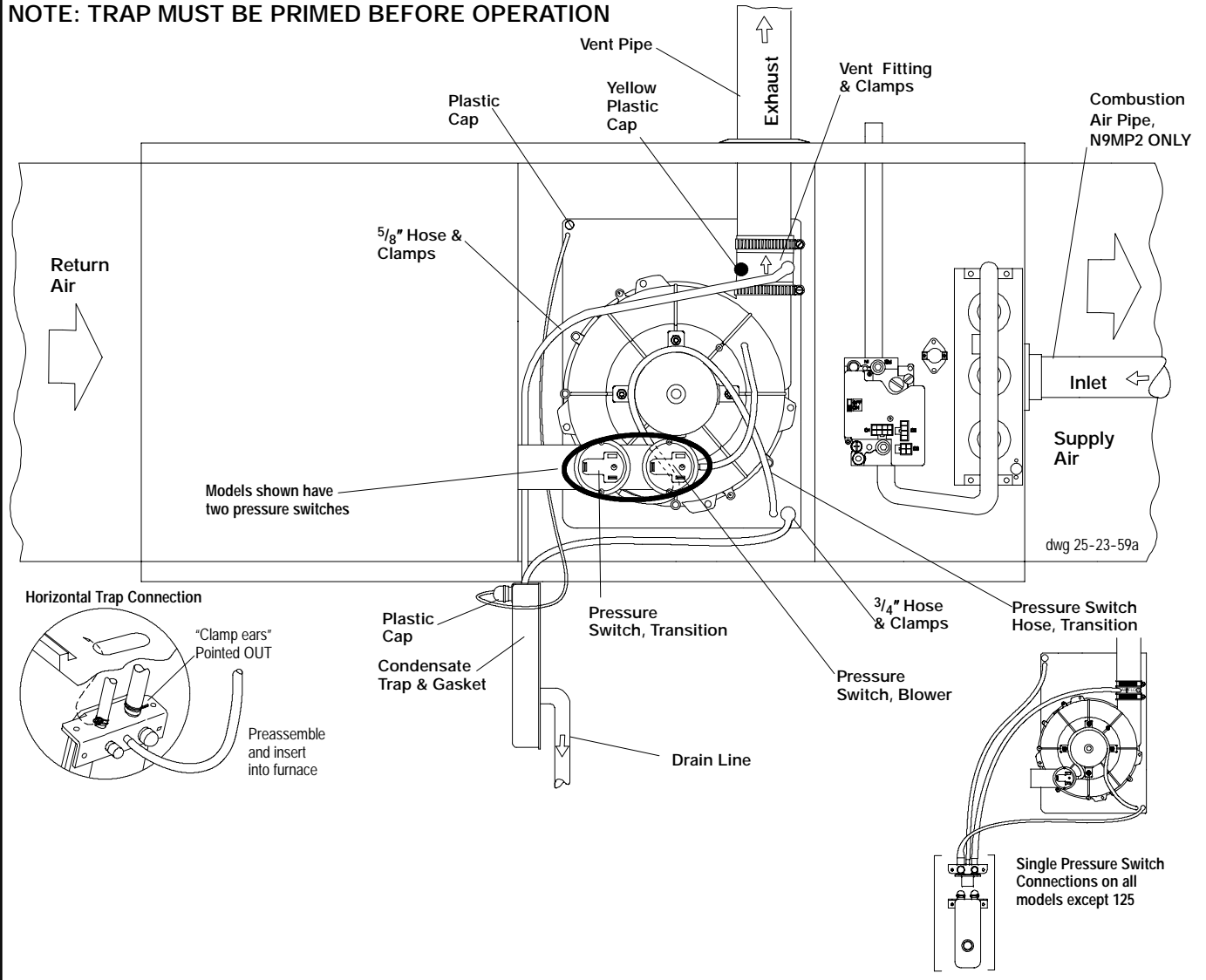

Horizontal Right Installations - (Single Pipe & Direct Vent N9MP1 & N9MP2 Models) (See Figure 9)

NOTE: DO NOT make hose connections until the hose routing and lengths have been determined. Remove the condensate trap and drain hoses from the furnace and secure the drain hoses to the drain stubs on the trap with the hose clamps (position the clamps as shown in **Figure 9**). Install the condensate trap/hose assembly to the furnace casing. Hook one side of the "clamp ears" on the drain stub through the hole in the casing and push the condensate trap into position. Secure with the two screws. Reconnect the drain hoses to the stubs on the vent fitting and the plastic transition and secure with the clamps.

Relocate the plastic caps and clamps on the condensate drain trap from the vertical drain stub to the horizontal drain stubs. Secure the clamps tightly to prevent condensate leakage.

Mount the condensate drain trap in a vertical position to the right side of the furnace using the two screws and gasket that are provided. Note: The condensate trap will be located under the furnace in a vertical position when the furnace is placed horizontally on the right side. If needed, remove the hole plugs from the furnace side panel and relocate to the open set of holes in the opposite side panel.

NOTE: All gaskets and seals must be in place for sealed combustion applications.

Ensure that the vent fitting is securely attached to the combustion blower using the clamps.

NOTE: The vent fitting **MUST** be installed with the airflow marking arrow pointed toward the vent pipe.

Plug the left drain stub on the vent fitting with the yellow plastic cap.

Remove the pressure switch hose from the upper stub on the plastic transition box.

Relocate the plastic caps on the stubs of the plastic transition from the lower stubs to the upper stubs and secure tightly with the clamps.

Route the pressure switch hose to the lower stub on the plastic transition box. Cut off excess hose and discard. Connect the pressure switch hose to the lower stub on the plastic transition box. Ensure that the hose is routed above the stub on the transition box so that condensate does not collect in the hose. NOTE: Failure to correctly install the pressure switch hose to the transition can adversely affect the safety control operation.

Connect the 3/4" OD rubber hose with the 90° bend to the large drain stub on the condensate trap and secure with a 3/4" clamp.

Route the hose to the drain stub on the bottom of the plastic transition box. Cut off excess hose and discard. Connect the hose to the drain stub on the transition and secure with a $\frac{3}{4}$ " clamp.

Connect the $\frac{5}{8}$ " OD rubber hose with the 90° bend to the right stub on the vent fitting and secure with a $\frac{5}{8}$ " clamp.

Route the hose to the smaller drain stub on the condensate trap. Cut off excess hose and discard. Connect the hose to the drain stub on the trap and secure with a $\frac{5}{8}$ " clamp.

NOTE: Route hoses to the condensate trap with no kinking or binding for proper condensate drainage.

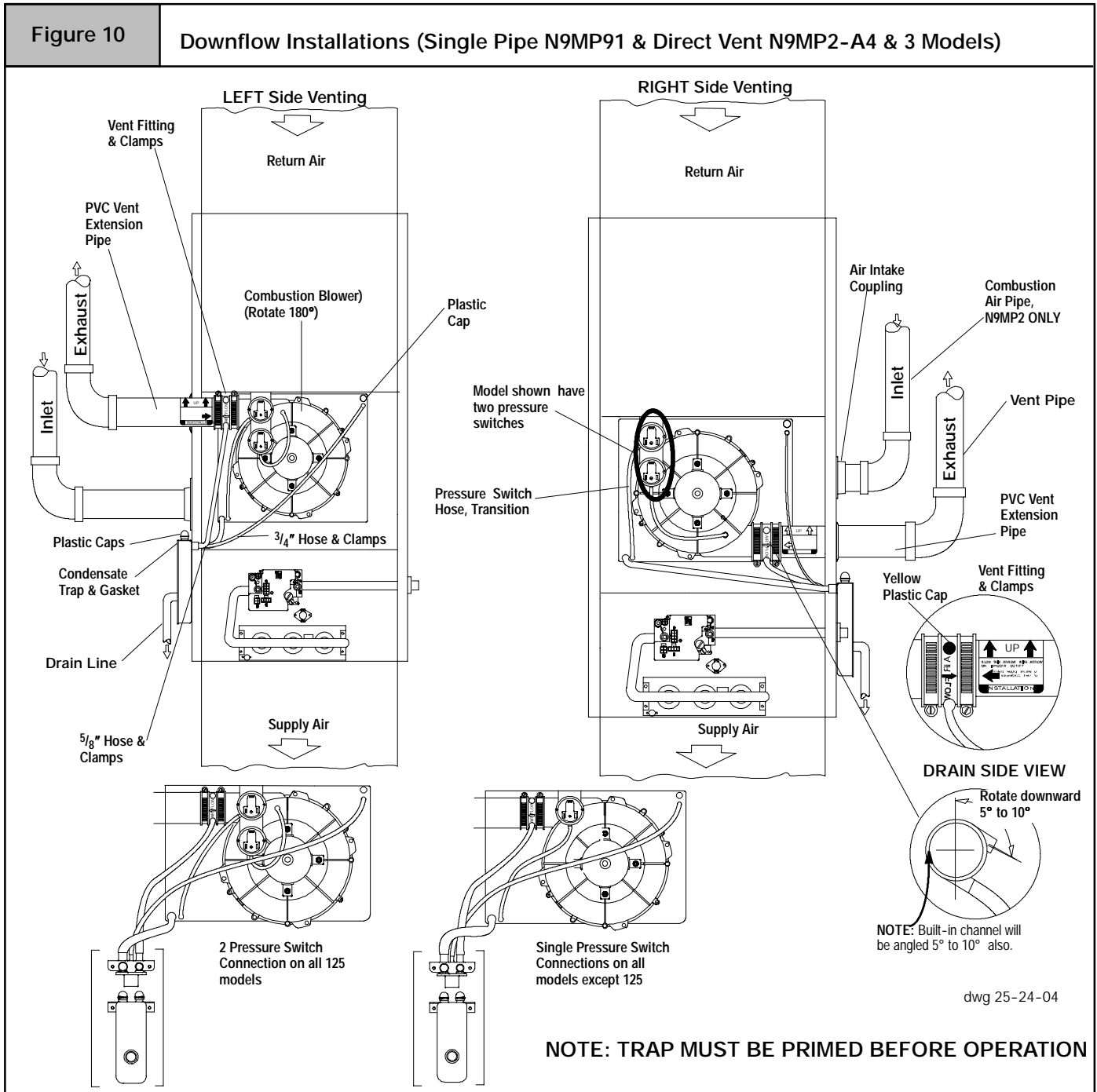

Downflow Installations - (Single Pipe & Direct Vent N9MP1 & N9MP2 Models) (See Figure 10)

NOTE: DO NOT make hose connections until the hose routing and lengths have been determined. Remove the condensate trap and drain hoses from the furnace and secure the drain hoses to the drain stubs on the trap with the hose clamps (position the clamps as shown in **Figure 10**). Install the condensate trap/hose assembly to the furnace casing. Hook one side of the "clamp ears" on the drain stub through the hole in the casing and push the condensate trap into position. Secure with the two screws. Reconnect the drain hoses to the stubs on the vent fitting and the plastic transition and secure with the clamps.

Mount the condensate drain trap in a vertical position to either the right or left side of the furnace using the two screws and gasket that are provided. If needed, remove the hole plugs from the furnace side panel and relocated to the open set of holes in the opposite side panel.

NOTE: All gaskets and seals must be in place for sealed combustion applications.

Ensure that the vent fitting is securely attached to the combustion blower using the rubber coupling and clamps.

Connect the PVC vent extension pipe to the vent fitting. **This pipe has a built-in channel to assist vent condensate disposal.** Align the arrow on the PVC pipe with the airflow marking arrow on the vent fitting. See label on the PVC pipe for proper installation. This pipe may only be shortened if an elbow is used to connect the PVC vent extension tube to field-installed vent pipe. Securely attach the PVC vent extension pipe to the vent fitting with the clamp.

This configuration allows left side venting from the furnace. If right side venting is required, the combustion blower must be relocated on the plastic transition box. Loosen the four(4) screws that secure the blower to the transition approximately $1/2$ ". Rotate the blower 180° and secure with the four(4) screws. Note that some combustion blowers have plastic spacers on the mounting legs of the blower located at the 6 and 12 o'clock positions (blower snout to the left or right) that are required for proper fit up of the blower to the transition. Use caution to not over tighten the screws to prevent stripping out of the plastic mounting holes.

NOTE: The vent fitting **MUST** be installed with the airflow marking arrow pointed toward the vent pipe, with the drain stub at a 5° to 10° downward slope.

Plug the upper drain stub on the vent fitting with the yellow plastic cap.

Connect the PVC vent extension pipe to the vent fitting. **This pipe has a built-in channel to assist vent condensate disposal.** Align the arrow on the PVC pipe with the airflow marking arrow on the vent fitting. See label on the PVC pipe for proper installation. This pipe may only be shortened if an elbow is used to connect the PVC vent extension tube to field-installed vent pipe. Securely attach the PVC vent extension pipe to the vent fitting with the clamp.

Remove the pressure switch hose from the upper stub on the plastic transition box.

Relocate the plastic caps on the stubs of the plastic transition box from the lower stubs to the upper stubs and secure tightly with the clamps.

Route the pressure switch hose to the lower stub on the plastic transition box. Cut off excess hose and discard. Connect the pressure switch hose to the lower stub on the plastic transition box. **NOTE:** Failure to correctly install the pressure switch hose to the transition box can adversely affect the safety control operation.

Connect the $3/4$ " OD rubber hose with the 90° bend to the drain stub on the bottom of the plastic transition box and secure with a $3/4$ " clamp.

Route the hose to the large drain stub on the condensate trap. Cut off excess hose and discard. Connect the hose to the drain stub on the transition and secure with a $3/4$ " clamp.

Connect the $5/8$ " OD rubber hose with the 90° bend to the left drain stub on the vent fitting and secure with a $5/8$ " clamp.

Route the hose to the smaller stub on the condensate trap. Cut off excess hose and discard. Connect the hose to the drain stub on the trap and secure with a $5/8$ " clamp.

For left side or right side mounted condensate trap, the pressure tap on the condensate trap **MUST** be connected to the unused pressure tap located on the top of the plastic transition box. Remove the plastic caps from the pressure tap on the condensate trap

and the plastic transition and connect the $5/16$ " OD rubber hose. (See **Figure 10**)

NOTE: Route hoses to the condensate trap with no kinking or binding for proper condensate drainage.

Connecting Vent and Combustion Air Piping

⚠ WARNING

CARBON MONOXIDE POISONING HAZARD

Failure to properly seal vent piping can result in death, personal injury and/or property damage.

Cement or mechanically seal all joints, fittings, etc. to prevent leakage of flue gases.

Refer to the **Figure 1** through **Figure 10** that corresponds to the installation position of the furnace for the application.

Preassemble the vent and combustion air piping from the furnace to the vent termination. Do not cement the pipe joints until the pipe preassembly process is complete.

Combustion Air Pipe Connection (Dual Certified or Direct Vent)

Install the air intake coupling and gasket to the furnace with the four(4) screws.

Note: The air intake coupling and gasket can be installed to the top panel to the alternate air intake locations on either the left or right side panels of the furnace.

For downflow installation, the air intake coupling and gasket must be installed to the alternate air intake location on either the left or right side panels. Remove the 3" hole plug from the side panel and relocate to the air intake hole in the top panel. Use four screws to seal the four(4) mounting holes in the top panel next to the hole plug. Drill four(4) $7/64$ " diameter holes in the casing using the air intake coupling as the template.

The air intake coupling is sized for 2" PVC pipe.

Install the combustion air pipe to the air intake coupling using RTV sealant to provide for future serviceability.

Vent Pipe Connection

Install the vent pipe grommet to the furnace panel. Locate the grommet in the furnace panel at a location directly away from the vent fitting on the combustion blower. The grommet snaps into the 3" hole plug from the furnace panel. **NOTE:** Depending on the installation position, the vent pipe grommet will be installed to the top panel or to the alternate location on the side panels. If needed, remove the 3" hole plug from the furnace panel and relocate to the open hole in the furnace panel. (See **NO TAG** or **NO TAG**)

Install the vent pipe to the rubber coupling, the vent fitting or the PVC vent extension pipe. Securely attach using the clamp or PVC cement as required.

Note: The vent fitting **MUST** be installed with the air flow marking arrow pointed toward the vent pipe. (See **Figure 11**) Some installations require the vent fitting to be installed with a 5° to 10° downward slope. (See **Figures 8 - 17**)

Figure 11

Proper Sealing Procedure for Combustion Blower

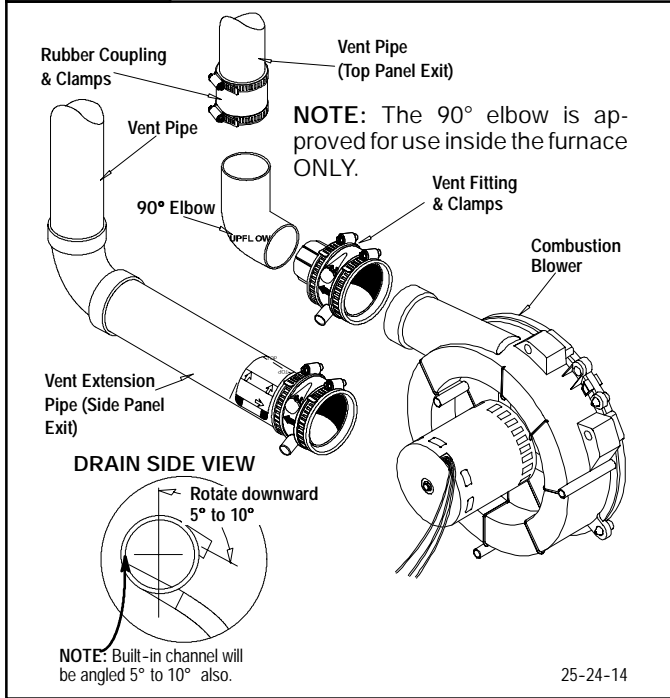

Joining Pipe and Fittings

⚠ WARNING

FIRE HAZARD

Observe all cautions and warnings printed on material containers to prevent possible death, personal injury and/or property damage.

Provide adequate ventilation and do NOT assemble near heat source or open flame. Do NOT smoke while using solvent cements and avoid contact with skin or eyes.

This furnace is approved for venting with Schedule 40 PVC, CPVC, ABS, Cellular Core pipe fittings and SDR-26 PVC.

NOTE: All PVC, CPVC, ABS, and Cellular Core pipe fittings, solvent cement, primers and procedures **MUST** conform to American National Standard Institute and American Society for Testing and Materials (ANSI/ASTM) standards.

- *Pipe and Fittings* - ASTM D1785, D2241, D2466, D2661, D2665, F-891, F-628
- *PVC Primer and Solvent Cement* - ASTM D2564
- *Procedure for Cementing Joints* - Ref ASTM D2855

NOTE: In order to create a seal that allows future removal of pipe, **RTV sealant MUST be used on the inlet pipe** where it joins to the furnace. PVC, CPVC, ABS, and Cellular Core pipe and cement may be used on all other joints.

CAUTION

Do NOT use solvent cement that has become curdled, lumpy or thickened and do NOT thin. Observe precautions printed on containers. For applications below 32° F., use only low temperature type solvent cement.

1. Cut pipe end square, remove ragged edges and burrs. Chamfer end of pipe, then clean fitting, socket and pipe joint of all dirt, grease, or moisture.

NOTE: Stir the solvent cement frequently while using. Use a natural bristle brush or the dauber supplied with the cement. The proper brush size is one inch.

2. After checking pipe and socket for proper fit, wipe socket and pipe with cleaner-primer. Apply a liberal coat of primer to inside surface of socket and outside of pipe. Do NOT allow primer to dry before applying cement.
3. Apply a thin coat of cement evenly in the socket. Quickly apply a heavy coat of cement to the pipe end and insert pipe into fittings with a slight twisting movement until it bottoms out.

NOTE: Cement **MUST** be fluid while inserting pipe. If **NOT**, recoat pipe.

4. Hold the pipe in the fitting for 30 seconds to prevent the tapered socket from pushing the pipe out of the fitting.
5. Wipe all excess cement from the joint with a rag. Allow 15 minutes before handling. Cure time varies according to fit, temperature and humidity.

A2 Changes Multi Position 90+ Furnaces

Figure 12

Upflow Installations (Dual Certified *9MPD, *9MPT & *9MPV-A2 Models)

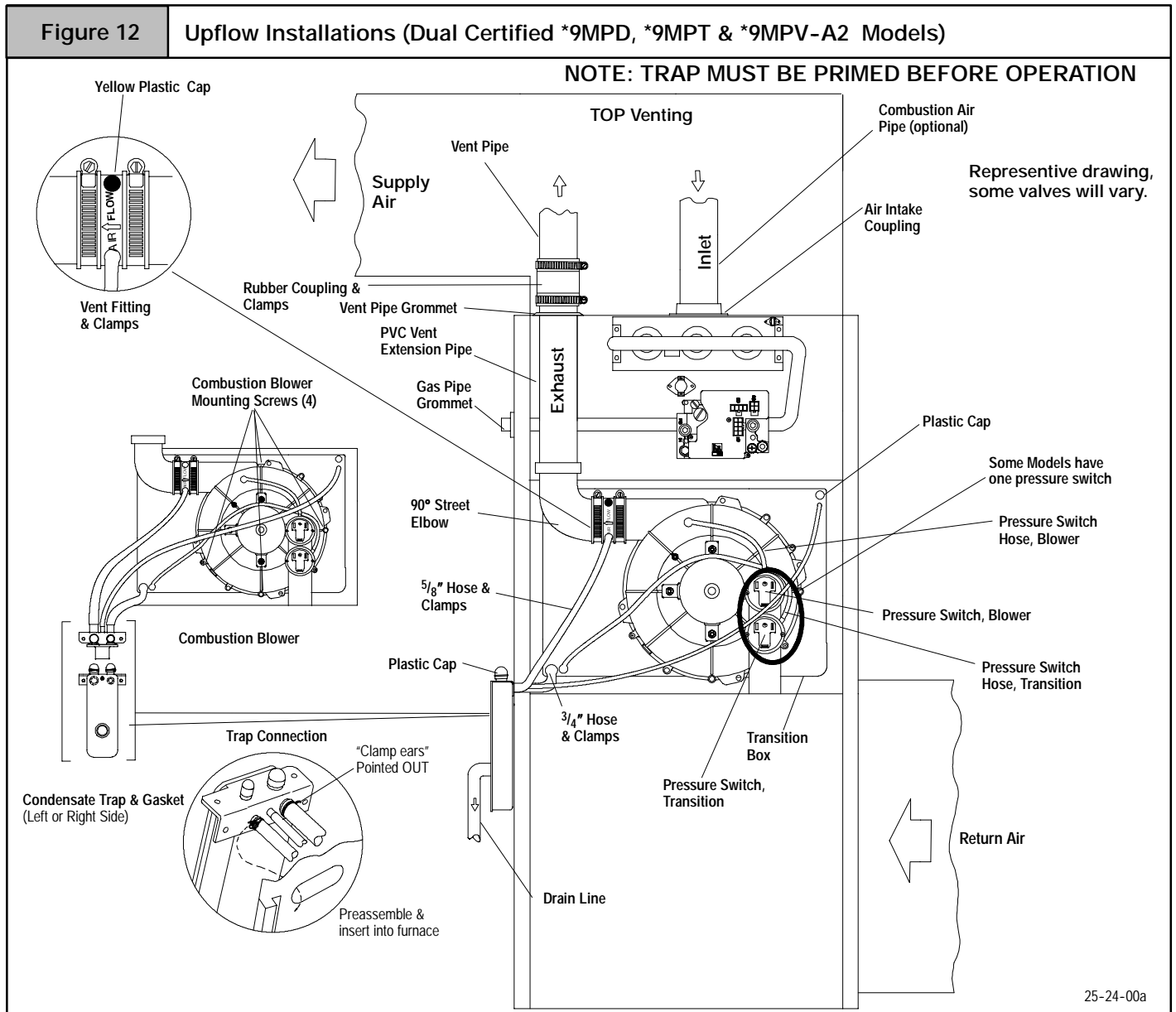

Upflow Installations - (Dual Certified *9MPD, *9MPT & *9MPV)(See Figure 12)

NOTE: DO NOT make connections until the hose routing and lengths have been determined. Remove the condensate trap and drain hoses from the furnace and secure the drain hoses to the drain stubs on the trap with the hose clamps (position the clamps as shown in **Figure 12**). Install the condensate trap/hose assembly to the furnace casing. Hook one side of the "clamp ears" on the drain stub through the hole in the casing and push the condensate trap into position. Secure with the two screws. Reconnect the drain hoses to the stubs on the vent fitting and the plastic transition and secure with the clamps.

Mount the condensate drain trap in a vertical position to either the left or right side of the furnace using the two screws and gasket that are provided. If needed, remove the hole plugs from the furnace side panel and relocate to the open set of holes in the opposite side panel.

NOTE: All gaskets and seals must be in place for sealed combustion applications.

Ensure that the vent fitting and the 90° street elbow are securely attached to the combustion blower using the clamps.

Plug the upper drain stub on the vent fitting with the yellow plastic cap.

Glue the PVC vent extension pipe to the 90° street elbow after checking the fit up. (Follow the procedures outlined in the *Joining Pipe and Fittings* section of this manual, page 13.) Disregard the instruction label on the PVC vent extension pipe. The orientation of the supplied PVC vent extension pipe is not critical in the vertical position. The PVC pipe will extend through the top panel about 2 1/2". Connect the rubber coupling to the end of the PVC extension pipe using the clamp.

NOTE: There will be some misalignment of the PVC pipe inside the furnace. The rubber coupling will straighten out the misalignment at the vent pipe connection at the top of the furnace.

For left side venting, remove 90° street elbow from the vent fitting by loosening the clamp on the vent fitting. Securely attach vent fitting to combustion blower.

NOTE: For left side venting, the vent fitting **MUST** be installed with the airflow marking arrow pointed toward the vent pipe, with the drain stub at a 5° to 10° downward slope.

Connect the PVC vent extension pipe to the vent fitting. **This pipe has a built-in channel to assist vent condensate disposal.** Align the arrow on the PVC pipe with the airflow marking arrow on the vent fitting. See label on the PVC pipe for proper installation. This pipe may only be shortened if an elbow is used to connect the

25-24-00a

PVC vent extension tube to field-installed vent pipe. Securely attach the PVC vent extension pipe to the vent fitting with the clamp.

This configuration allows left side venting from the furnace. If right side venting is required, the combustion blower must be relocated on the plastic transition box. Loosen the four(4) screws that secure the blower to the transition approximately $\frac{1}{2}$ ". Rotate the blower 180° and secure with the four(4) screws. Note that some combustion blowers have plastic spacers on the mounting legs of the blower located at the 6 and 12 o'clock positions (blower snout to the left or right) that are required for proper fit up of the blower to the transition. Use caution to not over tighten the screws to prevent stripping out of the plastic mounting holes.

NOTE: For right side venting, the vent fitting MUST be installed with the airflow marking arrow pointed toward the vent pipe, with the drain stub at a 5° to 10° downward slope. (See Figure 13)

Plug the upper drain stub on the vent fitting with the yellow plastic cap.

Connect the PVC vent extension pipe to the vent fitting. **This pipe has a built-in channel to assist vent condensate disposal.**

Align the arrow on the PVC pipe with the airflow marking arrow on the vent fitting. See label on the PVC pipe for proper installation. This pipe may only be shortened if an elbow is used to connect the PVC vent extension tube to field-installed vent pipe. Securely attach the PVC vent extension pipe to the vent fitting with the clamp.

For left side mounted condensate trap, connect the $\frac{3}{4}$ " OD rubber hose with the 90° bend to the large drain stub on the condensate trap and secure with a $\frac{3}{4}$ " clamp.

Route the hose to the drain stub on the bottom of the plastic transition box. Cut off excess hose and discard. Connect the hose to the drain stub on the transition and secure with a $\frac{3}{4}$ " clamp.

For right side mounted condensate trap, connect the $\frac{3}{4}$ " OD rubber hose with the 90° bend to the bottom of the plastic transition box and secure with a $\frac{3}{4}$ " clamp.

Route the hose to the large drain stub on the condensate trap. Cut off excess hose and discard. Connect the hose to the drain stub on the condensate trap and secure with a $\frac{3}{4}$ " clamp.

Connect the $\frac{5}{8}$ " OD rubber hose with the 90° bend to the lower drain stub on the vent fitting and secure with a $\frac{5}{8}$ " clamp.

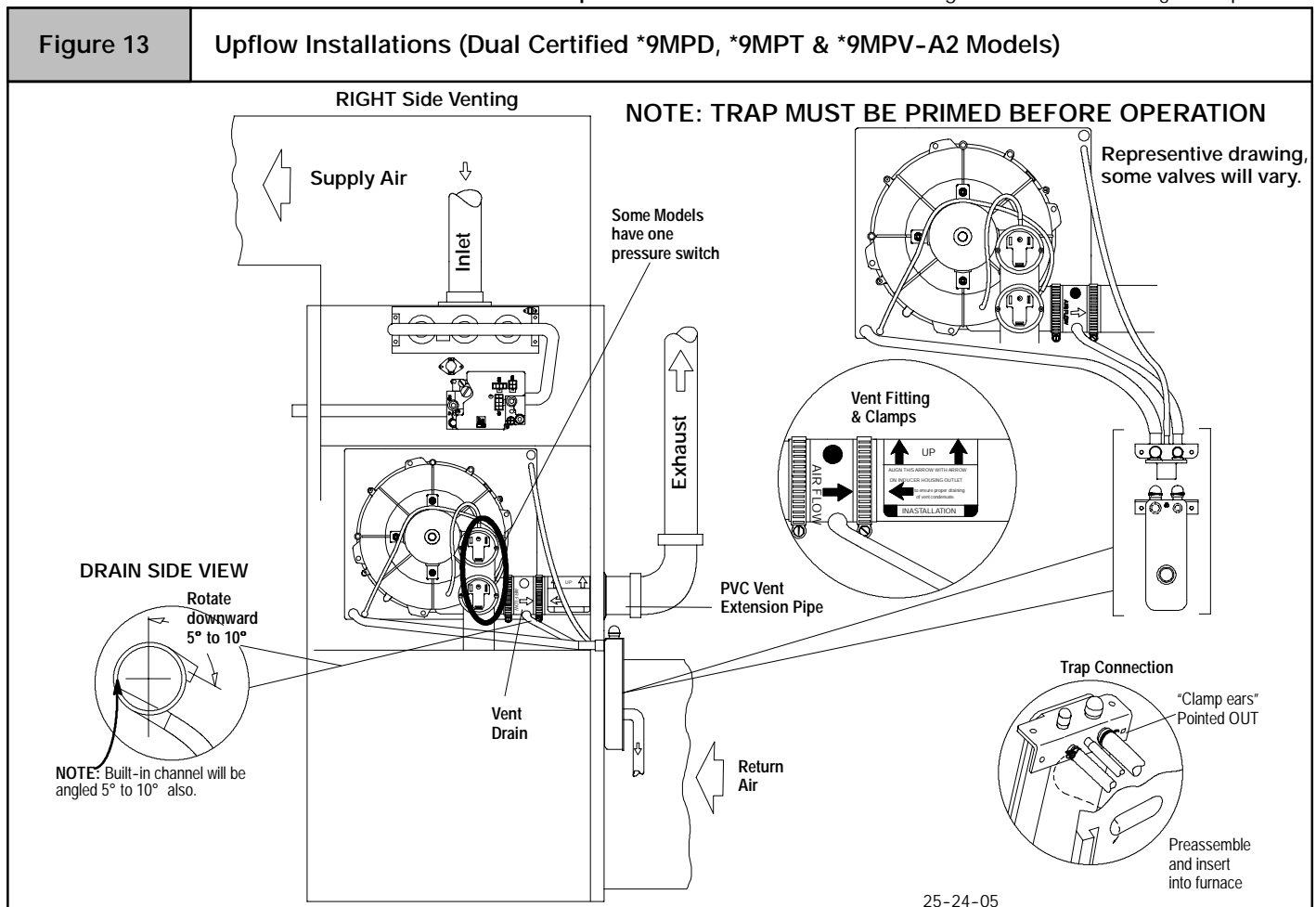

For left or right side mounted condensate trap, the pressure tap on the condensate trap MUST be connected to the unused pressure tap located on the upper right hand corner of the plastic transition box. Remove the plastic caps from the pressure taps on the condensate trap and the plastic transition and connect with the $\frac{5}{16}$ " OD rubber hose. (See Figure 12 and Figure 13)

Route the hose to the small drain stub on the condensate trap. Cut off excess hose and discard. Connect the hose to the drain stub on the trap and secure with a $\frac{5}{8}$ " clamp.

NOTE: Route hoses to the condensate trap with no kinking or binding for proper condensate drainage.

Figure 14

Horizontal Left Installations (Dual Certified *9MPD,*9MPT,*9MPV-A2 Models)

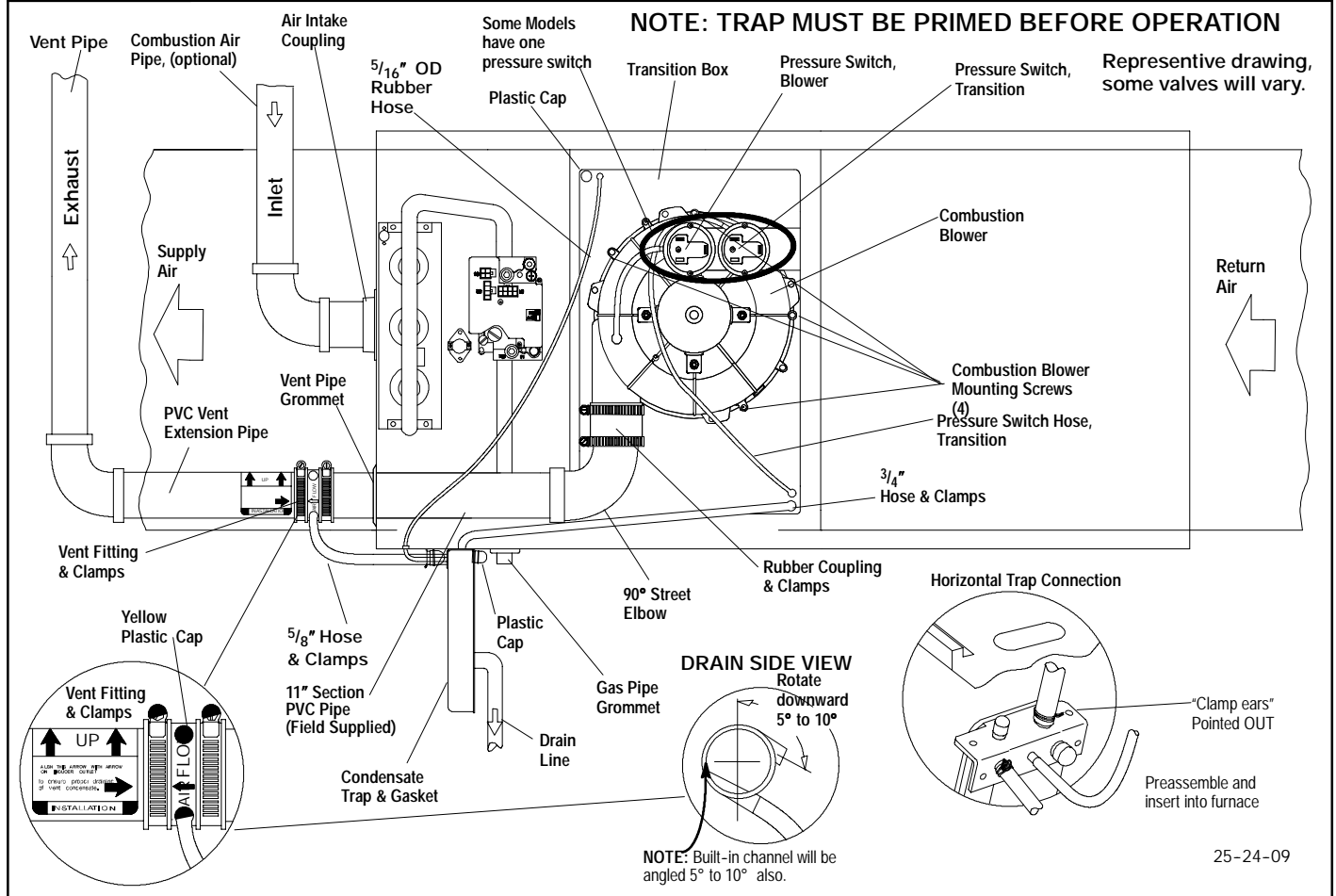

Horizontal Left Installations - (Dual Certified *9MPD, *9MPT & *9MPV) (See Figure 14)

Note: DO NOT make hose connections until the hose routing and lengths have been determined. Remove the condensate trap and drain hoses from the furnace and secure the drain hoses to the drain stubs on the trap with the hose clamps (position the clamps as shown in **Figure 14**). Install the condensate trap/hose assembly to the furnace casing. Hook one side of the "clamp ears" on the drain stub through the hole in the casing and push the condensate trap into position. Secure with the two screws. Reconnect the drain hoses to the stubs on the vent fitting and the plastic transition and secure with the clamps.

Relocate the plastic cap and clamp from the vertical transition drain stub to the horizontal transition drain stub on the condensate drain trap. Secure the clamps tightly to prevent condensate leakage. Do not change the cap and clamp on the vent drain stub.

Mount the condensate drain trap in a vertical position to the left side of the furnace using the two screws and gasket that are provided. Note: The condensate trap will be located under the furnace in a vertical position when the furnace is placed horizontally on the left side. If needed, remove the hole plugs from the furnace side panel and relocate to the open set of holes in the opposite side panel.

NOTE: All gaskets and seals must be in place for sealed combustion applications.

Remove the 90° street elbow and vent fitting from the combustion blower by loosening the clamps on the vent fitting. Connect the 90° street elbow to the combustion blower using the rubber coupling and clamps. Glue a 11" section of PVC pipe (field supplied) to the 90° street elbow after checking the fit up. (Follow the procedures outlined in the *Joining Pipe and Fittings* section of this manual, page 13.) The PVC pipe will extend through the top panel about

1 1/2". Connect the vent fitting to the end of the 11" section of PVC pipe using the clamp.

NOTE: The vent fitting **MUST** be installed with the airflow marking arrow pointed toward the vent pipe, with the drain stub at a 5° to 10° downward slope.

Plug the upper drain stub on the vent fitting with the yellow plastic cap.

Connect the PVC vent extension pipe to the vent fitting. **This pipe has a built-in channel to assist vent condensate disposal.** Align the arrow on the PVC pipe with the airflow marking arrow on the vent fitting. See label on the PVC pipe for proper installation. This pipe may only be shortened if an elbow is used to connect the PVC vent extension tube to field-installed vent pipe. Securely attach the PVC vent extension pipe to the vent fitting with the clamp.

Connect the 5/8" OD rubber hose with the 90° bend to the lower drain stub on the vent fitting and secure with a 5/8" clamp.

Route the hose to the horizontal drain stub on the condensate trap. Cut off excess hoses and discard. Connect the hose to the drain stub on the condensate trap and secure with a 5/8" clamp.

Connect the 3/4" OD rubber hose with the 90° bend to the large drain stub on the condensate trap and secure with a 3/4" clamp.

Route the hose to the drain stub on the bottom of the plastic transition box. Cut off excess hose and discard. Connect the hose to the drain stub on the transition and secure with a 3/4" clamp.

The pressure tap on the condensate trap **MUST** be connected to the unused pressure tap located on the top of the plastic transition box. Remove the plastic caps from the pressure taps on the con-

densate trap and the plastic transition and connect with the $\frac{5}{16}$ " OD rubber hose.

NOTE: This will require drilling a $\frac{5}{16}$ " OD hole in the furnace casing next to the condensate trap.

NOTE: Ensure hoses maintain a downward slope to the condensate trap with no kinking or binding for proper condensate drainage.

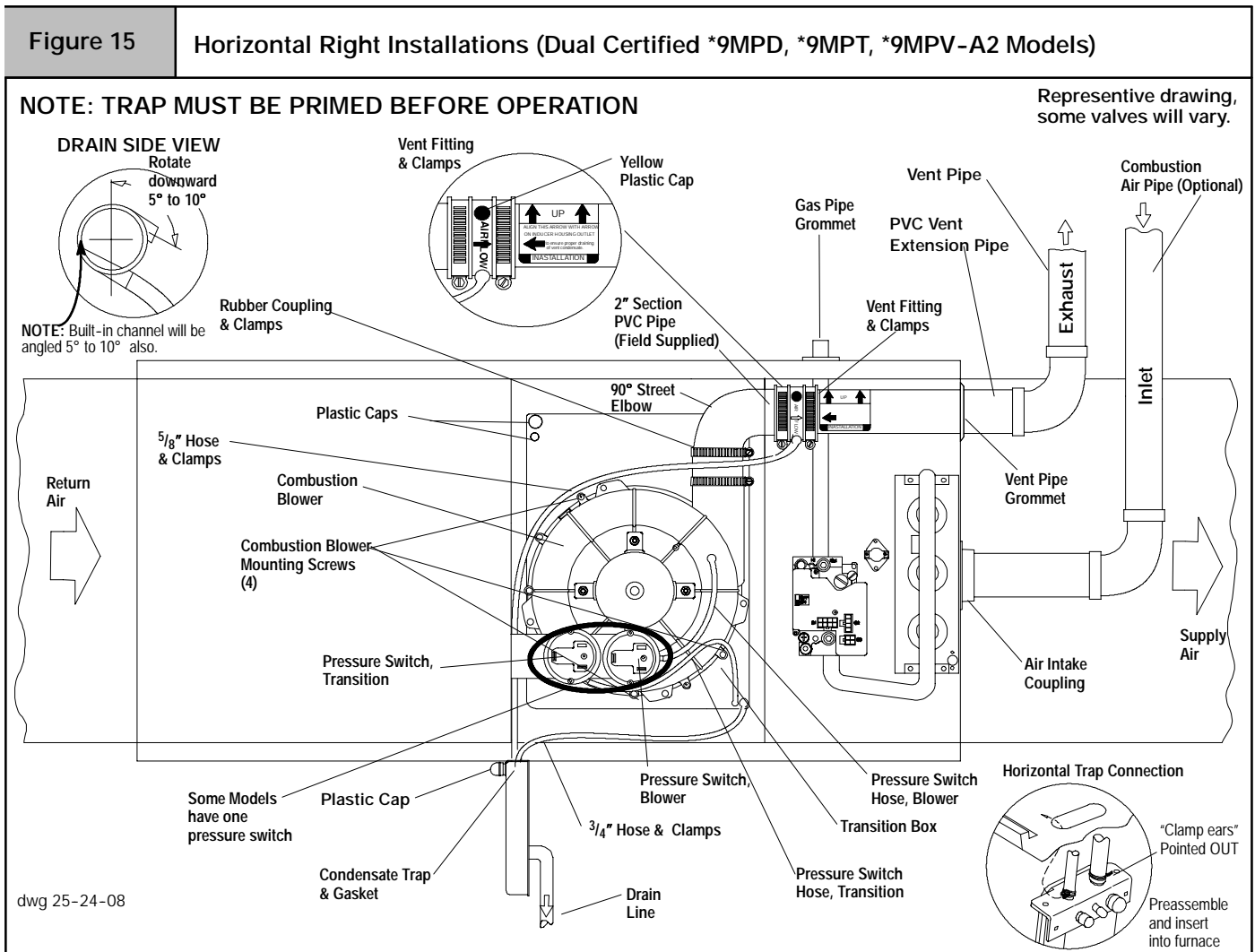

Horizontal Right Installations - (Dual Certified *9MPD, *9MPT, *9MPV) (See Figure 15)

Note: DO NOT make hose connections until the hose routing and lengths have been determined. Remove the condensate trap and drain hoses from the furnace and secure the drain hoses to the drain stubs on the trap with the hose clamps (position the clamps as shown in **Figure 15**). Install the condensate trap/hose assembly to the furnace casing. Hook one side of the "clamp ears" on the drain stub through the hole in the casing and push the condensate trap into position. Secure with the two screws. Reconnect the drain hoses to the stubs on the vent fitting and the plastic transition and secure with the clamps.

Relocate the plastic caps and clamps on the condensate drain trap from the vertical drain stub to the horizontal drain stubs. Secure the clamps tightly to prevent condensate leakage.

Mount the condensate drain trap in a vertical position to the right side of the furnace using the two screws and gasket that are provided. Note: The condensate trap will be located under the furnace in a vertical position when the furnace is placed horizontally on the right side. If needed, remove the hole plugs from the furnace side panel and relocated to the open set of holes in the opposite side panel.

NOTE: All gaskets and seals must be in place for sealed combustion applications.

Remove the 90° street elbow and vent fitting from the combustion blower by loosening the clamps on the vent fitting. Connect the 90° street elbow to the combustion blower using the rubber coupling and clamps. Cut a 2" section of PVC pipe (field supplied). Glue the 2" section of PVC pipe to the 90° street elbow after checking the fit up. (Follow the procedures outlined in the *Joining Pipe and Fittings* section of this manual, page 13.) Connect the vent fitting to the end of the 2" section of PVC pipe using the clamp.

NOTE: The vent fitting MUST be installed with the airflow marking arrow pointed toward the vent pipe, with the drain stub at a 5° to 10° downward slope.

Plug the upper drain stub on the vent fitting with the yellow plastic cap.

Connect the PVC vent extension pipe to the vent fitting. **This pipe has a built-in channel to assist vent condensate disposal.** Align the arrow on the PVC pipe with the airflow marking arrow on the vent fitting. See label on the PVC pipe for proper installation. This pipe may only be shortened if an elbow is used to connect the PVC vent extension tube to field-installed vent pipe. Securely attach the PVC vent extension pipe to the vent fitting with the clamp.

Remove the pressure switch hose from the upper stub on the plastic transition box.

Relocate the plastic caps on the stubs of the plastic transition box from the lower stubs to the upper stubs and secure tightly with the clamps.

Route the pressure switch hose to the lower stub on the plastic transition box. Cut off excess hose and discard. Connect the pressure switch hose to the lower stub on the plastic transition box. Ensure that the hose is routed above the stub on the transition box so that condensate does not collect in the hose. NOTE: Failure to correctly install the pressure switch hose to the transition can adversely affect the safety control operation.

Connect the 3/4" OD rubber hose with the 90° bend to the large

drain stub on the condensate trap and secure with a 3/4" clamp.

Route the hose to the drain stub on the bottom of the plastic transition box. Cut off excess hose and discard. Connect the hose to the drain stub on the transition and secure with a 3/4" clamp.

Connect the 5/8" OD rubber hose with the 90° bend to the lower drain stub on the vent fitting and secure with a 5/8" clamp.

Route the hose to the smaller drain stub on the condensate trap. Cut off excess hose and discard. Connect the hose to the drain stub on the trap and secure with a 5/8" clamp.

NOTE: Route hoses to the condensate trap with no kinking or binding for proper condensate drainage.

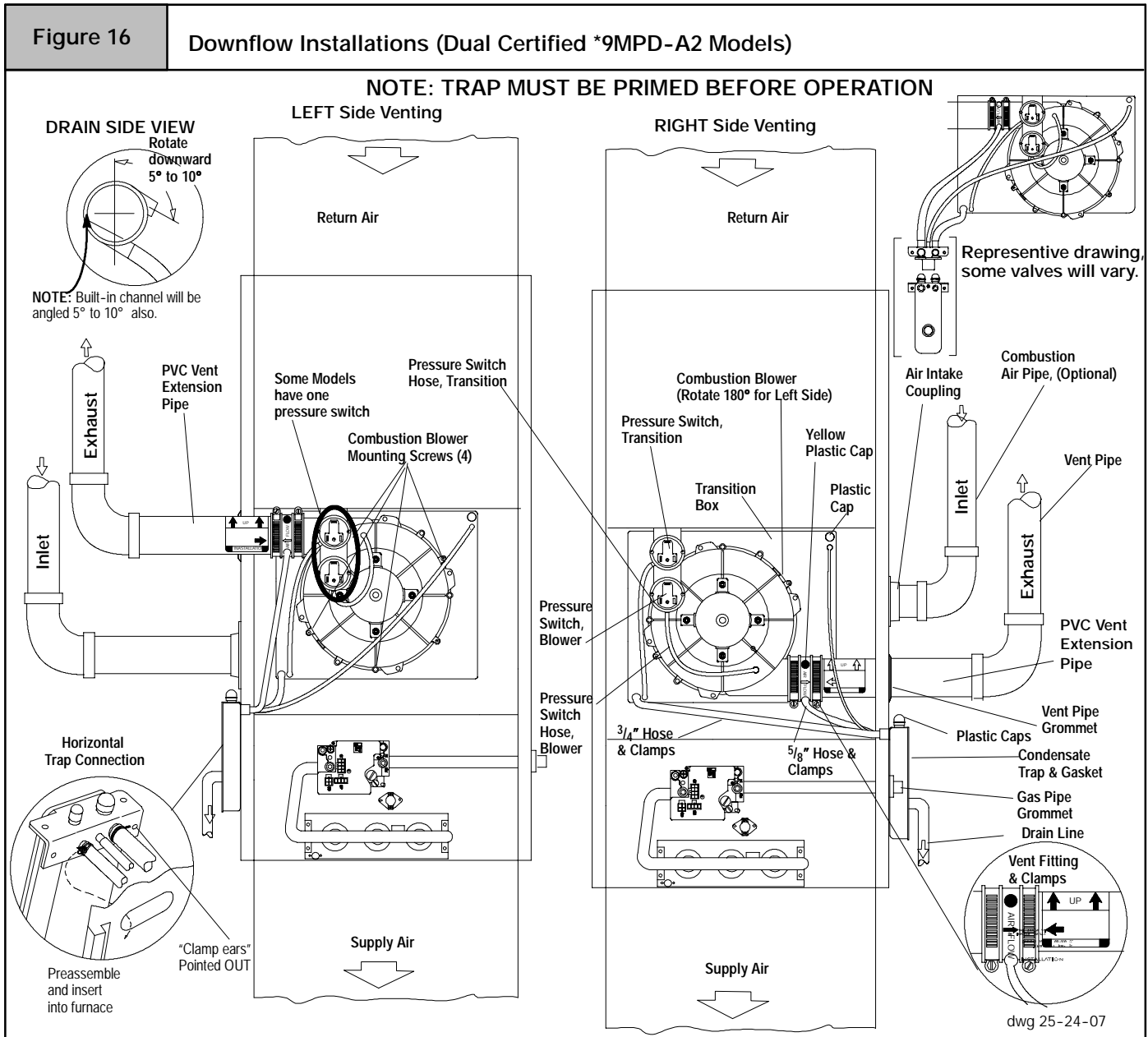

Downflow Installations - (Dual Certified *9MPD, *9MPT, *9MPV Models) (See Figure 16)

NOTE: DO NOT make hose connections until the hose routing and lengths have been determined. Remove the condensate trap and drain hoses from the furnace and secure the drain hoses to the drain stubs on the trap with the hose clamps (position the clamps as shown in Figure 16). Install the condensate trap/hose assembly to the furnace casing. Hook one side of the "clamp ears" on the drain stub through the hole in the casing and push the condensate trap into position. Secure with the two screws. Reconnect the drain

hoses to the stubs on the vent fitting and the plastic transition and secure with the clamps.

Mount the condensate drain trap in a vertical position to either the right or left side of the furnace using the two screws and gasket that are provided. If needed, remove the hole plugs from the furnace side panel and relocated to the open set of holes in the opposite side panel.

NOTE: All gaskets and seals must be in place for sealed combustion applications.

For both right and left side vent, remove the 90° street elbow from the vent fitting by loosening the clamp on the vent fitting.

Ensure that the vent fitting is securely attached to the combustion blower using the rubber coupling and clamps.

Connect the PVC vent extension pipe to the vent fitting. **This pipe has a built-in channel to assist vent condensate disposal.** Align the arrow on the PVC pipe with the airflow marking arrow on the vent fitting. See label on the PVC pipe for proper installation. This pipe may only be shortened if an elbow is used to connect the PVC vent extension tube to field-installed vent pipe. Securely attach the PVC vent extension pipe to the vent fitting with the clamp.

This configuration allows left side venting from the furnace. If right side venting is required, the combustion blower must be relocated on the plastic transition box. Loosen the four(4) screws that secure the blower to the transition approximately $1/2$ ". Rotate the blower 180° and secure with the four(4) screws. Note that some combustion blowers have plastic spacers on the mounting legs of the blower located at the 6 and 12 o'clock positions (blower snout to the left or right) that are required for proper fit up of the blower to the transition. Use caution to not over tighten the screws to prevent stripping out of the plastic mounting holes.

NOTE: The vent fitting **MUST** be installed with the airflow marking arrow pointed toward the vent pipe, with the drain stub at a 5° to 10° downward slope.

Plug the upper drain stub on the vent fitting with the yellow plastic cap.

Connect the PVC vent extension pipe to the vent fitting. **This pipe has a built-in channel to assist vent condensate disposal.** Align the arrow on the PVC pipe with the airflow marking arrow on the vent fitting. See label on the PVC pipe for proper installation.

This pipe may only be shortened if an elbow is used to connect the PVC vent extension tube to field-installed vent pipe. Securely attach the PVC vent extension pipe to the vent fitting with the clamp.

Remove the pressure switch hose from the upper stub on the plastic transition box.

Relocate the plastic caps on the stubs of the plastic transition box from the lower stubs to the upper stubs and secure tightly with the clamps.

Route the pressure switch hose to the lower stub on the plastic transition box. Cut off excess hose and discard. Connect the pressure switch hose to the lower stub on the plastic transition box. **NOTE:** Failure to correctly install the pressure switch hose to the transition box can adversely affect the safety control operation.

Connect the $3/4$ " OD rubber hose with the 90° bend to the drain stub on the bottom of the plastic transition box and secure with a $3/4$ " clamp.

Route the hose to the large drain stub on the condensate trap. Cut off excess hose and discard. Connect the hose to the drain stub on the transition and secure with a $3/4$ " clamp.

Connect the $5/8$ " OD rubber hose with the 90° bend to the lower drain stub on the vent fitting and secure with a $5/8$ " clamp.

Route the hose to the smaller stub on the condensate trap. Cut off excess hose and discard. Connect the hose to the drain stub on the trap and secure with a $5/8$ " clamp.

For left side or right side mounted condensate trap, the pressure tap on the condensate trap **MUST** be connected to the unused pressure tap located on the top of the plastic transition box. Remove the plastic caps from the pressure tap on the condensate trap and the plastic transition and connect the $5/16$ " OD rubber hose. (See **Figure 16**)

NOTE: Route hoses to the condensate trap with no kinking or binding for proper condensate drainage.

Figure 17

Upflow Installations (Single Pipe & Direct Vent N9MP1 & N9MP2-A2 Models)

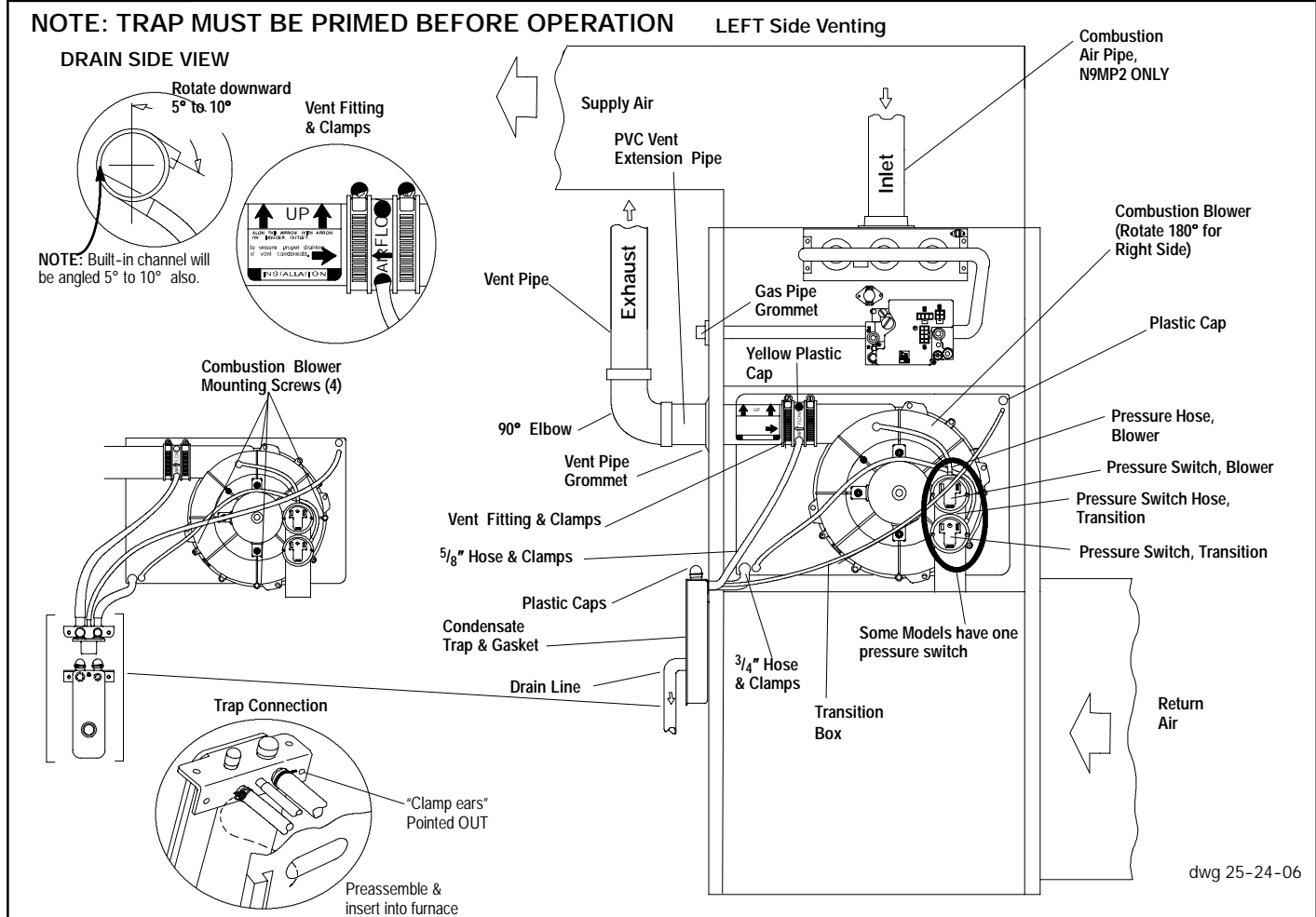

Upflow Installations - (Single Pipe & Direct Vent N9MP1 & N9MP2 Models) (See Figure 17)

NOTE: DO NOT make hose connections until the hose routing and lengths have been determined. Remove the condensate trap and drain hoses from the furnace and secure the drain hoses to the drain stubs on the trap with the hose clamps (position the clamps as shown in **Figure 17**). Install the condensate trap/hose assembly to the furnace casing. Hook one side of the "clamp ears" on the drain stub through the hole in the casing and push the condensate trap into position. Secure with the two screws. Reconnect the drain hoses to the stubs on the vent fitting and the plastic transition and secure with the clamps.

Mount the condensate drain trap in a vertical position to either the left or right side of the furnace using the two screws and gasket that are provided. If needed, remove the hole plugs from the furnace side panel and relocate to the open set of holes in the opposite side panel.

NOTE: All gaskets and seals must be in place for sealed combustion applications.

Ensure that the vent fitting is securely attached to the combustion blower using the rubber coupling and clamps.

NOTE: For left side venting, the vent fitting **MUST** be installed with the airflow marking arrow pointed toward the vent pipe, with the drain stub at a 5° to 10° downward slope.

Connect the PVC vent extension pipe to the vent fitting. **This pipe has a built-in channel to assist vent condensate disposal.** Align the arrow on the PVC pipe with the airflow marking arrow on

the vent fitting. See label on the PVC pipe for proper installation. This pipe may only be shortened if an elbow is used to connect the PVC vent extension tube to field-installed vent pipe. Securely attach the PVC vent extension pipe to the vent fitting with the clamp.

This configuration allows left side venting from the furnace. If right side venting is required, the combustion blower must be relocated on the plastic transition box. Loosen the four(4) screws that secure the blower to the transition approximately 1/2". Rotate the blower 180° and secure with the four(4) screws. Note that some combustion blowers have plastic spacers on the mounting legs of the blower located at the 6 and 12 o'clock positions (blower snout to the left or right) that are required for proper fit up of the blower to the transition. Use caution to not over tighten the screws to prevent stripping out of the plastic mounting holes.

NOTE: For right side venting, the vent fitting **MUST** be installed with the airflow marking arrow pointed toward the vent pipe, with the drain stub at a 5° to 10° downward slope. (See **Figure 18**)

Plug the upper drain stub on the vent fitting with the yellow plastic cap.

Connect the PVC vent extension pipe to the vent fitting. **This pipe has a built-in channel to assist vent condensate disposal.** Align the arrow on the PVC pipe with the airflow marking arrow on the vent fitting. See label on the PVC pipe for proper installation. This pipe may only be shortened if an elbow is used to connect the PVC vent extension tube to field-installed vent pipe. Securely attach the PVC vent extension pipe to the vent fitting with the clamp.

For left side mounted condensate trap, connect the $\frac{3}{4}$ " OD rubber hose with the 90° bend to the large drain stub on the condensate trap and secure with a $\frac{3}{4}$ " clamp.

Route the hose to the drain stub on the bottom of the plastic transition box. Cut off excess hose and discard. Connect the hose to the drain stub on the transition and secure with a $\frac{3}{4}$ " clamp.

For right side mounted condensate trap, connect the $\frac{3}{4}$ " OD rubber hose with the 90° bend to the bottom of the plastic transition box and secure with a $\frac{3}{4}$ " clamp.

Route the hose to the large drain stub on the condensate pump. Cut off excess hose and discard. Connect the hose to the drain stub on the condensate trap and secure with a $\frac{3}{4}$ " clamp.

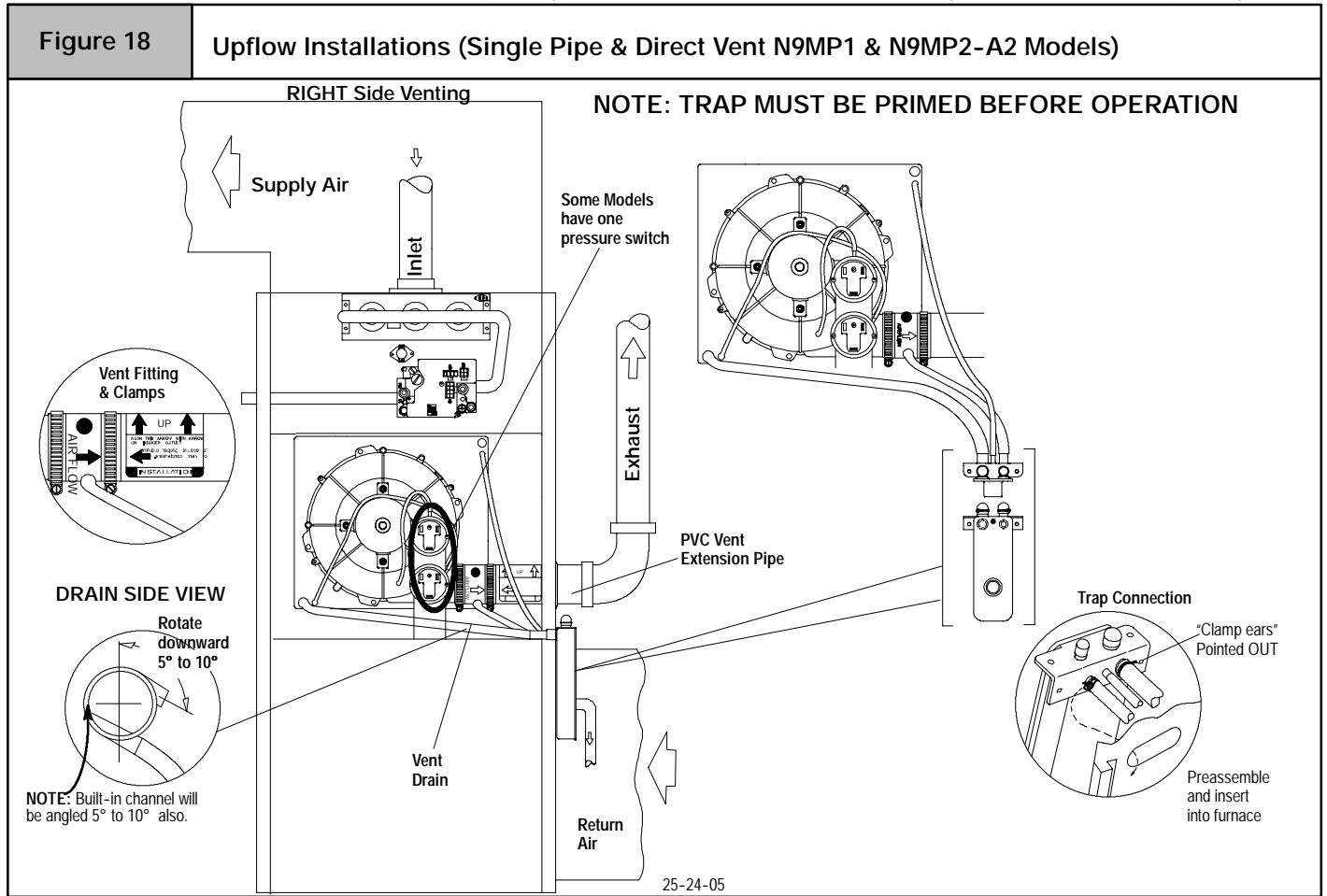

For left side or right side mounted condensate trap, the pressure tap on the condensate trap MUST be connected to the unused pressure tap located on the upper right hand corner of the plastic transition box. Remove the plastic caps from the pressure taps on the condensate trap and the plastic transition and connect with the $\frac{5}{16}$ " OD rubber hose. (See **Figure 17** and **Figure 18**)

Connect the $\frac{5}{8}$ " OD rubber hose with the 90° bend to the lower

drain stub on the vent fitting and secure with a $\frac{5}{8}$ " clamp.

Route the hose to the smaller drain stub on the condensate trap. Cut off excess hose and discard. Connect the hose to the drain stub on the trap and secure with a $\frac{5}{8}$ " clamp.

NOTE: Route hoses to the condensate trap with no kinking or binding for proper condensate drainage.

Figure 19

Horizontal Left Installations (Single Pipe & Direct Vent N9MP1 & N9MP2-A2 Models)

NOTE: TRAP MUST BE PRIMED BEFORE OPERATION

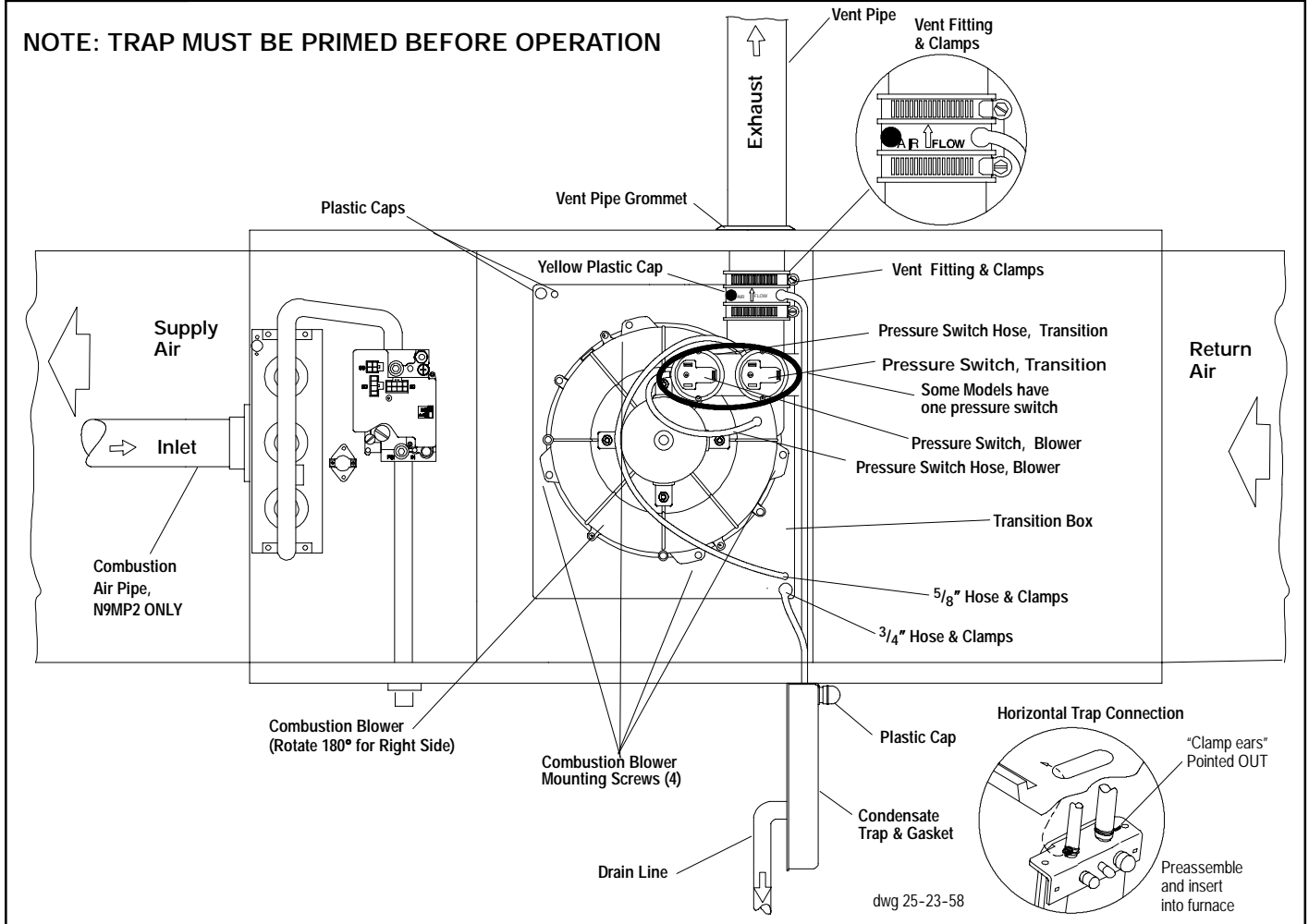

Horizontal Left Installations - (Single Pipe & Direct Vent N9MP1 & N9MP2 Models) (See Figure 19)

NOTE: DO NOT make hose connections until the hose routing and lengths have been determined. Remove the condensate trap and drain hoses from the furnace and secure the drain hoses to the drain stubs on the trap with the hose clamps (position the clamps as shown in **Figure 19**). Install the condensate trap/hose assembly to the furnace casing. Hook one side of the "clamp ears" on the drain stub through the hole in the casing and push the condensate trap into position. Secure with the two screws. Reconnect the drain hoses to the stubs on the vent fitting and the plastic transition and secure with the clamps.

Relocate the plastic caps and clamps on the condensate drain trap from the vertical drain stubs to the horizontal drain stubs. Secure the clamps tightly to prevent condensate leakage.

Mount the condensate drain trap in a vertical position to the left side of the furnace using the two screws and gasket that are provided. Note: The condensate trap will be located under the furnace in a vertical position when the furnace is placed horizontally on the left side. If needed, remove the hole plugs from the furnace side panel and relocate to the open set of holes in the opposite side panel.

NOTE: All gaskets and seals must be in place for sealed combustion applications.

Relocate the combustion blower on the plastic transition box. Remove the four(4) screws that secure the blower to the transition

box. Rotate the blower 180° so the blower snout is pointing up and secure with the four(4) screws. Use caution to not over tighten the screws to prevent stripping out of the plastic mounting holes.

Ensure that the vent fitting is securely attached to the combustion blower using the rubber coupling and clamps.

NOTE: The vent fitting **MUST** be installed with the airflow marking arrow pointed toward the vent pipe.

Plug the left drain stub on the vent fitting with the yellow plastic cap.

Connect the 3/4" OD rubber hose with the 90° bend to the large drain stub on the condensate trap and secure with a 3/4" clamp.

Route the hose to the drain stub on the bottom of the plastic transition box. Cut off excess hose and discard. Connect the hose to the drain stub on the transition and secure with a 3/4" clamp.

Connect the 5/8" OD rubber hose with the 90° bend to the right drain stub on the vent fitting and secure with a 5/8" clamp.

Route the hose to the smaller drain stub on the condensate trap. Cut off excess hose and discard. Connect the hose to the drain stub on the vent fitting and secure with a 5/8" clamp.

NOTE: Route hoses to the condensate trap with no kinking or binding for proper condensate drainage.

Figure 20

Horizontal Right Installations (Single Pipe & Direct Vent N9MP1 & N9MP2-A2 Models)

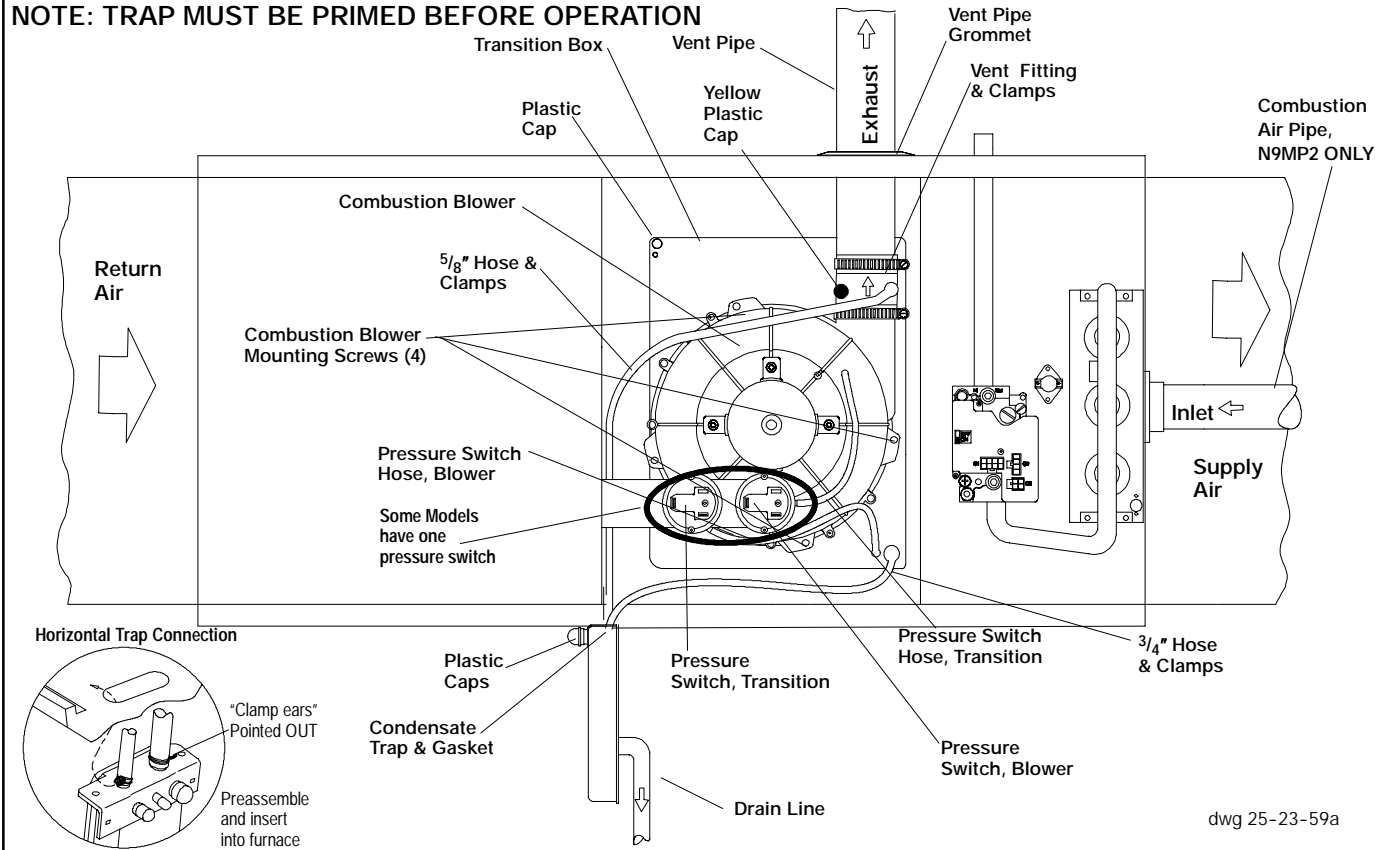
NOTE: TRAP MUST BE PRIMED BEFORE OPERATION

dwg 25-23-59a

Horizontal Right Installations - (Single Pipe & Direct Vent N9MP1 & N9MP2 Models) (See Figure 20)

NOTE: DO NOT make hose connections until the hose routing and lengths have been determined. Remove the condensate trap and drain hoses from the furnace and secure the drain hoses to the drain stubs on the trap with the hose clamps (position the clamps as shown in **Figure 20**). Install the condensate trap/hose assembly to the furnace casing. Hook one side of the "clamp ears" on the drain stub through the hole in the casing and push the condensate trap into position. Secure with the two screws. Reconnect the drain hoses to the stubs on the vent fitting and the plastic transition and secure with the clamps.

Relocate the plastic caps and clamps on the condensate drain trap from the vertical drain stub to the horizontal drain stubs. Secure the clamps tightly to prevent condensate leakage.

Mount the condensate drain trap in a vertical position to the right side of the furnace using the two screws and gasket that are provided. Note: The condensate trap will be located under the furnace in a vertical position when the furnace is placed horizontally on the right side. If needed, remove the hole plugs from the furnace side panel and relocate to the open set of holes in the opposite side panel.

NOTE: All gaskets and seals must be in place for sealed combustion applications.

Ensure that the vent fitting is securely attached to the combustion blower using the clamps.

NOTE: The vent fitting **MUST** be installed with the airflow marking arrow pointed toward the vent pipe.

Plug the left drain stub on the vent fitting with the yellow plastic cap.

Remove the pressure switch hose from the upper stub on the plastic transition box.

Relocate the plastic caps on the stubs of the plastic transition from the lower stubs to the upper stubs and secure tightly with the clamps.

Route the pressure switch hose to the lower stub on the plastic transition box. Cut off excess hose and discard. Connect the pressure switch hose to the lower stub on the plastic transition box. Ensure that the hose is routed above the stub on the transition box so that condensate does not collect in the hose. **NOTE:** Failure to correctly install the pressure switch hose to the transition can adversely affect the safety control operation.

Connect the $\frac{3}{4}$ " OD rubber hose with the 90° bend to the large drain stub on the condensate trap and secure with a $\frac{3}{4}$ " clamp.

Route the hose to the drain stub on the bottom of the plastic transition box. Cut off excess hose and discard. Connect the hose to the drain stub on the transition and secure with a $\frac{3}{4}$ " clamp.

Connect the $\frac{5}{8}$ " OD rubber hose with the 90° bend to the right stub on the vent fitting and secure with a $\frac{5}{8}$ " clamp.

Route the hose to the smaller drain stub on the condensate trap. Cut off excess hose and discard. Connect the hose to the drain stub on the trap and secure with a $\frac{5}{8}$ " clamp.

NOTE: Route hoses to the condensate trap with no kinking or binding for proper condensate drainage.

Figure 21

Downflow Installations (Single Pipe & Direct Vent N9MP1 & N9MP2-A2 Models)

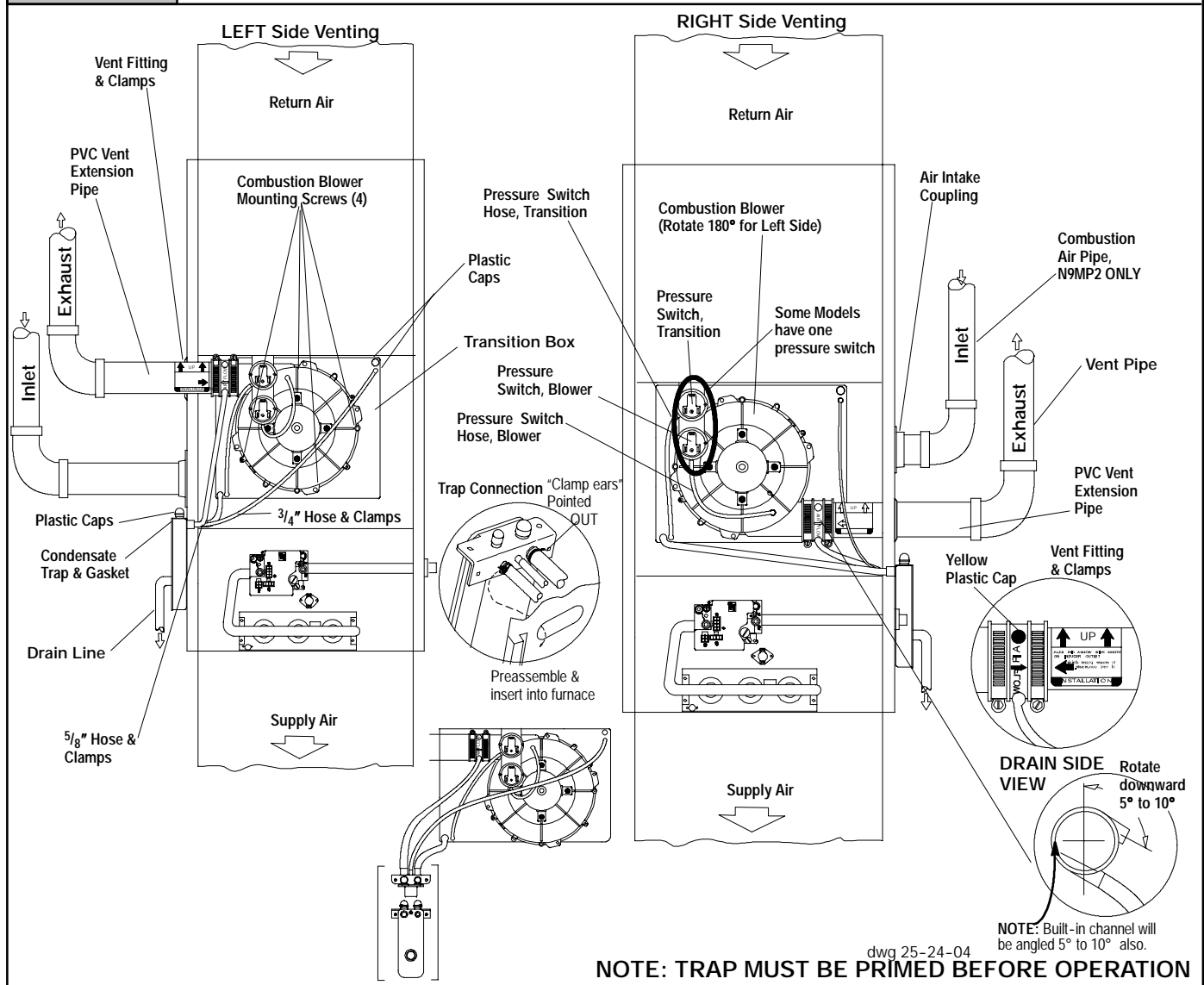

Downflow Installations - (Single Pipe & Direct Vent N9MP1 & N9MP2 Models) (See Figure 21)

NOTE: DO NOT make hose connections until the hose routing and lengths have been determined. Remove the condensate trap and drain hoses from the furnace and secure the drain hoses to the drain stubs on the trap with the hose clamps (position the clamps as shown in **Figure 21**). Install the condensate trap/hose assembly to the furnace casing. Hook one side of the "clamp ears" on the drain stub through the hole in the casing and push the condensate trap into position. Secure with the two screws. Reconnect the drain hoses to the stubs on the vent fitting and the plastic transition and secure with the clamps.

Mount the condensate drain trap in a vertical position to either the right or left side of the furnace using the two screws and gasket that are provided. If needed, remove the hole plugs from the furnace side panel and relocated to the open set of holes in the opposite side panel.

NOTE: All gaskets and seals must be in place for sealed combustion applications.

Ensure that the vent fitting is securely attached to the combustion blower using the rubber coupling and clamps.

Connect the PVC vent extension pipe to the vent fitting. **This pipe has a built-in channel to assist vent condensate disposal.** Align the arrow on the PVC pipe with the airflow marking arrow on the vent fitting. See label on the PVC pipe for proper installation. This pipe may only be shortened if an elbow is used to connect the PVC vent extension tube to field-installed vent pipe. Securely attach the PVC vent extension pipe to the vent fitting with the clamp.

This configuration allows left side venting from the furnace. If right side venting is required, the combustion blower must be relocated on the plastic transition box. Loosen the four(4) screws that secure the blower to the transition approximately 1/2". Rotate the blower 180° and secure with the four(4) screws. Note that some combustion blowers have plastic spacers on the mounting legs of the blower located at the 6 and 12 o'clock positions (blower snout to the left or right) that are required for proper fit up of the blower to the transition. Use caution to not over tighten the screws to prevent stripping out of the plastic mounting holes.

NOTE: The vent fitting **MUST** be installed with the airflow marking arrow pointed toward the vent pipe, with the drain stub at a 5° to 10° downward slope.

Plug the upper drain stub on the vent fitting with the yellow plastic cap.

Connect the PVC vent extension pipe to the vent fitting. **This pipe has a built-in channel to assist vent condensate disposal.** Align the arrow on the PVC pipe with the airflow marking arrow on the vent fitting. See label on the PVC pipe for proper installation. This pipe may only be shortened if an elbow is used to connect the PVC vent extension tube to field-installed vent pipe. Securely attach the PVC vent extension pipe to the vent fitting with the clamp.

Remove the pressure switch hose from the upper stub on the plastic transition box.

Relocate the plastic caps on the stubs of the plastic transition box from the lower stubs to the upper stubs and secure tightly with the clamps.

Route the pressure switch hose to the lower stub on the plastic transition box. Cut off excess hose and discard. Connect the pressure switch hose to the lower stub on the plastic transition box. **NOTE:** Failure to correctly install the pressure switch hose to the transition box can adversely affect the safety control operation.

Connect the $\frac{3}{4}$ " OD rubber hose with the 90° bend to the drain stub on the bottom of the plastic transition box and secure with a $\frac{3}{4}$ " clamp.

Route the hose to the large drain stub on the condensate trap. Cut off excess hose and discard. Connect the hose to the drain stub on the transition and secure with a $\frac{3}{4}$ " clamp.

Connect the $\frac{5}{8}$ " OD rubber hose with the 90° bend to the left drain stub on the vent fitting and secure with a $\frac{5}{8}$ " clamp.

Route the hose to the smaller stub on the condensate trap. Cut off excess hose and discard. Connect the hose to the drain stub on the trap and secure with a $\frac{5}{8}$ " clamp.

For left side or right side mounted condensate trap, the pressure tap on the condensate trap **MUST** be connected to the unused pressure tap located on the top of the plastic transition box. Remove the plastic caps from the pressure tap on the condensate trap and the plastic transition and connect the $\frac{5}{16}$ " OD rubber hose. (See **Figure 21**)

NOTE: Route hoses to the condensate trap with no kinking or binding for proper condensate drainage.

Connecting Vent and Combustion Air Piping

⚠ WARNING

Poison carbon monoxide gas hazard.
Cement or mechanically seal all joints, fittings, etc. to prevent leakage of flue gases.
Failure to properly seal vent piping can result in death, personal injury and/or property damage.

Refer to the **Figure 12** through **Figure 21** that corresponds to the installation position of the furnace for the application.

Preassemble the vent and combustion air piping from the furnace to the vent termination. Do not cement the pipe joints until the pipe preassembly process is complete.

Combustion Air Pipe Connection (Dual Certified or Direct Vent)

Install the air intake coupling and gasket to the furnace with the four(4) screws.

Note: The air intake coupling and gasket can be installed to the top panel to the alternate air intake locations on either the left or right side panels of the furnace.

For downflow installation, the air intake coupling and gasket must be installed to the alternate air intake location on either the left or right side panels. Remove the 3" hole plug from the side panel and relocate to the air intake hole in the top panel. Use four screws to seal the four(4) mounting holes in the top panel next to the hole plug. Drill four(4) $\frac{7}{64}$ " diameter holes in the casing using the air intake coupling as the template.

The air intake coupling is sized for 2" PVC pipe.

Install the combustion air pipe to the air intake coupling using RTV sealant to provide for future serviceability.

Vent Pipe Connection

Install the vent pipe grommet to the furnace panel. Locate the grommet in the furnace panel at a location directly away from the vent fitting on the combustion blower. The grommet snaps into the 3" hole plug from the furnace panel. **NOTE:** Depending on the installation position, the vent pipe grommet will be installed to the top panel or to the alternate location on the side panels. If needed, remove the 3" hole plug from the furnace panel and relocate to the open hole in the furnace panel. (See **Figure 16** or **Figure 21**)

Install the vent pipe to the rubber coupling, the vent fitting or the PVC vent extension pipe. Securely attach using the clamp or PVC cement as required.

Note: The vent fitting **MUST** be installed with the air flow marking arrow pointed toward the vent pipe. (See **Figure 22**) Some installations require the vent fitting to be installed with a 5° to 10° downward slope. (See **Figures 8 - 17**)

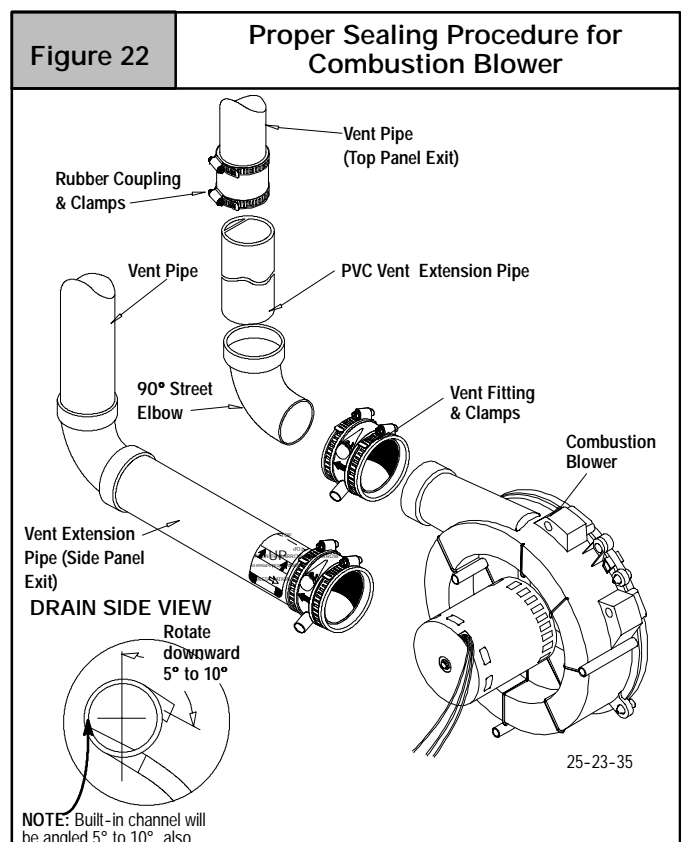

Joining Pipe and Fittings

⚠ WARNING

Fire hazard.

Provide adequate ventilation and do NOT assemble near heat source or open flame. Do NOT smoke while using solvent cements and avoid contact with skin or eyes.

Observe all cautions and warnings printed on material containers to prevent possible death, personal injury and/or property damage.

This furnace is approved for venting with Schedule 40 PVC, CPVC, ABS, Cellular Core pipe fittings and SDR-26 PVC.

NOTE: All PVC, CPVC, ABS, and Cellular Core pipe fittings, solvent cement, primers and procedures **MUST** conform to American National Standard Institute and American Society for Testing and Materials (ANSI/ASTM) standards.

- *Pipe and Fittings* - ASTM D1785, D2241, D2466, D2661, D2665, F-891, F-628
- *PVC Primer and Solvent Cement* - ASTM D2564
- *Procedure for Cementing Joints* - Ref ASTM D2855

NOTE: In order to create a seal that allows future removal of pipe, **RTV sealant MUST be used on the inlet pipe** where it joins to the furnace. PVC, CPVC, ABS, and Cellular Core pipe and cement may be used on all other joints.

CAUTION

Do NOT use solvent cement that has become curdled, lumpy or thickened and do NOT thin. Observe precautions printed on containers. For applications below 32° F., use only low temperature type solvent cement.

1. Cut pipe end square, remove ragged edges and burrs. Chamfer end of pipe, then clean fitting, socket and pipe joint of all dirt, grease, or moisture.

NOTE: Stir the solvent cement frequently while using. Use a natural bristle brush or the dauber supplied with the cement. The proper brush size is one inch.

2. After checking pipe and socket for proper fit, wipe socket and pipe with cleaner-primer. Apply a liberal coat of primer to inside surface of socket and outside of pipe. Do **NOT** allow primer to dry before applying cement.
3. Apply a thin coat of cement evenly in the socket. Quickly apply a heavy coat of cement to the pipe end and insert pipe into fittings with a slight twisting movement until it bottoms out.

NOTE: Cement **MUST** be fluid while inserting pipe. If **NOT**, recoat pipe.

4. Hold the pipe in the fitting for 30 seconds to prevent the tapered socket from pushing the pipe out of the fitting.
5. Wipe all excess cement from the joint with a rag. Allow 15 minutes before handling. Cure time varies according to fit, temperature and humidity.