



Communicating Wall Control Installation Manual TSTAT0101SC



U.S. Patent No. 7,243,004
U.S. Patent No. 7,775,452

<u>Safety Considerations</u>	7
<u>Introduction</u>	8
<u>Quick Start</u>	9
<u>Set Day and Time</u>	9
<u>Set Schedule for All Days</u>	11
<u>Installation</u>	14
<u>Overview</u>	14
<u>Check Equipment</u>	15
<u>Location</u>	15
<u>Wall Control</u>	15
<u>Remote Room Sensors</u>	16
<u>Wiring Considerations</u>	17
<u>Shielded Wire</u>	20
<u>Non-communicating equipment</u>	20
<u>Mounting</u>	21
<u>Humidifier Connection</u>	22
<u>Bypass Humidifiers</u>	23
<u>Fan Powered Humidifiers</u>	23
<u>Commissioning</u>	23
<u>Communicating System Overview</u>	23

<u>Selecting Humidifier</u>	26
<u>Selecting Indoor Unit</u>	26
<u>Selecting Outdoor Unit</u>	28
<u>Equipment Configuration</u>	29
<u>Brand Selection</u>	30
<u>Install/Service Menus – Non-Communicating Mode</u>	30
<u>Equipment Menu</u>	32
<u>Filter Reminder</u>	33
<u>Auto Mode Enable</u>	34
<u>Room Temperature Sensing</u>	35
<u>Reversing Valve</u>	36
<u>English/Metric Display</u>	37
<u>Fan on with W</u>	38
<u>Cooling Lockout</u>	39
<u>Auxiliary Heat Lockout</u>	40
<u>Heat Pump Lockout</u>	41
<u>Minimum Cooling Setpoint</u>	42
<u>Maximum Heating Setpoint</u>	43
<u>Outdoor Air Temperature Offset</u>	44
<u>Room Air Temperature Offset</u>	45

<u>Smart Recovery</u>	46
<u>Setpoint Deadband</u>	47
<u>Cycles Per Hour</u>	48
<u>Auto Changeover Timer</u>	49
<u>Time Between Fuel Types</u>	50
<u>Humidity Offset</u>	51
<u>Programming On/Off</u>	52
<u>Reset to Factory Defaults</u>	53
<u>Dealer Info</u>	54
<u>Service Reminder</u>	55
<u>Install/Service Menus – Communicating Mode</u>	55
<u>Setup Menu</u>	55
<u>Main Setup Menu</u>	56
<u>Auto Mode</u>	56
<u>Setpoint Deadband</u>	57
<u>Offsets</u>	57
<u>Cycles Per Hour</u>	57
<u>Programming</u>	58
<u>Smart Recovery</u>	58
<u>English/Metric Display</u>	58

<u>Airflow</u>	58
<u>Heating Airflow</u>	59
<u>Furnace / Fancoil Heating Airflow</u>	59
<u>Heat Pump Heating Airflow</u>	60
<u>Cooling Airflow</u>	60
<u>Dehum Airflow</u>	61
<u>Low Heat Rise</u>	61
<u>Furnace Airflow (Capacity) Limiting</u>	62
<u>Dehum Drain</u>	63
<u>Off Delay</u>	63
<u>Heat Pump/AC</u>	64
<u>Cooling Lockout</u>	64
<u>Defrost Interval</u>	65
<u>Quiet Shift</u>	66
<u>Defrost With Furnace</u>	67
<u>Filter Reminder</u>	68
<u>HRV (Heat Recovery Ventilation)</u>	69
<u>System Maintenance</u>	70
<u>Remind Owner of Routine Maintenance</u>	70
<u>Service Menus</u>	71

<u>Status</u>	71
<u>Heat Stage (Furnace)</u>	71
<u>Electric Heat (Fan Coil)</u>	71
<u>Airflow CFM</u>	72
<u>Inducer RPM (90% furnaces only)</u>	72
<u>Blower RPM</u>	72
<u>Lockout Timer</u>	72
<u>Heat Pump/AC Status</u>	72
<u>Stage: (Heat/Cool)</u>	72
<u>Defrost</u>	72
<u>Outdoor Coil Temp</u>	73
<u>Last 10 System Events</u>	73
<u>Run/Fault History</u>	75
<u>Cycle Counters</u>	75
<u>Run Timers</u>	75
<u>Appendix – Wiring Diagrams</u>	75

Safety Considerations

Improper installation, adjustment, alteration, service, maintenance, or use can cause explosion, fire, electrical shock, or other conditions which may cause death, personal injury or property damage. Consult a qualified installer, service agency or your distributor or branch for information or assistance. The qualified installer or agency must use factory--authorized kits or accessories when modifying this product. Refer to the individual instructions packaged with the kits or accessories when installing.

Follow all safety codes. Wear safety glasses, protective clothing, and work gloves. Have a fire extinguisher available. Read these instructions thoroughly and follow all warnings and cautions included in literature and attached to the unit. Consult local building codes and the current edition of the National Electrical Code (NEC) NFPA 70.

In Canada, refer to the current editions of the Canadian Electrical Code CSA C22.1.

Recognize safety information.  When you see this symbol on the unit and in instructions or manuals, be alert to the potential for personal injury. Understand these signal words: DANGER, WARNING, and CAUTION. These words are used with the safety-alert symbol. DANGER identifies the

most serious hazards which **will** result in severe personal injury or death. WARNING signifies hazards which **could** result in personal injury or death. CAUTION is used to identify unsafe practices which **may** result in minor personal injury or product and property damage. NOTE is used to highlight suggestions which **will** result in enhanced installation, reliability, or operation.

Introduction

The communicating system consists of several intelligent communicating components which includes the Observer Control, variable speed furnace or fan coil, 2-stage AC or HP, which continually communicate with each other via a four-wire communication bus. Commands, operating conditions, and other data are passed continually between components over the communication bus. The result is an enhanced level of comfort, versatility, and simplicity. All communicating furnaces or fan coils are variable-speed and multi-stage for maximum flexibility, efficiency, and comfort. They support controlled humidification, dehumidification, and air quality control. Either a communicating, or a standard 24VAC controlled outdoor unit may be used. When using conventional outdoor units, the communicating furnace or fan coil provides the 24 volt signals needed to control them. All system components are controlled through the wall

mounted Observer Control, which replaces the conventional thermostat and provides the homeowner with a single wall control for all features of the system.

Quick Start

For first time installers, Quick Start will allow a quick start up of the Observer Control before learning all the details of system operation. However, for the best possible comfort and operation refer to the Owner's Manual.

Set Day and Time



To set the current time and date, press **SETUP**; then press **TIME/DATE**.



Under date, you can select the month, day, or year buttons; then use the ▲ and ▼ to select the appropriate date. . Under time, you can select the hour, minute, and am/pm; then use the ▲ and ▼ to select the appropriate time. You also have the option of selecting between a **12 HR** or **24 HR** clock format. Finally, you can choose whether you observe day light savings time by pressing the **ON** or **OFF** button. Press **DONE** to save and exit the information that you have entered.

Set Schedule for All Days

The Observer Control gives you flexibility in how to create a comfort schedule. You can choose one schedule for all days; create a schedule for your work week and the weekend; or you can make every day different.

You can create on schedule for all seven days in the week.

1. Press **SETUP**, then **SCHEDULE**





2. Press ▲ under “All Days”, then press **EDIT**.

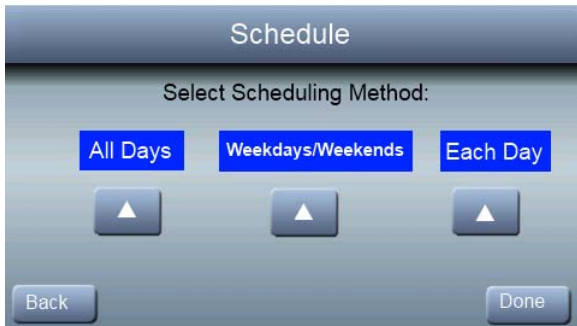

Schedule for All Days

Wake	6:00 am - 8:00 am	70	76
Day	8:00 am - 3:00 pm	66	72
Eve	3:00 pm - 11:00 pm	70	74
Sleep	11:00 pm - 6:00 am	68	76

Back

Edit

3. Press **PERIOD**; then use the ▲ or ▼ to select the period to change.

Edit Schedule for: All Days

Wake 6:00 am 70 76

Period

Start

Heat To

Cool To



Back

Save

4. Press **START**; then use the ▲ or ▼ to change the time the corresponding period starts.
5. Press **HEAT TO**; then use the ▲ or ▼ to change the desired heating temperature for that period.
6. Press **COOL TO**; then use the ▲ or ▼ to change the desired heating temperature for that period.
7. Press **DONE** after you have completed your edits.
8. Press **SAVE** to save your new schedule and exit (or press **CANCEL** to exit without saving.)

Installation

Overview

This instruction covers installation of the Observer Control **only**. Physical installation instructions for the indoor and outdoor equipment and accessories are provided with each unit. Setup, commissioning, operation, and troubleshooting of the communicating system are covered only in this installation instruction. It is the guide to connecting the system components and commissioning the system once all physical components are installed. Special screen prompts and start-up capabilities are provided in the communicating system to

simplify and automate the initial commissioning of the system.

Install Observer Control according to this instruction.

Install indoor unit, outdoor unit, and accessories according to their instructions.

Wire complete system according to this instruction.

Setup, commission, and operate system according to this instruction to assure a smooth and trouble free start-up.

Check Equipment

Inspect equipment. File claim with shipping company prior to installation if shipment is damaged or incomplete.

Location

All wiring must comply with national, local, and state codes.

Wall Control

The Observer Control is the command center for the communicating system. It should be located where it is easily accessible and visible to the adult homeowner or end user. For accurate temperature measurement, the following guidelines should be followed:

The Observer Control and Room Sensors **SHOULD** be mounted:

Approximately 5-ft (1.5 m) from the floor.

Close to or in a frequently used room, preferably on an inside partitioning wall.

On a section of wall without pipes or ductwork.

The Observer Control and Room Sensors **SHOULD NOT** be mounted:

Close to a window, on an outside wall, or next to a door leading to the outside.

Exposed to direct light or heat from a lamp, sun, fireplace, or other temperature-radiating objects which could cause a false reading.

Close to or in direct airflow from supply registers.

In areas with poor air circulation, such as behind a door or in an alcove.

Remote Room Sensors

A Remote Room Sensor can be used with the Observer Control to take the place of the control's internal temperature sensor. This allows the Observer Control to be mounted in areas with less than optimal airflow (such as near an exterior door, window or in a closet). The remote sensor can be wired to the terminal block connectors labeled S1 and S2 at the control's back-plate. The Observer Control will automatically detect the Remote Room Sensor and ignore its internal temperature sensor. Typically, one remote sensor is used

but, multiple sensors may be used and averaged in some applications. Averaging requires a special series-parallel wiring method with a specific number of sensors. See Fig. 1. It is also important to note the humidity sensor cannot be remotely located, so do not locate the Observer Control in an area where humidity sensing may not be accurate.

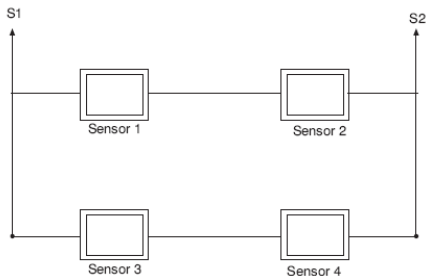

Fig. 1 – Remote Room Sensor – Parallel Wiring
Wiring Considerations

Ordinary thermostat wire is recommended. Use 22 AWG or larger for normal wiring applications. Continuous wire lengths over 100 ft. should use 20 AWG or larger.

NOTE: The communicating bus wiring only requires a four-wire connection; however, it is good practice to run ther-

mostat cable having more than four wires in the event of a damaged or broken wire during installation.

Each communicating device in the system has a four-pin connector. It is recommended that the following color code be used when wiring each device:

DX+ — Green = Data A

DX- — Yellow = Data B

C — White = 24VAC (Com)

R — Red = 24VAC (Hot)

NOTE: TERMINAL MARKINGS FOR EACH COMMUNICATING SYSTEM COMPONENT MAY NOT BE IN THE SAME ORDER. IT IS NOT MANDATORY THAT THE ABOVE COLOR CODE BE USED, BUT EACH CONNECTOR IN THE SYSTEM **MUST** BE WIRED CONSISTENTLY.

A separate four-pin connector comes inside packaging and should be used when connecting to furnace (or fan coil). Ensure connector is inserted properly into circuit board.

1. Turn off all power to equipment.
2. If an existing thermostat or control is being replaced:
 - a. Remove existing thermostat from wall.
 - b. Disconnect wires from existing thermostat.
 - c. Discard or recycle old thermostat.

NOTE: Mercury is a hazardous waste, if existing control contains any mercury, it **MUST** be disposed of properly. The Observer Control does not contain mercury.

3. Select Observer Control mounting plastic
4. Route wires through hole in mounting plastic. Level rear plastic against wall (for aesthetic value only - Observer Control need not be level to operate properly) and mark wall through two mounting holes.
5. Drill two 3/16-in (4.8 mm) mounting holes in wall where marked.
6. Secure mounting plastic to wall using two screws and anchors provided.
7. Adjust length and routing of each wire to reach each wire entry on the connector back-plate. Strip 1/4--in (6.4 mm) of insulation from each wire.
8. Match and connect thermostat wires to proper terminals on wall control back-plate. See wiring diagram XX in Appendix A.
9. Push any excess wire into the wall. Seal hole in wall to prevent any air leaks. Leaks can affect operation.
10. Attach Observer Control to the mounting plastic by lining up the plastic guides on the back of the control with the opening on the mounting plastic and push on.

11. Perform installation of all other system equipment (i.e. humidifier, UV lights, etc.).

12. Turn on power to equipment.

NOTE: In a dual fuel installation with a non-communicating heat pump, an OAT sensor must be installed, or the heat pump will not run.

Shielded Wire

If the thermostat wiring will be located near or in parallel with high voltage wiring, cable TV or Ethernet wiring, then shielded thermostat wire can be used to reduce or eliminate potential interference. The shield wire should be connected to the C terminal, or ground, at the indoor unit. The shield wire should NOT be connected to any terminal at the wall control. Connecting the shield to ground at both ends can cause current loops in the shield, reducing shield effectiveness.

Non-communicating equipment

The Observer Control, when paired with the NAXA00101DB daughter board, will operate non-communicating equipment. When the system utilizes the NAXA00101DB daughter board, the Observer Control operates as a standard universal thermostat. See Appendix Wiring Diagrams

Mounting

First become familiar with all plastic assembly pieces shown in Figure 2. The wall control will snap together with the back-plate. A back-plate is supplied Figure 2. Attach back-plate using only a small hole in the wall allowing a four wire connection to pass through. Mount the assembly to the back-plate.

NOTE: Once Observer Control is secured to wall with the back-plate assembly (snapped together), care must be taken not to bend or break the interlocking tabs when removing.

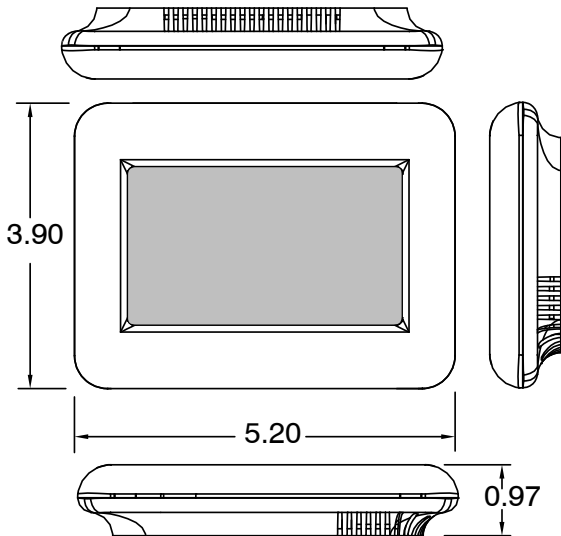

**Fig. 2 – Wall Control Assembly Pieces
Humidifier Connection**

A 24VAC bypass or fan powered humidifier may be installed.

NOTE: Do Not Use a traditional humidistat to control humidifier operation. If a humidifier is installed, let the Observer Control operate humidifier.

Bypass Humidifiers

A bypass humidifier should be wired directly to the furnace or fan coil HUM and 24VAC COM terminals. The Observer Control will automatically energize the HUM output during a call for humidification.

Fan Powered Humidifiers

Most fan powered humidifiers produce internal 24VAC in order to energize upon a switch or contact closure. For this application, a 24VAC N.O. Isolation Relay (DPST) **MUST** be used to prevent mixing the internal humidifier power with the indoor equipment transformer. Applying 24VAC isolation relay coil to furnace or fan coil HUM and COM terminals will allow the Observer Control to automatically energize the HUM output during a call for humidification. The N.O. relay contacts will be used to energize the humidifier. See fan powered humidifier installation instructions for more details.

Commissioning

Overview

This section addresses initial power up (or commissioning) of an Observer Control. The wall control will communicate and identify all communicating components in the system.

The wall control will light up and indicate that it is now “FINDING INDOOR EQUIPMENT”, followed by “FINDING OUTDOOR EQUIPMENT”



Finding Indoor Equipment...

Software Version 0.01



Finding Outdoor Equipment...

Software Version 0.01

Once the indoor and outdoor equipment has been found, the Installer will be asked to select if a humidifier is installed.

NOTE: If the communicating indoor equipment (furnace or fan coil) cannot be found, the wall control will display the option to enter THERMOSTAT DEMO MODE or to retry the search for equipment. The system will only operate in THERMOSTAT DEMO MODE if no communicating equipment is found.

If a communicating indoor unit is found, but a communicating outdoor unit or relay board is not found, the installer will be prompted to select the outdoor type; either AC, Heat Pump, or NONE.

Selecting Accessories

Once the indoor and outdoor equipment have been found or entered, the following screen will appear allowing the Installer to select “HUMIDIFIER INSTALLED”. Press **YES** or **NO** to make the appropriate selection.

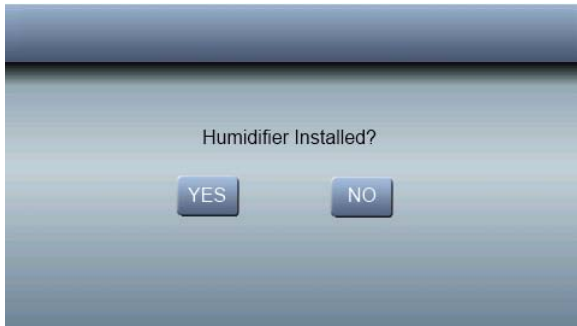

Selecting Outdoor Unit

If there is no communicating indoor unit, the screens below will appear. The installer should select the indoor unit type (furnace or fan coil), then select the indoor unit stages (single or two-stage).

SELECT INDOOR UNIT:

FURNACE

FAN COIL / ELECTRIC FURNACE

INDOOR UNIT STAGES

SINGLE STAGE

TWO STAGE

Selecting Outdoor Unit

If there is no communicating outdoor unit, the screens below will appear. The installer should select the outdoor unit type (heat pump, air conditioner or none), then select the outdoor unit stages (single or two-stage).

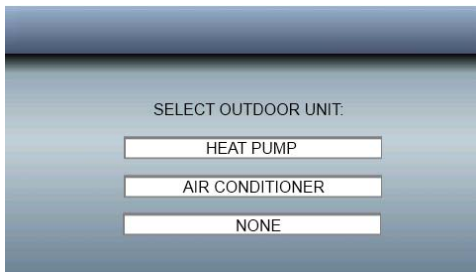

SELECT OUTDOOR UNIT:

HEAT PUMP

AIR CONDITIONER

NONE

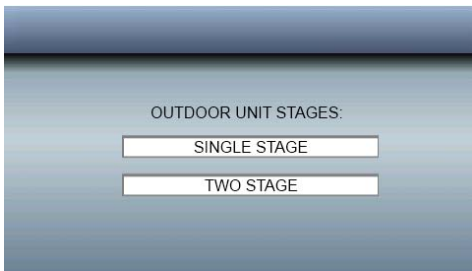

OUTDOOR UNIT STAGES:

SINGLE STAGE

TWO STAGE

Equipment Summary

The “EQUIPMENT CONFIGURATION” screen will appear after the humidifier screen. This screen will give a summary of all equipment automatically found or manually selected. If a wrong selection was made, press **RELEARN** to go back. When all of the equipment is correct, press **SAVE**.



The screenshot shows a screen titled "Equipment Configuration" with a light blue background. It displays the following information:

Indoor Equipment:	Outdoor Equipment:
Furnace:	Heat Pump:
Model: *9MAC	Model: *SH5
Serial: 5211A12345	Serial: 5211E12345

Accessories: Humidifier

At the bottom of the screen, there are two buttons: "RELEARN" on the left and "SAVE" on the right.

Brand Selection

After the commissioning of the Observer Control, the installer will be prompted to select the appropriate brand. After the brand selection, or **NO LOGO** is made, the installer will have the opportunity to confirm the choice. If the brand selection is correct, press **DONE**, otherwise press **BACK** to select a different brand.

Install/Service Menus

Install/Service Menus – Non-Communicating Mode

The “**INSTALLER CONFIGURATION**” menus contain vital information. This information enables the Installer or Service person to view a summary of what has been installed, etc. This information is not covered in the Owner’s Manual.

To enter **INSTALLER CONFIGURATION** menus, press and hold the **FAN BUTTON** for at least ten seconds. The following menu will appear: (If an item is grayed out, that item is not applicable to the equipment configuration selected – for example, reversing valve will be grayed out if a standard AC system is selected).

Installer Configuration Menu 1 of 4

Equipment

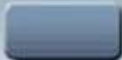

Reversing
Valve

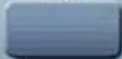

Filter
Reminder



F/C

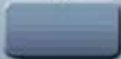

Auto Mode
Available

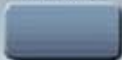

Fan on
With W

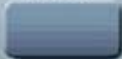

Room Temp
Sensor

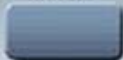

MORE

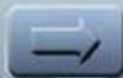

DONE

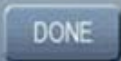

NOTE: The **INSTALL / SERVICE** menu will automatically exit after 60 minutes of no activity.

Equipment Summary Menu

This screen shows indoor unit type and model number, outdoor unit type (and model number if a communicating outdoor unit), and any accessories that are installed are recognized.



Setup Menu

Select the number of hours of fan operation after which the replace filter reminder shall appear.

Off – The Replace Filter Reminder function is disabled

800-7200 hours – in 800 hour increments after which the reminder shall appear

Default = 3200 hours



Auto Mode Enable

When Auto Mode is enabled (factory default) a change from heat to cool (or vice versa) will not occur until the current cycle is satisfied and an opposite mode demand has existed for 30 minutes. If the set-point is changed, the 30 minute timer is deleted.

On – Auto mode is available

Off – Auto Mode is not available

Default = On.



Room Temperature Sensing

The room air temperature can come from one of three sources: the local sensor in the wall control, the remote room air sensor, or the average of the local and remote sensors.

Local – use the local sensor in the wall control

Remote – use the remote room sensor and ignore the thermostats on board sensor

Average – average the temperature readings from the local and remote sensors

Default = Local

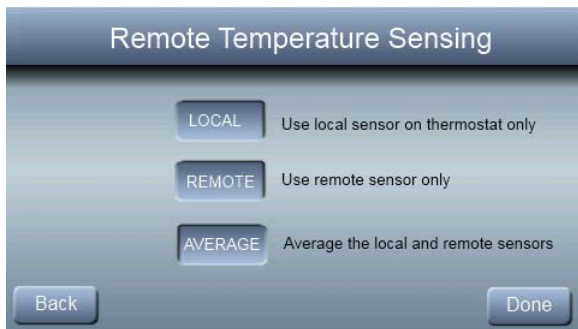

Reversing Valve

For heat pump applications, the reversing valve will be active with heating or cooling operation.

Heat

Cool (default)

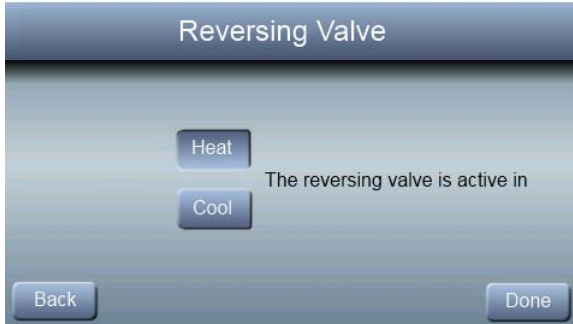

English/Metric Display

Displaying temperature in English or Metric Values

F – all temperatures and setpoints shown in degrees Fahrenheit

C – all temperatures and setpoints shown in degrees Celsius

Default = degrees F

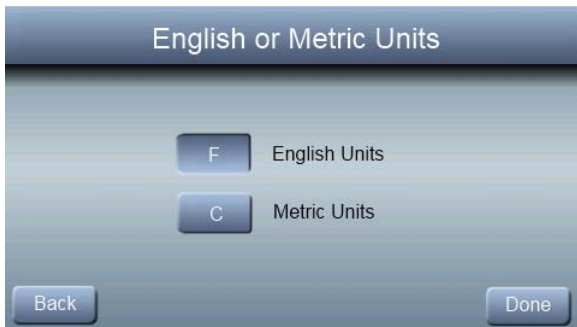

Fan on with W

An option to turn the fan on with a call for furnace heating

ON

OFF (default)

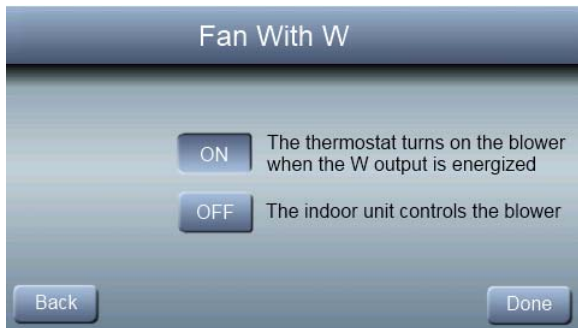

Cooling Lockout

When enabled, cooling will not be provided when the outside temperature is below 55° F.

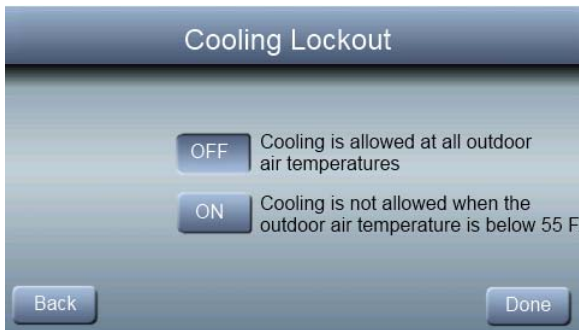

Off – Cooling is allowed at all outdoor air temperatures

On – Cooling not allowed when outdoor air temperature is below 55° F.

Default = Off

Auxiliary Heat Lockout

With heat pump systems, the auxiliary heat will not be used when the outside temperature is above this setting.

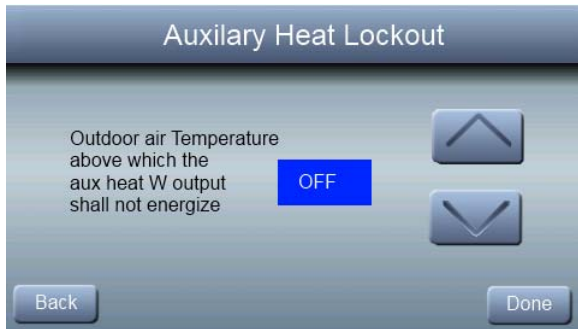

Off – The auxiliary heat can turn on whenever sufficient demand exists regardless of outside air temperature.

5°-55° F – Outside air temperature above which the auxiliary heat will be inactive

Default = Off

Heat Pump Lockout

With heat pump systems, the outside air temperature below which the heat pump will be locked out and only auxiliary heat will be used.

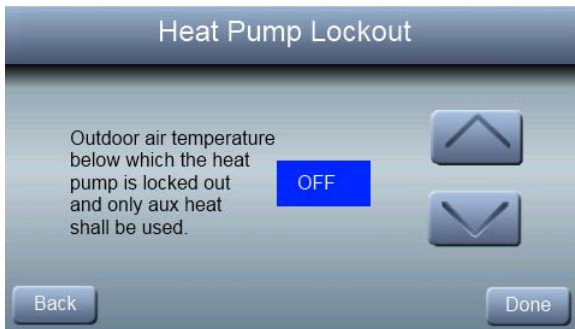

Off – The heating cycle will always start with the heat pump regardless of the outside air temperature

5°-55° F – Outside air temperature below which the heat pump will be locked out and only auxiliary heat will be used.

Default = Off

Minimum Cooling Setpoint

The minimum cooling setpoint the user is allowed to set on the thermostat

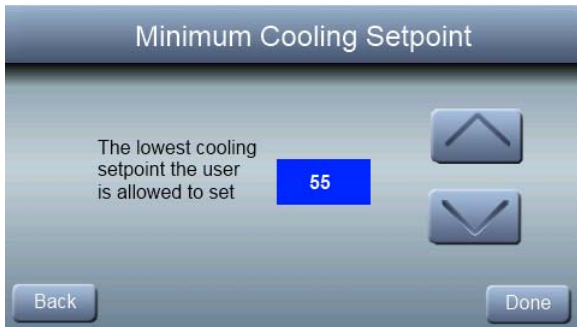

52°F to 90°F (12°C to 32°C)

Default = 52°F (12°C)

Maximum Heating Setpoint

The maximum heating setpoint the user is allowed to set on the thermostat



50°F to 88°F (10°C to 30°C)

Default = 88°F (30°C)

Outdoor Air Temperature Offset

This option allows calibration (or deliberate mis-calibration) of the outdoor temperature. This offset is added to the actual temperature values.

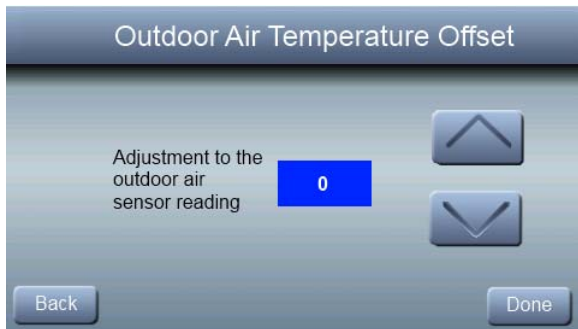

-5°F to +5°F (-3°C to +3°C) – Number of degrees added to the actual temperature value

Default = 0

Room Air Temperature Offset

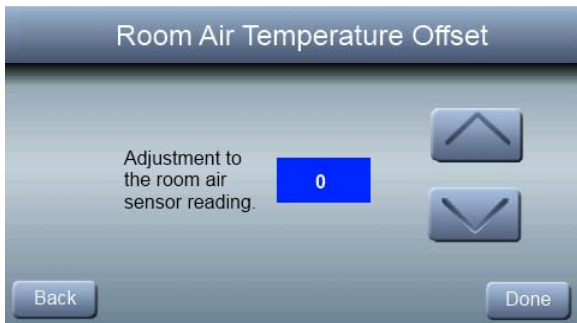

-5°F to +5°F (-3°C to +3°C) – Number of degrees added to the actual temperature value

Default = 0

Smart Recovery

This feature applies to programmable operation only. The control will start recovery X minutes prior to schedule change in both heating and cooling mode as energy efficiently as possible.



Off – at the programmed time, the setpoints shall be changed to the next programmed settings

30, 60 or 90 – the number of minutes prior to schedule change that the system will start to recover.

Default = 90 minutes

Setpoint Deadband

The minimum difference enforced between heating and cooling desired temperatures. This can allow one setting to “push” the other to maintain this difference.

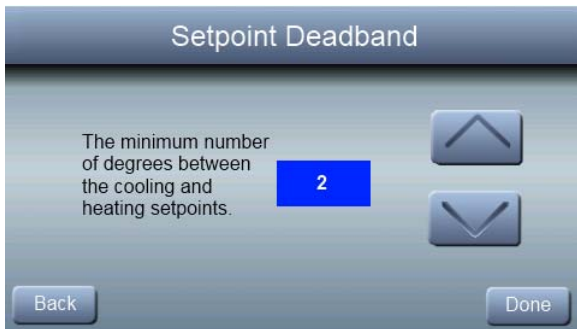

2° to 6° - minimum number of degrees between the heating and cooling setpoints

Default = 2°

Cycles Per Hour

The maximum number of heating or cooling cycles per hour.

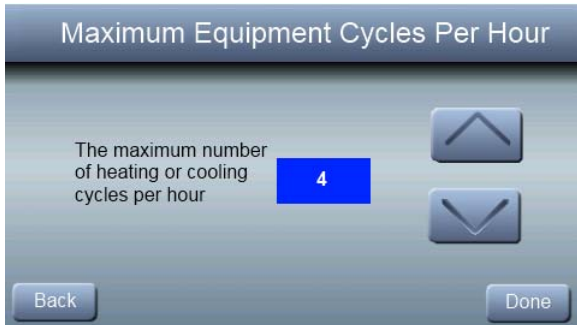

2 – The Y, Y2, W and W2 outputs shall be energized at most twice per hour

4 – The Y, Y2, W and W2 outputs shall be energized at most four times per hour

6 – The Y, Y2, W and W2 outputs shall be energized at most six times per hour

Default = 4

Auto Changeover Timer

This feature designates the minimum number of minutes between heating and cooling operation when in auto mode.

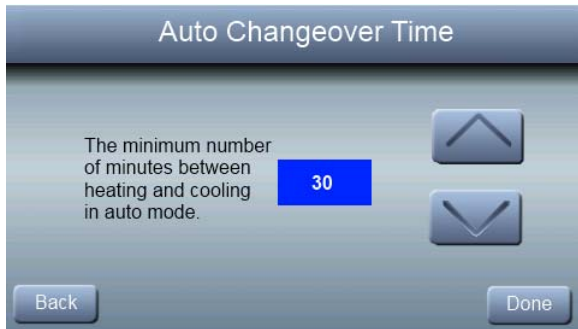

5 to 30 minutes (5 minute increments)

Default = 30 minutes

Time Between Fuel Types

The minimum amount of time the Y1 and Y2 output must be energized in heating before turning on the W1 output.

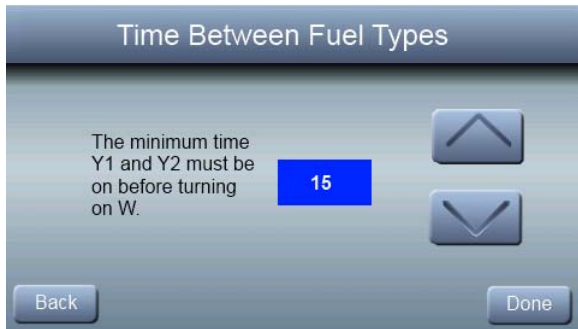

10 to 25 minutes (5 minute increments)

Default = 15 minutes

Humidity Offset

This option allows calibration (or deliberate mis-calibration) of the humidity sensor. This offset is added to the actual humidity value. The Test Humidifier option allows the Humidifier to be toggled on and off for testing.



-10 to +10%
Default = 0%

Programming On/Off

This feature allows the thermostat to turn off the programming mode and operate as a non-programmable thermostat.

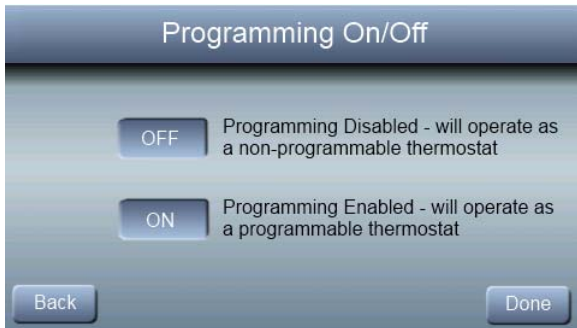

Off – operates as a non-programmable thermostat

On – allows program schedule to be set by user

Default = On

Reset to Factory Defaults

This feature allows the installer to return the thermostat to its factory default settings. The installer will need to hold the ▼ button down for 10 seconds to reset settings.

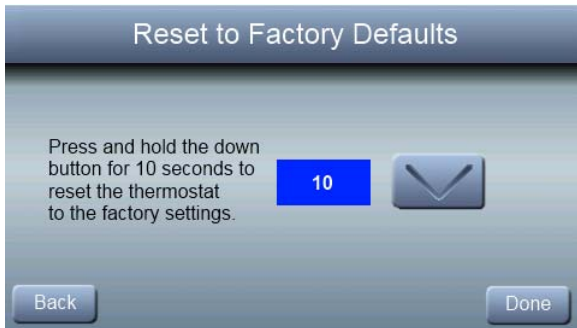

Dealer Info

These screens allow the dealer to input contact information. The dealer contact information will appear when the user selects dealer info after service or maintenance reminders are displayed on the screen.

A screenshot of a mobile application screen titled "Dealer Info". The screen has a dark blue header with the title in white. Below the header, there are six white text input fields, each preceded by a label: "Dealer Name:", "Dealer Phone:", "Dealer Address 1:", "Dealer Address 2:", "Dealer Email:", and "Dealer Website:". In the bottom right corner, there is a blue button with the word "Done" in white text.

Dealer Info

Dealer Name:

Dealer Phone:

Dealer Address 1:

Dealer Address 2:

Dealer Email:

Dealer Website:

Done

Service Reminder

This setup is used to adjust the timer interval in which the normal System Maintenance notification is turned on for the homeowner.

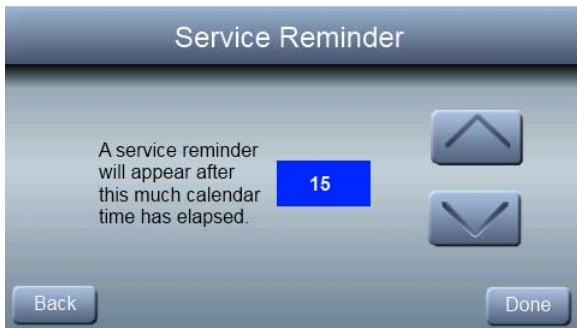

0 to 24 months (1 month increments)

Default = 12 months

Install/Service Menus – Communicating Mode

Setup Menu

This menu has several layers, allowing modification of equipment settings. No settings will need to be made at equipment

(i.e. DIP switches on a furnace). All configuration settings made effective from this menu will override equipment configuration made by dip switches. Upon a initial startup discovery of the Observer Control, DIP switch settings will be copied into the setup menu. Any changes can then be made from the Observer Control. The screen below shows a portion of the information that can be found in the **INSTALLER SETUP** menu.

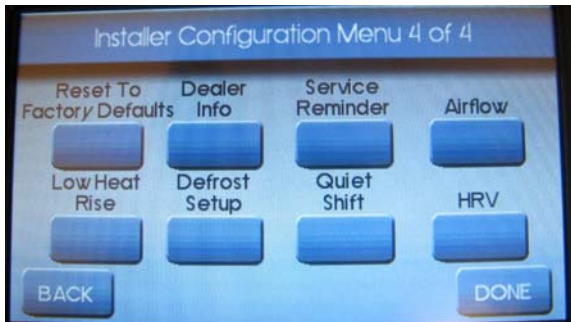

Main Setup Menu

Auto Mode

When Auto Mode is enabled (factory default) a change from heat to cool (or vice versa) will not occur until the current cycle is satisfied and an opposite mode demand has existed

for 30 minutes. If the set-point is changed, the 30 minute timer is deleted.

Enable/Disable Auto Changeover mode (default = Enable).

Auto Changeover Time may be adjusted 5 to 120 minutes, (default = 30 minutes).

Setpoint Deadband

The minimum difference enforced between heating and cooling desired temperatures. This can allow one setting to “push” the other to maintain this difference.

0 to 6°F (0 to 3°C), (default = 2°F)

Offsets

This option allows calibration (or deliberate mis-calibration) of the temperature and humidity sensors. These offsets are added to the actual temperature/humidity values (default = 0).

Temperature Offset: -5°F to +5°F (-3°C to +3°C)

Outside Temp Offset: -5°F to +5°F (-3°C to +3°C)

Humidity Offset: -10 to +10%

Cycles Per Hour

Maximum cycles per hour = 4 (default) or 6.

Programming

ON (default) - allows program schedule to be set by user.

OFF - system becomes non--programmable

Smart Recovery

This feature applies to programmable operation only. The control will start recovery 90 minutes prior to schedule change in both heating and cooling mode. Refer to operational information for more detail.

On or Off (default = On)

English/Metric Display

°F or °C, (default = °F)

Airflow

Upon a first time start-up of the Observer Control, the furnace DIP switch settings will be copied to the furnace setup menu. Any changes can then be made from the Observer Control.

Heating Airflow

Furnace / Fancoil Heating Airflow

Selects the airflow of the indoor unit when heating. **EFFICIENCY** is the airflow used to meet specified ratings, **COMFORT** is a decreased airflow used to increase the output air temperature and provide increased comfort.

COMFORT (default)

EFFICIENCY

MIN CFM (modulating furnace only) – runs the modulating furnace at the minimum CFM

MAX CFM modulating furnace only) – runs the modulating furnace at the maximum CFM

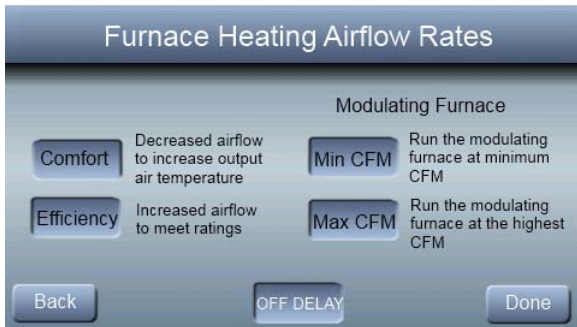

Heat Pump Heating Airflow

COMFORT (default) -- Heat Pump airflow is varied depending on outdoor temperature to maximize comfort.

EFF 325 -- Fixed airflow used to achieve specified ratings. This is nominally 325 CFM/ton, but will vary if a 2--stage outdoor unit is used.

EFF 350 -- Fixed airflow used to achieve specified ratings. This is nominally 350 CFM/ton, but will vary if a 2--stage outdoor unit is used.

MAXIMUM -- 400 CFM/ton.

Cooling Airflow

COMFORT (default) -- cooling airflow is varied depending on humidity and temperature demands settings. This selection enables the full dehumidify and comfort capabilities of the system. When COMFORT is not selected, the unit will not run reduced airflows for dehumidification.

EFF 325 -- fixed airflow used to achieve specified ratings -- no dehumidification airflow reduction. This is nominally 325 CFM/ton, but will vary if a 2--stage outdoor unit is used.

EFF 350 -- fixed airflow used to achieve specified ratings -- no dehumidification airflow reduction. This is nominally 350 CFM/ton, but will vary if a 2--stage outdoor unit is used.

MAXIMUM -- 400 CFM/ton. No dehumidification airflow reduction.

Dehum Airflow

NORMAL (default) -- When equipment is running to dehumidify, the airflow is allowed to adjust to a minimum to satisfy the dehumidification call.

HIGH -- Minimum airflow during the dehumidify mode is increased to reduce duct and register sweating.

Low Heat Rise

Set to **ON** if the system contains a bypass humidifier. The **ON** setting will increase the furnace low heat airflow.

On

Off (default)

Low Heat Rise Setup

Enable Low Heat Rise For Furnace Operation?

On

Used if a bypass humidifier is installed to increase furnace low heat airflow.

Off

Use standard low heat airflow. Used with standard (non-bypass) humidifiers

Back

Done

Furnace Airflow (Capacity) Limiting

The following settings allow the installer to restrict the furnace within certain minimum and maximum airflows. These airflows are converted to capacities. The Min and Max limits are determined by the equipment size.

Min CFM (only appears with modulating furnaces)

Minimum CFM to run a modulating furnace. This will increase the minimum operating capacity of the furnace. Default value is the furnace air flow for the lowest heat capacity.

Maximum CFM (only appears with modulating furnaces)

Maximum CFM to run a modulating furnace. This will reduce the operating capacity of the furnace. Default value is the furnace air flow for the highest heat capacity.

Dehum Drain

Turns off the continuous fan at the end of cooling cycle for five minutes in order to drain the indoor coil of water. The fan will only be turned off if a dehumidify demand existed at the start of or during the cooling cycle. Default is enabled.

Off Delay

Amount of time the blower will continue to run after heating has shut off.

90 seconds

120 seconds (default)

150 seconds

180 seconds

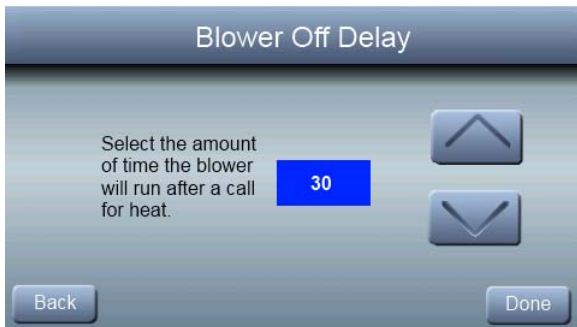

Heat Pump/AC

Cooling Lockout

Selecting **ON** will enable the low ambient cooling operation in the outdoor unit. This setting is only available with communicating outdoor units and with Cooling Lockout set to **OFF**. Low ambient kits are not needed with communicating outdoor units. For detailed sequence of operation, see outdoor unit installation instructions.

OFF (default)

ON

Defrost Interval

Time interval at which defrost cycles can occur on a heat pump.

30 minutes

60 minutes

90 minutes

120 minutes (default)

Auto-Defrost interval optimized by outdoor control (default for communicating HP)

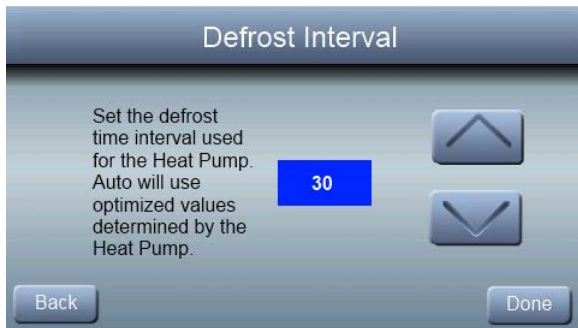

Quiet Shift

Turns on Quiet Shift function in 1-stage or 2-stage communicating heat pumps.

OFF (default)

ON

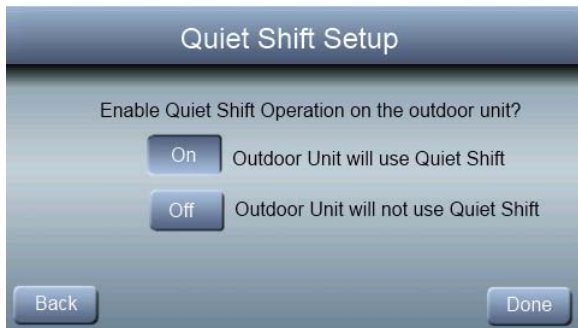

Defrost With Furnace

Choose whether furnace operates during defrost cycle.

YES (default)

NO

Furnace Defrost Setup

Furnace Operation During Defrost?

Yes | Furnace will run during defrost

No | Furnace will not run during defrost

Back Done

Filter Reminder

CLEAN INTERVAL: Enables a timer for the filter notification. Interval at which the Clean Filter notification will turn on.

Off to 7200 hours.



HRV (Heat Recovery Ventilation)

Energizes the fan output at the specified speed for HRV applications

DISABLED (Default)

LOW

MEDIUM

HIGH



System Maintenance

Remind Owner of Routine Maintenance

This setup is used to adjust the timer interval in which the normal System Maintenance notification is turned on for the homeowner.

OFF

6 to 24 months, (default = 12 months)

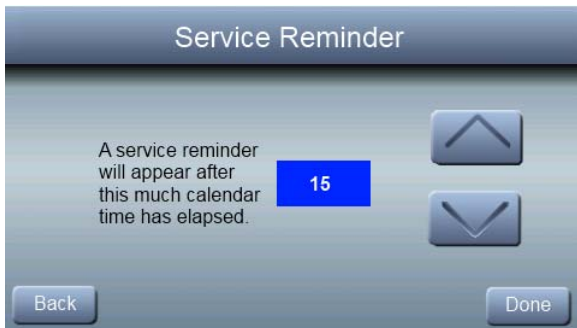

Service Menus

Status



The Status screens will show all of the current operating parameters of each installed piece of equipment.

Heat Stage (Furnace)

Displays stage of heat that the furnace is currently delivering.

OFF, LOW, HIGH

% capacity (modulating furnace only)

Electric Heat (Fan Coil)

Displays stages of electric heat that the fan coil is currently delivering.

OFF, LOW, MED, HIGH

Airflow CFM

Cubic Feet per Minute of air the blower is currently delivering.

(model dependent)

Inducer RPM (90% furnaces only)

Inducer motor RPM value.

Blower RPM

Actual RPM feedback from indoor blower motor.

Lockout Timer

If a lockout timer is active, this will show the current time value. See equipment manual for details on lockout timers.

Seconds

Heat Pump/AC Status

Stage: (Heat/Cool)

Displays stage of heating or cooling that the Heat Pump/AC is delivering.

OFF, HIGH, LOW

Defrost

NO, YES

Outdoor Coil Temp

Temperature of the outdoor unit coil (only available on 2-stage communicating outdoor units).

°F or °C (default = °F)

Last 10 System Events

This screen will show last 10 events that occurred throughout the system. Each entry has the time and date incident recorded. Service technician should enter current date in the DATE menu section BEFORE checking and logging the last 10 system events. Each entry has a two--letter acronym preceding the event name to identify which piece of equipment generated the event. This event history can be cleared under Thermostat Setup, Reset Factory Defaults.

HP = Heat Pump

AC = Air Conditioner

FN = Furnace

FC = Fan Coil

Last 10 System Faults

FN 09/10/11 10:00AM Low Pressure Switch - 12 Events - **ACTIVE**
HP 09/11/11 01:23PM Communications - 1 Event - INACTIVE

Back

Clear

Done

Run/Fault History

The indoor unit and outdoor unit (if communicating) have the following histories:



Cycle Counters

Number of heat/cool/power cycles the unit has performed.

Run Timers

Lifetime hours of operation in heating, cooling, and how long the unit has been powered.

Appendix – Wiring Diagrams

Communicating Indoor Unit with Communicating AC/HP (Two Wire System)

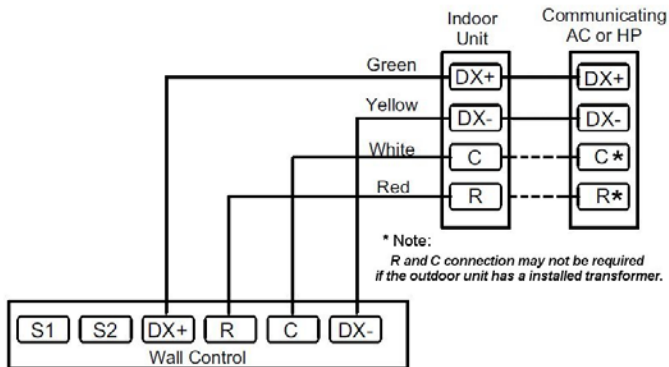

Communicating Variable Speed Gas Furnace with Single Stage Non-Communicating AC

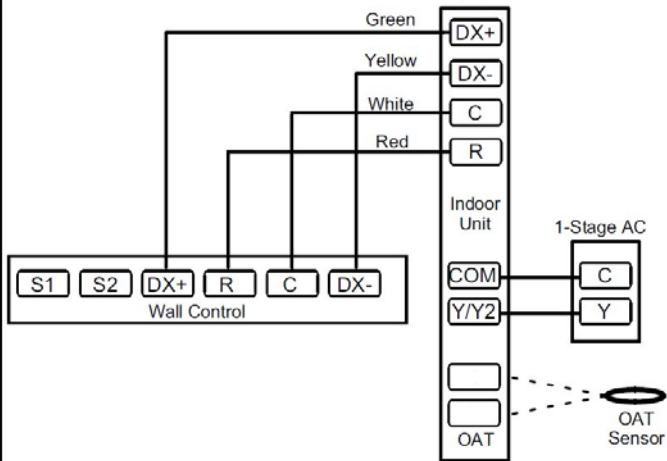

Communicating Fan Coil Single Stage Non-Communicating HP

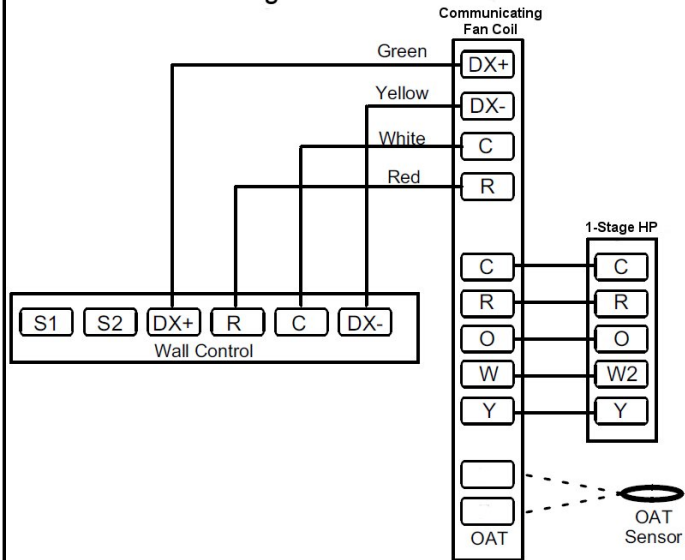

Communicating Indoor Unit with Two Stage Non-Communicating AC/HP

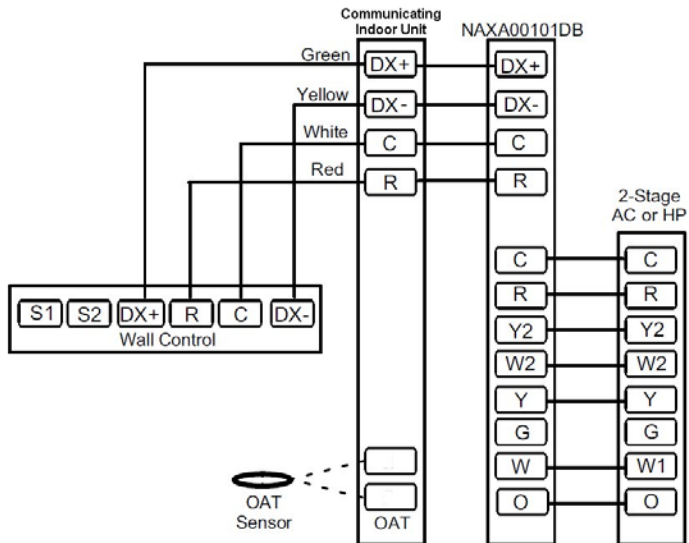

Non-Communicating Indoor Unit with Non-Communicating Outdoor

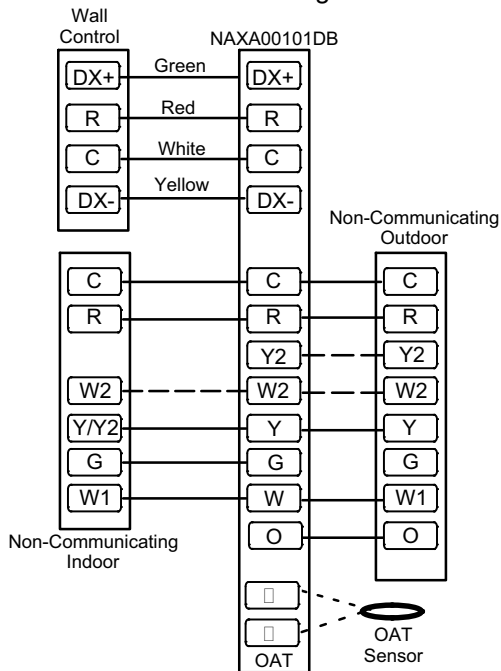

Copyright 2013 International Comfort Products
PO Box 128 • Lewisburg, TN 37091 USA