

---

**Residential and Light Commercial  
Ductless Systems Catalog**

July 2020





## Table of Contents

|   |           |
|---|-----------|
| <b>About Heil®</b>                            | <b>3</b>  |
| <b>Ductless Benefits</b>                      | <b>5</b>  |
| <b>Single and Multi-Zone Solutions</b>        | <b>9</b>  |
| <b>Single Zone Residential</b>                | <b>13</b> |
| QuietComfort® Deluxe Series                   | <b>15</b> |
| QuietComfort® Series                          | <b>21</b> |
| Performance Series                            | <b>35</b> |
| <b>Multi-Zone</b>                             | <b>43</b> |
| <b>Single Zone Light Commercial</b>           | <b>49</b> |
| <b>Accessories and Additional Information</b> | <b>67</b> |
| <b>Tiers, Warranties &amp; Controls</b>       | <b>74</b> |
| <b>Glossary</b>                               | <b>76</b> |





## About Heil®

### HEIL® — QUALITY PERFORMANCE FOR YEAR-ROUND COMFORT

Heil® is the trusted HVAC brand for delivering comfort every hour of every season. Our heating and cooling systems are backed by superior engineering and manufacturing to ensure the best quality, energy efficiency and dependability.

As an Heil® dealer, you rely on high-quality, affordable products for cost-conscious, smart homeowners; products that help you stay competitive and reinforce your reputation. So we've teamed up with Midea to expand our innovation and offer the best ductless systems on the market.

Our ductless lineup gives dealers like you an expansive range of products that fit any heating and cooling challenge and need — with any budget.

---

#### Our ductless portfolio features and benefits include:

- A full product line with three tiers for both single and multi-zone uses, designed for the North American consumer
- High efficiency and performance (up to 40.0 SEER)
- Wi-Fi® connectivity available for all systems
- New consumer features, such as humidity control and occupancy sensors
- Wide operating range to handle any temperature and climate, with especially high-heating performance on our high and mid-tier systems
- Newly redesigned entry tier units with improved heating and cooling operating ranges, along with innovative service and maintenance features
- A new light commercial portfolio with multiple indoor unit styles
- A basepan heater that comes with each heat pump system

---

Those who know Heil® trust our ability to solve challenges quickly and keep customers happy. We understand what you need to be successful, and we're here to help you offer the greatest value and support.

## Why Choose a Ductless System?

**Ductless systems, or “mini-splits,” are a convenient, economical and energy-efficient air conditioning and heating solution that can be used in one room or easily expanded to multiple rooms.**

### **DUCTLESS MEANS WHAT IT SOUNDS LIKE, NO DUCTS NEEDED.**

Installing or expanding an HVAC system might not always be the best solution for your changing heating and cooling needs. With a ductless system you only need to run small refrigerant linesets from an outdoor unit directly to the indoor unit in rooms you want to heat or cool. Installation is faster, requires less labor and is less disruptive to a home or business.

Ductless systems can also help you avoid costly energy loss by shortening the distance the air has to travel while at the same time giving you more control over the comfort level of your spaces. By setting up and controlling individual zones, homeowners can save money by only heating or cooling rooms that are occupied. With highly efficient Inverter systems and the condenser stationed outside, ductless systems are also a quiet solution.

Heil® Ductless Systems can be an energy-saving solution for a variety of applications that help customers regain control of their space, including, but not limited to:

- New construction and renovations
- Homes and businesses
- Single or multi-family
- Primary living areas
- Rooms that are often too hot or too cold
- Basements, attics, garages, additions
- Server rooms

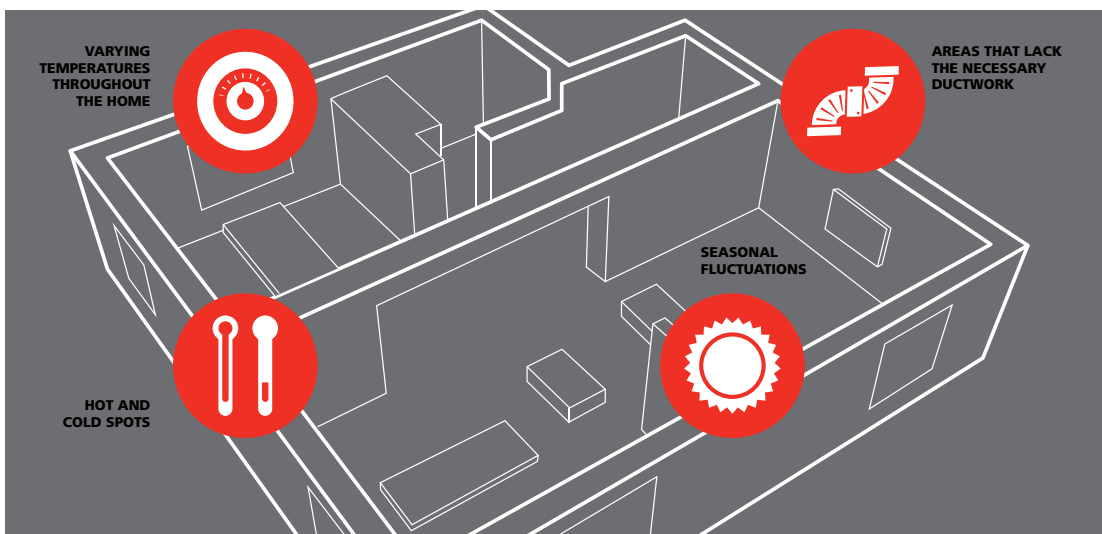

## Heil® Ductless Advantages

### PERFORMANCE



**Easy Installation and Use** — A simple and intuitive remote allows users to easily control their unit(s). For installation, an innovative bracket holds the wall unit in place, allowing for easy connection to the refrigeration unit. And for multi-zone installs, there's no need for a branch box, which saves installation effort and costs.



**Broad Temperature Range** — Our models provide low temperature heating to a frigid -22° F, with up to 89% of rated capacity at -13° F, and cooling even when temperatures reach as high as 122° F.



### EFFICIENCY

**Low Energy Use** — With SEER ratings of 40.0 on our highest tier offering, we have one of the highest efficiency ratings in the world.



**ENERGY STAR® Certification** — Full Inverter technology in the high tier and mid-tier series not only allows for quieter operation, but also delivers industry-leading efficiency. In fact, 70% of our QuietComfort® Series models are ENERGY STAR® certified.



**Washable Filters** — Our filters are specifically manufactured for cleaner air quality and reduced allergens. The filtration systems also allow for easy cleaning and replacing.



### INNOVATION

**Inverter Technology** — Unlike traditional compressors that turn on and off multiple times, Heil® Inverter compressors feature variable power that automatically adjusts the running speed to maintain the desired temperature. That way, a Heil® unit runs quietly and features significant energy savings.



**Wi-Fi® Enablement** — Easy connectivity with an intuitive app allows users to control and monitor our systems across all tiers, from a handheld device, anytime, anywhere.



**Flexible Options** — We offer several types of indoor unit styles to fit all customer needs and situations. And our versatile outdoor options allow users the ability to leverage just one outdoor unit across up to five indoor units at a time.



**MEETING THE FULL SPECTRUM OF  
HEATING & COOLING NEEDS**

At Heil®, it's our mission to help customers gain control of their space, whether it's a small residential room or a large commercial application.

---

That's why we offer a broad lineup of flexible and versatile ductless solutions that meet a wide range of needs—**from compact and efficient residential units to bigger and stronger light commercial products.**

---

Most other manufacturers can't give you access to such a breadth of solutions.





**Heil® Ductless Systems provide an efficient, flexible and customizable heating and cooling solution for a single area of a home or business, or a multi-zone solution to individually manage several different zones using one integrated system of indoor and outdoor units.**

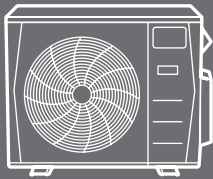

**Single zone systems** provide comfort for areas with as little as 350 and as much as 3,000 square feet — either small offices or bedrooms, or big living and cooking areas.

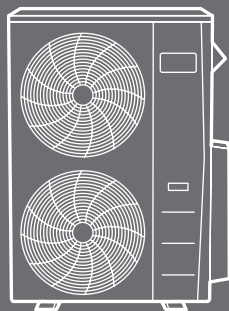



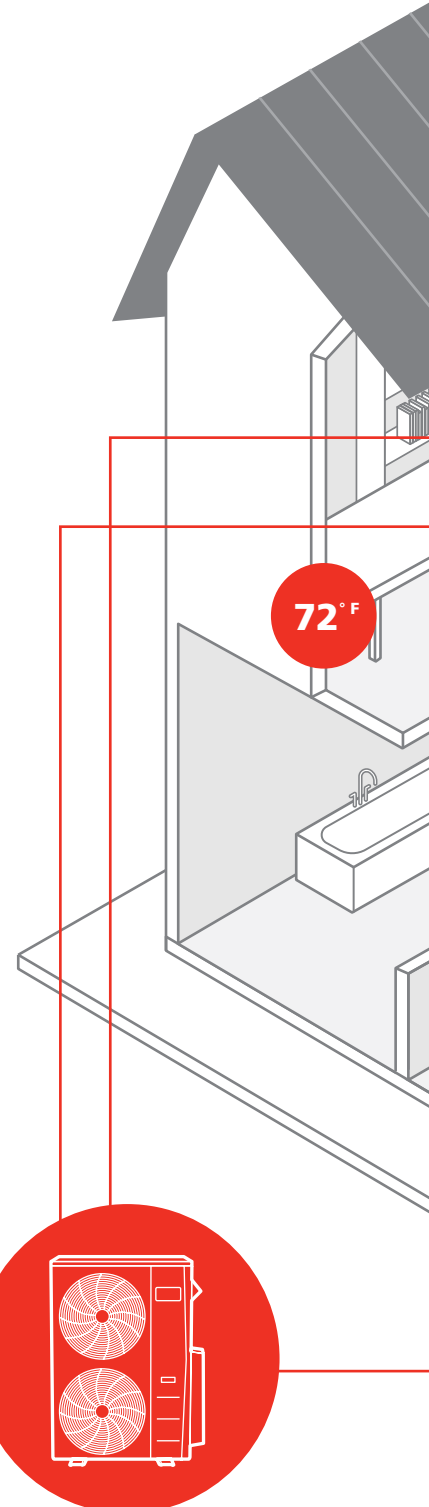

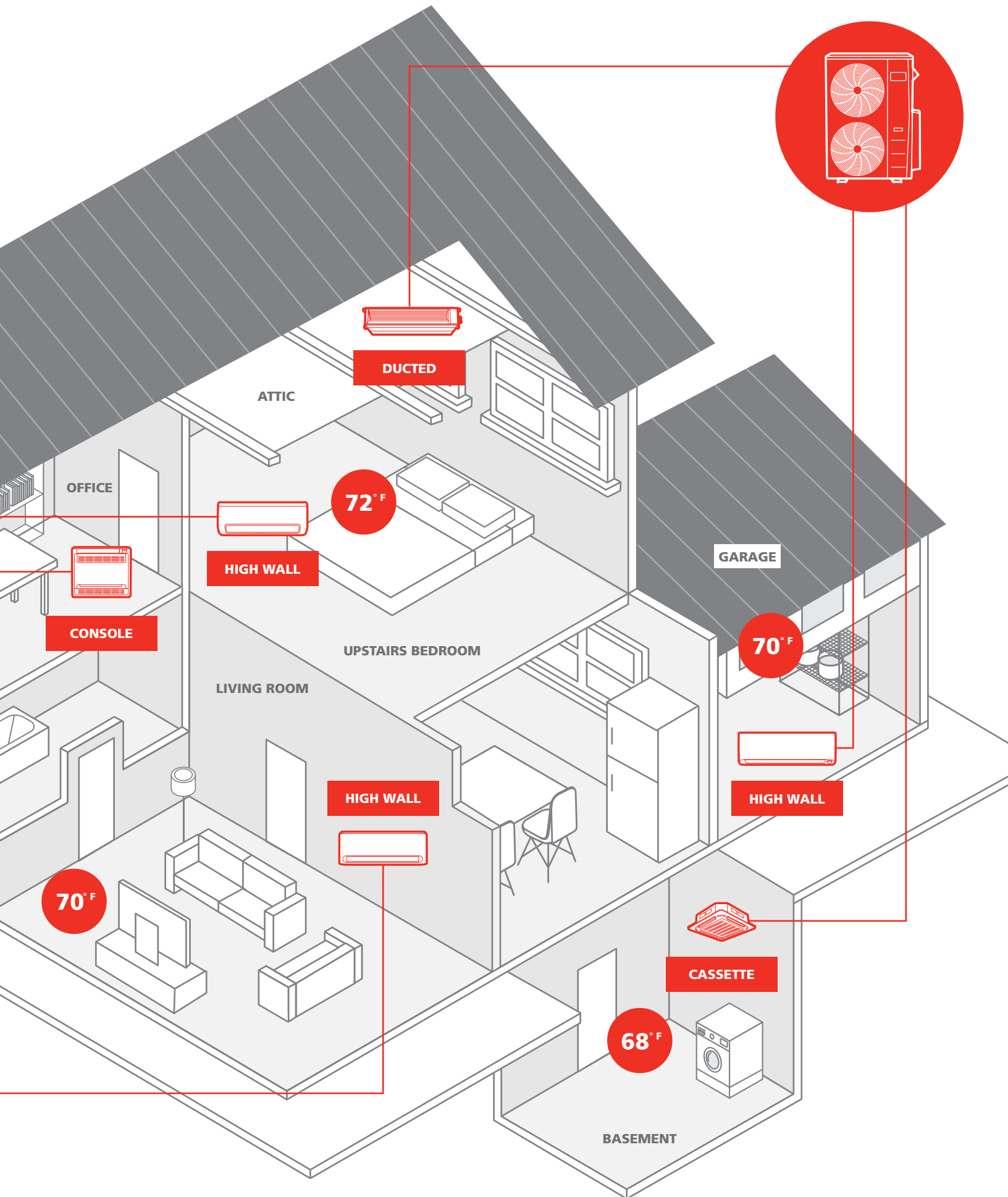







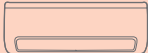
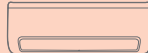



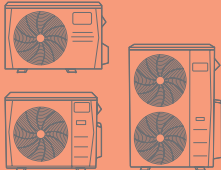



**Multi-zone systems** can connect as many as five indoor units with a single outdoor unit — with comfort all around the house or application, using individual controls for zoning and energy savings.



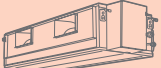

## The Right Product for the Right Application

|  | SINGLE ZONE RESIDENTIAL  |  | MULTI-ZONE  |  |
|--|--|--|---|--|
|  | Indoor Units   | Outdoor Units  | Indoor Units  | Outdoor Units  |
| <b>QUIETCOMFORT®<br/>DELUXE SERIES</b> | <br><b>DLFPHA High Wall</b><br>Sizes: 09 / 12                     | <br><b>DLCPPRA Outdoor Unit</b><br>Up to 40.0 SEER<br>Sizes: 09 / 12 / 18 / 24            | <br><b>DLFPHA High Wall</b><br>Sizes: 09 / 12                     |  |
|  | <br><b>DLFPHA High Wall</b><br>Sizes: 18 / 24                     |  |   |  |
| <b>QUIETCOMFORT®<br/>SERIES</b>        | <br><b>DLFSHA High Wall</b><br>Sizes: 09 / 12 / 18 / 24 / 30 / 36 |  | <br><b>DLFSHA High Wall</b><br>Sizes: 09 / 12 / 18 / 24 / 30 / 36 |  |
|  | <br><b>DLFSCA Cassette</b><br>Sizes: 09 / 12 / 18 / 24          | <br><b>DLCSRA Outdoor Unit</b><br>Up to 24.7 SEER<br>Sizes: 09 / 12 / 18 / 24 / 30 / 36 | <br><b>DLFSCA Cassette</b><br>Sizes: 09 / 12 / 18 / 24          | <br><b>DLCMRA Outdoor Unit</b><br>Up to 21.4 SEER<br>Sizes: 18 / 27 / 36 / 48 |
|  | <br><b>DLFSDA Ducted</b><br>Sizes: 09 / 12 / 18 / 24            |  | <br><b>DLFSDA Ducted</b><br>Sizes: 09 / 12 / 18 / 24            |  |
|  | <br><b>DLFSFA Console</b><br>Sizes: 12 / 18 / 24                |  | <br><b>DLFSFA Console</b><br>Sizes: 12 / 18 / 24                |  |
| <b>PERFORMANCE SERIES</b>              | <br><b>DLFEHA High Wall</b><br>Sizes: 09 / 12 / 18 / 24         | <br><b>DLCERA Outdoor Unit</b><br>Up to 17.6 SEER<br>Sizes: 09 / 12 / 18 / 24           | <br><b>DLFEHA High Wall</b><br>Sizes: 09 / 12 / 18 / 24         |  |

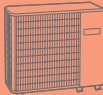
| SINGLE ZONE LIGHT COMMERCIAL   |   |
|--|---|
| Indoor Units   | Outdoor Units   |
|  <p><b>DLFLCA Cassette</b><br/>Sizes: 36 / 48</p>  <p><b>DLFLDA Ducted</b><br/>Sizes: 36 / 48 / 58</p>  <p><b>DLFLFA Console</b><br/>Sizes: 36 / 48 / 58</p> |   <p><b>DLCLRA Outdoor Unit</b><br/>Up to 18.0 SEER<br/>Sizes: 36 / 48 / 58</p>  <p><b>NH4A4 &amp; NH4H4 Outdoor Units</b><br/>Sizes: 18 / 24 / 30 / 36 / 48 / 60</p> |

| SYSTEM  | SIZES                              | SEER            | HSPF            | Page  |
|---|------------------------------------|-----------------|-----------------|-------|
| <b>SINGLE ZONE RESIDENTIAL</b>                |                                    |                 |                 |       |
| <b>DLCPRA Outdoor Unit</b>                    | Sizes: 09 / 12 / 18 / 24           | Up to 40.0 SEER | Up to 14.5 HSPF | 15-16 |
| <b>DLFPHA High Wall</b>                       | Sizes: 09 / 12                     |                 |                 | 17-18 |
| <b>DLFPHA High Wall</b>                       | Sizes: 18 / 24                     |                 |                 | 19-20 |
| <b>DLCSRA Outdoor Unit</b>                    | Sizes: 09 / 12 / 18 / 24 / 30 / 36 | Up to 24.7 SEER | Up to 11.0 HSPF | 21-24 |
| <b>DLFSHA High Wall</b>                       | Sizes: 09 / 12 / 18 / 24 / 30 / 36 |                 |                 | 25-26 |
| <b>DLFSCA Cassette</b>                        | Sizes: 09 / 12 / 18 / 24           |                 |                 | 27-28 |
| <b>DLFSDA Ducted</b>                          | Sizes: 09 / 12 / 18 / 24           |                 |                 | 29-30 |
| <b>DLFSFA Console</b>                         | Sizes: 12 / 18 / 24                |                 |                 | 31-32 |
| <b>DLCERA Outdoor Unit</b>                    | Sizes: 09 / 12 / 18 / 24           | Up to 17.6 SEER | 10.6 HSPF       | 33-36 |
| <b>DLFEHA High Wall</b>                       | Sizes: 09 / 12 / 18 / 24           |                 |                 | 37-40 |
| <b>MULTI-ZONE</b>                             |                                    |                 |                 |       |
| <b>DLCMRA Outdoor Unit</b>                    | Sizes: 18 / 24 / 30 / 36 / 48      | Up to 21.4 SEER | Up to 10.8 HSPF | 45-48 |
| <b>SINGLE ZONE LIGHT COMMERCIAL</b>           |                                    |                 |                 |       |
| <b>DLCLRA Outdoor Unit</b>                    | Sizes: 36 / 48 / 58                | Up to 18.0 SEER | Up to 11.5 HSPF | 51-54 |
| <b>DLFLCA Cassette</b>                        | Sizes: 36 / 48                     |                 |                 | 55-56 |
| <b>DLFLDA Ducted</b>                          | Sizes: 36 / 48 / 58                |                 |                 | 57-58 |
| <b>DLFLFA Console</b>                         | Sizes: 36 / 48 / 58                |                 |                 | 59-60 |
| <b>RESIDENTIAL HORIZONTAL DISCHARGE UNITS</b> |                                    |                 |                 |       |
| <b>NH4A4 &amp; NH4H4 Outdoor Units</b>        | Sizes: 18 / 24 / 30 / 36 / 48 / 60 | 16.5 SEER       | Up to 9 HSPF    | 61-66 |

# SINGLE ZONE RESIDENTIAL



**DLCPRA Outdoor Unit**  
Up to 40.0 SEER  
Sizes: 09 / 12 / 18 / 24



**DLFPHA High Wall**  
Sizes: 09 / 12



**DLFPHA High Wall**  
Sizes: 18 / 24



**DLCSRA Outdoor Unit**  
Up to 24.7 SEER  
Sizes: 09 / 12 / 18 / 24 / 30 / 36



**DLFSHA High Wall**  
Sizes: 09 / 12 / 18 / 24 / 30 / 36



**DLFSCA Cassette**  
Sizes: 09 / 12 / 18 / 24



**DLFSDA Ducted**  
Sizes: 09 / 12 / 18 / 24



**DLFSFA Console**  
Sizes: 12 / 18 / 24



**DLCERA Outdoor Unit**  
Up to 17.6 SEER  
Sizes: 09 / 12 / 18 / 24



**DLFEHA High Wall**  
Up to 17.6 SEER



# A Versatile Outdoor Unit for Precise Temperature Control

## OUTDOOR FEATURES

- 100% Heating capacity at 0° F (-17° C)
- 100% Cooling capacity at -22° F (-30° C) without additional kit
- Up to 75% of Heating capacity at -22° F (-30° C)
- Available in 208/230V
- Built-in basepan heater
- Auto-restart function
- Refrigerant leakage detection
- Quiet outdoor operation, as low as 55 dB(A)
- Anti-corrosive fin coating
- Piping length 98 ft. (30 m.)
- Cooling operating range -22° ~ 122° F (-30° ~ 50° C)
- Heating operating range -22° ~ 86° F (-25° ~ 30° C)

## COMPATIBLE WITH:

- DLFPHA High Wall (p 17)

## Heat Pump with Basepan Heater

Inverter Compressor

Up to 40.0 SEER

Up to 14.5 HSPF

Sizes: 09 / 12 / 18 / 24

All systems are ENERGY STAR® certified



## KEY FEATURES

### Extra Low Temperature Heating

Heat output up to 75% of rated capacity down to -22° F (-30° C), so when it's cold outside, it will be warm inside making this a primary heat source, and reducing the need for a backup heat source.

### Stepless Frequency Adjustment

Precise control maintains stable and constant room temperature while reducing sound level and energy consumption.

## COMPATIBILITY:

| Indoor Unit |              | Outdoor Unit |              |              |              |
|-------------|--------------|--------------|--------------|--------------|--------------|
|             |              | DLCPRAH09AAK | DLCPRAH12AAK | DLCPRAH18AAK | DLCPRAH24AAK |
| High Wall   | DLFPHAH09XAK | •            |              |              |              |
|             | DLFPHAH12XAK |              | •            |              |              |
|             | DLFPHAH18XAK |              |              | •            |              |
|             | DLFPHAH24XAK |              |              |              | •            |



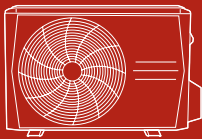

**SPECIFICATIONS:**

| DLCPRA Outdoor Unit            |           |                  |                  |                  |                  |
|--------------------------------|-----------|------------------|------------------|------------------|------------------|
| Heat Pump                      |           |                  |                  |                  |                  |
| System                         |           |                  |                  |                  |                  |
| Size                           |           | 9                | 12               | 18               | 24               |
| Outdoor Model                  |           | DLCPRAH09AAK     | DLCPRAH12AAK     | DLCPRAH18AAK     | DLCPRAH24AAK     |
| Electrical                     |           |                  |                  |                  |                  |
| Voltage-Phase-Cycle            | V-Ph-Hz   | 208/230-1-60     | 208/230-1-60     | 208/230-1-60     | 208/230-1-60     |
| MCA                            | A.        | 13               | 15               | 18               | 20               |
| MOCP - Fuse Rating             | A.        | 15               | 20               | 30               | 30               |
| Operating Range                |           |                  |                  |                  |                  |
| Cooling Outdoor DB Min - Max   | ° F (° C) | -22~122 (-30~50) | -22~122 (-30~50) | -22~122 (-30~50) | -22~122 (-30~50) |
| Heating Outdoor DB Min - Max   | ° F (° C) | -22~86 (-30~30)  | -22~86 (-30~30)  | -22~86 (-30~30)  | -22~86 (-30~30)  |
| Piping                         |           |                  |                  |                  |                  |
| Total Piping Length            | ft (m)    | 98 (30)          | 98 (30)          | 98 (30)          | 98 (30)          |
| Piping Lift*                   | ft (m)    | 49 (15)          | 49 (15)          | 65 (20)          | 65 (20)          |
| Pipe Connection Size - Liquid  | in (mm)   | 1/4 (6.35)       | 1/4 (6.35)       | 3/8" (9.52)      | 3/8" (9.52)      |
| Pipe Connection Size - Suction | in (mm)   | 3/8 (9.52)       | 1/2 (12.7)       | 5/8" (15.9)      | 5/8" (15.9)      |
| Refrigerant                    |           |                  |                  |                  |                  |
| Type                           |           | R410A            | R410A            | R410A            | R410A            |
| Charge                         | lbs (kg)  | 3.5 (1.58)       | 3.5 (1.58)       | 5.7 (2.6)        | 6.5 (2.95)       |
| Outdoor                        |           |                  |                  |                  |                  |
| Unit Width                     | in (mm)   | 33.27 (845)      | 33.27 (845)      | 37.24 (946)      | 37.24 (946)      |
| Unit Height                    | in (mm)   | 27.64 (702)      | 27.64 (702)      | 31.89 (810)      | 31.89 (810)      |
| Unit Depth                     | in (mm)   | 14.29 (363)      | 14.29 (363)      | 16.14 (410)      | 16.14 (410)      |
| Net Weight                     | lbs (kg)  | 107.59 (48.8)    | 108.47 (49.2)    | 135.4 (61.4)     | 145.1 (65.8)     |
| Airflow                        | CFM       | 1,380            | 1,380            | 2,236            | 2,236            |
| Sound Pressure                 | dB(A)     | 55.5             | 56.0             | 61.5             | 62.0             |

\*Condensing unit above or below indoor unit.

**PERFORMANCE:**

| High Wall                        |       |              |              |               |               |
|----------------------------------|-------|--------------|--------------|---------------|---------------|
| Indoor Model                     |       | DLFPHAH09XAK | DLFPHAH12XAK | DLFPHAH18XAK  | DLFPHAH24XAK  |
| <b>ENERGY STAR®</b>              |       | <b>YES</b>   | <b>YES</b>   | <b>YES</b>    | <b>YES</b>    |
| Cooling System Tons              |       | 0.8          | 1.0          | 1.5           | 1.8           |
| Cooling Rated Capacity           | Btu/h | 9,000        | 12,000       | 18,000        | 22,000        |
| Cooling Cap. Range Min - Max     | Btu/h | 5,000~17,000 | 5,800~19,000 | 6,888~30,511  | 7,445~32,644  |
| SEER                             |       | 40.0         | 30.0         | 28.2          | 23.5          |
| EER                              |       | 15           | 13.5         | 14.5          | 13.65         |
| Heating Rated Capacity (47° F)   | Btu/h | 10,000       | 12,000       | 18,000        | 24,000        |
| Heating Rated Capacity (17° F)   | Btu/h | 7,200        | 6,800        | 12,300        | 15,450        |
| Heating Maximum Capacity (17° F) | Btu/h | 15,690       | 17,070       | 22,000        | 22,000        |
| Heating Maximum Capacity (5° F)  | Btu/h | 13,000       | 13,800       | 18,000        | 24,000        |
| Heating Cap. Range Min - Max     | Btu/h | 3,100~19,000 | 3,500~21,000 | 10,835~29,414 | 12,050~32,270 |
| HSPF                             |       | 14.5         | 13.6         | 14.0          | 12.0          |
| COP (47° F)                      | W/W   | 4.00         | 4.24         | 4.12          | 3.89          |
| COP (17° F)                      | W/W   | 2.78         | 2.64         | 3.20          | 3.00          |
| COP (5° F)                       | W/W   | 2.00         | 2.00         | 2.00          | 2.00          |

Manufacturer reserves the right to discontinue, or change at any time, specification or designs without notice or incurring obligations.



# Superior Comfort from a Single Energy Efficient Unit

## INDOOR FEATURES

- Available in 208/230V
- Relative Humidity Sensor
- Occupancy Sensor
- Modes: Cool, Heat, Dry, Fan, Auto
- Turbo Mode
- Fully modulating fan speeds
- Sleep Mode
- Up-down / right-left louver control (fixed or swing)
- ECO Mode
- Carbon filter
- Follow Me (senses temperature at handheld remote)
- Heating Setback (46° F Heating Mode)
- Quiet indoor operation, as low as 29 dB(A)
- Anti-corrosive fin coating
- Up to 40.0 SEER and 14.5 HSPF when paired with DLCPRA outdoor unit

## COMPATIBLE WITH:

- DLCPRA Outdoor Unit Single Zone (p 15)
- DLMRA Outdoor Unit Multi-Zone (p 45)

Sizes: 09 / 12

All systems are ENERGY STAR® certified based on outdoor unit pairing



## KEY FEATURES

### Relative Humidity Sensor

Increase comfort by setting the desired relative humidity in 5% increments in a range of 35% ~ 85%.

### Occupancy Sensor

Detects activity in the room and adjusts the horizontal angle of airflow to blow away from people or follow people.

### Wi-Fi®

Wi-Fi® connectivity is available (see below.)

## CONTROLS

Wireless Remote Controller included with indoor unit

Optional Wired Remote Controller KSACNo401AAA (7-Day Programmable)



**Wireless Remote Controller**



**Wired Controller (7-Day Programmable) KSACNo401AAA**

## ACCESSORIES

Wi-Fi® Kit KSAIFo601AAA



24V Interface for third-party thermostat compatibility KSAICo401230



**SPECIFICATIONS:**

| <b>DLPFA High Wall</b>             |              |                                       |                   |
|------------------------------------|--------------|---------------------------------------|-------------------|
| <b>Heat Pump</b>                   |              |                                       |                   |
| <b>System</b>                      |              |                                       |                   |
| Size                               |              | 9                                     | 12                |
| Indoor Model                       |              | DLPFAH09XAK                           | DLPFAH12XAK       |
| <b>Electrical</b>                  |              |                                       |                   |
| Voltage-Phase-Cycle                | V-Ph-Hz      | 208/230-1-60                          | 208/230-1-60      |
| Power Supply                       |              | Indoor unit powered from outdoor unit |                   |
| MCA                                | A.           | 0.3                                   | 0.3               |
| <b>Operating Range</b>             |              |                                       |                   |
| Cooling Indoor DB Min - Max        | ° F (° C)    | 62~90 (17~32)                         | 62~90 (17~32)     |
| Heating Indoor DB Min - Max        | ° F (° C)    | 32~86 (0~30)                          | 32~86 (0~30)      |
| <b>Piping</b>                      |              |                                       |                   |
| Pipe Connection Size - Liquid      | in (mm)      | 1/4 (6.35)                            | 1/4 (6.35)        |
| Pipe Connection Size - Suction     | in (mm)      | 3/8 (9.52)                            | 1/2 (12.7)        |
| <b>Indoor</b>                      |              |                                       |                   |
| Unit Width                         | in (mm)      | 35.2 (895)                            | 35.2 (895)        |
| Unit Height                        | in (mm)      | 11.7 (298)                            | 11.7 (298)        |
| Unit Depth                         | in (mm)      | 9.8 (248)                             | 9.8 (248)         |
| Net Weight                         | lbs (kg)     | 37.48 (17)                            | 37.48 (17)        |
| Number of Fan Speeds               |              | 4                                     | 4                 |
| Airflow (lowest to highest)        | CFM          | 144/245/295/345                       | 168/252/306/357   |
| Sound Pressure (lowest to highest) | dB(A)        | 29/35.5/41.5/45.6                     | 29/35.5/41.5/46.8 |
| Air Throw Data                     | ft (m)       | 21.98 (6.7)                           | 22.97 (7)         |
| Moisture Removal                   | Pint/h (L/h) | 2.11 (1.0)                            | 2.53 (1.2)        |
| Field Drain Pipe Size O.D.         | in (mm)      | 1 (25.4)                              | 1 (25.4)          |

**COMPATIBILITY:**

|                           |  |              |
|---------------------------|--|--------------|
| Indoor Unit               | DLPFAH09XAK  | DLPFAH12XAK  |
| Outdoor Unit Single Zone* | DLCBRAH09AAK   | DLCBRAH12AAK |
| Outdoor Unit Multi-Zone*  | DLCPRAH18BAK<br>DLCPRAH27CAK<br>DLCPRAH36DAK<br>DLCPRAH48EAK |              |

\*Performance may vary based on the compatible outdoor units. See respective pages for performance data.



# High Efficiency & Performance for Large Spaces

## INDOOR FEATURES

- Available in 208/230V
- Modes: Cool, Heat, Dry, Fan, Auto
- Turbo Mode
- Fully modulating fan speeds
- Sleep Mode
- Up-down / right-left louver control (fixed or swing)
- Relative Humidity Sensor
- ECO Mode
- Carbon filter
- Follow Me (senses temperature at handheld remote)
- Heating Setback (46° F Heating Mode)
- Quiet indoor operation, as low as 29 dB(A)
- Anti-corrosive fin coating

## COMPATIBLE WITH:

- DLCRA Outdoor Unit Single Zone (p 15)

Sizes: 18 / 24

ENERGY STAR® certified  
based on outdoor unit pairing



## KEY FEATURES

### Large Residential Applications

A solution for large residential applications where more airflow or load is necessary, such as basements, garages, large living rooms, or even used as a centralized system.

### Light Commercial Applications

With excellent performance and capacity these units can be installed in larger load applications like Restaurants, Offices, Data Closets / IT rooms.

### Wi-Fi®

Wi-Fi® connectivity is available (see below.)

## CONTROLS

Wireless Remote Controller included with indoor unit

Optional Wired Remote Controller KSACNo401AAA  
(7-Day programmable)



**Wireless Remote Controller**



**Wired Controller (7-Day Programmable)  
KSACNo401AAA**

## ACCESSORIES

Wi-Fi® Kit KSAIFo601AAA



24V Interface for third-party thermostat compatibility KSAICo401230



**SPECIFICATIONS:**

| <b>DLFPHA High Wall</b>            |              |                                       |                     |
|------------------------------------|--------------|---------------------------------------|---------------------|
| <b>Heat Pump</b>                   |              |                                       |                     |
| <b>System</b>                      |              |                                       |                     |
| Size                               |              | 18                                    | 24                  |
| Indoor Model                       |              | DLFPHAH18XAK                          | DLFPHAH24XAK        |
| <b>Electrical</b>                  |              |                                       |                     |
| Voltage-Phase-Cycle                | V-Ph-Hz      | 208/230-1-60                          | 208/230-1-60        |
| Power Supply                       |              | Indoor unit powered from outdoor unit |                     |
| MCA                                | A.           | 0.5                                   | 0.5                 |
| <b>Operating Range</b>             |              |                                       |                     |
| Cooling Indoor DB Min - Max        | ° F (° C)    | 62~90 (17~32)                         | 62~90 (17~32)       |
| Heating Indoor DB Min - Max        | ° F (° C)    | 32~86 (0~30)                          | 32~86 (0~30)        |
| <b>Piping</b>                      |              |                                       |                     |
| Pipe Connection Size - Liquid      | in (mm)      | 3/8" (9.52)                           | 3/8" (9.52)         |
| Pipe Connection Size - Suction     | in (mm)      | 5/8" (15.9)                           | 5/8" (15.9)         |
| <b>Indoor</b>                      |              |                                       |                     |
| Unit Width                         | in (mm)      | 49.57 (1259)                          | 49.57 (1259)        |
| Unit Height                        | in (mm)      | 14.25 (362)                           | 14.25 (362)         |
| Unit Depth                         | in (mm)      | 11.10 (282)                           | 11.10 (282)         |
| Net Weight                         | lbs (kg)     | 43.4 (19.7)                           | 43.4 (19.7)         |
| Number of Fan Speeds               |              | 4                                     | 4                   |
| Airflow (lowest to highest)        | CFM          | 261/389/528/926                       | 359/470/583/926     |
| Sound Pressure (lowest to highest) | dB(A)        | 35.1/40.8/46.1/55.9                   | 36.1/43.3/46.4/56.5 |
| Air Throw Data                     | ft (m)       | 28.80 (8.7)                           | 31.66 (9.65)        |
| Moisture removal                   | Pint/h (L/h) | 3.8 (1.8)                             | 5.0 (2.39)          |
| Field Drain Pipe Size O.D.         | in (mm)      | 1 (25.4)                              | 1 (25.4)            |

**COMPATIBILITY:**

|                           |              |              |
|---------------------------|--------------|--------------|
| Indoor Unit               | DLFPHAH18XAK | DLFPHAH24XAK |
| Outdoor Unit Single Zone* | DLCPPAH18AAK | DLCPPAH24AAK |

\*Performance may vary based on the compatible outdoor units. See respective pages for performance data.

**Note:** Indoor units sizes 18-24 not Compatible With Multi-Zone due to the size of the indoor unit coil.



# A Versatile Outdoor Unit for Maximum Efficiency

## OUTDOOR FEATURES

- 100% Heating capacity at 5° F (-15° C) sizes 12-18 (208/230V)
- Available in 115V and 208/230V
- Built-in basepan heater
- Auto-restart function
- Condenser high-temperature protection
- Refrigerant leakage detection
- Quiet outdoor operation, as low as 54.6 dB(A)
- Anti-corrosive fin coating
- Piping length 82 ~ 164 ft. (25 ~ 50 m.)
- Cooling operating range -13° ~ 122° F (-25° ~ 50° C)
- Heating operating range -22° ~ 86° F (-30° ~ 30° C) Sizes 09-24 (208/230V)  
-13° ~ 86° F (-25° ~ 30° C) Sizes 09, 12 (115V) & 30, 36 (208/230V)

## COMPATIBLE WITH:

- DLFSHA High Wall (p 25)
- DLFSCA Cassette (p 27)
- DLFSDA Ducted (p 29)
- DLFSFA Console (p 31)

## Heat Pump with Basepan Heater

Inverter Compressor

Up to 24.7 SEER

Up to 11.0 HSPF

Sizes: 09 / 12 / 18 / 24 / 30 / 36

Select sizes are ENERGY STAR® certified based on outdoor unit pairing



## KEY FEATURES

### Extra Low Temperature Heating

When it's cold outside, the heat output for this system is up to 69% of rated capacity down to -22° F (-30° C), making this a primary heat source and eliminating the need for a backup heat source.

### Stepless Frequency Adjustment

Precise control of the system maintains a stable and constant room temperature while reducing sound level and saving energy.

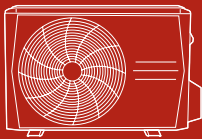

**PERFORMANCE:**

| DLFSHA High Wall                 |       |              |              |              |              |              |              |              |
|----------------------------------|-------|--------------|--------------|--------------|--------------|--------------|--------------|--------------|
| Indoor Model                     |       | DLFSAH12XAJ  | DLFSAH09XAK  | DLFSAH12XAK  | DLFSAH18XAK  | DLFSAH24XAK  | DLFSAH30XAK  | DLFSAH36XAK  |
| <b>ENERGY STAR®</b>              |       | YES          | YES          | YES          | YES          | YES          | YES          | NO           |
| Cooling System Tons              |       | 1.0          | 0.75         | 1.0          | 1.5          | 2.0          | 2.5          | 3.0          |
| Cooling Rated Capacity           | Btu/h | 12,000       | 9,000        | 12,000       | 18,000       | 24,000       | 30,000       | 36,000       |
| Cooling Cap. Range Min - Max     | Btu/h | 3,500~12,200 | 3,500~12,600 | 4,200~12,900 | 4,300~21,200 | 5,200~23,000 | 8,000~32,500 | 8,000~37,800 |
| SEER                             |       | 20.4         | 24.7         | 21.5         | 22.0         | 20.0         | 20.0         | 18.0         |
| EER                              |       | 12.5         | 14.0         | 12.5         | 12.5         | 12.5         | 12.5         | 10.5         |
| Heating Rated Capacity (47° F)   | Btu/h | 11,800       | 12,000       | 12,000       | 18,000       | 25,000       | 30,000       | 36,000       |
| Heating Rated Capacity (17° F)   | Btu/h | 7,200        | 7,500        | 7,600        | 11,900       | 15,000       | 18,000       | 21,000       |
| Heating Maximum Capacity (17° F) | Btu/h | 8,000        | 12,400       | 12,800       | 21,500       | 22,700       | 25,300       | 29,700       |
| Heating Maximum Capacity (5° F)  | Btu/h | 7,800        | 10,700       | 12,100       | 20,700       | 23,300       | 19,500       | 23,400       |
| Heating Cap. Range Min - Max     | Btu/h | 1,300~12,400 | 1,300~14,500 | 1,400~13,900 | 2,900~22,900 | 2,300~26,800 | 2,600~30,400 | 2,700~36,000 |
| HSPF                             |       | 11.0         | 10.5         | 11.0         | 10.5         | 10.0         | 9.8          | 10.0         |
| COP (47° F)                      | W/W   | 3.20         | 3.17         | 3.20         | 3.22         | 2.93         | 3.52         | 3.44         |
| COP (17° F)                      | W/W   | 2.60         | 2.65         | 2.40         | 2.50         | 2.35         | 2.55         | 2.60         |
| COP (5° F)                       | W/W   | 1.97         | 1.60         | 1.60         | 1.60         | 1.70         | 1.64         | 1.50         |

**PERFORMANCE:**

| DLFSCA Cassette                  |       |              |              |              |               |
|----------------------------------|-------|--------------|--------------|--------------|---------------|
| Indoor Model                     |       | DLFSCAH09XAK | DLFSCAH12XAK | DLFSCAH18XAK | DLFSCAH24XAK  |
| <b>ENERGY STAR®</b>              |       | YES          | YES          | YES          | NO            |
| Cooling System Tons              |       | 0.75         | 1.0          | 1.4          | 2.0           |
| Cooling Rated Capacity           | Btu/h | 9,000        | 12,000       | 16,000       | 24,000        |
| Cooling Cap. Range Min - Max     | Btu/h | 3,000~13,000 | 3,300~12,000 | 6,000~18,700 | 11,000~28,600 |
| SEER                             |       | 20.0         | 19.5         | 20.0         | 20.0          |
| EER                              |       | 13.0         | 12.5         | 12.5         | 11.0          |
| Heating Rated Capacity (47° F)   | Btu/h | 10,000       | 12,000       | 18,000       | 24,000        |
| Heating Rated Capacity (17° F)   | Btu/h | 6,700        | 8,200        | 12,000       | 16,200        |
| Heating Maximum Capacity (17° F) | Btu/h | 14,300       | 14,700       | 22,700       | 31,700        |
| Heating Maximum Capacity (5° F)  | Btu/h | 12,200       | 12,300       | 20,000       | 30,000        |
| Heating Cap. Range Min - Max     | Btu/h | 4,000~15,200 | 3,300~15,000 | 8,900~21,400 | 10,200~33,600 |
| HSPF                             |       | 10.2         | 10.2         | 10.5         | 11.5          |
| COP (47° F)                      | W/W   | 3.37         | 3.55         | 2.95         | 3.66          |
| COP (17° F)                      | W/W   | 2.57         | 2.43         | 2.58         | 2.97          |
| COP (5° F)                       | W/W   | 1.71         | 1.70         | 1.45         | 1.93          |

**DLCSRA OUTDOOR UNIT**

**PERFORMANCE:**

| DLFSDA Ducted                    |       |              |              |              |               |
|----------------------------------|-------|--------------|--------------|--------------|---------------|
| Indoor Model                     |       | DLFSDAH09XAK | DLFSDAH12XAK | DLFSDAH18XAK | DLFSDAH24XAK  |
| ENERGY STAR®                     |       | YES          | YES          | YES          | YES           |
| Cooling System Tons              |       | 0.75         | 1.0          | 1.4          | 2.0           |
| Cooling Rated Capacity           | Btu/h | 9,000        | 12,000       | 16,500       | 24,000        |
| Cooling Cap. Range Min - Max     | Btu/h | 3,000~13,000 | 3,300~12,000 | 6,000~18,700 | 11,000~28,700 |
| SEER                             |       | 22.5         | 20.5         | 20.0         | 21.0          |
| EER                              |       | 14.0         | 12.5         | 12.5         | 12.5          |
| Heating Rated Capacity (47° F)   | Btu/h | 10,000       | 12,500       | 19,000       | 24,000        |
| Heating Rated Capacity (17° F)   | Btu/h | 6,800        | 8,100        | 12,400       | 17,400        |
| Heating Maximum Capacity (17° F) | Btu/h | 14,300       | 14,700       | 22,700       | 31,700        |
| Heating Maximum Capacity (5° F)  | Btu/h | 12,200       | 12,300       | 20,000       | 30,000        |
| Heating Cap. Range Min - Max     | Btu/h | 4,000~15,200 | 3,300~15,000 | 8,900~21,400 | 10,200~33,600 |
| HSPF                             |       | 11.5         | 11.0         | 10.8         | 12.0          |
| COP (47° F)                      | W/W   | 3.37         | 3.55         | 2.95         | 3.66          |
| COP (17° F)                      | W/W   | 2.57         | 2.43         | 2.58         | 2.97          |
| COP (5° F)                       | W/W   | 1.71         | 1.70         | 1.45         | 1.93          |

**PERFORMANCE:**

| DLFSFA Console                   |       |              |              |               |
|----------------------------------|-------|--------------|--------------|---------------|
| Indoor Model                     |       | DLFSFAH12XAK | DLFSFAH18XAK | DLFSFAH24XAK  |
| ENERGY STAR®                     |       | YES          | YES          | NO            |
| Cooling System Tons              |       | 1.0          | 1.4          | 2.0           |
| Cooling Rated Capacity           | Btu/h | 12,000       | 17,000       | 24,000        |
| Cooling Cap. Range Min - Max     | Btu/h | 4,200~13,100 | 6,600~20,600 | 11,000~29,200 |
| SEER                             |       | 19.4         | 19.9         | 20.0          |
| EER                              |       | 12.5         | 12.5         | 11.5          |
| Heating Rated Capacity (47° F)   | Btu/h | 12,000       | 18,000       | 24,000        |
| Heating Rated Capacity (17° F)   | Btu/h | 9,600        | 12,900       | 17,200        |
| Heating Maximum Capacity (17° F) | Btu/h | 13,500       | 21,500       | 27,950        |
| Heating Maximum Capacity (5° F)  | Btu/h | 12,300       | 18,700       | 25,000        |
| Heating Cap. Range Min - Max     | Btu/h | 4,800~13,600 | 9,000~22,300 | 10,200~18,400 |
| HSPF                             |       | 10.5         | 10.2         | 11.5          |
| COP (47° F)                      | W/W   | 3.43         | 3.48         | 3.66          |
| COP (17° F)                      | W/W   | 2.66         | 2.30         | 2.80          |
| COP (5° F)                       | W/W   | 1.62         | 1.60         | 1.67          |

Manufacturer reserves the right to discontinue, or change at any time, specification or designs without notice or incurring obligations.



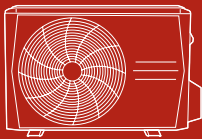

**SPECIFICATIONS:**

| DLCSRA Outdoor Unit            |           |                  |                  |                  |                  |                  |                  |                  |
|--------------------------------|-----------|------------------|------------------|------------------|------------------|------------------|------------------|------------------|
| Heat Pump                      |           |                  |                  |                  |                  |                  |                  |                  |
| System                         |           |                  |                  |                  |                  |                  |                  |                  |
| Size                           |           | 12               | 9                | 12               | 18               | 24               | 30               | 36               |
| Outdoor Model                  |           | DLCSRAH12AAJ     | DLCSRAH09AAK     | DLCSRAH12AAK     | DLCSRAH18AAK     | DLCSRAH24AAK     | DLCSRAH30AAK     | DLCSRAH36AAK     |
| Electrical                     |           |                  |                  |                  |                  |                  |                  |                  |
| Voltage-Phase-Cycle            | V-Ph-Hz   | 115-1-60         | 208/230-1-60     | 208/230-1-60     | 208/230-1-60     | 208/230-1-60     | 208/230-1-60     | 208/230-1-60     |
| MCA                            | A.        | 15               | 9                | 9                | 17               | 20               | 20               | 25               |
| MOC                            | A.        | 20               | 15               | 15               | 25               | 30               | 30               | 35               |
| Operating Range                |           |                  |                  |                  |                  |                  |                  |                  |
| Cooling Outdoor DB Min - Max   | ° F (° C) | -13~122 (-25~50) | -13~122 (-25~50) | -13~122 (-25~50) | -13~122 (-25~50) | -13~122 (-25~50) | -13~122 (-25~50) | -13~122 (-25~50) |
| Heating Outdoor DB Min - Max   | ° F (° C) | -13~86 (-25~30)  | -22~86 (-30~30)  | -22~86 (-30~30)  | -22~86 (-30~30)  | -22~86 (-30~30)  | -13~86 (-25~30)  | -13~86 (-25~30)  |
| Piping                         |           |                  |                  |                  |                  |                  |                  |                  |
| Total Piping Length            | in (mm)   | 82 (25)          | 82 (25)          | 82 (25)          | 98 (30)          | 98 (30)          | 164 (50)         | 164 (50)         |
| Piping Lift*                   | in (mm)   | 32 (10)          | 32 (10)          | 32 (10)          | 66 (20)          | 66 (20)          | 82 (25)          | 82 (25)          |
| Pipe Connection Size - Liquid  | in (mm)   | 1/4 (6.35)       | 1/4 (6.35)       | 1/4 (6.35)       | 1/4 (6.35)       | 3/8 (9.52)       | 3/8 (9.52)       | 3/8 (9.52)       |
| Pipe Connection Size - Suction | in (mm)   | 1/2 (12.7)       | 3/8 (9.52)       | 1/2 (12.7)       | 1/2 (12.7)       | 5/8 (16)         | 5/8 (16)         | 5/8 (16)         |
| Refrigerant                    |           |                  |                  |                  |                  |                  |                  |                  |
| Type                           | in (mm)   | R410A            | R410A            | R410A            | R410A            | R410A            | R410A            | R410A            |
| Charge                         | lbs (kg)  | 2.64 (1.15)      | 3.31 (1.5)       | 3.31 (1.5)       | 4.3 (1.95)       | 5.73 (2.6)       | 6.06 (2.75)      | 7.49 (3.4)       |
| Outdoor                        |           |                  |                  |                  |                  |                  |                  |                  |
| Unit Width                     | in (mm)   | 31.5 (800)       | 31.5 (800)       | 31.5 (800)       | 33.27 (845)      | 37.24 (946)      | 37.24 (946)      | 37.24 (946)      |
| Unit Height                    | in (mm)   | 21.81 (554)      | 21.81 (554)      | 21.81 (554)      | 27.63 (702)      | 31.89 (810)      | 31.89 (810)      | 31.89 (810)      |
| Unit Depth                     | in (mm)   | 13.11 (333)      | 13.11 (333)      | 13.11 (333)      | 14.26 (363)      | 16.54 (420)      | 16.54 (420)      | 16.54 (420)      |
| Net Weight                     | lbs (kg)  | 80.7 (36.6)      | 90.8 (41.2)      | 91.7 (41.6)      | 113.3 (51.4)     | 141.1 (64)       | 137.8 (62.5)     | 143.3 (65)       |
| Airflow                        | CFM       | 1,177            | 1,177            | 1,177            | 1,824            | 2,355            | 2,119            | 2,119            |
| Sound Pressure                 | dB(A)     | 54.7             | 56.6             | 54.6             | 58.9             | 61.0             | 60.0             | 60.0             |

\*Condensing unit above or below indoor unit.

**COMPATIBILITY:**

| Indoor Unit      | DLCSRA Outdoor Unit |              |              |              |              |              |              |
|------------------|---------------------|--------------|--------------|--------------|--------------|--------------|--------------|
|                  | DLCSRAH12AAJ        | DLCSRAH09AAK | DLCSRAH12AAK | DLCSRAH18AAK | DLCSRAH24AAK | DLCSRAH30AAK | DLCSRAH36AAK |
| DLFSHA High Wall | DLFSAH12XAJ         | DLFSAH09XAK  | DLFSAH12XAK  | DLFSAH18XAK  | DLFSAH24XAK  | DLFSAH30XAK  | DLFSAH36XAK  |
| DLFSCA Cassette* |                     | DLFSCAH09XAK | DLFSCAH12XAK | DLFSCAH18XAK | DLFSCAH24XAK |              |              |
| DLFSDA Ducted*   |                     | DLFSDAH09XAK | DLFSDAH12XAK | DLFSDAH18XAK | DLFSDAH24XAK |              |              |
| DLFSFA Console*  |                     |              | DLFSFAH12XAK | DLFSFAH18XAK | DLFSFAH24XAK |              |              |

\*Cassette, Ducted and Console indoor units sizes 36, 48 & 58 ONLY Compatible with DLCLRA Outdoor Unit.



# Built-In Temperature Control for Ultimate Energy Savings

## INDOOR FEATURES

- Available in 115V and 208/230V
- Up to 24.7 SEER and 11.0 HSPF when paired with the DLCSRA outdoor unit
- Modes: Cool, Heat, Dry, Fan, Auto
- Turbo Mode
- Four fan speeds
- Sleep Mode
- ECO Mode
- Up-down louver control (fixed or swing)
- Follow Me (senses temperature at handheld remote)
- Heating Setback (46° F Heating Mode)
- Quiet indoor operation, as low as 25 dB(A)
- Anti-corrosive fin coating

## COMPATIBLE WITH:

- DLCSRA Outdoor Unit Single Zone (p 21)
- DLMRA Outdoor Unit Multi-Zone (p 45)

Sizes: 09 / 12 / 18 / 24 / 30 / 36

Select sizes are ENERGY STAR® certified based on outdoor unit pairing



## KEY FEATURES

### ECO Mode

The intelligent 8-hour night cycle program saves up to 60% of energy to make it more comfortable at night while sleeping.

### Follow Me

Built-in temperature sensor in the Remote Controller will sense its surrounding temperature and adjust the room temperature more accurately to provide greater comfort.

## CONTROLS

Wireless Remote Controller included with indoor unit

Optional Wired Remote Controller KSACN0101AAA (Timer Function)

Optional Wired Remote Controller KSACN0401AAA (7-Day Programmable)



**Wireless Remote Controller**



**Wired Controller (Timer Function) KSACN0101AAA**

## ACCESSORIES

Wi-Fi® Kit KSAIF0501AAA



24V Interface for third-party thermostat compatibility KSAICo401230



**SPECIFICATIONS:**

| DLFSA High Wall                    |              |                                       |                 |                 |                 |                 |                 |                 |
|------------------------------------|--------------|---------------------------------------|-----------------|-----------------|-----------------|-----------------|-----------------|-----------------|
| Heat Pump                          |              |                                       |                 |                 |                 |                 |                 |                 |
| System                             |              |                                       |                 |                 |                 |                 |                 |                 |
| Size                               |              | 12                                    | 9               | 12              | 18              | 24              | 30              | 36              |
| Indoor Model                       |              | DLFSAH12XAJ                           | DLFSAH09XAK     | DLFSAH12XAK     | DLFSAH18XAK     | DLFSAH24XAK     | DLFSAH30XAK     | DLFSAH36XAK     |
| Electrical                         |              |                                       |                 |                 |                 |                 |                 |                 |
| Voltage-Phase-Cycle                | V-Ph-Hz      | 115-1-60                              | 208/230-1-60    | 208/230-1-60    | 208/230-1-60    | 208/230-1-60    | 208/230-1-60    | 208/230-1-60    |
| Power Supply                       |              | Indoor unit powered from outdoor unit |                 |                 |                 |                 |                 |                 |
| MCA                                | A.           | 0.3                                   | 0.2             | 0.2             | 0.22            | 0.25            | 0.5             | 0.5             |
| Operating Range                    |              |                                       |                 |                 |                 |                 |                 |                 |
| Cooling Indoor DB Min - Max        | ° F (° C)    | 62~90 (17~32)                         | 62~90 (17~32)   | 62~90 (17~32)   | 62~90 (17~32)   | 62~90 (17~32)   | 62~90 (17~32)   | 62~90 (17~32)   |
| Heating Indoor DB Min - Max        | ° F (° C)    | 32~86 (0~30)                          | 32~86 (0~30)    | 32~86 (0~30)    | 32~86 (0~30)    | 32~86 (0~30)    | 32~86 (0~30)    | 32~86 (0~30)    |
| Piping                             |              |                                       |                 |                 |                 |                 |                 |                 |
| Pipe Connection Size - Liquid      | in (mm)      | 1/4 (6.35)                            | 1/4 (6.35)      | 1/4 (6.35)      | 1/4 (6.35)      | 3/8 (9.52)      | 3/8 (9.52)      | 3/8 (9.52)      |
| Pipe Connection Size - Suction     | in (mm)      | 1/2 (12.7)                            | 3/8 (9.52)      | 1/2 (12.7)      | 1/2 (12.7)      | 5/8 (16)        | 5/8 (16)        | 5/8 (16)        |
| Indoor                             |              |                                       |                 |                 |                 |                 |                 |                 |
| Unit Width                         | in (mm)      | 31.89 (810)                           | 31.89 (810)     | 31.89 (810)     | 42.91 (1090)    | 42.91 (1090)    | 53.15 (1350)    | 53.15 (1350)    |
| Unit Height                        | in (mm)      | 11.81 (300)                           | 11.81 (300)     | 11.81 (300)     | 13.31 (338)     | 13.31 (338)     | 14.37 (365)     | 14.37 (365)     |
| Unit Depth                         | in (mm)      | 7.87 (200)                            | 7.87 (200)      | 7.87 (200)      | 9.25 (235)      | 9.25 (235)      | 10.71 (272)     | 10.71 (272)     |
| Net Weight                         | lbs (kg)     | 18.7 (8.5)                            | 18.3 (8.3)      | 18.3 (8.3)      | 29.8 (13.5)     | 29.8 (13.5)     | 46.3 (21)       | 46.3 (21)       |
| Number of Fan Speeds               |              | 4                                     | 4               | 4               | 4               | 4               | 4               | 4               |
| Airflow (lowest to highest)        | CFM          | 159/254/295/324                       | 159/254/295/324 | 147/235/294/324 | 353/500/618/647 | 324/471/618/647 | 441/618/882/912 | 441/618/882/912 |
| Sound Pressure (lowest to highest) | dB(A)        | 25.3/32.6/39.1                        | 24.7/32.1/39.8  | 26.1/33/41      | 33.9/41.7/47    | 34.8/42.9/49.1  | 33/44/51        | 33/44/51        |
| Air Throw Data                     | ft (m)       | 22.93 (6.99)                          | 21.75 (6.63)    | 22.93 (6.99)    | 24.93 (7.6)     | 28.54 (8.7)     | 49.2 (15)       | 49.2 (15)       |
| Moisture Removal                   | Pint/h (L/h) | 3.3 (1.56)                            | 1.5 (0.7)       | 3.2 (1.51)      | 2.9 (1.38)      | 5.6 (2.67)      | 6.5 (3.09)      | 8.8 (4.17)      |
| Field Drain Pipe Size O.D.         | in (mm)      | 0.625 (16)                            | 0.625 (16)      | 0.625 (16)      | 0.625 (16)      | 0.625 (16)      | 0.625 (16)      | 0.625 (16)      |

**COMPATIBILITY:**

|                           |              |              |              |              |              |              |              |
|---------------------------|--------------|--------------|--------------|--------------|--------------|--------------|--------------|
| Indoor Unit               | DLFSAH12XAJ  | DLFSAH09XAK  | DLFSAH12XAK  | DLFSAH18XAK  | DLFSAH24XAK  | DLFSAH30XAK  | DLFSAH36XAK  |
| Outdoor Unit Single Zone* | DLCSRAH12AAJ | DLCSRAH09AAK | DLCSRAH12AAK | DLCSRAH18AAK | DLCSRAH24AAK | DLCSRAH30AAK | DLCSRAH36AAK |
| Outdoor Unit Multi-Zone*  |              | DLCMRAH18BAK |              |              |              |              |              |
|                           |              | DLCMRAH27CAK |              |              |              |              |              |
|                           |              | DLCMRAH36DAK |              |              |              |              |              |
|                           |              | DLCMRAH48EAK |              |              |              |              |              |

\*Performance may vary based on the compatible outdoor units. See respective pages for performance data.



# Maximum Flexibility for Optimal Comfort Control

## INDOOR FEATURES

- Available in 208/230V
- Up to 22.5 SEER and 12.0 HSPF when paired with DLCSRA outdoor unit
- Modes: Cool, Heat, Dry, Fan, Auto
- Auto-restart function
- Louver control (fixed or swing)
- Three fan speeds
- Outside air intake
- Built-in condensate lift pump
- Follow Me (senses temperature at handheld remote)
- Heating Setback (46° F Heating Mode)
- Quiet indoor operation, as low as 27 dB(A)
- Anti-corrosive fin coating
- Grille/ceiling panel 2' x 2' sizes 09 to 18 KSALG0101AAA
- Grille/ceiling panel 3' x 3' size 24 KSALG0201AAA

## COMPATIBLE WITH:

- DLCSRA Outdoor Unit Single Zone (p 21)
- DLMRA Outdoor Unit Multi-Zone (p 45)

Sizes: 09 / 12 / 18 / 24

Select sizes are ENERGY STAR® certified based on outdoor unit pairing



## KEY FEATURES

### Built-In Condensate Lift Pump

The Cassette is supplied with a condensate lift pump that is capable of lifting the water 29.5 in. (750 mm.) above the top of the unit.

### Integrated Electrical Components

Easy maintenance with the circuit box inside the unit, provides a more compact size for easier installation.

## CONTROLS

Wireless Remote Controller included with indoor unit

Optional Wired Remote Controller KSACN0101AAA (Timer Function)

Wired Remote Controller KSACN0501AAA (7-Day Programmable)



**Wireless Remote Controller**



**Wired Controller (Timer Function) KSACN0101AAA**



**Wired Controller (7-Day Programmable) KSACN0501AAA**

## ACCESSORIES

Wi-Fi® Kit KSAIF0401AAA

24V Interface for third-party

thermostat compatibility KSAIC0401230



**NOTE:** Grille is required; sold separately.



**SPECIFICATIONS:**

| <b>DLFSCA Cassette</b>             |              |                                       |               |               |               |
|------------------------------------|--------------|---------------------------------------|---------------|---------------|---------------|
| <b>Heat Pump</b>                   |              |                                       |               |               |               |
| <b>System</b>                      |              |                                       |               |               |               |
| Size                               |              | 9                                     | 12            | 18            | 24            |
| Indoor Model                       |              | DLFSCAH09XAK                          | DLFSCAH12XAK  | DLFSCAH18XAK  | DLFSCAH24XAK  |
| <b>Electrical</b>                  |              |                                       |               |               |               |
| Voltage-Phase-Cycle                | V-Ph-Hz      | 208/230-1-60                          | 208/230-1-60  | 208/230-1-60  | 208/230-1-60  |
| Power Supply                       |              | Indoor unit powered from outdoor unit |               |               |               |
| MCA                                | A.           | 0.2                                   | 0.2           | 0.2           | 0.3           |
| <b>Operating Range</b>             |              |                                       |               |               |               |
| Cooling Indoor DB Min - Max        | ° F (° C)    | 62~90 (17~32)                         | 62~90 (17~32) | 62~90 (17~32) | 62~90 (17~32) |
| Heating Indoor DB Min - Max        | ° F (° C)    | 32~86 (0~30)                          | 32~86 (0~30)  | 32~86 (0~30)  | 32~86 (0~30)  |
| <b>Piping</b>                      |              |                                       |               |               |               |
| Pipe Connection Size - Liquid      | in (mm)      | 1/4 (6.35)                            | 1/4 (6.35)    | 1/4 (6.35)    | 3/8 (9.52)    |
| Pipe Connection Size - Suction     | in (mm)      | 3/8 (9.52)                            | 1/2 (12.7)    | 1/2 (12.7)    | 5/8 (16)      |
| <b>Indoor</b>                      |              |                                       |               |               |               |
| Body Unit Width                    | in (mm)      | 22.44 (570)                           | 22.44 (570)   | 22.44 (570)   | 33.07 (840)   |
| Body Unit Height                   | in (mm)      | 10.24 (260)                           | 10.24 (260)   | 10.24 (260)   | 8.07 (205)    |
| Body Unit Depth                    | in (mm)      | 22.44 (570)                           | 22.44 (570)   | 22.44 (570)   | 33.07 (840)   |
| Body Net Weight                    | lbs (kg)     | 35.27 (16)                            | 35.27 (16)    | 39.68 (18)    | 46.3 (21)     |
| Grille Unit Width                  | in (mm)      | 25.47 (647)                           | 25.47 (647)   | 25.47 (647)   | 37.4 (950)    |
| Grille Unit Height                 | in (mm)      | 1.97 (50)                             | 1.97 (50)     | 1.97 (50)     | 2.17 (55)     |
| Grille Unit Depth                  | in (mm)      | 25.47 (647)                           | 25.47 (647)   | 25.47 (647)   | 37.4 (950)    |
| Grille Net Weight                  | lbs (kg)     | 5.51 (2.5)                            | 5.51 (2.5)    | 5.51 (2.5)    | 11.02 (5)     |
| Number of Fan Speeds               |              | 3                                     | 3             | 3             | 3             |
| Airflow (lowest to highest)        | CFM          | 270/306/353                           | 253/296/350   | 439/485/562   | 625/761/878   |
| Sound Pressure (lowest to highest) | dB(A)        | 33/35/38                              | 27/34/42      | 33/40/46.5    | 47/50/52      |
| Air Throw Data                     | ft (m)       | 23 (7)                                | 23 (7)        | 30 (9)        | 30 (9)        |
| Moisture Removal                   | Pint/h (L/h) | 1.58 (0.75)                           | 2.88 (1.366)  | 4.26 (2.02)   | 5.22 (2.47)   |
| Field Drain Pipe Size O.D.         | in (mm)      | 1 (25.4)                              | 1 (25.4)      | 1 (25.4)      | 1 (25.4)      |

**COMPATIBILITY:**

|                           |               |               |               |               |
|---------------------------|---------------|---------------|---------------|---------------|
| Indoor Unit               | DLFSCAH09XAK  | DLFSCAH12XAK  | DLFSCAH18XAK  | DLFSCAH24XAK  |
| Outdoor Unit Single Zone* | DLCSTRAH09AAK | DLCSTRAH12AAK | DLCSTRAH18AAK | DLCSTRAH24AAK |
| Outdoor Unit Multi-Zone*  | DLCMRAH18BAK  |               |               |               |
|                           | DLCMRAH27CAK  |               |               |               |
|                           | DLCMRAH36DAK  |               |               |               |
|                           | DLCMRAH48EAK  |               |               |               |

\*Performance may vary based on the compatible outdoor units. See respective pages for performance data.



**INDOOR FEATURES**

- Available in 208/230V
- Up to 22.5 SEER and up to 12.0 HSPF when paired with DLCSRA outdoor unit
- Modes: Cool, Heat, Dry, Fan, Auto
- Vertical or horizontal installation
- Up to 0.64 in WG
- Rear or bottom return
- Variable CFM Operation
- Built-in condensate lift pump
- Follow Me (senses temperature at handheld remote)
- Heating Setback (46° F Heating Mode)
- Quiet indoor operation, as low as 30 dB(A)
- Anti-corrosive fin coating

**COMPATIBLE WITH:**

- DLCSRA Outdoor Unit Single Zone (p 21)
- DLCMRA Outdoor Unit Multi-Zone (p 45)

# Flexible Installation & Increased Air Circulation

Sizes: 09 / 12 / 18 / 24

Select sizes are ENERGY STAR® certified based on outdoor unit pairing



**KEY FEATURES**

**Vertical or Horizontal Installation**

Designed for maximum installation flexibility with the built-in secondary drain pan, which allows the unit to be mounted vertically for either a floor- or ceiling-concealed installation depending on existing conditions.

**Built-In Condensate Lift Pump**

Supplied with a condensate lift pump that is capable of lifting the water a maximum of 29.5 in. (750 mm.) above the top of the unit.

**CONTROLS**

Wireless Remote Controller included with indoor unit

Optional Wired Remote Controller KSACN0101AAA (Timer Function)

Wired Remote Controller KSACN0501AAA (7-Day Programmable) included with indoor unit



**Wireless Remote Controller**



**Wired Controller (Timer Function) KSACN0101AAA**



**Wired Controller (7-Day Programmable) KSACN0501AAA**

**ACCESSORIES**



Wi-Fi® Kit KSAIF0401AAA

24V Interface for third-party thermostat compatibility KSAICo401230



**SPECIFICATIONS:**

| <b>DLFSDA Ducted</b>               |           |                                       |               |               |               |
|------------------------------------|-----------|---------------------------------------|---------------|---------------|---------------|
| <b>Heat Pump</b>                   |           |                                       |               |               |               |
| <b>System</b>                      |           |                                       |               |               |               |
| Size                               |           | 9                                     | 12            | 18            | 24            |
| Indoor Model                       |           | DLFSDAH09XAK                          | DLFSDAH12XAK  | DLFSDAH18XAK  | DLFSDAH24XAK  |
| <b>Electrical</b>                  |           |                                       |               |               |               |
| Voltage-Phase-Cycle                | V-Ph-Hz   | 208/230-1-60                          | 208/230-1-60  | 208/230-1-60  | 208/230-1-60  |
| Power Supply                       |           | Indoor unit powered from outdoor unit |               |               |               |
| MCA                                | A.        | 1.11                                  | 1.11          | 1.2           | 1.2           |
| <b>Operating Range</b>             |           |                                       |               |               |               |
| Cooling Indoor DB Min - Max        | ° F (° C) | 62~90 (17~32)                         | 62~90 (17~32) | 62~90 (17~32) | 62~90 (17~32) |
| Heating Indoor DB Min - Max        | ° F (° C) | 32~86 (0~30)                          | 32~86 (0~30)  | 32~86 (0~30)  | 32~86 (0~30)  |
| <b>Piping</b>                      |           |                                       |               |               |               |
| Pipe Connection Size - Liquid      | in (mm)   | 1/4 (6.35)                            | 1/4 (6.35)    | 1/4 (6.35)    | 3/8 (9.52)    |
| Pipe Connection Size - Suction     | in (mm)   | 3/8 (9.52)                            | 1/2 (12.7)    | 1/2 (12.7)    | 5/8 (16)      |
| <b>Indoor</b>                      |           |                                       |               |               |               |
| Unit Width                         | in (mm)   | 27.56 (700)                           | 27.56 (700)   | 34.65 (880)   | 43.31 (1100)  |
| Unit Height                        | in (mm)   | 7.87 (200)                            | 7.87 (200)    | 8.27 (210)    | 9.8 (249)     |
| Unit Depth                         | in (mm)   | 19.92 (506)                           | 19.92 (506)   | 26.54 (674)   | 30.47 (774)   |
| Net Weight                         | lbs (kg)  | 43.56 (19.8)                          | 43.56 (19.8)  | 54 (24.5)     | 86.86 (39.4)  |
| Number of Fan Speeds               |           | 3                                     | 3             | 3             | 3             |
| Airflow (lowest to highest)        | CFM       | 147/211/264                           | 176/282/353   | 300/400/480   | 440/700/780   |
| Sound Pressure (lowest to highest) | dB(A)     | 30/34/38                              | 35/37/39      | 35/37/39      | 35.5/40/44    |
| Max. Static Pressure               | in (WG)   | 0.20                                  | 0.20          | 0.40          | 0.64          |
| Field Drain Pipe Size O.D.         | in (mm)   | 1 (25.4)                              | 1 (25.4)      | 1 (25.4)      | 1 (25.4)      |

**COMPATIBILITY:**

|                           |              |              |              |              |
|---------------------------|--------------|--------------|--------------|--------------|
| Indoor Unit               | DLFSDAH09XAK | DLFSDAH12XAK | DLFSDAH18XAK | DLFSDAH24XAK |
| Outdoor Unit Single Zone* | DLCSRAH09AAK | DLCSRAH12AAK | DLCSRAH18AAK | DLCSRAH24AAK |
| Outdoor Unit Multi-Zone*  | DLCMRAH18BAK |              |              |              |
|                           | DLCMRAH27CAK |              |              |              |
|                           | DLCMRAH36DAK |              |              |              |
|                           | DLCMRAH48EAK |              |              |              |

\*Performance may vary based on the compatible outdoor units. See respective pages for performance data.



# A Single Console for Optimized Heating & Cooling

## INDOOR FEATURES

- Available in 208/230V
- Up to 22.5 SEER and 12.0 HSPF when paired with DLCSRA outdoor unit
- Modes: Cool, Heat, Dry, Fan, Auto
- Auto-restart function
- Size 12 capable of being mounted on floor only
- Sizes 18-24 capable of being mounted on floor or ceiling
- Louver control (fixed or swing)
- Three fan speeds
- Air discharge from top and bottom (size 12 only)
- Follow Me (senses temperature at handheld remote)
- Heating Setback (46° F Heating Mode)
- Quiet indoor operation, as low as 34 dB(A)
- Anti-corrosive fin coating

## COMPATIBLE WITH:

- DLCSRA Outdoor Unit Single Zone (p 21)
- DLCMRA Outdoor Unit Multi-Zone (p 45)

Sizes: 12 / 18 / 24

Select sizes are ENERGY STAR® certified based on outdoor unit pairing



## KEY FEATURES

### 2-Way Optional Air Outlet

For up and down air-outlet or up air-outlet. Only on size 12.

### Outside Air Intake

Outside air can be brought into the room through the connection available on the indoor unit, which helps meet the ventilation requirement. Only on sizes 18-24.

## CONTROLS

Wireless Remote Controller included with indoor unit

Optional Wired Remote Controller KSACN0101AAA (Timer Function)

Optional Wired Remote Controller KSACN0401AAA (7-Day Programmable) size 12

Optional Wired Remote Controller KSACN0501AAA (7-Day Programmable) sizes 18 and 24



**Wireless Remote Controller**



**Wired Controller (Timer Function) KSACN0101AAA**



**Wired Controller (7-Day Programmable) KSACN0401AAA**

## ACCESSORIES

Wi-Fi® Kit (sizes 18-24) KSAIF0401AAA\*  
24V Interface for third-party thermostat compatibility KSAIC0401230



\*Not available for size 12.





**SPECIFICATIONS:**

| <b>DLFSFA Console</b>              |           |                                       |               |               |
|------------------------------------|-----------|---------------------------------------|---------------|---------------|
| <b>Heat Pump</b>                   |           |                                       |               |               |
| <b>System</b>                      |           |                                       |               |               |
| Size                               |           | 12                                    | 18            | 24            |
| Indoor Model                       |           | DLFSFAH12XAK                          | DLFSFAH18XAK  | DLFSFAH24XAK  |
| <b>Electrical</b>                  |           |                                       |               |               |
| Voltage-Phase-Cycle                | V-Ph-Hz   | 208/230-1-60                          | 208/230-1-60  | 208/230-1-60  |
| Power Supply                       |           | Indoor unit powered from outdoor unit |               |               |
| MCA                                | A.        | 0.3                                   | 1.0           | 1.0           |
| <b>Operating Range</b>             |           |                                       |               |               |
| Cooling Indoor DB Min - Max        | ° F (° C) | 62~90 (17~32)                         | 62~90 (17~32) | 62~90 (17~32) |
| Heating Indoor DB Min - Max        | ° F (° C) | 32~86 (0~30)                          | 32~86 (0~30)  | 32~86 (0~30)  |
| <b>Piping</b>                      |           |                                       |               |               |
| Pipe Connection Size - Liquid      | in (mm)   | 1/4 (6.35)                            | 1/4 (6.35)    | 3/8 (9.52)    |
| Pipe Connection Size - Suction     | in (mm)   | 1/2 (12.7)                            | 1/2 (12.7)    | 5/8 (16)      |
| <b>Indoor</b>                      |           |                                       |               |               |
| Unit Width                         | in (mm)   | 27.56 (700)                           | 42.05 (1068)  | 42.05 (1068)  |
| Unit Height                        | in (mm)   | 23.62 (600)                           | 26.57 (675)   | 26.57 (675)   |
| Unit Depth                         | in (mm)   | 8.27 (210)                            | 9.25 (235)    | 9.25 (235)    |
| Net Weight                         | lbs (kg)  | 32.41 (14.7)                          | 55.12 (25)    | 58.42 (26.5)  |
| Number of Fan Speeds               |           | 3                                     | 3             | 3             |
| Airflow (lowest to highest)        | CFM       | 250/320/360                           | 420/485/550   | 600/710/760   |
| Sound Pressure (lowest to highest) | dB(A)     | 34/41/45                              | 39/44/47      | 46/50/52      |
| Air Throw Data                     | ft (m)    | 23 (7)                                | 26 (8)        | 21.75 (6.63)  |
| Field Drain Pipe Size O.D.         | in (mm)   | 1 (25.4)                              | 1 (25.4)      | 1 (25.4)      |

**COMPATIBILITY:**

|                           |               |               |               |
|---------------------------|---------------|---------------|---------------|
| Indoor Unit               | DLFSFAH12XAK  | DLFSFAH18XAK  | DLFSFAH24XAK  |
| Outdoor Unit Single Zone* | DLCSTRAH12AAK | DLCSTRAH18AAK | DLCSTRAH24AAK |
| Outdoor Unit Multi-Zone*  | DLCMRAH18BAK  |               |               |
|                           | DLCMRAH27CAK  |               |               |
|                           | DLCMRAH36DAK  |               |               |
|                           | DLCMRAH48EAK  |               |               |

\*Performance may vary based on the compatible outdoor units. See respective pages for performance data.



# A Cost-Effective Outdoor Unit for Economical Heating & Cooling

## OUTDOOR FEATURES

- Cost-competitive
- Available in 115V and 208/230V
- Built-in basepan heater on heat pump units
- Auto-restart function
- Condenser high-temperature protection
- Refrigerant leakage detection
- Quiet outdoor operation, as low as 52 dB(A)
- Anti-corrosive fin coating
- Piping length 82 ~ 164 ft. (25-50 m.)
- Cooling operating range 0° ~ 22° F (-17° ~ 50° C)
- Heating operating range 0° ~ 86° F (-17° ~ 30° C)

## COMPATIBLE WITH:

- DLFEHAA High Wall Cooling Only (p 38)
- DLFEHAH High Wall Heat Pump (p 39)

## Cooling Only – DLCERAA

## Heat Pump with Basepan Heater – DLCERAH

Inverter Compressor

Up to 17.6 SEER

Up to 10.6 HSPF

Sizes: 09 / 12 / 18 / 24

## KEY FEATURES

### Cost-Effective

An economical choice that can provide comfort when you need it.

### Rapid Cooling & Heating

After start-up, the compressor quickly gets up to maximum speed, cooling or heating the room in minutes.

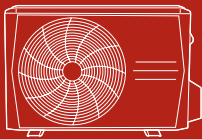

**SPECIFICATIONS:**

| <b>DLCERAH Outdoor Unit</b>    |           |                |                |                |                |                |
|--------------------------------|-----------|----------------|----------------|----------------|----------------|----------------|
| <b>Heat Pump</b>               |           |                |                |                |                |                |
| <b>System</b>                  |           |                |                |                |                |                |
| Size                           |           | 12             | 9              | 12             | 18             | 24             |
| Outdoor Model                  |           | DLCERAH12AAJ   | DLCERAH09AAK   | DLCERAH12AAK   | DLCERAH18AAK   | DLCERAH24AAK   |
| <b>Electrical</b>              |           |                |                |                |                |                |
| Voltage-Phase-Cycle            | V-Ph-Hz   | 115-1-60       | 208/230-1-60   | 208/230-1-60   | 208/230-1-60   | 208/230-1-60   |
| MCA                            | A.        | 13             | 8              | 10             | 15             | 18             |
| MOCP - Fuse Rating             | A.        | 20             | 15             | 15             | 20             | 25             |
| <b>Operating Range</b>         |           |                |                |                |                |                |
| Cooling Outdoor DB Min - Max   | ° F (° C) | 0~122 (-17~50) | 0~122 (-17~50) | 0~122 (-17~50) | 0~122 (-17~50) | 0~122 (-17~50) |
| Heating Outdoor DB Min - Max   | ° F (° C) | 0~86 (-17~30)  | 0~86 (-17~30)  | 0~86 (-17~30)  | 0~86 (-17~30)  | 0~86 (-17~30)  |
| <b>Piping</b>                  |           |                |                |                |                |                |
| Total Piping Length            | ft (m)    | 82 (25)        | 82 (25)        | 82 (25)        | 98 (30)        | 164 (50)       |
| Piping Lift*                   | ft (m)    | 33 (10)        | 33 (10)        | 33 (10)        | 66 (20)        | 66 (20)        |
| Pipe Connection Size - Liquid  | in (mm)   | 1/4 (6.35)     | 1/4 (6.35)     | 1/4 (6.35)     | 1/4 (6.35)     | 3/8 (9.52)     |
| Pipe Connection Size - Suction | in (mm)   | 1/2 (12.7)     | 3/8 (9.52)     | 1/2 (12.7)     | 1/2 (12.7)     | 5/8 (16)       |
| <b>Refrigerant</b>             |           |                |                |                |                |                |
| Type                           |           | R410A          | R410A          | R410A          | R410A          | R410A          |
| Charge                         | lbs (kg)  | 2.11 (0.96)    | 1.76 (0.80)    | 2.11 (0.96)    | 2.82 (1.28)    | 3.97 (1.80)    |
| <b>Outdoor</b>                 |           |                |                |                |                |                |
| Unit Width                     | in (mm)   | 30.31 (770)    | 30.31 (770)    | 30.31 (770)    | 31.50 (800)    | 33.27 (845)    |
| Unit Height                    | in (mm)   | 21.85 (555)    | 21.85 (555)    | 21.85 (555)    | 21.81 (554)    | 27.64 (702)    |
| Unit Depth                     | in (mm)   | 11.81 (300)    | 11.81 (300)    | 11.81 (300)    | 13.11 (333)    | 14.29 (363)    |
| Net Weight                     | lbs (kg)  | 69 (31.3)      | 63 (28.6)      | 65.5 (29.7)    | 79.6 (36.1)    | 114.2 (51.8)   |
| Airflow                        | CFM       | 1,170          | 1,170          | 1,170          | 1,170          | 1,765          |
| Sound Pressure                 | dB(A)     | 54.5           | 57.2           | 57.4           | 57.0           | 60.2           |

\*Condensing unit above or below indoor unit.

**COMPATIBILITY:**

| Indoor Unit       |              | Outdoor Unit |              |              |              |              |
|-------------------|--------------|--------------|--------------|--------------|--------------|--------------|
|                   |              | DLCERAH12AAJ | DLCERAH09AAK | DLCERAH12AAK | DLCERAH18AAK | DLCERAH24AAK |
| DLFEHAH High Wall | DLFEHAH12XAJ | •            |              |              |              |              |
|                   | DLFEHAH09XAK |              | •            |              |              |              |
|                   | DLFEHAH12XAK |              |              | •            |              |              |
|                   | DLFEHAH18XAK |              |              |              | •            |              |
|                   | DLFEHAH24XAK |              |              |              |              | •            |

**PERFORMANCE:**

| <b>DLFEHAH High Wall</b>        |       |              |              |              |              |              |
|---------------------------------|-------|--------------|--------------|--------------|--------------|--------------|
| <b>Heat Pump</b>                |       |              |              |              |              |              |
| Indoor Model                    |       | DLFEHAH12XAJ | DLFEHAH09XAK | DLFEHAH12XAK | DLFEHAH18XAK | DLFEHAH24XAK |
| <b>ENERGY STAR®</b>             |       | <b>NO</b>    | <b>NO</b>    | <b>NO</b>    | <b>NO</b>    | <b>NO</b>    |
| Cooling System Tons             |       | 1.0          | 0.8          | 1.0          | 1.5          | 2.0          |
| Cooling Rated Capacity          | Btu/h | 12,000       | 9,000        | 12,000       | 18,000       | 24,000       |
| Cooling Cap. Range Min - Max    | Btu/h | 3,700-13,000 | 3,400-10,500 | 3,700-13,000 | 5,500-19,000 | 8,987-26,585 |
| SEER                            |       | 17.3         | 17.6         | 17.5         | 17.5         | 16.9         |
| EER                             |       | 10.0         | 11.2         | 11.2         | 11.2         | 9.7          |
| Heating Rated Capacity (47° F)  | Btu/h | 12,000       | 9,800        | 12,000       | 18,000       | 24,800       |
| Heating Rated Capacity (17° F)  | Btu/h | 8,000        | 7,500        | 9,230        | 11,600       | 18,000       |
| Heating Maximum Capacity (5° F) | Btu/h | 9,000        | 6,070        | 8,880        | 10,150       | 16,760       |
| Heating Cap. Range Min - Max    | Btu/h | 3,500-13,500 | 2,800-11,500 | 3,500-13,500 | 6,200-19,000 | 8,371-25,350 |
| HSPF                            |       | 10.6         | 10.0         | 9.6          | 10.6         | 9.6          |
| COP (47° F)                     | W/W   | 2.93         | 3.27         | 3.22         | 3.26         | 3.13         |
| COP (5° F)                      | W/W   | 1.60         | 1.60         | 1.60         | 1.50         | 1.40         |

**PERFORMANCE:**

| <b>DLFEHAA High Wall</b>     |       |              |              |              |              |
|------------------------------|-------|--------------|--------------|--------------|--------------|
| <b>Cooling Only</b>          |       |              |              |              |              |
| Indoor Model                 |       | DLFEHAA12XAJ | DLFEHAA12XAK | DLFEHAA18XAK | DLFEHAA24XAK |
| <b>ENERGY STAR®</b>          |       | <b>NO</b>    | <b>NO</b>    | <b>NO</b>    | <b>NO</b>    |
| Cooling System Tons          |       | 1.0          | 1.0          | 1.5          | 2.0          |
| Cooling Rated Capacity       | Btu/h | 12,000       | 12,000       | 18,000       | 24,000       |
| Cooling Cap. Range Min - Max | Btu/h | 4,800~13,200 | 4,800~13,000 | 5,800~18,600 | 9,400~25,200 |
| SEER                         |       | 16.8         | 16.0         | 16.5         | 17.0         |
| EER                          |       | 10.7         | 11.2         | 10.3         | 10.9         |

**An economical choice that can provide comfort when you need it.**

Manufacturer reserves the right to discontinue, or change at any time, specification or designs without notice or incurring obligations.

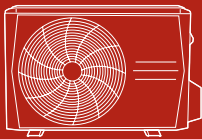

**SPECIFICATIONS:**

| <b>DLCERAA Outdoor Unit</b>    |           |                |                |                |                |
|--------------------------------|-----------|----------------|----------------|----------------|----------------|
| <b>Cooling Only</b>            |           |                |                |                |                |
| <b>System</b>                  |           |                |                |                |                |
| Size                           |           | 12             | 12             | 18             | 24             |
| Outdoor Model                  |           | DLCERAA12AAJ   | DLCERAA12AAK   | DLCERAA18AAK   | DLCERAA24AAK   |
| <b>Electrical</b>              |           |                |                |                |                |
| Voltage-Phase-Cycle            | V-Ph-Hz   | 115-1-60       | 208/230-1-60   | 208/230-1-60   | 208/230-1-60   |
| MCA                            | A.        | 13             | 7              | 11             | 16             |
| MOCP - Fuse Rating             | A.        | 20             | 15             | 15             | 25             |
| <b>Operating Range</b>         |           |                |                |                |                |
| Cooling Outdoor DB Min - Max   | ° F (° C) | 0~122 (-17~50) | 0~122 (-17~50) | 0~122 (-17~50) | 0~122 (-17~50) |
| <b>Piping</b>                  |           |                |                |                |                |
| Total Piping Length            | ft (m)    | 82 (25)        | 82 (25)        | 98 (30)        | 164 (50)       |
| Piping Lift*                   | ft (m)    | 33 (10)        | 33 (10)        | 66 (20)        | 66 (20)        |
| Pipe Connection Size - Liquid  | in (mm)   | 1/4 (6.35)     | 1/4 (6.35)     | 1/4 (6.35)     | 3/8 (9.52)     |
| Pipe Connection Size - Suction | in (mm)   | 1/2 (12.7)     | 1/2 (12.7)     | 1/2 (12.7)     | 5/8 (16)       |
| <b>Refrigerant</b>             |           |                |                |                |                |
| Type                           |           | R410A          | R410A          | R410A          | R410A          |
| Charge                         | lbs (kg)  | 1.30 (0.59)    | 1.30 (0.59)    | 2.09 (0.95)    | 2.64 (1.20)    |
| <b>Outdoor</b>                 |           |                |                |                |                |
| Unit Width                     | in (mm)   | 30.31 (770)    | 30.31 (770)    | 31.50 (800)    | 33.27 (845)    |
| Unit Height                    | in (mm)   | 21.85 (555)    | 21.85 (555)    | 21.81 (554)    | 27.64 (702)    |
| Unit Depth                     | in (mm)   | 11.81 (300)    | 11.81 (300)    | 13.11 (333)    | 14.29 (363)    |
| Net Weight                     | lbs (kg)  | 57.8 (26.2)    | 53.8 (24.4)    | 70.1 (31.8)    | 88.6 (40.2)    |
| Airflow                        | CFM       | 1,170          | 1,170          | 1,170          | 1,880          |
| Sound Pressure                 | dB(A)     | 52.0           | 54.0           | 57.0           | 59.5           |

\*Condensing unit above or below indoor unit.

**COMPATIBILITY:**

| Indoor Unit       |              | Outdoor Unit |              |              |              |
|-------------------|--------------|--------------|--------------|--------------|--------------|
|                   |              | DLCERAA12AAJ | DLCERAA12AAK | DLCERAA18AAK | DLCERAA24AAK |
| DLFEHAA High Wall | DLFEHAA12XAJ | •            |              |              |              |
|                   | DLFEHAA12XAK |              | •            |              |              |
|                   | DLFEHAA18XAK |              |              | •            |              |
|                   | DLFEHAA24XAK |              |              |              | •            |



# Easy Installation for Maximum Convenience & Comfort

## INDOOR FEATURES

- Available in 115V and 208/230V
- Up to 17.6 SEER and up to 10.6 HSPF when paired with DLCERA outdoor unit
- Modes: Cool, Heat, Dry, Fan, Auto
- Turbo Mode
- Up-down louver control (fixed or swing)
- Remove filter from the top
- Improved serviceability
- Four fan speeds
- Sleep Mode
- Follow Me (senses temperature at handheld remote)
- Heating Setback (46° F Heating Mode)
- Quiet indoor operation, as low as 29 dB(A)
- Anti-corrosive fin coating

## COMPATIBLE WITH:

- DLCERA Outdoor Unit Single Zone (p 33)
- DLMRA Outdoor Unit Multi-Zone (p 45)

**Cooling Only – DLFEHAA**

**Heat Pump – DLFEHAH**

Sizes: 09 / 12 / 18 / 24

## KEY FEATURES

### Improved Serviceability

Full access to the terminal connections and fan after lifting the front cover of the High Wall for easy installation and service.

### Convenient Filter Removal

The filter is located on the inlet, allowing for direct removal from the top of the unit without opening the cover.

## CONTROLS

Wireless Remote Controller included with indoor unit

Optional Wired Remote Controller KSACNo401AAA (7-Day Programmable)



**Wireless Remote Controller (7-Day Programmable)**



**Wired Controller KSACNo401AAA**

## ACCESSORIES

Wi-Fi® High Wall Entry Tier 9/12/24 KSAIF0101AAA

Wi-Fi® High Wall Entry Tier 18k Only KSAIF0201AAA

24V Interface for third-party thermostat compatibility KSAICo401230





**SPECIFICATIONS:**

| <b>DLFEHAA High Wall</b>                           |              |                                       |               |                 |                 |
|--|--------------|---------------------------------------|---------------|-----------------|-----------------|
| <b>Cooling Only System</b>                         |              |                                       |               |                 |                 |
| Size   |              | 12                                    | 12            | 18              | 24              |
| Indoor Model                                       |              | DLFEHAA12XAJ                          | DLFEHAA12XAK  | DLFEHAA18XAK    | DLFEHAA24XAK    |
| <b>Electrical</b>                                  |              |                                       |               |                 |                 |
| Voltage-Phase-Cycle                                | V-Ph-Hz      | 115-1-60                              | 208/230-1-60  | 208/230-1-60    | 208/230-1-60    |
| Power Supply                                       |              | Indoor unit powered from outdoor unit |               |                 |                 |
| MCA  | A.           | 0.3                                   | 0.25          | 0.4             | 0.45            |
| <b>Controls</b>                                    |              |                                       |               |                 |                 |
| Wireless Remote Controller (° F / ° C Convertible) |              | Standard                              | Standard      | Standard        | Standard        |
| Wired Remote Controller (° F / ° C Convertible)    |              | Optional                              | Optional      | Optional        | Optional        |
| <b>Operating</b>                                   |              |                                       |               |                 |                 |
| Cooling Outdoor DB Min - Max                       | ° F (° C)    | 63~90 (17~32)                         | 63~90 (17~32) | 63~90 (17~32)   | 63~90 (17~32)   |
| <b>Piping</b>                                      |              |                                       |               |                 |                 |
| Pipe Connection Size - Liquid                      | in (mm)      | 1/4 (6.35)                            | 1/4 (6.35)    | 1/4 (6.35)      | 3/8 (9.52)      |
| Pipe Connection Size - Suction                     | in (mm)      | 1/2 (12.7)                            | 1/2 (12.7)    | 1/2 (12.7)      | 5/8 (16)        |
| <b>Indoor</b>                                      |              |                                       |               |                 |                 |
| Unit Width   | in (mm)      | 32.00 (813)                           | 32.00 (813)   | 38.36 (974)     | 43.83 (1113)    |
| Unit Height  | in (mm)      | 11.81 (300)                           | 11.81 (300)   | 12.8 (325)      | 13.41 (341)     |
| Unit Depth   | in (mm)      | 7.75 (197)                            | 7.75 (197)    | 8.87 (225)      | 9.22 (234)      |
| Net Weight   | lbs (kg)     | 17.64 (8)                             | 17.64 (8)     | 23.15 (10.5)    | 30.86 (14)      |
| Number of Fan Speeds                               |              | 4                                     | 4             | 4               | 4               |
| Airflow (lowest to highest)                        | CFM          | 190/239/301/328                       | 188/238/305   | 344/422/506/550 | 420/514/609/640 |
| Sound Pressure (lowest to highest)                 | dB(A)        | 29/36/41/42                           | 28/35/40/42   | 34/39/43/45     | 39/44/49/49     |
| Air Throw Data                                     | ft (m)       | 22 (6.7)                              | 22 (6.7)      | 24 (7.3)        | 39.4 (12)       |
| Moisture Removal                                   | Pint/h (L/h) | 3.17 (1.50)                           | 3.09 (1.46)   | 4.61 (2.18)     | 6.38 (3.02)     |
| Field Drain Pipe Size O.D.                         | in (mm)      | 0.625 (16)                            | 0.625 (16)    | 0.625 (16)      | 0.625 (16)      |

\*Compatibility tables on next page.

**SPECIFICATIONS:**

| <b>DLFEHAH High Wall</b>                              |                 |                                       |                     |                     |                     |                     |
|---|-----------------|---------------------------------------|---------------------|---------------------|---------------------|---------------------|
| <b>Heat Pump</b>                                      |                 |                                       |                     |                     |                     |                     |
| <b>System</b>   |                 |                                       |                     |                     |                     |                     |
| Size  |                 | 12                                    | 9                   | 12                  | 18                  | 24                  |
| Indoor Model  |                 | DLFEHAH12XAJ                          | DLFEHAH09XAK        | DLFEHAH12XAK        | DLFEHAH18XAK        | DLFEHAH24XAK        |
| <b>Electrical</b>                                     |                 |                                       |                     |                     |                     |                     |
| Voltage-Phase-Cycle                                   | V-Ph-Hz         | 115-1-60                              | 208/230-1-60        | 208/230-1-60        | 208/230-1-60        | 208/230-1-60        |
| Power Supply  |                 | Indoor unit powered from outdoor unit |                     |                     |                     |                     |
| MCA   | A.              | 0.3                                   | 0.25                | 0.25                | 0.28                | 0.45                |
| <b>Controls</b>                                       |                 |                                       |                     |                     |                     |                     |
| Wireless Remote Controller<br>(° F / ° C Convertible) |                 | Standard                              | Standard            | Standard            | Standard            | Standard            |
| Wired Remote Controller<br>(° F / ° C Convertible)    |                 | Optional                              | Optional            | Optional            | Optional            | Optional            |
| <b>Operating</b>                                      |                 |                                       |                     |                     |                     |                     |
| Cooling Indoor DB Min - Max                           | ° F (° C)       | 63~90 (17~32)                         | 63~90 (17~32)       | 63~90 (17~32)       | 63~90 (17~32)       | 63~90 (17~32)       |
| Heating Indoor DB Min - Max                           | ° F (° C)       | 32~86 (0~30)                          | 32~86 (0~30)        | 32~86 (0~30)        | 32~86 (0~30)        | 32~86 (0~30)        |
| <b>Piping</b>   |                 |                                       |                     |                     |                     |                     |
| Pipe Connection Size - Liquid                         | in (mm)         | 1/4 (6.35)                            | 1/4 (6.35)          | 1/4 (6.35)          | 1/4 (6.35)          | 3/8 (9.52)          |
| Pipe Connection Size - Suction                        | in (mm)         | 1/2 (12.7)                            | 3/8 (9.52)          | 1/2 (12.7)          | 1/2 (12.7)          | 5/8 (16)            |
| <b>Indoor</b>   |                 |                                       |                     |                     |                     |                     |
| Unit Width  | in (mm)         | 32.00 (813)                           | 28.53 (725)         | 32.00 (813)         | 38.36 (974)         | 43.83 (1113)        |
| Unit Height   | in (mm)         | 11.81 (300)                           | 11.81 (300)         | 11.81 (300)         | 12.8 (325)          | 13.41 (341)         |
| Unit Depth  | in (mm)         | 7.75 (197)                            | 7.75 (197)          | 7.75 (197)          | 8.87 (225)          | 9.22 (234)          |
| Net Weight  | lbs (kg)        | 22.49 (10.2)                          | 21.16 (9.6)         | 22.49 (10.2)        | 31.97 (14.5)        | 40.12 (18.2)        |
| Number of Fan Speeds                                  |                 | 4                                     | 4                   | 4                   | 4                   | 4                   |
| Airflow (lowest to highest)                           | CFM             | 200/265/306/<br>329                   | 165/229/271/<br>324 | 212/282/324/<br>353 | 353/412/529/<br>559 | 353/483/589/<br>647 |
| Sound Pressure (lowest to highest)                    | dB(A)           | 29/38/42/42                           | 31/36/40/42         | 34/39/41/43         | 34/39/44/46         | 38/42/48/49         |
| Air Throw Data  | ft (m)          | 22 (6.7)                              | 20.3 (6.2)          | 22.6 (6.9)          | 25 (7.6)            | 37.7 (11.5)         |
| Moisture Removal                                      | Pint/h<br>(L/h) | 3.49 (1.65)                           | 2.05 (0.97)         | 3.38 (1.6)          | 4.63 (2.19)         | 5.73 (2.71)         |
| Field Drain Pipe Size O.D.                            | in (mm)         | 0.625 (16)                            | 0.625 (16)          | 0.625 (16)          | 0.625 (16)          | 0.625 (16)          |

\*Compatibility tables on next page.





**COMPATIBILITY:**

| <b>Cooling Only</b>       |              |              |              |              |
|---------------------------|--------------|--------------|--------------|--------------|
| Indoor Unit               | DLFEHAA12XAJ | DLFEHAA12XAK | DLFEHAA18XAK | DLFEHAA24XAK |
| Outdoor Unit Single Zone* | DLCERAA12AAJ | DLCERAA12AAK | DLCERAA18AAK | DLCERAA24AAK |
| Outdoor Unit Multi-Zone*  |              |              |              |              |

\*Performance may vary based on the compatible outdoor units. See respective pages for performance data.

**COMPATIBILITY:**

| <b>Heat Pump</b>          |              |              |              |              |              |
|---------------------------|--------------|--------------|--------------|--------------|--------------|
| Indoor Unit               | DLFEHAH12XAJ | DLFEHAH09XAK | DLFEHAH12XAK | DLFEHAH18XAK | DLFEHAH24XAK |
| Outdoor Unit Single Zone* | DLCERAH12AAJ | DLCERAH09AAK | DLCERAH12AAK | DLCERAH18AAK | DLCERAH24AAK |
| Outdoor Unit Multi-Zone*  |              | DLCMRAH18BAK |              |              |              |
|                           |              | DLCMRAH27CAK |              |              |              |
|                           |              | DLCMRAH36DAK |              |              |              |
|                           |              | DLCMRAH48EAK |              |              |              |

\*Performance may vary based on the compatible outdoor units. See respective pages for performance data.

# Better Installation, Service & Maintenance for a Better HVAC Experience

We take pride in providing easy-to-use ductless solutions that offer simplified and flexible installation and maintenance. Now, with an improved mounting frame, a more flexible unit design and better filter access, we've made the installation, service and maintenance of our entry tier indoor units easier than ever.



## IMPROVED MOUNTING

- New hook design on the mounting frame allows for a two-inch shift to the left and right
- High Wall paper template helps with installation
- Kick-stands lift the frame to provide easier access to piping, drain connections and wiring



## ENHANCED UNIT DESIGN

- Rotatable front panel for easier installation and maintenance
- Removable chassis for quicker cleaning and replacement of the fan motor
- With only four screws to remove, significantly reduce maintenance time



## EASIER FILTER ACCESS

- Filter located on the inlet for removal from the top of the unit
- No need to forcibly open the front panel to remove, and potentially bend, the filter

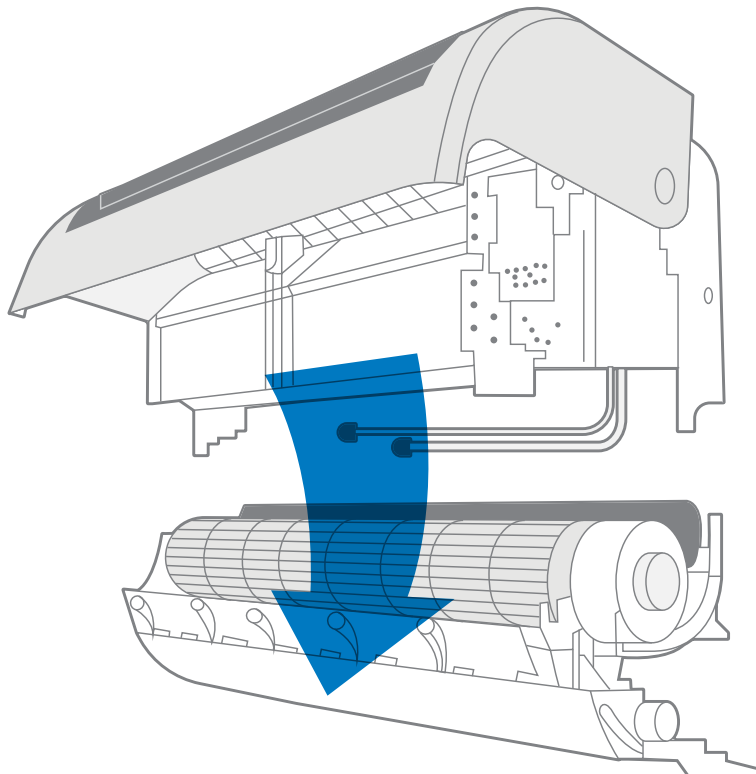
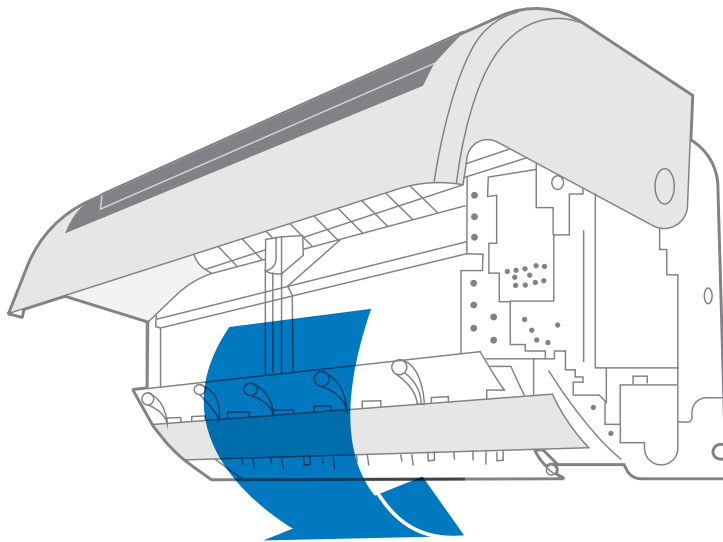
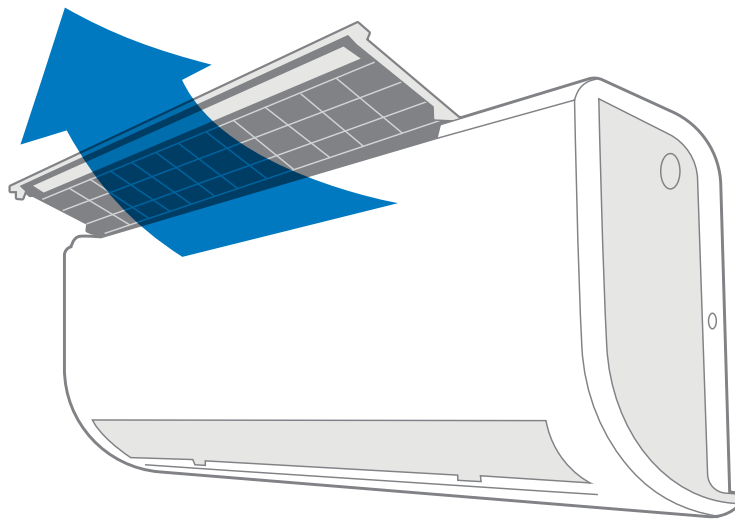

# MULTI-ZONE



**DCMRA Outdoor Unit**

Up to 21.4 SEER

Sizes: 18 / 27 / 36 / 48



# A Multi-Zone Outdoor Unit for Flexibility & Control

## OUTDOOR FEATURES

- Available in 208/230V
- Connect 2-5, multiple style indoor units
- Built-in basepan heater
- Quiet outdoor operation, as low as 62 dB(A)
- Anti-corrosive fin coating
- Total piping length 131 ~ 328 ft. (40 ~ 100 m.)
- Vertical lift/drop piping length 49 ~ 65 ft. (15 ~ 20 m.)
- Cooling operating range -13° ~ 122° F (-25° ~ 50° C)
- Heating operating range -22° ~ 86° F (-30° ~ 30° C)

## COMPATIBLE WITH:

- DLFPHA High Wall (p 17)
- DLFSHA High Wall (p 25)
- DLFEHA High Wall (p 37)
- DLFSCA Cassette (p 27)
- DLFSDA Ducted (p 29)
- DLFSFA Console (p 31)

## Heat Pump with Basepan Heater

Inverter Compressor

Up to 21.4 SEER

Up to 10.8 HSPF

Sizes: 18 / 27 / 36 / 48

Select systems are ENERGY STAR® certified based on indoor combinations



## KEY FEATURES

### Space Saving Installation

Up to five indoor units can be connected to a single outdoor unit, reducing the number of outdoor units required. All indoor units can be individually controlled and do not need to be installed at the same time.

### Multiple Indoor Unit Styles

Flexibility on the options of indoor unit styles to fit any application or need.

**Note:** Multi-zone units cannot heat and cool simultaneously.



**SPECIFICATIONS:**







| DLCMRA Outdoor Unit                           |           |                  |                  |                               |                               |
|---|-----------|------------------|------------------|-------------------------------|-------------------------------|
| Heat Pump                                     |           |                  |                  |                               |                               |
| Size  |           | 18               | 27               | 36                            | 48                            |
| Outdoor Model                                 |           | DLCMRAH18BAK     | DLCMRAH27CAK     | DLCMRAH36DAK                  | DLCMRAH48BAK                  |
| Max Number of Zones                           |           | 2                | 3                | 4                             | 5                             |
| Performance Non-Ducted                        |           |                  |                  |                               |                               |
| ENERGY STAR®                                  |           | YES              | NO               | NO                            | NO                            |
| Cooling System Tons                           |           | 1.4              | 2.3              | 3.0                           | 4.0                           |
| Cooling Rated Capacity                        | Btu/h     | 17,000           | 27,000           | 36,000                        | 48,000                        |
| Cooling Cap. Range Min - Max                  | Btu/h     | 5,810~21,940     | 7,880~33,510     | 8,090~41,470                  | 8,560~53,160                  |
| SEER  |           | 21.1             | 20.4             | 21.4                          | 20.5                          |
| EER   |           | 12.5             | 11.5             | 10.5                          | 11                            |
| Heating Rated Capacity (47° F)                | Btu/h     | 18,000           | 27,000           | 36,000                        | 48,000                        |
| Heating Maximum Capacity (5° F)               | Btu/h     | 13,800           | 22,700           | 26,200                        | 37,900                        |
| Heating Cap. Range Min - Max                  | Btu/h     | 5,760~24,480     | 6,010~36,180     | 6,350~41,950                  | 7,210~55,820                  |
| HSPF  |           | 9.7              | 10.8             | 10.2                          | 10.2                          |
| COP (47° F)                                   | W/W       | 3.5              | 4.0              | 3.7                           | 3.5                           |
| COP (5° F)                                    | W/W       | 2.7              | 3.4              | 2.7                           | 2.8                           |
| Performance Combination Ducted and Non-Ducted |           |                  |                  |                               |                               |
| ENERGY STAR®                                  |           | NO               | NO               | NO                            | NO                            |
| Cooling System Tons                           |           | 1.5              | 2.3              | 3.0                           | 4.0                           |
| Cooling Rated Capacity                        | Btu/h     | 17,500           | 27,000           | 36,000                        | 48,000                        |
| Cooling Cap. Range Min - Max                  | Btu/h     | 5,795~20,708     | 7,765~31,955     | 8,060~39,990                  | 8,510~52,580                  |
| SEER  |           | 19.8             | 19.5             | 19.7                          | 19.1                          |
| EER   |           | 12.2             | 11.3             | 10.3                          | 10.6                          |
| Heating Rated Capacity (47° F)                | Btu/h     | 18,250           | 27,000           | 36,000                        | 49,000                        |
| Heating Maximum Capacity (5° F)               | Btu/h     | 14,100           | 21,850           | 27,300                        | 37,350                        |
| Heating Cap. Range Min - Max                  | Btu/h     | 5,650~24,365     | 5,980~36,190     | 6,275~42,305                  | 7,045~54,935                  |
| HSPF  |           | 9.6              | 9.9              | 10.0                          | 10.2                          |
| COP (47° F)                                   | W/W       | 3.7              | 3.8              | 3.5                           | 3.5                           |
| COP (5° F)                                    | W/W       | 2.4              | 3.0              | 2.6                           | 2.3                           |
| Performance Ducted                            |           |                  |                  |                               |                               |
| ENERGY STAR®                                  |           | NO               | NO               | NO                            | NO                            |
| Cooling System Tons                           |           | 1.5              | 2.3              | 3.0                           | 4.0                           |
| Cooling Rated Capacity                        | Btu/h     | 18,000           | 27,000           | 36,000                        | 48,000                        |
| Cooling Cap. Range Min - Max                  | Btu/h     | 5,780~19,476     | 7,650~30,400     | 8,030~38,510                  | 8,460~52,000                  |
| SEER  |           | 18.4             | 18.5             | 17.9                          | 17.6                          |
| EER   |           | 11.8             | 11.0             | 10.0                          | 10.1                          |
| Heating Rated Capacity (47° F)                | Btu/h     | 18,500           | 27,000           | 36,000                        | 50,000                        |
| Heating Maximum Capacity (5° F)               | Btu/h     | 14,400           | 21,000           | 28,400                        | 36,800                        |
| Heating Cap. Range Min - Max                  | Btu/h     | 5,539~24,249     | 5,950~36,200     | 6,200~42,660                  | 6,880~54,050                  |
| HSPF  |           | 9.4              | 9.0              | 9.7                           | 10.1                          |
| COP (47° F)                                   | W/W       | 3.8              | 3.5              | 3.2                           | 3.4                           |
| COP (5° F)                                    | W/W       | 2.1              | 2.7              | 2.5                           | 1.8                           |
| Operating Range                               |           |                  |                  |                               |                               |
| Cooling Outdoor DB Min - Max                  | ° F (° C) | -13~122 (-25~50) | -13~122 (-25~50) | -13~122 (-25~50)              | -13~122 (-25~50)              |
| Heating Outdoor DB Min - Max                  | ° F (° C) | -22~86 (-30~30)  | -22~86 (-30~30)  | -22~86 (-30~30)               | -22~86 (-30~30)               |
| Piping  |           |                  |                  |                               |                               |
| Total Piping Length                           | ft (m)    | 131 (40)         | 197 (60)         | 263 (80)                      | 328 (100)                     |
| Piping to furthest FCU                        | ft (m)    | 82 (25)          | 98 (30)          | 115 (35)                      | 115 (35)                      |
| Drop (OD above ID)                            | ft (m)    | 49 (15)          | 49 (15)          | 49 (15)                       | 65 (20)                       |
| Lift (OD below ID)                            | ft (m)    | 49 (15)          | 49 (15)          | 49 (15)                       | 65 (20)                       |
| Pipe Connection Size - Liquid                 | in (mm)   | 1/4*2 (6.35*2)   | 1/4*3 (6.35*3)   | 1/4*4 (6.35*4)                | 1/4*5 (6.35*5)                |
| Pipe Connection Size - Suction                | in (mm)   | 3/8*2 (9.52*2)   | 3/8*3 (9.52*3)   | 1/2 *1+ 3/8*3 (12.7*1+9.52*3) | 1/2 *2+ 3/8*3 (12.7*2+9.52*3) |

## DLCMRA OUTDOOR UNIT

### SPECIFICATIONS:

| DLCMRA Outdoor Unit |          |                                       |              |              |               |
|---------------------|----------|---------------------------------------|--------------|--------------|---------------|
| Heat Pump           |          |                                       |              |              |               |
| Outdoor Model       |          | DLCMRAH18BAK                          | DLCMRAH27CAK | DLCMRAH36DAK | DLCMRAH48EAK  |
| Refrigerant         |          |                                       |              |              |               |
| Type                |          | R410A                                 | R410A        | R410A        | R410A         |
| Charge              | lbs (kg) | 4.41 (2.0)                            | 6.17 (2.8)   | 6.61 (3.0)   | 10.13 (4.6)   |
| Electrical          |          |                                       |              |              |               |
| Voltage-Phase-Cycle | V-Ph-Hz  | 208/230-1-60                          | 208/230-1-60 | 208/230-1-60 | 208/230-1-60  |
| Power Supply        |          | Indoor unit powered from outdoor unit |              |              |               |
| MCA                 | A.       | 18                                    | 25           | 30           | 35            |
| MOCP - Fuse Rating  | A.       | 25                                    | 35           | 45           | 50            |
| Outdoor             |          |                                       |              |              |               |
| Unit Width          | in (mm)  | 37.31 (948)                           | 41.22 (1047) | 41.22 (1047) | 41.15 (1045)  |
| Unit Height         | in (mm)  | 27.64 (702)                           | 31.88 (810)  | 31.88 (810)  | 52.48 (1333)  |
| Unit Depth          | in (mm)  | 14.82 (376)                           | 17.91 (455)  | 17.91 (455)  | 17.63 (448)   |
| Net Weight          | lbs (kg) | 105.8 (48)                            | 149.9 (68)   | 156.5 (71)   | 223.8 (101.5) |
| Airflow             | CFM      | 1,390                                 | 2,130        | 2,130        | 4,500         |
| Sound Pressure      | dB(A)    | 62                                    | 63           | 62           | 64            |

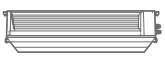
### COMPATIBILITY:

|                  | Indoor Unit | Outdoor Unit |              |              |              |   |
|------------------|-------------|--------------|--------------|--------------|--------------|---|
|                  |             | DLCMRAH18BAK | DLCMRAH27CAK | DLCMRAH36DAK | DLCMRAH48EAK |   |
| DLFPHA High Wall | DLFPHA09XAK | •            | •            | •            | •            |  |
|                  | DLFPHA12XAK | •            | •            | •            | •            |   |
|                  | DLFPHA18XAK |              |              |              |              |   |
|                  | DLFPHA24XAK |              |              |              |              |   |
| DLFSHA High Wall | DLFSHA09XAK | •            | •            | •            | •            |  |
|                  | DLFSHA12XAK | •            | •            | •            | •            |   |
|                  | DLFSHA18XAK |              | •            | •            | •            |   |
|                  | DLFSHA24XAK |              |              | •            | •            |   |
| DLFEHA High Wall | DLFEHA09XAK | •            | •            | •            | •            |  |
|                  | DLFEHA12XAK | •            | •            | •            | •            |   |
|                  | DLFEHA18XAK |              | •            | •            | •            |   |
|                  | DLFEHA24XAK |              |              | •            | •            |   |
| DLFSCA Cassette  | DLFSCA09XAK | •            | •            | •            | •            |  |
|                  | DLFSCA12XAK | •            | •            | •            | •            |   |
|                  | DLFSCA18XAK |              | •            | •            | •            |   |
|                  | DLFSCA24XAK |              |              | •            | •            |   |
| DLFSDA Ducted    | DLFSDA09XAK | •            | •            | •            | •            |  |
|                  | DLFSDA12XAK | •            | •            | •            | •            |   |
|                  | DLFSDA18XAK |              | •            | •            | •            |   |
|                  | DLFSDA24XAK |              |              | •            | •            |   |
| DLFSFA Console   | DLFSFA12XAK | •            | •            | •            | •            |  |
|                  | DLFSFA18XAK |              | •            | •            | •            |   |
|                  | DLFSFA24XAK |              |              | •            | •            |   |

Manufacturer reserves the right to discontinue, or change at any time, specification or designs without notice or incurring obligations.





**COMBINATION CHART:**

| DLCMRA Outdoor Unit |          |             |             |                |
|---------------------|----------|-------------|-------------|----------------|
| Outdoor Model       | 2-Zone   | 3-Zone      | 4-Zone      | 5-Zone         |
| DLCMRAH18BAK        | 9+9      |             |             |                |
|                     | 9+12     |             |             |                |
|                     | 12+12    |             |             |                |
| DLCMRAH27CAK        | 9+9      | 9+9+9       |             |                |
|                     | 9+12     | 9+9+12      |             |                |
|                     | 9+18     | 9+9+18      |             |                |
|                     | 12+12    | 9+12+12     |             |                |
|                     | 12+18    | 12+12+12    |             |                |
|                     | 18+18    |             |             |                |
| DLCMRAH36DAK        | 9+9      | 9+9+9       | 9+9+9+9     |                |
|                     | 9+12     | 9+9+12      | 9+9+9+12    |                |
|                     | 9+18     | 9+9+18      | 9+9+9+18    |                |
|                     | 9+24     | 9+9+24      | 9+9+12+12   |                |
|                     | 12+12    | 9+12+12     | 9+9+12+18   |                |
|                     | 12+18    | 9+12+18     | 9+12+12+12  |                |
|                     |          | 9+12+24     |             |                |
|                     | 12+24    | 9+18+18     | 12+12+12+12 |                |
|                     | 18+18    | 12+12+12    |             |                |
|                     |          | 12+12+18    |             |                |
|                     | 12+18+18 |             |             |                |
|                     | 12+12+24 |             |             |                |
| DLCMRAH48EAK        | 9+18     | 9+9+9       | 9+9+9+9     | 9+9+9+9+9      |
|                     | 9+24     | 9+9+12      | 9+9+9+12    | 9+9+9+9+12     |
|                     | 12+12    | 9+9+18      | 9+9+9+18    | 9+9+9+9+18     |
|                     | 12+18    | 9+9+24      | 9+9+9+24    | 9+9+9+9+24     |
|                     | 12+24    | 9+12+12     | 9+9+12+12   | 9+9+9+12+12    |
|                     | 18+18    | 9+12+18     | 9+9+12+18   | 9+9+9+12+18    |
|                     | 18+24    | 9+12+24     | 9+9+12+24   | 9+9+9+18+18    |
|                     | 24+24    | 9+18+18     | 9+9+18+18   | 9+9+12+12+12   |
|                     |          | 9+18+24     | 9+9+18+24   | 9+9+12+12+18   |
|                     |          | 9+24+24     | 9+12+12+12  | 9+12+12+12+12  |
|                     |          | 12+12+12    | 9+12+12+18  | 9+12+12+12+18  |
|                     |          | 12+12+18    | 9+12+12+24  | 12+12+12+12+12 |
|                     |          | 12+12+24    | 9+12+18+18  |                |
|                     |          | 12+18+18    | 9+18+18+18  |                |
|                     |          | 12+18+24    | 12+12+12+12 |                |
|                     |          | 12+24+24    | 12+12+12+18 |                |
|                     | 18+18+18 | 12+12+12+24 |             |                |
|                     | 18+18+24 | 12+12+18+18 |             |                |

Up to five indoor units can be connected to a single outdoor unit, reducing the number of outdoor units required.

# SINGLE ZONE LIGHT COMMERCIAL

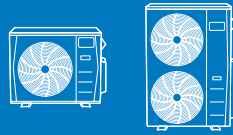

**DLCLRA Outdoor Unit**

Up to 18.0 SEER  
Sizes: 36 / 48 / 58



**DLFLCA Cassette**

Sizes: 36 / 48



**DLFLDA Ducted**

Sizes: 36 / 48 / 58



**DLFLFA Console**

Sizes: 36 / 48 / 58

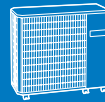

**NH4A4 & NH4H4  
Outdoor Units**

Sizes: 18 / 24 / 30 / 36 / 48 / 60

# A Light Commercial Outdoor Unit for Improved Performance



## OUTDOOR FEATURES

- Available in 208/230V
- Built-in basepan heater
- Condenser high-temperature protection
- Refrigerant leakage detection
- Quiet outdoor operation, as low as 62.5 dB(A)
- Anti-corrosive fin coating
- Piping length 213 ft. (65 m.)
- Cooling operating range -13° ~ 122° F (-25° ~ 50° C)
- Heating operating range -22° ~ 86° F (-30° ~ 30° C)

## COMPATIBLE WITH:

- DLFLCA Cassette (p 55)
- DLFLDA Ducted (p 57)
- DLFLFA Console (p 59)

## Heat Pump with Basepan Heater

Inverter Compressor

Up to 18.0 SEER

Up to 11.5 HSPF

Sizes: 36 / 48 / 58

## KEY FEATURES

### Longer Piping Lengths

Piping flexibility up to a total piping length of 213 ft. (65 m.).

### Low Ambient Cooling Kit

With a built-in Low Ambient Cooling Kit or specially designed PCB, outdoor fan speeds can be changed automatically based on the temperature. The unit can run cooling operation even in low ambient temperatures.

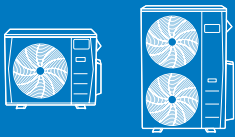

**PERFORMANCE:**

| <b>DLFLCA Cassette</b>          |       |              |               |
|---------------------------------|-------|--------------|---------------|
| Indoor Model                    |       | DLFLCAH36XAK | DLFLCAH48XAK  |
| <b>ENERGY STAR®</b>             |       | NO           | NO            |
| Cooling System Tons             |       | 3.0          | 4.0           |
| Cooling Rated Capacity          | Btu/h | 36,000       | 48,000        |
| Cooling Cap. Range Min - Max    | Btu/h | 8,500~38,000 | 9,000~50,000  |
| SEER                            |       | 17.5         | 16.8          |
| EER                             |       | 9.0          | 9.5           |
| Heating Rated Capacity (47° F)  | Btu/h | 38,000       | 50,000        |
| Heating Rated Capacity (17° F)  | Btu/h | 25,200       | 35,000        |
| Heating Maximum Capacity (5° F) | Btu/h | 25,300       | 34,000        |
| Heating Cap. Range Min - Max    | Btu/h | 9,500~50,000 | 10,000~55,000 |
| HSPF                            |       | 10.5         | 11.0          |
| COP (47° F)                     | W/W   | 3            | 3.6           |
| COP (17° F)                     | W/W   | 2.46         | 2.62          |
| COP (5° F)                      | W/W   | 1.71         | 1.84          |

**PERFORMANCE:**

| <b>DLFLDA Ducted</b>            |       |              |               |               |
|---------------------------------|-------|--------------|---------------|---------------|
| Indoor Model                    |       | DLFLDAH36XAK | DLFLDAH48XAK  | DLFLDAH58XAK  |
| <b>ENERGY STAR®</b>             |       | NO           | NO            | NO            |
| Cooling System Tons             |       | 3.0          | 4.0           | 4.8           |
| Cooling Rated Capacity          | Btu/h | 36,000       | 48,000        | 57,000        |
| Cooling Cap. Range Min - Max    | Btu/h | 8,500~38,000 | 9,000~50,000  | 18,000~58,000 |
| SEER                            |       | 16.5         | 17.4          | 18.0          |
| EER                             |       | 9            | 9.2           | 10.0          |
| Heating Rated Capacity (47° F)  | Btu/h | 40,000       | 49,500        | 62,000        |
| Heating Rated Capacity (17° F)  | Btu/h | 27,600       | 33,400        | 37,600        |
| Heating Maximum Capacity (5° F) | Btu/h | 25,300       | 34,000        | 35,000        |
| Heating Cap. Range Min - Max    | Btu/h | 9,500~50,000 | 10,000~55,000 | 12,000~63,000 |
| HSPF                            |       | 11.5         | 10.3          | 9.0           |
| COP (47° F)                     | W/W   | 3            | 3.6           | 3.6           |
| COP (17° F)                     | W/W   | 2.46         | 2.62          | 2.62          |
| COP (5° F)                      | W/W   | 1.71         | 1.84          | 1.91          |

### PERFORMANCE:

|                                |       | DLFLFA Console |               |               |
|--------------------------------|-------|----------------|---------------|---------------|
| Indoor Model                   |       | DLFLFAH36XAK   | DLFLFAH48XAK  | DLFLFAH58XAK  |
| ENERGY STAR®                   |       | NO             | NO            | NO            |
| Cooling System Tons            |       | 3.0            | 4.0           | 4.5           |
| Cooling Rated Capacity         | Btu/h | 36,000         | 48,000        | 54,000        |
| Cooling Cap. Range Min - Max   | Btu/h | 8,500~38,000   | 9,000~50,000  | 18,000-58,000 |
| SEER                           |       | 16.0           | 17.8          | 18.0          |
| EER                            |       | 8.0            | 9.3           | 9.8           |
| Heating Rated Capacity (47° F) | Btu/h | 38,000         | 50,000        | 60,000        |
| Heating Rated Capacity (17° F) | Btu/h | 25,400         | 35,000        | 39,000        |
| Heating Capacity (5° F)        | Btu/h | 25,300         | 34,000        | 35,000        |
| Heating Cap. Range Min - Max   | Btu/h | 9,500~50,000   | 10,000~55,000 | 12,000-63,000 |
| HSPF                           |       | 10.0           | 11.0          | 10.5          |
| COP (47° F)                    | W/W   | 3              | 3.6           | 3.6           |
| COP (17° F)                    | W/W   | 2.46           | 2.62          | 2.62          |
| COP (5° F)                     | W/W   | 1.71           | 1.84          | 1.91          |

### COMPATIBILITY:

| Indoor Unit     |              | Outdoor Unit |              |              |
|-----------------|--------------|--------------|--------------|--------------|
|                 |              | DLCLRAH36AAK | DLCLRAH48AAK | DLCLRAH58AAK |
| DLFLCA Cassette | DLFLCAH36XAK | •            |              |              |
|                 | DLFLCAH48XAK |              | •            |              |
| DLFLDA Ducted   | DLFLDAH36XAK | •            |              |              |
|                 | DLFLDAH48XAK |              | •            |              |
|                 | DLFLDAH58XAK |              |              | •            |
| DLFLFA Console  | DLFLFAH36XAK | •            |              |              |
|                 | DLFLFAH48XAK |              | •            |              |
|                 | DLFLFAH58XAK |              |              | •            |

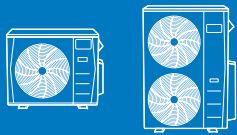

**SPECIFICATIONS:**

| <b>DLCLRA Outdoor Unit</b>     |           |                  |                  |                  |
|--------------------------------|-----------|------------------|------------------|------------------|
| <b>Heat Pump</b>               |           |                  |                  |                  |
| <b>System</b>                  |           |                  |                  |                  |
| Size                           |           | 36               | 48               | 58               |
| Outdoor Model                  |           | DLCLRAH36AAK     | DLCLRAH48AAK     | DLCLRAH58AAK     |
| <b>Electrical</b>              |           |                  |                  |                  |
| Voltage-Phase-Cycle            | V-Ph-Hz   | 208/230-1-60     | 208/230-1-60     | 208/230-1-60     |
| MCA                            | A.        | 30               | 35               | 35               |
| MOCP - Fuse Rating             | A.        | 50               | 50               | 50               |
| <b>Operating Range</b>         |           |                  |                  |                  |
| Cooling Outdoor DB Min - Max   | ° F (° C) | -13~122 (-25~50) | -13~122 (-25~50) | -13~122 (-25~50) |
| Heating Outdoor DB Min - Max   | ° F (° C) | -22~86 (-30~30)  | -22~86 (-30~30)  | -22~86 (-30~30)  |
| <b>Piping</b>                  |           |                  |                  |                  |
| Total Piping Length            | ft (m)    | 213 (65)         | 213 (65)         | 213 (65)         |
| Piping Lift*                   | ft (m)    | 98 (30)          | 98 (30)          | 98 (30)          |
| Pipe Connection Size - Liquid  | in (mm)   | 3/8 (9.52)       | 3/8 (9.52)       | 3/8 (9.52)       |
| Pipe Connection Size - Suction | in (mm)   | 5/8 (16)         | 5/8 (16)         | 3/4 (19)         |
| <b>Refrigerant</b>             |           |                  |                  |                  |
| Type                           |           | R410A            | R410A            | R410A            |
| Charge                         | lbs (kg)  | 6.72 (3.05)      | 9.26 (4.2)       | 10.19 (4.62)     |
| <b>Outdoor</b>                 |           |                  |                  |                  |
| Unit Width                     | in (mm)   | 37.24 (946)      | 37.48 (952)      | 37.48 (952)      |
| Unit Height                    | in (mm)   | 31.89 (810)      | 52.48 (1333)     | 52.48 (1333)     |
| Unit Depth                     | in (mm)   | 16.14 (410)      | 16.34 (415)      | 16.34 (415)      |
| Net Weight                     | lbs (kg)  | 148.59 (67.4)    | 217.4 (98.6)     | 225.09 (102.1)   |
| Airflow                        | CFM       | 2,130            | 4,500            | 4,415            |
| Sound Pressure                 | dB(A)     | 63.0             | 62.5             | 64.0             |

\*Condensing unit above or below indoor unit.



# Optimal Air Distribution & Light Commercial Comfort Control

## INDOOR FEATURES

- Available in 208/230V
- Up to 17.5 SEER and 11.0 HSPF when paired with DLCLRA outdoor unit
- Modes: Cool, Heat, Dry, Fan, Auto
- Auto-restart function
- Louver control (fixed or swing)
- Three fan speeds
- Outside air intake
- Built-in condensate lift pump
- Follow Me (senses temperature at handheld remote)
- Heating Setback (46° F Heating Mode)
- Quiet indoor operation, as low as 49 dB(A)
- Anti-corrosive fin coating
- Grille/ceiling panel 3' x 3' KSALG0201AAA

## COMPATIBLE WITH:

- DLCLRA Outdoor Unit Single Zone

(p 51)

Sizes: 36 / 48

## KEY FEATURES

### Built-In Condensate Lift Pump

The Cassette is supplied with a condensate lift pump that is capable of lifting the water 29.5 in. (750 mm.) above the top of the unit.

### 360° Air Flow Panel

With the 360° air flow panel, air is distributed to every corner of the room.

## CONTROLS

Wireless Remote Controller included with indoor unit

Optional Wired Remote Controller KSACN0101AAA (Timer Function)

Optional Wired Remote Controller KSACN0501AAA (7-Day Programmable)



Wireless Remote Controller



Wired Controller (7-Day Programmable) KSACN0501AAA

## ACCESSORIES

Wi-Fi® Kit KSAIF0401AAA



24V Interface for third-party thermostat compatibility KSAIC0401230

**NOTE:** Grille is required; sold separately.



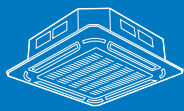

**SPECIFICATIONS:**

| <b>DLFLCA Cassette</b>             |              |                                       |               |
|------------------------------------|--------------|---------------------------------------|---------------|
| <b>Heat Pump</b>                   |              |                                       |               |
| <b>System</b>                      |              |                                       |               |
| Size                               |              | 36                                    | 48            |
| Indoor Model                       |              | DLFLCAH36XAK                          | DLFLCAH48XAK  |
| <b>Electrical</b>                  |              |                                       |               |
| Voltage-Phase-Cycle                | V-Ph-Hz      | 208/230-1-60                          | 208/230-1-60  |
| Power Supply                       |              | Indoor unit powered from outdoor unit |               |
| MCA                                | A.           | 0.8                                   | 1.6           |
| <b>Operating Range</b>             |              |                                       |               |
| Cooling Indoor DB Min - Max        | ° F (° C)    | 63~90 (17~32)                         | 63~90 (17~32) |
| Heating Indoor DB Min - Max        | ° F (° C)    | 32~86 (0~30)                          | 32~86 (0~30)  |
| <b>Piping</b>                      |              |                                       |               |
| Pipe Connection Size - Liquid      | in (mm)      | 3/8 (9.52)                            | 3/8 (9.52)    |
| Pipe Connection Size - Suction     | in (mm)      | 5/8 (16)                              | 5/8 (16)      |
| <b>Indoor</b>                      |              |                                       |               |
| Body Unit Width                    | in (mm)      | 33.07 (840)                           | 33.07 (840)   |
| Body Unit Height                   | in (mm)      | 9.65 (245)                            | 11.3 (287)    |
| Body Unit Depth                    | in (mm)      | 33.07 (840)                           | 33.07 (840)   |
| Body Net Weight                    | lbs (kg)     | 58.2 (26.4)                           | 63.27 (28.7)  |
| Panel Unit Width                   |              | 37.4 (950)                            | 37.4 (950)    |
| Panel Unit Height                  | in (mm)      | 2.17 (55)                             | 2.17 (55)     |
| Panel Unit Depth                   | in (mm)      | 37.4 (950)                            | 37.4 (950)    |
| Panel Net Weight                   | lbs (kg)     | 11.02 (5)                             | 11.02 (5)     |
| Number of Fan Speeds               |              | 3                                     | 3             |
| Airflow (lowest to highest)        | CFM          | 809/958/1095                          | 853/1030/1177 |
| Sound Pressure (lowest to highest) | dB(A)        | 49/52/55                              | 49/52/55      |
| Air Throw Data                     | ft (m)       | 30 (9)                                | 30 (9)        |
| Moisture Removal                   | Pint/h (L/h) | 8.53 (4.04)                           | 13.5 (6.39)   |
| Field Drain Pipe Size O.D.         | in (mm)      | 1 (25.4)                              | 1 (25.4)      |

**COMPATIBILITY:**

|                           |              |              |
|---------------------------|--------------|--------------|
| Indoor Unit               | DLFLCAH36XAK | DLFLCAH48XAK |
| Outdoor Unit Single Zone* | DLCLRAH36AAK | DLCLRAH48AAK |

\*Performance may vary based on the compatible outdoor units. See respective pages for performance data.



# Maximum Flexibility & Light Commercial Performance

## INDOOR FEATURES

- Available in 208/230V
- Up to 18.0 SEER and 11.5 HSPF when paired with DLCLRA outdoor unit
- Modes: Cool, Heat, Dry, Fan, Auto
- Vertical (sizes 36 & 48) or horizontal installation
- Up to 0.8 in WG
- Rear or bottom return (sizes 36 & 48)
- Constant CFM operation on sizes 36 & 48 only
- Built-in condensate lift pump
- Follow Me (senses temperature at handheld remote)
- Heating Setback (46° F Heating Mode)
- Quiet indoor operation, as low as 38.5 dB(A)
- Anti-corrosive fin coating

## COMPATIBLE WITH:

- DLCLRA Outdoor Unit Single Zone

(p 51)

Sizes: 36 / 48 / 58

## KEY FEATURES

### Vertical or Horizontal Installation

Designed for maximum installation flexibility with the built-in secondary drain pan, which allows the unit to be mounted vertically for either a floor- or ceiling-concealed installation depending on existing conditions for sizes 36 and 48 only.

### Built-In Condensate Lift Pump

Supplied with a condensate lift pump that is capable of lifting the water 29.5 in. (750 mm.) above the top of the unit.

## CONTROLS

Wireless Remote Controller included with indoor unit

Wired Remote Controller (7-Day Programmable) included with indoor unit



**Wireless Remote Controller**



**Wired Controller (7-Day Programmable) KSACN0501AAA**

## ACCESSORIES

Wi-Fi® Kit KSAIF0401AAA

24V Interface for third-party thermostat compatibility KSAIC0401230





**SPECIFICATIONS:**

| <b>DLFLDA Ducted</b>               |                                       |               |               |                |
|------------------------------------|---------------------------------------|---------------|---------------|----------------|
| <b>Heat Pump</b>                   |                                       |               |               |                |
| <b>System</b>                      |                                       |               |               |                |
| Size                               |                                       | 36            | 48            | 58             |
| Indoor Model                       |                                       | DLFLDAH36XAK  | DLFLDAH48XAK  | DLFLDAH58XAK   |
| <b>Electrical</b>                  |                                       |               |               |                |
| Voltage-Phase-Cycle                | V-Ph-Hz                               | 208/230-1-60  | 208/230-1-60  | 208/230-1-60   |
| Power Supply                       | Indoor unit powered from outdoor unit |               |               |                |
| MCA                                | A.                                    | 2.45          | 3.2           | 3.65           |
| <b>Operating Range</b>             |                                       |               |               |                |
| Cooling Indoor DB Min - Max        | ° F (° C)                             | 63~90 (17~32) | 63~90 (17~32) | 63~90 (17~32)  |
| Heating Indoor DB Min - Max        | ° F (° C)                             | 32~86 (0~30)  | 32~86 (0~30)  | 32~86 (0~30)   |
| <b>Piping</b>                      |                                       |               |               |                |
| Pipe Connection Size - Liquid      | in (mm)                               | 3/8 (9.52)    | 3/8 (9.52)    | 3/8 (9.52)     |
| Pipe Connection Size - Suction     | in (mm)                               | 5/8 (16)      | 5/8 (16)      | 3/4 (19)       |
| <b>Indoor</b>                      |                                       |               |               |                |
| Unit Width                         | in (mm)                               | 53.54 (1360)  | 47.24 (1200)  | 55.12 (1400)   |
| Unit Height                        | in (mm)                               | 9.8 (249)     | 11.81 (300)   | 17.32 (440)    |
| Unit Depth                         | in (mm)                               | 30.47 (774)   | 34.41 (874)   | 33.78 (858)    |
| Net Weight                         | lbs (kg)                              | 106.48 (48.3) | 119.71 (54.3) | 163 (74)       |
| Number of Fan Speeds               |                                       | 3             | 3             | 3              |
| Airflow (lowest to highest)        | CFM                                   | 700/910/1080  | 720/1030/1230 | 1260/1710/2150 |
| Sound Pressure (lowest to highest) | dB(A)                                 | 38.5/42/45.5  | 46/49.5/50.5  | 51/54/57       |
| Max. Static Pressure               | in (WG)                               | 0.64          | 0.64          | 0.80           |
| Field Drain Pipe Size O.D.         | in (mm)                               | 1 (25.4)      | 1 (25.4)      | 1 (25.4)       |

**COMPATIBILITY:**

|                           |              |              |              |
|---------------------------|--------------|--------------|--------------|
| Indoor Unit               | DLFLDAH36XAK | DLFLDAH48XAK | DLFLDAH58XAK |
| Outdoor Unit Single Zone* | DLCLRAH36AAK | DLCLRAH48AAK | DLCLRAH58AAK |

\*Performance may vary based on the compatible outdoor units. See respective pages for performance data.



# Easy Light Commercial Installation & Quiet Operation

## INDOOR FEATURES

- Available in 208/230V
- Up to 18.0 SEER and 11.0 HSPF when paired with DLCLRA outdoor unit
- Modes: Cool, Heat, Dry, Fan, Auto
- Auto-restart function
- Can be mounted on floor or ceiling
- Louver control (fixed or swing)
- Three fan speeds
- Follow Me (senses temperature at handheld remote)
- Heating Setback (46° F Heating Mode)
- Quiet indoor operation, as low as 43 dB(A)
- Anti-corrosive fin coating

## COMPATIBLE WITH:

- DLCLRA Outdoor Unit Single Zone

(p 51)

Sizes: 36 / 48 / 58

## KEY FEATURES

### Outside Air Intake

Outside air can be brought into the room through the connection available on the indoor unit, which helps meet the ventilation air requirements.

### Flexible Installation

Can be installed on the floor or ceiling depending on the application.

## CONTROLS

Wireless Remote Controller included with indoor unit

Optional Wired Remote Controller KSACN0101AAA (Timer Function)

Optional Wired Remote Controller KSACN0501AAA (7-Day Programmable)



Wireless Remote Controller



Wired Controller (7-Day Programmable) KSACN0501AAA

## ACCESSORIES

Wi-Fi® Kit KSAIF0401AAA



24V Interface for third-party thermostat compatibility KSAIC0401230



**SPECIFICATIONS:**

| <b>DLFLFA Console</b>              |           |                                       |                |               |
|------------------------------------|-----------|---------------------------------------|----------------|---------------|
| <b>Heat Pump</b>                   |           |                                       |                |               |
| <b>System</b>                      |           |                                       |                |               |
| Size                               |           | 36                                    | 48             | 58            |
| Indoor Model                       |           | DLFLFAH36XAK                          | DLFLFAH48XAK   | DLFLFAH58XAK  |
| <b>Electrical</b>                  |           |                                       |                |               |
| Voltage-Phase-Cycle                | V-Ph-Hz   | 208/230-1-60                          | 208/230-1-60   | 208/230-1-60  |
| Power Supply                       |           | Indoor unit powered from outdoor unit |                |               |
| MCA                                | A.        | 1.23                                  | 0.85           | 1.48          |
| <b>Operating Range</b>             |           |                                       |                |               |
| Cooling Indoor DB Min - Max        | ° F (° C) | 63~90 (17~32)                         | 63~90 (17~32)  | 63~90 (17~32) |
| Heating Indoor DB Min - Max        | ° F (° C) | 32~86 (0~30)                          | 32~86 (0~30)   | 32~86 (0~30)  |
| <b>Piping</b>                      |           |                                       |                |               |
| Pipe Connection Size - Liquid      | in (mm)   | 3/8 (9.52)                            | 3/8 (9.52)     | 3/8 (9.52)    |
| Pipe Connection Size - Suction     | in (mm)   | 5/8 (16)                              | 5/8 (16)       | 5/8 (16)      |
| <b>Indoor</b>                      |           |                                       |                |               |
| Unit Width                         | in (mm)   | 50.59 (1285)                          | 64.96 (1650)   | 64.96 (1650)  |
| Unit Height                        | in (mm)   | 9.25 (235)                            | 9.25 (235)     | 9.25 (235)    |
| Unit Depth                         | in (mm)   | 26.57 (675)                           | 26.57 (675)    | 26.57 (675)   |
| Net Weight                         | lbs (kg)  | 69 (31.3)                             | 83.78 (38)     | 110 (50)      |
| Number of Fan Speeds               |           | 3                                     | 3              | 3             |
| Airflow (lowest to highest)        | CFM       | 638/917/1037                          | 1000/1120/1350 | 796/1029/1385 |
| Sound Pressure (lowest to highest) | dB(A)     | 43/49/54                              | 52/54/57       | 46/49/55      |
| Air Throw Data                     | ft (m)    | 33(10)                                | 39(12)         | 39(12)        |
| Field Drain Pipe Size O.D.         | in (mm)   | 1 (25.4)                              | 1 (25.4)       | 1 (25.4)      |

**COMPATIBILITY:**

|                           |              |              |              |
|---------------------------|--------------|--------------|--------------|
| Indoor Unit               | DLFLFAH36XAK | DLFLFAH48XAK | DLFLFAH58XAK |
| Outdoor Unit Single Zone* | DLCLRAH36AAK | DLCLRAH48AAK | DLCLRAH58AAK |

\*Performance may vary based on the compatible outdoor units. See respective pages for performance data.

NH4A4 & NH4H4  
OUTDOOR UNITS



### INDOOR FEATURES

- Available in 208/230V-1, 208/230V-3 and 460V-3
- All-steel cabinet construction
- Mesh coil guard
- Quiet outdoor operation, as low as 66 dB(A)
- Piping length up to 250 ft. (76.2 m.)
- Small footprint
- Single-stage compressor operation
- Narrow cabinet design
- Cooling operating range -20° ~ 125° F (-28° ~ 52° C) (w/ Low Ambient Kit)
- Heating operating range 17° ~ 75° F (-8° ~ 24° C)

### COMPATIBLE WITH:

- Fan Coils
- A-Coils

# A Versatile Outdoor Unit with a Small Footprint That's Built to Last

Fixed Speed Compressor

14.0 SEER

8.2 HSPF

Sizes: 18 / 24 / 30 / 36 / 48 / 60

### KEY FEATURES

#### Longer Total Equivalent Piping Length

Piping flexibility for a total equivalent piping length up to 250 ft. (76 m.).

#### Low Ambient Cooling with Low Ambient Kit

With the Low Ambient Kit, the outdoor fan speeds can be changed automatically based on the temperature so the unit can run cooling operation down to -20° F (-28° C).

### ACCESSORIES

Wind Baffle NASA00201WB, NASA00301WB,  
NASA00401WB

Low Ambient Kit NASA401LA

Wall Mounting Kit NASA00101WM, NASA00201WM

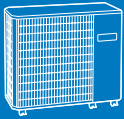

**PERFORMANCE:**

| NH4A4 & NH4H4 Outdoor Units          |                                  |       |        |        |        |        |        |        |
|--------------------------------------|----------------------------------|-------|--------|--------|--------|--------|--------|--------|
| Cooling Only                         |                                  |       |        |        |        |        |        |        |
| Nominal Performance Ducted Fan Coils | Indoor Model                     |       | *      | *      | *      | *      | *      |        |
|                                      | ENERGY STAR®                     |       | NO     | NO     | NO     | NO     | NO     |        |
|                                      | Cooling System Tons              |       | 1.5    | 2.0    | 2.5    | 3.0    | 3.0    | 3.0    |
|                                      | Cooling Rated Capacity (Nominal) | Btu/h | 18,000 | 24,000 | 29,600 | 35,400 | 35,400 | 35,400 |
|                                      | SEER                             |       | 14.0   | 14.0   | 14.0   | 14.0   | 14.0   | 14.0   |
|                                      | EER                              |       | 12.2   | 12.2   | 12.2   | 12.2   | 12.2   | 12.2   |

| NH4A4 & NH4H4 Outdoor Units          |                                  |       |        |        |        |        |        |        |
|--------------------------------------|----------------------------------|-------|--------|--------|--------|--------|--------|--------|
| Cooling Only                         |                                  |       |        |        |        |        |        |        |
| Nominal Performance Ducted Fan Coils | Indoor Model                     |       | *      | *      | *      | *      | *      |        |
|                                      | ENERGY STAR®                     |       | NO     | NO     | NO     | NO     | NO     |        |
|                                      | Cooling System Tons              |       | 3.8    | 3.8    | 3.8    | 4.8    | 4.8    | 4.8    |
|                                      | Cooling Rated Capacity (Nominal) | Btu/h | 45,000 | 45,000 | 45,000 | 57,000 | 57,000 | 57,000 |
|                                      | SEER                             |       | 14.0   | 14.0   | 14.0   | 14.0   | 14.0   | 14.0   |
|                                      | EER                              |       | 11.7   | 11.7   | 11.7   | 11.7   | 11.7   | 11.7   |

\*TESTED AHRI COMBINATION RATINGS  
 Additional ratings and system combinations can be accessed via the database at: [www.icpeqp.com](http://www.icpeqp.com)  
 For AHRI ratings certificates, please refer to the AHRI directory. [www.ahridirectory.org](http://www.ahridirectory.org)

**PERFORMANCE:**

| NH4A4 & NH4H4 Outdoor Units          |                        |       |        |        |        |        |        |        |
|--------------------------------------|------------------------|-------|--------|--------|--------|--------|--------|--------|
| Heat Pump                            |                        |       |        |        |        |        |        |        |
| Nominal Performance Ducted Fan Coils | Indoor Model           |       | *      | *      | *      | *      | *      |        |
|                                      | ENERGY STAR®           |       | NO     | NO     | NO     | NO     | NO     |        |
|                                      | Cooling System Tons    |       | 1.5    | 2.0    | 2.4    | 2.9    | 2.9    | 2.9    |
|                                      | Cooling Rated Capacity | Btu/h | 18,000 | 23,400 | 28,800 | 34,200 | 34,200 | 34,200 |
|                                      | SEER                   |       | 14.0   | 14.0   | 14.0   | 14.0   | 14.0   | 14.0   |
|                                      | EER                    |       | 11.5   | 11.5   | 12.5   | 12.0   | 12.0   | 11.5   |
|                                      | Heating Rated Capacity | Btu/h | 17,200 | 22,800 | 28,200 | 34,200 | 34,200 | 34,200 |
|                                      | HSPF                   |       | 8.2    | 8.2    | 8.5    | 8.5    | 8.5    | 8.2    |
| COP                                  | W/W                    | 2.48  | 2.5    | 2.62   | 2.6    | 2.6    | 2.6    |        |

| NH4A4 & NH4H4 Outdoor Units          |                        |       |        |        |        |        |        |        |
|--------------------------------------|------------------------|-------|--------|--------|--------|--------|--------|--------|
| Heat Pump                            |                        |       |        |        |        |        |        |        |
| Nominal Performance Ducted Fan Coils | Indoor Model           |       | *      | *      | *      | *      | *      |        |
|                                      | ENERGY STAR®           |       | NO     | NO     | NO     | NO     | NO     |        |
|                                      | Cooling System Tons    |       | 3.8    | 3.8    | 3.8    | 4.6    | 4.6    | 4.6    |
|                                      | Cooling Rated Capacity | Btu/h | 45,500 | 45,500 | 45,500 | 55,000 | 55,000 | 55,000 |
|                                      | SEER                   |       | 14.0   | 14.0   | 14.0   | 14.0   | 14.0   | 14.0   |
|                                      | EER                    |       | 11.5   | 11.5   | 11.5   | 11.5   | 11.5   | 11.5   |
|                                      | Heating Rated Capacity | Btu/h | 46,000 | 46,000 | 46,000 | 55,000 | 55,000 | 55,000 |
|                                      | HSPF                   |       | 8.2    | 8.2    | 8.2    | 8.2    | 8.2    | 8.2    |
|                                      | COP                    | W/W   | 2.56   | 2.56   | 2.56   | 2.62   | 2.62   | 2.62   |

\*TESTED AHRI COMBINATION RATINGS  
 Additional ratings and system combinations can be accessed via the database at: [www.icpeqp.com](http://www.icpeqp.com)  
 For AHRI ratings certificates, please refer to the AHRI directory. [www.ahridirectory.org](http://www.ahridirectory.org)

**SPECIFICATIONS:**

| NH4A4 and NH4H4 Outdoor Unit           |         |                                     |              |              |              |              |              |
|--|---------|-------------------------------------|--------------|--------------|--------------|--------------|--------------|
| <b>Cooling Only</b>                    |         |                                     |              |              |              |              |              |
| <b>System</b>                          |         |                                     |              |              |              |              |              |
| Size                                   |         | 18                                  | 24           | 30           | 36           | 36           | 36           |
| Outdoor Model                          |         | NH4A418AKA                          | NH4A424AKA   | NH4A430AKA   | NH4A436AKA   | NH4A436AHA   | NH4A436ALA   |
| <b>Electrical</b>                      |         |                                     |              |              |              |              |              |
| Outdoor Voltage-Phase-Cycle            | V-Ph-Hz | 208/230-1-60                        | 208/230-1-60 | 208/230-1-60 | 208/230-1-60 | 208/230-1-60 | 208/230-3-60 |
| MCA (Outdoor)                          | A.      | 11.8                                | 14.1         | 18.3         | 18.8         | 12.5         | 7.6          |
| MOCP - Fuse Rating (Outdoor)           | A.      | 20                                  | 25           | 30           | 30           | 20           | 15           |
| <b>Operating Range</b>                 |         |                                     |              |              |              |              |              |
| Cooling Outdoor DB Min - Max           | ° F     | 55~125 (-20° F w / Low-Ambient Kit) |              |              |              |              |              |
| <b>Piping</b>                          |         |                                     |              |              |              |              |              |
| Total Piping Length                    | ft.     | 200'                                | 200'         | 200'         | 200'         | 200'         | 200'         |
| Drop (OD above ID)                     | ft.     | 200'                                | 200'         | 200'         | 200'         | 200'         | 200'         |
| Lift (OD below ID)                     | ft.     | 65'                                 | 65'          | 65'          | 65'          | 65'          | 65'          |
| Outdoor Pipe Connection Size - Liquid  | in.     | 3/8                                 | 3/8          | 3/8          | 3/8          | 3/8          | 3/8          |
| Outdoor Pipe Connection Size - Suction | in.     | 5/8                                 | 3/4          | 3/4          | 7/8          | 7/8          | 7/8          |
| <b>Refrigerant</b>                     |         |                                     |              |              |              |              |              |
| Type                                   |         | R-410A                              | R-410A       | R-410A       | R-410A       | R-410A       | R-410A       |
| Charge                                 | lbs.    | 6.4                                 | 6.5          | 8.6          | 8.9          | 8.9          | 8.9          |
| <b>Compressor</b>                      |         |                                     |              |              |              |              |              |
| Type                                   |         | Scroll                              | Scroll       | Scroll       | Scroll       | Scroll       | Scroll       |
| <b>Outdoor</b>                         |         |                                     |              |              |              |              |              |
| Unit Width                             | in.     | 36.9                                | 36.9         | 44.5         | 44.5         | 44.5         | 44.5         |
| Unit Height                            | in.     | 31.1                                | 31.1         | 37.1         | 37.1         | 37.1         | 37.1         |
| Unit Depth                             | in.     | 14.6                                | 14.6         | 17.1         | 17.1         | 17.1         | 17.1         |
| Net Weight                             | lbs.    | 146                                 | 148          | 183          | 184          | 184          | 184          |
| Airflow                                | CFM     | 1,285                               | 1,285        | 1,900        | 2,615        | 2,615        | 2,615        |

Manufacturer reserves the right to discontinue, or change at any time, specification or designs without notice or incurring obligations.



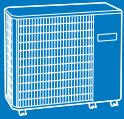

**SPECIFICATIONS:**

| NH4A4 and NH4H4 Outdoor Unit           |         |                                     |              |              |            |              |              |            |
|--|---------|-------------------------------------|--------------|--------------|------------|--------------|--------------|------------|
| Cooling Only                           |         |                                     |              |              |            |              |              |            |
| System                                 |         |                                     |              |              |            |              |              |            |
| Size                                   |         | 36                                  | 48           | 48           | 48         | 60           | 60           | 60         |
| Outdoor Model                          |         | NH4A436ALA                          | NH4A448AKA   | NH4A448AHA   | NH4A448ALA | NH4A460AKA   | NH4A460AHA   | NH4A460ALA |
| Electrical                             |         |                                     |              |              |            |              |              |            |
| Outdoor Voltage-Phase-Cycle            | V-Ph-Hz | 460-3-60                            | 208/230-1-60 | 208/230-3-60 | 460-3-60   | 208/230-1-60 | 208/230-3-60 | 460-3-60   |
| MCA (Outdoor)                          | A.      | 7.6                                 | 24.3         | 18.3         | 8.4        | 31.1         | 21.4         | 9.7        |
| MOCP - Fuse Rating (Outdoor)           | A.      | 15                                  | 40           | 30           | 15         | 50           | 35           | 15         |
| Operating Range                        |         |                                     |              |              |            |              |              |            |
| Cooling Outdoor DB Min - Max           | ° F     | 55~125 (-20° F w / Low-Ambient Kit) |              |              |            |              |              |            |
| Piping                                 |         |                                     |              |              |            |              |              |            |
| Total Piping Length                    | ft.     | 200'                                | 200'         | 200'         | 200'       | 200'         | 200'         | 200'       |
| Drop (OD above ID)                     | ft.     | 200'                                | 200'         | 200'         | 200'       | 200'         | 200'         | 200'       |
| Lift (OD below ID)                     | ft.     | 65'                                 | 65'          | 65'          | 65'        | 65'          | 65'          | 65'        |
| Outdoor Pipe Connection Size - Liquid  | in.     | 3/8                                 | 3/8          | 3/8          | 3/8        | 3/8          | 3/8          | 3/8        |
| Outdoor Pipe Connection Size - Suction | in.     | 7/8                                 | 7/8          | 7/8          | 7/8        | 1 1/8        | 1 1/8        | 1 1/8      |
| Refrigerant                            |         |                                     |              |              |            |              |              |            |
| Type                                   |         | R-410A                              | R-410A       | R-410A       | R-410A     | R-410A       | R-410A       | R-410A     |
| Charge                                 | lbs.    | 8.9                                 | 9            | 9            | 9          | 10.6         | 10.6         | 10.6       |
| Compressor                             |         |                                     |              |              |            |              |              |            |
| Type                                   |         | Scroll                              | Scroll       | Scroll       | Scroll     | Scroll       | Scroll       | Scroll     |
| Outdoor                                |         |                                     |              |              |            |              |              |            |
| Unit Width                             | in.     | 44.5                                | 44.5         | 44.5         | 44.5       | 44.5         | 44.5         | 44.5       |
| Unit Height                            | in.     | 37.1                                | 37.1         | 37.1         | 37.1       | 43.1         | 43.1         | 43.1       |
| Unit Depth                             | in.     | 17.1                                | 17.1         | 17.1         | 17.1       | 17.1         | 17.1         | 17.1       |
| Net Weight                             | lbs.    | 184                                 | 213          | 213          | 213        | 245          | 245          | 245        |
| Airflow                                | CFM     | 2,615                               | 2,615        | 2,615        | 2,615      | 2,785        | 2,785        | 2,785      |

**SPECIFICATIONS:**

| NH4A4 and NH4H4 Outdoor Unit           |         |                                     |              |              |              |              |            |
|--|---------|-------------------------------------|--------------|--------------|--------------|--------------|------------|
| Heat Pump                              |         |                                     |              |              |              |              |            |
| System                                 |         |                                     |              |              |              |              |            |
| Size                                   |         | 18                                  | 24           | 30           | 36           | 36           | 36         |
| Outdoor Model                          |         | NH4H418AKA                          | NH4H424AKA   | NH4H430AKA   | NH4H436AKA   | NH4H436AHA   | NH4H436ALA |
| Electrical                             |         |                                     |              |              |              |              |            |
| Outdoor Voltage-Phase-Cycle            | V-Ph-Hz | 208/230-1-60                        | 208/230-1-60 | 208/230-1-60 | 208/230-1-60 | 208/230-3-60 | 460-3-60   |
| MCA (Outdoor)                          | A.      | 11.8                                | 16.5         | 17.2         | 19           | 12.8         | 7.6        |
| MOCP - Fuse Rating (Outdoor)           | A.      | 20                                  | 25           | 30           | 30           | 20           | 15         |
| Operating Range                        |         |                                     |              |              |              |              |            |
| Cooling Outdoor DB Min - Max           | ° F     | 55~125 (-20° F w / Low-Ambient Kit) |              |              |              |              |            |
| Heating Outdoor DB Min - Max           | ° F     | 17~75                               | 17~75        | 17~75        | 17~75        | 17~75        | 17~75      |
| Piping                                 |         |                                     |              |              |              |              |            |
| Total Piping Length                    | ft.     | 200'                                | 200'         | 200'         | 200'         | 200'         | 200'       |
| Drop (OD above ID)                     | ft.     | 200'                                | 200'         | 200'         | 200'         | 200'         | 200'       |
| Lift (OD below ID)                     | ft.     | 65'                                 | 65'          | 65'          | 65'          | 65'          | 65'        |
| Outdoor Pipe Connection Size - Liquid  | in.     | 3/8                                 | 3/8          | 3/8          | 3/8          | 3/8          | 3/8        |
| Outdoor Pipe Connection Size - Suction | in.     | 5/8                                 | 3/4          | 3/4          | 7/8          | 7/8          | 7/8        |
| Refrigerant                            |         |                                     |              |              |              |              |            |
| Type                                   |         | R-410A                              | R-410A       | R-410A       | R-410A       | R-410A       | R-410A     |
| Charge                                 | lbs.    | 6.72                                | 7.67         | 12.1         | 12.3         | 12.3         | 12.3       |
| Compressor                             |         |                                     |              |              |              |              |            |
| Type                                   |         | Scroll                              | Scroll       | Scroll       | Scroll       | Scroll       | Scroll     |
| Outdoor                                |         |                                     |              |              |              |              |            |
| Unit Width                             | in.     | 36.9                                | 36.9         | 44.5         | 44.5         | 44.5         | 44.5       |
| Unit Height                            | in.     | 25.1                                | 31.1         | 37.1         | 37.1         | 37.1         | 37.1       |
| Unit Depth                             | in.     | 14.6                                | 14.6         | 17.1         | 17.1         | 17.1         | 17.1       |
| Net Weight                             | lbs.    | 150                                 | 161          | 196          | 197          | 197          | 197        |
| Airflow                                | CFM     | 1,285                               | 1,285        | 2,615        | 2,615        | 2,615        | 2,615      |

Manufacturer reserves the right to discontinue, or change at any time, specification or designs without notice or incurring obligations.

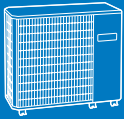

**SPECIFICATIONS:**

| NH4A4 and NH4H4 Outdoor Unit           |         |                                     |              |            |              |              |            |
|--|---------|-------------------------------------|--------------|------------|--------------|--------------|------------|
| Heat Pump                              |         |                                     |              |            |              |              |            |
| System                                 |         |                                     |              |            |              |              |            |
| Size                                   |         | 48                                  | 48           | 48         | 60           | 60           | 60         |
| Outdoor Model                          |         | NH4H448AKA                          | NH4H448AHA   | NH4H448ALA | NH4H460AKA   | NH4H460AHA   | NH4H460ALA |
| Electrical                             |         |                                     |              |            |              |              |            |
| Outdoor Voltage-Phase-Cycle            | V-Ph-Hz | 208/230-1-60                        | 208/230-3-60 | 460-3-60   | 208/230-1-60 | 208/230-3-60 | 460-3-60   |
| MCA (Outdoor)                          | A.      | 28.8                                | 18.6         | 8.6        | 33.4         | 22.9         | 10.6       |
| MOCP - Fuse Rating (Outdoor)           | A.      | 50                                  | 30           | 15         | 50           | 40           | 15         |
| Operating Range                        |         |                                     |              |            |              |              |            |
| Cooling Outdoor DB Min - Max           | ° F     | 55~125 (-20° F w / Low-Ambient Kit) |              |            |              |              |            |
| Heating Outdoor DB Min - Max           | ° F     | 17~75                               | 17~75        | 17~75      | 17~75        | 17~75        | 17~75      |
| Piping                                 |         |                                     |              |            |              |              |            |
| Total Piping Length                    | ft.     | 200'                                | 200'         | 200'       | 200'         | 200'         | 200'       |
| Drop (OD above ID)                     | ft.     | 200'                                | 200'         | 200'       | 200'         | 200'         | 200'       |
| Lift (OD below ID)                     | ft.     | 65'                                 | 65'          | 65'        | 65'          | 65'          | 65'        |
| Outdoor Pipe Connection Size - Liquid  | in.     | 3/8                                 | 3/8          | 3/8        | 3/8          | 3/8          | 3/8        |
| Outdoor Pipe Connection Size - Suction | in.     | 7/8                                 | 7/8          | 7/8        | 1 1/8        | 1 1/8        | 1 1/8      |
| Refrigerant                            |         |                                     |              |            |              |              |            |
| Type                                   |         | R-410A                              | R-410A       | R-410A     | R-410A       | R-410A       | R-410A     |
| Charge                                 | lbs.    | 10.95                               | 10.95        | 10.95      | 11.82        | 11.82        | 11.82      |
| Compressor                             |         |                                     |              |            |              |              |            |
| Type                                   |         | Scroll                              | Scroll       | Scroll     | Scroll       | Scroll       | Scroll     |
| Outdoor                                |         |                                     |              |            |              |              |            |
| Unit Width                             | in.     | 44.5                                | 44.5         | 44.5       | 44.5         | 44.5         | 44.5       |
| Unit Height                            | in.     | 43.1                                | 43.1         | 43.1       | 43.1         | 43.1         | 43.1       |
| Unit Depth                             | in.     | 17.1                                | 17.1         | 17.1       | 17.1         | 17.1         | 17.1       |
| Net Weight                             | lbs.    | 246                                 | 246          | 246        | 258          | 258          | 258        |
| Airflow                                | CFM     | 2,785                               | 2,785        | 2,785      | 2,785        | 2,785        | 2,785      |

# ACCESSORIES AND ADDITIONAL INFORMATION

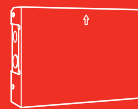

**24V Interface Kit  
for Ductless Systems**



**Wi-Fi® Kit**

## 24V INTERFACE KIT



# Improved Compatibility for Ductless Systems

## FEATURES

- Control the ductless system using a third-party thermostat<sup>1</sup>
- One 24V Interface Kit per indoor head<sup>2</sup>
- Keeps the Inverter compressor operating as a variable-speed system<sup>3</sup>
- Rated for outdoor and indoor mounting
- Dry mode contact for active dehumidification control
- Remote on/off contact
- Auxiliary heat control through the thermostat<sup>4</sup>
- Diagnostic code display LEDs
- Power supplied through the outdoor unit

## COMPATIBLE WITH:

- DLFPHA High Wall (p 17)
- DLFSHA High Wall (p 25)
- DLFEHA High Wall (p 37)
- DLFSCA Cassette (p 27)
- DLFLCA Cassette (p 55)
- DLFSDA Ducted (p 29)
- DLFLDA Ducted (p 57)
- DLFSFA Console (p 31)
- DLFLFA Console (p 59)

## KSAICo401230

The Second Generation 24V Interface Kit allows both single **and** multi-zone ductless systems to be compatible with and controlled by any third-party, single-stage conventional thermostat.<sup>1</sup> The 24V Interface Kit maintains the benefits of variable-speed technology, enabling increased efficiency and comfort for end users.<sup>3</sup>

## KEY BENEFITS

### Maintain Inverter Compressor Technology

The new 24V Interface keeps the Inverter compressor operating as a variable-speed system when using a third-party thermostat, making adjustments to maintain more consistent operation.

### Easy & Flexible Installation

Experience quick and easy installation between either a single or multi-zone outdoor unit and the fan coil. The interface can be installed either indoors or outdoors.

### Consumer Choice & Control

Consumers can choose to use either the included Remote Controller or their preferred third-party thermostat to control each ductless unit.

## ACCESSORIES

115V Transformer RCD#11203103000393 (Used only on ductless systems with 115V power.)



### COMPATIBILITY:

The Second Generation of the 24V Interface Kit model number KSAICo401230 is compatible with the ductless systems listed below. Before installation, check the compatibility of your ductless system. Product must be installed by a licensed HVAC technician.

| Type of Indoor Unit | Indoor Family Name | Single Zone Outdoor Family Name | Multi-Zone Outdoor Family Name | 208/230V                             |
|---------------------|--------------------|---------------------------------|--------------------------------|--------------------------------------|
| High Wall           | DLFPHA             | DLCPPRA                         | DLCMRA                         | All Sizes                            |
|                     | DFLSHA             | DLCSSRA                         | DLCMRA                         | All Sizes (see Note)                 |
|                     | DLFEHA             | DLCERA                          | DLCMRA                         | All Sizes                            |
| Cassette            | DLFSCA             | DLCSSRA                         | DLCMRA                         | All Sizes                            |
|                     | DLFLCA             | DLCLRA                          |                                | All Sizes                            |
| Ducted              | DLFSDA             | DLCSSRA                         | DLCMRA                         | All Sizes                            |
|                     | DLFLDA             | DLCLRA                          |                                | All Sizes Except Size 58 (See Note)  |
| Console             | DLFSFA             | DLCSSRA                         | DLCMRA                         | All Sizes Except Sizes 12 (See Note) |
|                     | DLFLFA             | DLCLRA                          |                                | All Sizes Except Size 58 (See Note)  |

**Note:** The Indoor unit requires an updated control board for compatibility with the 24V Interface Kit. High Wall units starting with Serial # V184810001 produced after Year 2018 Week 48 are shipped with the compatible control board. For other model numbers not shown on the table above, please contact your ductless representative. Ducted size 58 and Console sizes 12 and 58 starting with Serial # V191410001 are shipped with the compatible control board.

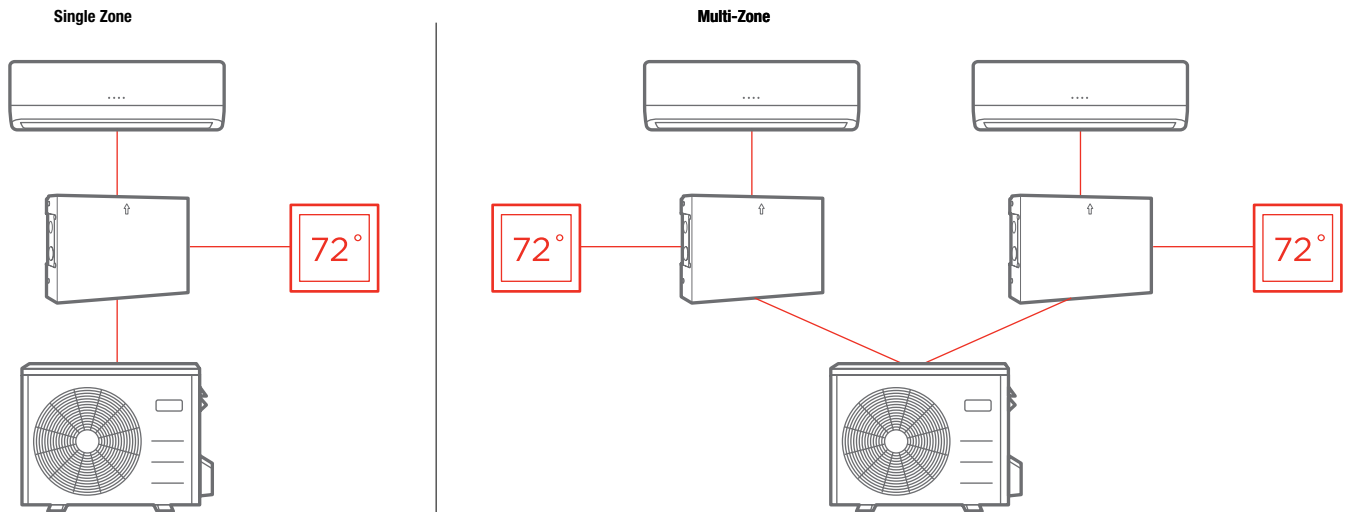

**Notes:**

<sup>1</sup>Third-party thermostats used with the 24V Interface Kit will replace the wireless Remote Controller included with the unit. Consult with dealer for more information.

<sup>2</sup>When using in a Multi-zone System not all the indoor heads require a 24V Interface Kit.

<sup>3</sup>A conventional 5-wire thermostat is required.

<sup>4</sup>A secondary output is necessary for auxiliary heat control.

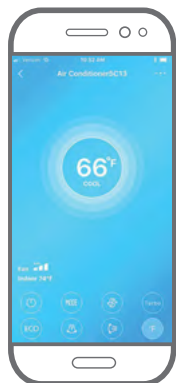

# Get Climate Control at Your Fingertips with **Wi-Fi®** Connectivity

## FEATURES

- Multiple modes, including Turbo, Cool, Heat, Dry, Fan, Auto and ECO (on compatible indoor units)
- Multiple fan speeds
- Sleep curve
- Up-down / right-left louver control (fixed or swing) on compatible indoor units
- Heating setback (46° F heating mode)
- Timer function for on/off scheduling

Heil® ductless indoor units are Wi-Fi® enabled through our Wi-Fi® Accessory Kits. Easily connect to network apps from your hand-held device for system control on the go.

## APPS

The Midea Air app is compatible with all kits and available in the App Store® for iOS devices and Google Play™ for Android devices.

## COMPATABILITY

The Wi-Fi® Accessory Kits are backwards compatible with indoor units of the same series. No serial number cutout.

| Wi-Fi® Accessories Model# | Description                            | DLFPHA | DLFSHA | DLFSCA<br>DLFLCA | DLFSDA<br>DLFLDA | DLFSFA<br>DLFLFA | DLFEHA |
|---------------------------|--|--------|--------|------------------|------------------|------------------|--------|
| KSAIF0101AAA              | Wi-Fi® High Wall Entry Tier 9/12/24k   |        |        |                  |                  |                  | •      |
| KSAIF0201AAA              | Wi-Fi® High Wall Entry Tier - 18k ONLY |        |        |                  |                  |                  | •      |
| KSAIF0401AAA              | Wi-Fi® Cassettes, Ducted, Console*     |        |        | •                | •                | •                |        |
| KSAIF0501AAA              | Wi-Fi® High Wall Mid-Tier              |        | •      |                  |                  |                  |        |
| KSAIF0601AAA              | Wi-Fi® High Wall High Tier             | •      |        |                  |                  |                  |        |

\*Not available for Console size 12

**Note:** The Follow Me function is not selectable from the app, only available on the Wired or Wireless Remote Controllers (sensing temperature from the controller). If this mode is previously activated with the controller, the Follow Me functions would be deactivated if the Operation Mode is adjusted or if the unit is turned through the app.





**COMPONENTS:**

All the components required for retrofit and operation are included with the Kits:

| Kit Part Number | Indoor Unit Type  | Components Included with Kit |   |                        |             |
|-----------------|---|------------------------------|---|------------------------|-------------|
|                 |   | Wi-Fi® USB Dongle            | Wi-Fi® Translator PCB                                 | USB Intermediate Cable | Display Box |
| KSAIF0101AAA    | High Wall Entry Tier 9/12/24k   | •                            |   | •                      | •           |
| KSAIF0201AAA    | High Wall Entry Tier 18k  | •                            |   | •                      | •           |
| KSAIF0401AAA    | Cassette (all sizes)<br>Ducted (all sizes)<br>Console (only sizes 18-58)* | •                            | •<br>Includes 19ft (6m) cable<br>and Wireless Control |                        |             |
| KSAIF0501AAA    | High Wall Mid-Tier (all sizes)  | •                            |   | •                      | •           |
| KSAIF0601AAA    | High Wall High Tier (all sizes)   | •                            |   |                        |             |

The individual components included with the kits are also available through RCD for replacement.

\*Not available for Console size 09 or 12.

**COMPATIBILITY:**

The use of the Wi-Fi® Accessory Kits on some indoor units would disable the ability to use the Wired Controllers in some instances:

|                      | Wired Control | Wireless Control |
|----------------------|---------------|------------------|
| High Tier High Wall  | •             | •                |
| Mid-Tier High Wall   |               | •                |
| Entry Tier High Wall |               | •                |
| Ducted               | •             | •                |
| Cassette             | •             | •                |
| Console 18-58        | •             | •                |

**Note:** The use of the 24V interface will disable system's Wi-Fi® module. Please consider using a Wi-Fi® Thermostat when using the 24V interface.

Wi-Fi® kits cannot be used on networks requiring a user login.





Wi-Fi® kits are only supported with networks using WPA-PSK/WPA2-PSK encryption and no encryption. WPA-PSK/WPA2-PSK encryption is recommended.

Please consult the installation instructions and Owners Manuals of the individual kits for more information.

## Dealer Support

**At Heil<sup>®</sup>, we know that you work hard to uphold your reputation as a trusted dealer and expert in your market. And that you must consistently offer innovative, efficient, high-performing products and services to keep customers happy and stay competitive.**

Essentially, we know what you need to be successful and we aim to create the best experience possible for you. That's why we provide all our dealers with top-notch factory support and team up with distributors to provide the tools needed for success, including:

-  **Training on ductless systems**
-  **Dealer loyalty programs and incentives**
-  **A dealer locator tool to help drive leads**
-  **Educational and sales resources**

It's all part of our commitment to helping you succeed and offer the greatest value and support to your customers.

**NEED ASSISTANCE? WE'RE HERE FOR YOU!**

**Online:** [Heil-HVAC.com](http://Heil-HVAC.com)



Get product information,  
find a dealer, download  
technical documents.

## Model Numbers, Tiers, Warranties & Controls

### MODEL NUMBER NOMENCLATURE

| Position                              | 1   | 2 | 3 | 4  | 5   | 6               | 7   | 8  | 9   | 10              | 11                           | 12 |
|---------------------------------------|---|---|---|--|---|-----------------|---|--|---|-----------------|------------------------------|----|
| Description                           | Type Unit   |   |   | Product Series   | Unit Type   | Major Series    | Unit Type   | Cooling Capacity<br>1,000 BTUh<br>(nominal)  | Max Number<br>of Zones<br>Connected to<br>Outdoor Unit              | Variations      | Electrical<br>Voltage-Phase  |    |
| Example                               | DLF =<br>Fan Coil Indoor<br><br>DLC =<br>Condensing<br>Unit Outdoor |   |   | P = Premium<br>(High Tier)<br>S = Standard<br>(Mid-Tier)<br>E = Entry Tier<br>M = Multi-Zone<br>L = Light Commercial | C = Cassette<br>D = Ducted<br>F = Console<br>H = High Wall<br>R = Outdoor | A =<br>Standard | A = Air<br>Conditioner<br>(Cooling Only)<br><br>H = Heat Pump | 09<br>12<br>18<br>24<br>30<br>36<br>48<br>58 | A = 1<br>B = 2<br>C = 3<br>D = 4<br>E = 5<br><br>X = Indoor<br>Unit | A =<br>Standard | J = 115-1<br><br>K=208/230-1 |    |
| Product<br>Example 1:<br>DLFPHAH09XAK | DLF =<br>Fan Coil<br>Indoor   |   |   | P = Premium<br>(High Tier)   | H = High Wall   | A =<br>Standard | H = Heat Pump   | 09   | X = Indoor<br>Unit  | A =<br>Standard | K=208/230-1                  |    |
| Product<br>Example 2:<br>DLCMRAH48EAK | DLC =<br>Condensing<br>Unit Outdoor                                 |   |   | M = Multi-Zone   | R = Outdoor   | A =<br>Standard | H = Heat Pump   | 48   | E = 5<br>Units  | A =<br>Standard | K=208/230-1                  |    |

### TIERS

| Product Tier | Series Name                 |
|--------------|-----------------------------|
| High Tier    | QuietComfort® Deluxe Series |
| Mid-Tier     | QuietComfort® Series        |
| Entry Tier   | Performance Series          |

### WARRANTY

| Application | Warranty                  |
|-------------|---------------------------|
| Residential | 10 Compressor / 10 parts* |
| Multifamily | 10 Compressor / 10 parts* |
| Commercial  | 7 Compressor / 7 Parts    |

\*With timely registration otherwise 5 years Compressor / 5 years parts.

### CONTROLS

|           |                    | Wired Controller |              |               |
|-----------|--------------------|------------------|--------------|---------------|
|           |                    | KSACN0101AAA     | KSACN0401AAA | KSACN0501AAA  |
| Function  | Timer Function     | X                |              |               |
|           | 7-Day Programmable |                  | X            | X             |
| High Wall | DLFPHA             |                  | ◦            |               |
|           | DLFSHA             | ◦                |              |               |
|           | DLFEHA             |                  | ◦            |               |
| Cassette  | DLFSCA             | ◦                |              | ◦             |
| Cassette  | DLFLCA             | ◦                |              | ◦             |
| Ducted    | DLFSDA             | ◦                |              | •             |
| Ducted    | DLFLDA             | ◦                |              | •             |
| Console   | DLFSFA             | ◦                | ◦ Size 12    | ◦ Sizes 18-24 |
| Console   | DLFLFA             | ◦                |              | ◦             |



|   |          |
|---|----------|
| • | Standard |
| ◦ | Optional |



## Standard Features Glossary

### 24-Hour Timer

Set the unit to start and stop automatically in a 24-hour period.

### Air Flow Panel

360° air outlet creates a soft and gentle air flow, which circulates throughout the whole space and provides an even temperature distribution in the room.

### Auto Defrosting

Prevents the evaporator from freezing and maintains dehumidifying effect in low temperature environments.

### Auto Restart Function

If the unit shuts off unexpectedly due to a power outage, it will restart with the previous settings automatically when the power resumes.

### Built-In Basepan Heater

A heating belt is fitted on the base plate of the outdoor unit to prevent water accumulation, which improves heat transfer efficiency.

### Built-In Condensate Lift Pump

A powerful, built-in drain pump can lift the condensing water up to 29 inches.

### Control Box Inside the Cassette

Easy maintenance with the box right inside the Cassette indoor unit. The integrated design provides a more compact size for easier installation.

### Convenient Temperature Controls

An intuitive, easy-to-use remote control displays temperature and other functions on a bright, clear LCD screen.

### Convertible Return Air Inlet

The air inlet can be installed either at the back or bottom of the Ducted unit, allowing for flexible installation to meet the need of each job.

### Crankcase Heater

A heating belt is fitted on the compressor to prevent frosting water accumulation, which improves heat transfer efficiency.

### Diamond Outdoor Unit Design

An innovative outdoor unit reduces noise level by more than 3 dB(A), with higher reliability, easier maintenance and improved performance.

### Eco Mode

Provides the ultimate energy savings and a comfortable sleeping environment with an intelligent eight-hour night cycle program that saves up to 60% of energy.

### Extra Low Temperature Heating

When it's cold outside, it's warm inside. High Tier and Mid-Tier Ductless Systems can be used as a primary heat source, with heat output down to -22° F.

### Follow Me

A temperature sensor built-in the Remote Controller will sense its surrounding temperature. The unit will adjust the room temperature more accurately to give you comfort. .

### High Ambient Cooling

The indoor space can be cooled to a desired, comfortable indoor temperature, even when outside temperatures reach up to 122° F.

### High Heating Operation

The High Tier and Mid-Tier systems can be a primary heat source, with high Heating down to -22° F, so when it's cold outside, it's warm inside.

### Independent Vane Control

Air flow direction from individual outlets can be controlled separately to achieve the optimal air flow based on a room's configuration.

### Inverter Technology

With the Inverter, the outdoor unit uses only the energy required to meet the desired temperature requirements of the indoor unit, thus lowering electric bills.

### Louver Position Memory

A horizontal louver will automatically move to the same position that was set the last time the unit was on.

### Low Ambient Cooling

Even when it's cold outside, but warm inside, the air conditioner will keep the area cool — perfect for serve rooms and commercial kitchens.

### Refrigerant Leak Detection

The indoor unit shows error code "EC" and stops automatically when refrigerant leakage is detected. This protects the compressor from high temperature damage due to refrigerant leakage.

### Single and Multi-Zone Compatible

A single zone outdoor unit can be paired with any indoor unit type. One multi-zone unit can be leveraged for up to five indoor units of any style.

### Sleep Mode

This function enables the system to automatically increase cooling or decrease heating by around four degrees for the first two hours, then holds steady for the next five hours. After that, it will switch off. This function achieves both energy savings and comfort at night.

### Stepless Frequency Adjustment

Precise control maintains a stable and constant room temperature while reducing the sound level and saving energy.

### Two-Way Draining

Connections, piping and drainage can be installed from both the left and right on the High Wall.

### Universal Matching

Get maximum flexibility with up to five different indoor units connected to one outdoor unit. Maintain a different temperature in each room for ultimate comfort, with the best indoor unit choice for each. Universal matching units are also available for single zone outdoor units. One outdoor unit can match any type of indoor unit.

### Wired Remote Controller

Compared to an infrared remote controller, a Wired Controller can be fixed on the wall and makes air conditioner operation more convenient for larger setups or Ducted units.





**Heil-HVAC.com**

---

**HEIL®**  
PO Box 128  
Lewisburg, TN 37091

©2020 International Comfort Products; Midea is a registered trademark owned by Midea Group Co., Ltd.  
Wi-Fi® is a registered trademark of Wi-Fi Alliance.  
ENERGY STAR® is a registered trademark of the U.S. EPA.

Part No. 328-12-0499-02  
07/2020

**HEIL®**  
HEATING & COOLING PRODUCTS  
*Depend On Us.*

