

# TEMPSTAR®

Heating and Cooling Products

2019

## *Residential* Condensed Catalog





# Table of Contents

---

Industry Certifications ..... 4

Residential Model Nomenclatures ..... 5

Residential Air Conditioners..... 25

Residential Heat Pumps ..... 47

90% Condensing Gas Furnaces ..... 63

80% Gas Furnaces ..... 71

Oil Furnaces..... 79

Fan Coils, Evaporator Coils and Blower Coils ..... 91

Ductless Systems ..... 115

Small Packaged Products ..... 133

Controls and IAQ ..... 155

Geothermal ..... 163

# Certifications

ICP Products meet or exceed industry standards.



As an ENERGY STAR® partner, ICP has determined that qualifying models meet ENERGY STAR guidelines for energy efficiency. Visit [www.energystar.gov](http://www.energystar.gov).



Use of the AHRI Certified TM Mark indicates a manufacturer's participation in the program. For verification of certification for individual products, go to [www.ahrirectory.org](http://www.ahrirectory.org).



Wi-Fi® is a trademark of Wi-Fi Alliance Corporation.

Apple and iOS are trademarks of Apple Inc., registered in the U.S. and other countries.

Android is a trademark of Google Inc.



**Residential  
Model  
Nomenclatures**

# 90% Gas Furnace

MODEL NUMBER IDENTIFICATION GUIDE										
	N	92	E	S	N	040	14	10	A	
DIGIT POSITION	1	2,3	4	5	6	7-9	10,11	12,13	14	15
F, G, N, R	<div style="border: 1px solid black; padding: 5px;"> <p style="text-align: center;"> </p> <p style="text-align: center;"> </p> <p style="text-align: center;"> </p> <p style="text-align: center;"> </p> <p style="text-align: center;"> </p> <p style="text-align: center;"> </p> <p style="text-align: center;"> </p> <p style="text-align: center;"> </p> <p style="text-align: center;"> </p> <p style="text-align: center;"> </p> <p style="text-align: center;"> </p> </div>									
<b>BRAND</b>										
80 - 80% AFUE 92 - 92% AFUE 95 - 95% AFUE 96 - 96% AFUE 97 - 97% AFUE										
<b>EFFICIENCY</b>										
C = Comm. Variable-Speed Constant Airflow (VCA) ECM E = Fixed-Speeds Constant Torque (FCT) ECM V = Variable-Speed Constant Torque (VCT) ECM										
<b>MOTOR TYPE</b>										
M - Modulating S - Single-Stage T - Two-Stage										
<b>HEATING STAGES</b>										
L = Low NOx M = Mobile/Manufactured Home N = Standard NOx U = Ultra-Low Nox										
<b>FEATURE</b>										
026 = 26,000 BTU/h 040 = 40,000 BTU/h 060 = 60,000 BTU/h										
<b>HEATING INPUT</b>										
14 = 14.2" 17 = 17.5" 21 = 21.0" 24 = 24.5"										
<b>CABINET WIDTH</b>										
08 = 800 CFM 10 = 1000 CFM 12 = 1200 CFM 14 = 1400 CFM 16 = 1600 CFM 20 = 2000 CFM 22 = 2200 CFM										
<b>COOLING CAPACITY</b>										
A, B, C, D...	<b>MAJOR SERIES</b>									
1, 2, 3, 4...	<b>MINOR SERIES</b>									



# Gas Furnace Accessories

ACCESSORIES MODEL NUMBER IDENTIFICATION GUIDE							
DIGIT POSITION	1	2	3	4	5, 6, 7	8, 9	10, 11
	<b>N</b>	<b>A</b>	<b>H</b>	<b>A</b>	<b>001</b>	<b>01</b>	<b>DH</b>
N = Non-Branded	<b>BRANDING</b>						
A = Accessory	<b>PRODUCT GROUP</b>						
H = Heating			<b>KIT USAGE</b>				
A = Original							
B = 2nd Generation				<b>MAJOR SERIES</b>			
Product Identifier Number							
Package Quantity							
Type of Kit (Example: DH = Draft Hood - Chimney Adapter)							

ACCESSORIES MODEL NUMBER IDENTIFICATION GUIDE – PRIOR TO 2010							
DIGIT POSITION	1	2	3	4	5, 6, 7	8, 9	
	<b>N</b>	<b>A</b>	<b>H</b>	<b>A</b>	<b>001</b>	<b>DH</b>	
N = Non-Branded	<b>BRANDING</b>						
A = Accessory	<b>PRODUCT GROUP</b>						
H = Heating			<b>KIT USAGE</b>				
A = Original							
B = 2nd Generation				<b>MAJOR SERIES</b>			
Product Identifier Number							
Type of Kit (Example: DH = Draft Hood - Chimney Adapter)							

## ACCESSORY PRODUCT IDENTIFIER ASSIGNMENT

AL = ALTERNATE INPUT KIT  
 BK = BLOWER KIT  
 CV = CONCENTRIC VENT KIT  
 DH = DRAFT HOOD  
 DK = DRAIN KIT  
 FB = WASHABLE FILTER BULK PACK  
 FF = FILTER FRAME  
 FK = FILTER KIT  
 FP = 10 PACK FILTER KIT  
 HL = HI ALTITUDE PROPANE KIT  
 LP = NATURAL TO PROPANE KIT  
 LV = LONG VENT KIT  
 NG = PROPANE TO NATURAL GAS KIT  
 NK = NEUTRALIZER KIT  
 VC = VENT GUARD  
 WK = TWINNING KIT  
 WL = WARNING LABEL REPLACEMENT KIT

REFER TO PRODUCT SPECIFICATIONS FOR COMPLETE ACCESSORY INFORMATION.



# Oil Furnace

OIL FURNACE MODEL NUMBER IDENTIFICATION GUIDE								
DIGIT POSITION	1	2	3	4	5, 6, 7	8	9, 10	11
	<b>N</b>	<b>O</b>	<b>M</b>	<b>V</b>	<b>098</b>	<b>J</b>	<b>12</b>	<b>A</b>
N = Burner included Blank = Burners and Accessories ordered separately								
O = Oil Furnace		<b>FUEL</b>						
C = Downflow/Horizontal D = Downflow/Horizontal H = Horizontal L = Lo-Boy M = Multiposition T = Upflow/Horizontal U = Upflow				<b>FEATURE</b>				
F = Front Breech R = Rear Breech V = Variable Motor				<b>FEATURE</b>				
098 = 98,000 BTU/hr 105 = 105,000 BTU/hr 106 = 106,000 BTU/hr 112 = 112,000 BTU/hr 154 = 154,000 BTU/hr 155 = 155,000 BTU/hr 156 = 156,000 BTU/hr 160 = 160,000 BTU/hr 210 = 210,000 BTU/hr 350 = 350,000 BTU/hr				<b>INPUT HEAT</b>				
A = 20 x 20 B = 24 x 24 C = 21-1/8 x 21-1/2 D = 19 x 20 E = 19 x 24 F = 20 x 24 G = 22 x 30 J = 16 x 19 K = 17-1/2 x 19				<b>SUPPLY PLENUM SIZE</b>				
08 = 800 CFM (max) 12 = 1200 CFM (max) 14 = 1400 CFM (max) 16 = 1600 CFM (max) 18 = 1800 CFM (max) 20 = 2000 CFM (max)				<b>COOLING AIRFLOW</b>				
SALES (MAJOR) REVISION DIGIT								

# Air Conditioners and Heat Pumps

OUTDOOR UNIT MODEL NUMBER IDENTIFICATION GUIDE (single phase)											
DIGIT POSITION	1	2	3	4	5, 6	7	8	9	10	11	12
	*	4	A	3	18	A	K	A	1	0	0
C, H, or T = Mainline N = Performance R = Entry		<b>BRANDING</b>									
V = Variable 4 = R-410A C = Communicating S = Single Stage Communicating X = R-410A		<b>REFRIGERANT</b>									
A = Air Conditioner H = Heat Pump		<b>TYPE</b>									
3 = 13 SEER 4 = 14 SEER 5 = 15 SEER 6 = 16 SEER 7 = 17 SEER 8 = 18 SEER 9 = 19 SEER		<b>NOMINAL EFFICIENCY</b>									
18 = 18,000 BTUH = 1½ tons 19 = 18,000 BTUH = 1½ tons 24 = 24,000 BTUH = 2 tons 25 = 24,000 BTUH = 2 tons 30 = 30,000 BTUH = 2½ tons 31 = 30,000 BTUH = 2½ tons 36 = 36,000 BTUH = 3 tons 37 = 36,000 BTUH = 3 tons 42 = 42,000 BTUH = 3½ tons 43 = 42,000 BTUH = 3½ tons 48 = 48,000 BTUH = 4 tons 49 = 48,000 BTUH = 4 tons 60 = 60,000 BTUH = 5 tons 61 = 60,000 BTUH = 5 tons		<b>NOMINAL CAPACITY</b>									
A = Standard Grille G = Coil Guard Grille C = Coastal		<b>FEATURES</b>									
K = 208/230-1-60		<b>VOLTAGE</b>									
Sales Code											
Engineering Revision											
Extra Digit											
Extra Digit											

# Ducted Horizontal Air Conditioners and Heat Pumps

OUTDOOR UNIT MODEL NUMBER IDENTIFICATION GUIDE											
Digit Position:	1,2	3	4	5	6,7	8	9	10	11	12	13
Example Part Number:	<b>NH</b>	<b>4</b>	<b>A</b>	<b>4</b>	<b>18</b>	<b>A</b>	<b>K</b>	<b>A</b>	<b>1</b>	<b>0</b>	<b>0</b>
Horizontal Condenser	<b>UNIT</b>										
4 = R-410A	<b>REFRIGERANT</b>										
A = Air Conditioner H = Heat Pump			<b>TYPE</b>								
4 = 14 SEER					<b>NOMINAL EFFICIENCY</b>						
18 = 18,000 BTUH = 1-1/2 tons 24 = 24,000 BTUH = 2 tons 30 = 30,000 BTUH = 2-1/2 tons 36 = 36,000 BTUH = 3 tons 42 = 42,000 BTUH = 3-1/2 tons 48 = 48,000 BTUH = 4 tons 60 = 60,000 BTUH = 5 tons											<b>NOMINAL CAPACITY</b>
A = Standard Grille											<b>FEATURES</b>
K = 208/230-1-60 H = 208/230-3-60 L = 460-3-60											<b>VOLTAGE</b>
Sales Code											
Engineering Revision											
Extra Digit											
Extra Digit											

## Air Conditioner and Heat Pumps Accessories

ACCESSORIES PART NUMBER IDENTIFICATION GUIDE								
DIGIT POSITION	1	2	3	4	5	6, 7	8, 9	10, 11
	<b>N</b>	<b>A</b>	<b>S</b>	<b>A</b>	<b>0</b>	<b>01</b>	<b>01</b>	<b>CH</b>
N = Non-Branded	<b>BRANDING</b>							
A = Accessory	<b>PRODUCT GROUP</b>							
S = Split System (AC & HP)			<b>KIT USAGE</b>					
A = Original B = 2nd Generation					<b>MAJOR SERIES</b>			
0 = Generic or Not Applicable 2 = R-22 4 = R-410A							<b>REFRIGERANT</b>	
Product Identifier Number								
Package Quantity								
Type of Kit (Example: CH = Crankcase Heater)								

REFER TO PRODUCT SPECIFICATIONS FOR COMPLETE ACCESSORY INFORMATION.

# Ductless

MODEL NUMBER NOMENCLATURE												
Digit Position:	1	2	3	4	5	6	7	8	9	10	11	12
EXAMPLE	D	L	C	E	R	A	A	1	2	A	A	K
DLF = Fan Coil Indoor DLC = Condensing Unit Outdoor				<b>TYPE UNIT</b>								
P = Premium (High Tier) S = Standard (Mid Tier) E = Entry Tier M = Multi-Zone L = Light Commercial				<b>PRODUCT SERIES</b>								
C = Cassette D = Ducted F = Console H = High Wall R = Outdoor				<b>UNIT TYPE</b>								
A = Standard				<b>MAJOR SERIES</b>								
A = Air Conditioner (Cooling Only) H = Heat Pump				<b>UNIT TYPE</b>								
09 12 18 24 30 36 48 58				<b>COOLING CAPACITY 1,000 BTUH (NOMINAL)</b>								
A = 1 B = 2 C = 3 D = 4 E = 5 X = Indoor Unit				<b>MAX NUMBER OF ZONES CONNECTED TO OUTDOOR UNIT</b>								
A = Standard				<b>VARIATIONS</b>								
J = 115-1 K = 208/230-1				<b>ELECTRICAL VOLTAGE PHASE</b>								

# Fan Coils

FVM, FXM, FEM, FSM, FCM Series FAN COIL MODEL NUMBER IDENTIFICATION								
DIGIT POSITION	1	2	3	4	5	6,7,8,9	10	11
	<b>F</b>	<b>V</b>	<b>M</b>	<b>4</b>	<b>X</b>	<b>1800</b>	<b>A</b>	<b>T</b>
F = Fan Coil	<b>UNIT</b>							
S = Standard PSC E = High-efficiency ECM C = Communicating X = ECM V = Variable-Speed								
U = Upflow M = Multiposition								
2 = R-22 4 = Environmentally Sound R-410A								
P = Piston Metering Device X = TXV								
1800 = 18,000 BTUH = 1½ tons 2400 = 24,000 BTUH = 2 tons 3000 = 30,000 BTUH = 2½ tons 3500 = 36,000 BTUH = 3 tons 3600 = 36,000 BTUH = 3 tons 4200 = 42,000 BTUH = 3½ tons 4800 = 48,000 BTUH = 4 tons 6000 = 60,000 BTUH = 5 tons								
A = Copper Tube, Aluminum Fin Evaporator Coil AL = Aluminum Tube, Aluminum Fin Evaporator Coil AT = Tin-Coated Copper Tubes, Aluminum Fin Evaporator Coil								

# Fan Coils

FAN COIL MODEL NUMBER IDENTIFICATION GUIDE								
	F	M	U	4	Z	2400	A	L
F = Fan Coil	TYPE		INSTALLATION TYPE			NOMINAL CAPACITY		
M = Multifamily								
U = Uncoiled								
C = Coiled								
4 = Environmentally Balanced R-410A			REFRIGERANT					
X = R-410A TXV & PSC Motor								
Z = R-410A TXV & ECM Motor			METERING DEVICE					
1800 = 18,000 BTUH = 1-1/2 tons								
2400 = 24,000 BTUH = 2 tons								
3000 = 30,000 BTUH = 2-1/2 tons								
3600 = 36,000 BTUH = 3 tons								
A = Marketing Revision						REVISION		
L = All Aluminum Coils						SALES CODE / FEATURES		

# Fan Coils – Accessories

FVM, FXM, FEM Series FAN COIL ACCESSORY PART NUMBER IDENTIFICATION GUIDE					
DIGIT POSITION	1,2	3,4	5,6	7,8,9	10
	<b>EB</b>	<b>AC</b>	<b>01</b>	<b>NCB</b>	<b>A</b>
EB = Evaporator Blower	<b>UNIT</b>				
AC = Accessory					
Product Identifier Number					
NCB = Non-Combustible Base Kit					
DFS = Down Flow Kit – Slope Coil					
DFA = Down Flow Kit – A Coil					
PLG = Power Plug (no heat kit)					
SPK = Single Point Wiring Kit					
FKS = Filter Kit Small					
FKM = Filter Kit Medium					
FKL = Filter Kit Large					
FKX = Filter Kit Extra Large					
CTK = Condensate Trap Kit (PVC pipe)					
Sales Code					<b>ACCESSORY TYPE</b>

REFER TO PRODUCT SPECIFICATIONS FOR COMPLETE ACCESSORY INFORMATION.

# Fan Coil – Electric Heaters

FVM, FXM, FEM Series FAN COIL ELECTRIC HEATER PART NUMBER IDENTIFICATION GUIDE						
DIGIT POSITION	1,2,3	4,5	6	7	8	9
	<b>EHK</b>	<b>05</b>	<b>A</b>	<b>K</b>	<b>N</b>	<b>1</b>
EHK = Electric Heater Kit						
05 = 5 kW						
07 = 7 kW						
09 = 9 kW						
10 = 10 kW						
15 = 15 kW						
18 = 18 kW						
20 = 20 kW						
25 = 25 kW						
30 = 30 kW						
		<b>NOMINAL HEAT VALUE</b>				
Sales Code						
K = 208 / 230 single-phase						
H = 208 / 230, 3-phase						
KC = 208 / 230, supplied as single-phase, field convertible to 3-phase						
HC = 208 / 230 supplied as 3-phase, field convertible to single-phase						
<b>VOLTAGE (60 Hz)</b>						
Product Identifier						
Engineering Revision						

FMA4P, FMA4X Series FAN COIL ELECTRIC HEATER PART NUMBER IDENTIFICATION GUIDE				
DIGIT POSITION	1,2,3	4	5,6	7
	<b>EHK</b>	<b>2</b>	<b>05</b>	<b>B</b>
EHK = Electric Heat Kit				
Sales Code				
05 = 5 kW				
08 = 7.5 kW				
10 = 11 kW				
<b>NOMINAL HEAT VALUE</b>				
Engineering Code				

FMU4Z, FMU4X, FMC4Z, FMC4X Series FAN COIL ELECTRIC HEATER MODEL NUMBER IDENTIFICATION GUIDE				
DIGIT POSITION	1,2,3	4	5,6	7
	<b>EHK</b>	<b>3</b>	<b>05</b>	<b>B</b>
EHK = Electric Heater Kit				
Sales Code				
05 = 5 kW				
08 = 7.5 kW				
10 = 10 kW				
<b>NOMINAL HEAT VALUE</b>				
Engineering Code				

REFER TO PRODUCT SPECIFICATIONS FOR COMPLETE ACCESSORY INFORMATION.

# Furnace Coils (Numerical Widths)

COIL MODEL NUMBER IDENTIFICATION GUIDE										
DIGIT POSITION	1	2	3	4	5	6,7	8	9,10	11	12
	<b>E</b>	<b>N</b>	<b>D</b>	<b>4</b>	<b>X</b>	<b>18</b>	<b>L</b>	<b>14</b>	<b>A</b>	<b>1</b>
E = Evaporator <b>UNIT</b>										
A = A Coil N = N Coil <b>TYPE</b>										
A = Uncased D = Cased Upflow/Downflow M = Cased Multiposition (Upflow/Downflow/Horizontal) W = Cased Upflow/Downflow for narrower furnaces H = Cased Horizontal <b>INSTALLATION</b>										
4 = Environmentally Sound R-410A <b>REFRIGERANT</b>										
P = Piston X = TXV <b>METERING DEVICE</b>										
18 = 18,000 BTUH = 1½ tons 19 = 18,000 BTUH = 1½ tons 24 = 24,000 BTUH = 2 tons 30 = 30,000 BTUH = 2½ tons 31 = 30,000 BTUH = 2½ tons 36 = 36,000 BTUH = 3 tons 37 = 36,000 BTUH = 3 tons 42 = 42,000 BTUH = 3½ tons 43 = 42,000 BTUH = 3½ tons 48 = 48,000 BTUH = 4 tons 60 = 60,000 BTUH = 5 tons 61 = 60,000 BTUH = 5 tons <b>NOMINAL CAPACITY</b>										
C = Copper Tube, Aluminum Fin Evaporator Coil L = Aluminum Tube, Aluminum Fin Evaporator Coil T = Tin-Coated Copper Tubes, Aluminum Fin Evaporator Coil <b>HAIRPIN MATERIAL</b>										
14 = 14-3/16" 17 = 17-1/2" 21 = 21" 24 = 24-1/2" <b>WIDTH</b>										
Sales Digit (Major Revision)										
Engineering Digit (Minor Revision)										



# Furnace Coils (B, F, J, L Widths)

COIL MODEL NUMBER IDENTIFICATION GUIDE									
	<b>E</b>	<b>D</b>	<b>M</b>	<b>4</b>	<b>X</b>	<b>18</b>	<b>B</b>	<b>AL</b>	<b>1</b>
E = Evaporator									
D = Deluxe									
M = Cased, Multiposition									
D = Cased Upflow / Downflow									
2 = R- 22									
4 = Environmentally Sound R- 410A									
X = TXV									
18 = 18,000 BTUH = 1- 1/2 tons									
24 = 24,000 BTUH = 2 tons									
30 = 30,000 BTUH = 2- 1/2 tons									
36 = 36,000 BTUH = 3 tons									
42 = 42,000 BTUH = 3- 1/2 tons									
48 = 48,000 BTUH = 4 tons									
60 = 60,000 BTUH = 5 tons									
61 = 60,000 BTUH = 5 tons									
B = 15.5"									
F = 19.1"									
J = 22.8"									
L = 24.5"									
AL = Aluminum									
Engineering Revision									

# Modular Blowers and Electric Furnace

MODULAR BLOWERS and ELECTRIC FURNACE MODEL NUMBER IDENTIFICATION GUIDE							
DIGIT POSITION	1	2	3,4	5,6	7,8	9	10
M = Cased Modular Blower	<b>M</b>	<b>V</b>	<b>08</b>	<b>00</b>	<b>14</b>	<b>C</b>	<b>1</b>
V = Variable-Speed ECM Motor 208/230-1-60 F = Electric Furnace 208/230-1-60 B = Blower Cabinet 115-1-60	<b>UNIT</b>						
08 = 800 (2 ton) 12 = 1200 (3 ton) 16 = 1600 (4 ton) 20 = 2000 (5 ton)			<b>NOMINAL CFM</b>				
00 = No Electric Heat			<b>FACTORY INSTALLED ELECTRIC HEAT</b>				
14 = 14-1/2" 17 = 17-1/2" 21 = 21" 24 = 24-1/2"					<b>COIL WIDTH MATCH</b>		
Sales Code							
Engineering Revision							

MODULAR BLOWERS and ELECTRIC FURNACE ACCESSORY PART NUMBER IDENTIFICATION GUIDE							
DIGIT POSITION	1	2	3	4,5,6	7,8	9	10
A = Accessory	<b>A</b>	<b>M</b>	<b>F</b>	<b>001</b>	<b>DF</b>	<b>A</b>	<b>1</b>
C = Cooling H = Heating M = Multi-use (heating and cooling) X = Special	<b>PRODUCT TYPE</b>						
Series							
Product Identifier Number							
DF = Downflow Kit OT = 2-stage Outdoor Thermostat SP = Single Point Wiring Kit	NH= No Heat Kit				<b>ACCESSORY TYPE</b>		
Sales Code							
Engineering Revision							

# Small Package Units

MODEL NUMBER IDENTIFICATION GUIDE										
DIGIT POSITION	1	2	3	4	5,6	7,8,9	10	11,12	13	14
	<b>P</b>	<b>G</b>	<b>S</b>	<b>4</b>	<b>36</b>	<b>060</b>	<b>K</b>	<b>GP</b>	<b>0</b>	<b>D</b>
P = Package	<b>UNIT</b>									
A = Air Conditioner										
H = Heat Pump										
D = Dual Fuel										
G = Gas/Electric		<b>TYPE</b>								
D = Standard										
J = Dedicated Horizontal (AC or HP only)										
S = Mainline with SS HX			<b>TIER</b>							
4 = 14										
5 = 15					<b>SEER</b>					
24 = 24,000 BTUH = 2 Tons										
30 = 30,000 BTUH = 2.5 Tons										
36 = 36,000 BTUH = 3 Tons										
42 = 42,000 BTUH = 3.5 Tons										
48 = 48,000 BTUH = 4 Tons										
60 = 60,000 BTUH = 5 Tons					<b>NOMINAL COOLING BTUH</b>					
000 = N/A										
040 = 40,000										
060 = 60,000										
090 = 90,000										
115 = 115,000										
120 = 120,000										
130 = 130,000					<b>NOMINAL HEATING BTUH (input)*</b>					
K = 208/230-1-60							<b>VOLTAGE</b>			
00 = No Options										
TP = Tin-Plated Evap Main Tubes										
GP = Tin-Plated Evap Main Tubes plus Stainless Steel Heat Exchanger *							<b>FACTORY INSTALLED OPTIONS</b>			
0 = Standard										
1 = Low NOx *									<b>FEATURE CODE</b>	
Sales Model Digit										

\* Gas/electric or Dual Fuel models only

# Small Package Units

MODEL NOMENCLATURE										
	1	2	3,4	5,6	7,8,9	10	11,12	13	14	15
<b>MODEL SERIES</b>	<b>P</b>	<b>G</b>	<b>R5</b>	<b>36</b>	<b>090</b>	<b>K</b>	<b>GS</b>	<b>0</b>	<b>C</b>	<b>1</b>
P = Package A = Air Conditioner H = Heat Pump G = Gas/Electric										
<b>TYPE</b>										
R5 = Mainline										
<b>TIER</b>										
24 = 24,000 BTUH = 2 Tons 36 = 36,000 BTUH = 3 Tons 48 = 48,000 BTUH = 4 Tons 60 = 60,000 BTUH = 5 Tons										
<b>NOMINAL CLG CAPACITY</b>										
000 = no factory heat 040 = 40,000 BTU/hr 060 = 60,000 BTU/hr 090 = 90,000 BTU/hr 115 = 115,000 BTU/hr 130 = 127,000 or 130,000 BTU/hr										
<b>NOMINAL HTG BTUH (input)</b>										
K = 208/230-1-60 H = 208/230-3-60										
<b>VOLTAGE</b>										
GC = Low Cabinet Air Leakage plus Tin-Coated Copper Evap Main Tubes GP = Tin-Coated Copper Evap Main Tubes plus Stainless Steel Heat Exchanger GS = Stainless Steel Heat Exchanger										
<b>FACTORY INSTALLED OPTIONS</b>										
0 = Standard 1 = Low NOx										
<b>FEATURE CODE</b>										
Sales Model Digit Engineering Digit										

MODEL NOMENCLATURE										
	1	2	3,4	5,6	7,8,9	10	11,12	13	14	15
<b>MODEL SERIES</b>	<b>P</b>	<b>H</b>	<b>R5</b>	<b>36</b>	<b>000</b>	<b>K</b>	<b>00</b>	<b>0</b>	<b>A or B</b>	<b>1</b>
P = Package H = Heat Pump										
<b>TIER</b>										
R5 = Mainline										
24 = 24,000 BTUH = 2 Tons 30 = 30,000 BTUH = 2.5 Tons 36 = 36,000 BTUH = 3 Tons 42 = 42,000 BTUH = 3.5 Tons 48 = 48,000 BTUH = 4 Tons 60 = 60,000 BTUH = 5 Tons										
<b>NOMINAL CLG CAPACITY</b>										
<b>NOMINAL HTG BTUH (input)</b>										
000 = no factory heat										
K = 208/230-1-60 H = 208/230-3-60										
<b>VOLTAGE</b>										
00 = No options AD = Advanced Dehumidification plus Tin-Plated Copper Evap Main Tubes LC = Low Cabinet Air Leakage plus Tin-Plated Copper Evap Main Tubes TP = Tin-Plated Evaporator Main Tubes										
<b>FACTORY INSTALLED OPTIONS</b>										
<b>FEATURE CODE</b>										
0 = Standard Sales Model Digit Engineering Digit										

# Geothermal Heat Pump

UNIT MODEL NUMBER IDENTIFICATION GUIDE												
Digit Position:	1,2	3,4,5	6	7	8	9	10	11	12	13	14,15	16
Example Part Number:	<b>HB</b>	<b>024</b>	<b>V</b>	<b>T</b>	<b>L</b>	<b>C</b>	<b>D</b>	<b>C</b>	<b>C</b>	<b>1</b>	<b>XX</b>	<b>1</b>
HB = Geothermal Package <div style="text-align: right;"><b>MODEL</b></div>												
018 = 18,000 BTUH = 1.5 tons 024 = 24,000 BTUH = 2 tons 030 = 30,000 BTUH = 2.5 tons 036 = 36,000 BTUH = 3 tons 042 = 42,000 BTUH = 3.5 tons 048 = 48,000 BTUH = 4 tons 060 = 60,000 BTUH = 5 tons <div style="text-align: right;"><b>NOMINAL CAPACITY</b></div>												
V = Vertical H = Horizontal <div style="text-align: right;"><b>CABINET CONFIGURATION</b></div>												
T = Top (vertical) E = End (Horizontal) S = Side (horizontal) <div style="text-align: right;"><b>DISCHARGE AIR CONFIGURATION</b></div>												
L = Left R = Right <div style="text-align: right;"><b>RETURN AIR CONFIGURATION</b></div>												
C = Copper (source) N = Cupronickel (source) <div style="text-align: right;"><b>COAX OPTIONS</b></div>												
D = with Desuperheater X = without Desuperheater <div style="text-align: right;"><b>HOT WATER OPTION</b></div>												
C = Constant Torque X-13 <div style="text-align: right;"><b>FAN/MOTOR OPTIONS</b></div>												
C = Coated fins, Tin-Plated Hair Pins <div style="text-align: right;"><b>AIR COIL COATING</b></div>												
1 = 208-230/60/1										<b>VOLTAGE</b>		
XX										<b>FUTURE USE</b>		
1										<b>ENGINEERING DIGIT</b>		

# Geothermal Heat Pump

<b>OUTDOOR UNIT MODEL NUMBER IDENTIFICATION GUIDE (single-phase)</b>												
Digit Position:	1,2	3,4,5	6	7	8	9	10	11	12	13	14,15	16
Example Part Number:	<b>HP</b>	<b>024</b>	<b>V</b>	<b>T</b>	<b>L</b>	<b>C</b>	<b>D</b>	<b>E</b>	<b>T</b>	<b>1</b>	<b>XX</b>	<b>1</b>
HP = Geothermal Package <div style="text-align: right;"><b>MODEL</b></div>												
024 = 24,000 BTUH = 2 tons 036 = 36,000 BTUH = 3 tons 048 = 48,000 BTUH = 4 tons 060 = 60,000 BTUH = 5 tons 072 = 72,000 BTUH = 6.5 tons <div style="text-align: right;"><b>NOMINAL CAPACITY</b></div>												
V = Vertical H = Horizontal C = Counterflow <div style="text-align: right;"><b>CABINET CONFIGURATION</b></div>												
T = Top (vertical) B = Bottom (vertical) E = End (Horizontal) S = Side (horizontal) <div style="text-align: right;"><b>DISCHARGE AIR CONFIGURATION</b></div>												
L = Left R = Right <div style="text-align: right;"><b>RETURN AIR CONFIGURATION</b></div>												
C = Copper (source) N = Cupronickel (source) <div style="text-align: right;"><b>COAX OPTIONS</b></div>												
D = with Desuperheater X = without Desuperheater <div style="text-align: right;"><b>HOT WATER OPTION</b></div>												
E = ECM <div style="text-align: right;"><b>FAN/MOTOR OPTIONS</b></div>												
T = Tin-Plated Hair Pins <div style="text-align: right;"><b>AIR COIL COATING</b></div>												
1 = 208-230/60/1 <div style="text-align: right;"><b>VOLTAGE</b></div>												
XX <div style="text-align: right;"><b>FUTURE USE</b></div>												
1 <div style="text-align: right;"><b>ENGINEERING DIGIT</b></div>												

# Geothermal Split Heat Pump

UNIT MODEL NUMBER IDENTIFICATION GUIDE												
Digit Position:	1,2	3,4,5	6	7	8	9	10	11	12	13	14,15	16
Example Part Number:	<b>HS</b>	<b>024</b>	<b>S</b>	<b>X</b>	<b>X</b>	<b>C</b>	<b>D</b>	<b>X</b>	<b>X</b>	<b>1</b>	<b>XX</b>	<b>1</b>
HS = Geothermal Split	<b>MODEL</b>											
024 = 24,000 BTUH = 2 tons 036 = 36,000 BTUH = 3 tons 048 = 48,000 BTUH = 4 tons 060 = 60,000 BTUH = 5 tons	<b>NOMINAL CAPACITY</b>											
S = Split System	<b>CABINET CONFIGURATION</b>											
X = None (split or water-to-water)	<b>DISCHARGE AIR CONFIGURATION</b>											
X = None (split or water-to-water)	<b>RETURN AIR CONFIGURATION</b>											
C = Copper (source) N = Cupronickel (source)	<b>COAX OPTIONS</b>											
D = with Desuperheater X = without Desuperheater	<b>HOT WATER OPTION</b>											
X = None	<b>FAN/MOTOR OPTIONS</b>											
X = No air coil	<b>AIR COIL COATING</b>											
1 = 208-230/60/1	<b>VOLTAGE</b>											
XX	<b>FUTURE USE</b>											
1	<b>ENGINEERING DIGIT</b>											

# Water-to-Water Geothermal Heat Pump

UNIT MODEL NUMBER IDENTIFICATION GUIDE												
Digit Position:	1,2	3,4,5	6	7	8	9	10	11	12	13	14,15	16
Example Part Number:	<b>HW</b>	<b>024</b>	<b>W</b>	<b>X</b>	<b>X</b>	<b>D</b>	<b>D</b>	<b>X</b>	<b>X</b>	<b>1</b>	<b>XX</b>	<b>1</b>
HW = Geothermal Water-to-water <b>MODEL</b>												
024 = 24,000 BTUH = 2 tons 036 = 36,000 BTUH = 3 tons 048 = 48,000 BTUH = 4 tons 060 = 60,000 BTUH = 5 tons 072 = 72,000 BTUH = 6 tons <b>NOMINAL CAPACITY</b>												
W = Water-to-water <b>CABINET CONFIGURATION</b>												
X = None (split or water-to-water) <b>DISCHARGE AIR CONFIGURATION</b>												
X = None (split or water-to-water) <b>RETURN AIR CONFIGURATION</b>												
D = Copper (source & load) E = Cupronickel (source & load) F = Copper (source), Cupronickel (load) G = Cupronickel (source), Copper (load) <b>COAX OPTIONS</b>												
D = with Desuperheater X = without Desuperheater <b>HOT WATER OPTION</b>												
X = None <b>FAN/MOTOR OPTIONS</b>												
X = No air coil <b>AIR COIL COATING</b>												
1 = 208-230/60/1										<b>VOLTAGE</b>		
XX										<b>FUTURE USE</b>		
1										<b>ENGINEERING DIGIT</b>		



# Residential Air Conditioners

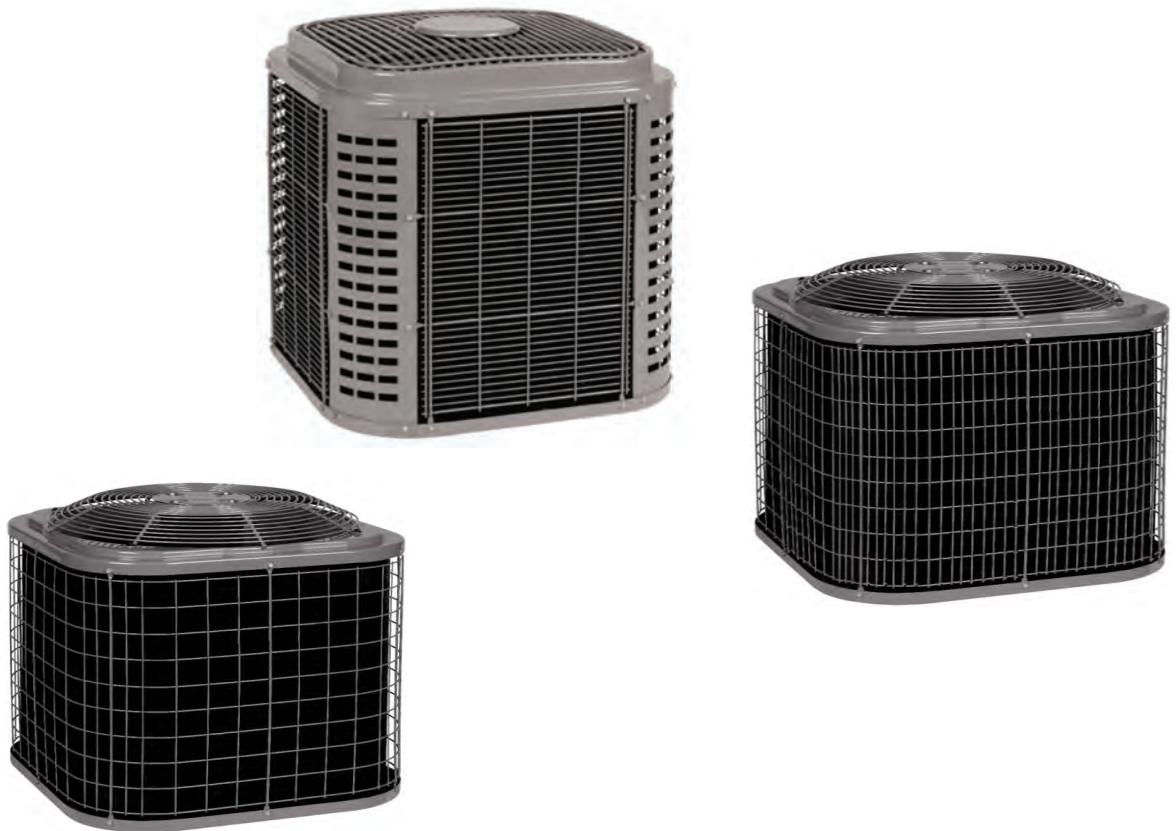

# TVA9

## High-Efficiency up to 19.0 SEER Variable-Speed Air Conditioner with Observer®/Ion™ Communicating Control System

2 – 5 Tons Split System  
208 / 230 Volt, Single-Phase, 60 Hz



Recommended (Sold separately)



### Refrigeration Circuit

- Variable-speed compressor operates at five stages with capacity range as wide as 25 - 100%
- High-pressure switch
- Suction pressure transducer
- Pressure equalizer valve for easy starting
- Compressor discharge temperature sensor
- Coil temperature sensor
- Copper tube/aluminum fin coil

### Performance

- Up to 13.0 EER
- Integrated inverter control enables five-stage operation with complete Observer/Ion Communicating System
- Ion™ System Control or Observer Wall Control with version 5.0 or newer software required for five-stage operation
- Also capable of two-stage operation with two-stage thermostat
- Self-configuring installation with Observer/Ion Communicating Wall Control
- Compact ECM fan motor driven by integrated inverter control
- Outdoor temperature sensor factory installed
- High performance compressor sound shield standard
- Isolation compressor grommets
- Enhanced dehumidification

### Easy-to-Install and Service

- Text based diagnostics with Observer/Ion Communicating Wall Control
- Only two control wires required from communicating indoor unit to condenser
- External high- and low-refrigerant service ports
- Factory charged with R-410A refrigerant
- Adjustments for min and max staging with Observer/Ion Communicating Wall Control

### Built to Last

- High-gloss, baked-on powder coat finish over galvanized steel
- Post-painted (black) coil fins
- Coated inlet grille with 3/8" (10mm) spacing for extra protection (hail guard)
- Corner posts for extra strength and style

### Warranty\*

- 10-year No Hassle Replacement™ limited warranty
- Five-year parts limited warranty (including compressor and coil)
  - With timely registration, an additional five-year parts limited warranty (including compressor and coil)



Qualifying models only.

\* For residential applications only. See warranty certificate for complete details and restrictions, including warranty coverage for other applications.

### Unit Performance Data

Model Number	Size (tons)	Nominal Btu/hr	Min. Circuit Ampacity	Max. Fuse or Breaker	Operating Dimensions H x W x D (sq) in (mm)	Ship/Operating Weight lbs (kg)
TVA924GKA	2	24,000	13.5	20	31-13/16 x 23-1/8 x 23-1/8 (807 x 587 x 587)	150 /128 (68/58)
TVA925GKA†	2	24,000	23.6	40	38-1/2 x 23-1/8 x 23-1/8 (980 x 587 x 587)	177/152 (80/69)
TVA936GKA	3	36,000	24.2	40	38-1/2 x 23-1/8 x 23-1/8 (980 x 587 x 587)	177/152 (80/69)
TVA937GKA†	3	36,000	26.0	40	38-15/16 x 31-3/16 x 31-3/16 (989 x 242 x 242)	242/205 (110/93)
TVA948GKA	4	48,000	27.3	40	38-15/16 x 31-3/16 x 31-3/16 (989 x 242 x 242)	242/205 (110/93)
TVA949GKA†	4	48,000	26.0	40	43-11/16 x 35 x 35 (1111 x 889 x 889)	285/249 (129/113)
TVA960GKA	5	60,000	40.0	60	42-5/16 x 31-3/16 x 31-3/16 (1075 x 792 x 792)	268/229 (121/104)

† Meets ENERGY STAR® criteria when matched with appropriate coil.



# TCA7

## High-Efficiency up to 17.0 SEER Two-Stage Air Conditioner with Observer®/Ion™ Communicating Control System



Recommended (Sold separately)

**2 – 5 Tons Split System**  
208 / 230 Volt, Single-Phase, 60 Hz

### Refrigeration Circuit

- Copeland Scroll™ UltraTech™ compressors on all models
- Filter drier supplied with every unit for field installation
- External high- and low-refrigerant service ports
- High- and low-pressure switches
- Copper tube/aluminum fin coil

### Performance

- Communicating, self-configuring operation when used with Observer/Ion Communicating Wall Control
- Outdoor temperature sensor factory installed
- Ball bearing PSC fan motors on all models
- High performance compressor sound shield standard
- Isolation compressor grommets

### Easy-to-Install and Service

- Text based diagnostics with Observer/Ion Communicating Wall Control
- Only two control wires required from communicating indoor unit to condenser
- Easy access service valves on all models
- Innovative control box design
- Only two screws to access control panel
- Factory charged with R-410A refrigerant

### Built to Last

- High-gloss, baked-on powder coat finish over galvanized steel
- Post-painted (black) coil fins
- Coated, weather-resistant cabinet screws
- Coated inlet grille with 3/8" (10mm) spacing for extra protection (hail guard)
- Corner posts for extra strength and style

### Warranty\*

- 10-year No Hassle Replacement™ limited warranty
- Five-year parts limited warranty (including compressor and coil) – With timely registration, an additional five-year parts limited warranty (including compressor and coil)

\* For residential applications only. See warranty certificate for complete details and restrictions, including warranty coverage for other applications.



### Unit Performance Data

Model Number	Size (tons)	Nominal Btu/hr	Min. Circuit Ampacity	Max. Fuse or Breaker	Operating Dimensions H x W x D (sq) in (mm)	Ship/Operating Weight lbs (kg)
TCA724GKA	2	24,000	14.5	20	35-7/16 x 31-3/16 x 31-3/16 (900 x 792 x 792)	222/183 (101/83)
TCA736GKA	3	36,000	19.8	25	35-7/16 x 31-3/16 x 31-3/16 (900 x 792 x 792)	256/217 (116/98)
TCA748GKA	4	48,000	27.8	40	40-1/8 x 35 x 35 (1019 x 889 x 889)	326/283 (148/128)
TCA760GKB	5	60,000	37.3	60	40-1/8 x 35 x 35 (1019 x 889 x 889)	327/284 (148/129)

# TSA6

## Up to 16.0 SEER Single-Stage Air Conditioner with Observer® /Ion™ Communicating Control System

1-1/2 – 5 Tons Split System  
208 / 230 Volt, Single-Phase, 60 Hz



Recommended (Sold separately)



### Refrigeration Circuit

- Scroll compressors on all models
- Filter drier supplied with every unit for field installation
- External high- and low-refrigerant service ports
- Copper tube/aluminum fin coil

### Performance

- Communicating, self-configuring operation when used with Observer/Ion Communicating Wall Control
- Outdoor temperature sensor factory installed
- Compressor sound blanket standard
- Isolation compressor grommets

### Easy-to-Install and Service

- Text based diagnostics with Observer/Ion Communicating Wall Control
- Easy access service valves on all models
- Innovative control box design
- High- and low-pressure switches
- Fan motor in-line disconnect plug
- Only two screws to access control panel
- Factory charged with R-410A refrigerant

### Built to Last

- High-gloss, baked-on powder coat finish over galvanized steel
- Post-painted (black) coil fins
- Coated, weather-resistant cabinet screws
- Coated inlet grille with 3/8" (10mm) spacing for extra protection (hail guard)
- Corner posts for extra strength and style

### Warranty\*

- Five-year No Hassle Replacement™ limited warranty
- Five-year parts limited warranty (including compressor and coil)
  - With timely registration, an additional five-year parts limited warranty (including compressor and coil)

\* For residential applications only. See warranty certificate for complete details and restrictions, including warranty coverage for other applications.

### Unit Performance Data

Model Number	Size (tons)	Nominal Btu/hr	Min. Circuit Ampacity	Max. Fuse or Breaker	Operating Dimensions H x W x D (sq) in (mm)	Ship/Operating Weight lbs (kg)
TSA618GKA	1-1/2	18,000	11.8	20	28-9/16 x 31-3/16 x 31-3/16 (726 x 792 x 792)	213/176 (96/80)
TSA624GKA	2	24,000	17.6	25	28-9/16 x 31-3/16 x 31-3/16 (726 x 792 x 792)	212/176 (96/80)
TSA630GKA	2-1/2	30,000	16.7	25	32 x 31-3/16 x 31-3/16 (813 x 792 x 792)	223/187 (101/85)
TSA636GKA	3	36,000	18.1	30	29-7/8 x 35 x 35 (760 x 889 x 889)	243/200 (110/91)
TSA642GKA	3-1/2	42,000	23.6	40	40-1/8 x 35 x 35 (1019 x 889 x 889)	297/253 (135/115)
TSA648GKA	4	48,000	26.1	40	40-1/8 x 35 x 35 (1019 x 889 x 889)	340/295 (155/114)
TSA660GKB	5	60,000	32.4	50	46-7/8 x 35 x 35 (1191 x 889 x 889)	374/327 (169/148)



Recommended (Sold separately)

# TSA5

## Up to 15.5 SEER Single-Stage Air Conditioner with Observer® /Ion™ Communicating Control System

1-1/2 – 5 Tons Split System  
208 / 230 Volt, Single-Phase, 60 Hz

### Refrigeration Circuit

- Copeland Scroll™ compressors on all models
- Filter drier supplied with every unit for field installation
- External high- and low-refrigerant service ports
- Copper tube/aluminum fin coil

### Performance

- Communicating, self-configuring operation when used with Observer/Ion Communicating Wall Control
- Outdoor temperature sensor factory installed
- Compressor sound blanket standard
- Isolation compressor grommets

### Easy-to-Install and Service

- Text based diagnostics with Observer/Ion Communicating Wall Control
- Easy access service valves on all models
- Innovative control box design
- High- and low-pressure switches
- Fan motor in-line disconnect plug
- Only two screws to access control panel
- Factory charged with R-410A refrigerant

### Built to Last

- High-gloss, baked-on powder coat finish over galvanized steel
- Post-painted (black) coil fins
- Coated, weather-resistant cabinet screws
- Coated inlet grille with 3/8" (10mm) spacing for extra protection (hail guard)
- Corner posts for extra strength and style

### Warranty\*

- Three-year No Hassle Replacement™ limited warranty
- Five-year parts limited warranty (including compressor and coil)
  - With timely registration, an additional five-year parts limited warranty (including compressor and coil)

\* For residential applications only. See warranty certificate for complete details and restrictions, including warranty coverage for other applications.

### Unit Performance Data

Model Number	Size (tons)	Nominal Btu/hr	Min. Circuit Ampacity	Max. Fuse or Breaker	Operating Dimensions H x W x D (sq) in (mm)	Ship/Operating Weight lbs (kg)
TSA518GKA	1-1/2	18,000	11.8	20	28-11/16 x 31-3/16 x 31-3/16 (729 x 793 x 793)	213/176 (97/80)
TSA524GKA	2	24,000	17.6	25	28-11/16 x 31-3/16 x 31-3/16 (729 x 793 x 793)	213/176 (97/80)
TSA530GKA	2-1/2	30,000	16.8	25	32-1/8 x 31-3/16 x 31-3/16 (816 x 793 x 793)	199/135 (90/75)
TSA536GKA	3	36,000	18.1	30	35-1/2 x 31-3/16 x 31-3/16 (902 x 793 x 793)	211/177 (96/80)
TSA542GKA	3-1/2	42,000	22.3	35	28-11/16 x 31-3/16 x 31-3/16 (729 x 793 x 793)	237/203 (108/92)
TSA548GKA	4	48,000	20.8	35	28-11/16 x 31-3/16 x 31-3/16 (729 x 793 x 793)	238/204 (108/93)
TSA560GKA	5	60,000	27.5	40	32-1/8 x 31-3/16 x 31-3/16 (816 x 793 x 793)	257/225 (117/102)

# T4A3

## Efficient 13.0 SEER Air Conditioner Environmentally Balanced R-410A Refrigerant

2 – 5 Tons Split System  
208 / 230 Volt, Single-Phase, 60 Hz



### Refrigeration Circuit

- Copeland Scroll™ compressors on all models
- Filter drier supplied with every unit for field installation
- External high- and low-refrigerant service ports
- Copper tube/aluminum fin coil

### Performance

- Two-speed fan motors factory wired on some models
- Compressor Sound Jacket standard
- Ion™ system control compatible with communicating relay module (see SYST0101CW Product Specification for details)

### Easy-to-Install and Service

- Comfort Alert™ diagnostics device on some models
- Easy access service valves on all models
- Innovative control box design
- High- and low-pressure switches
- Fan motor in-line disconnect plug
- Only two screws to access control panel
- Factory charged with R-410A refrigerant

### Built to Last

- High-gloss, baked-on powder coat finish over galvanized steel
- Post-painted (black) coil fins
- Coated, weather-resistant cabinet screws
- Coated inlet grille with 3/8" (10mm) spacing for extra protection (hail guard)
- Corner posts for extra strength and style

### Warranty\*

- One-year No Hassle Replacement™ limited warranty
- Five-year compressor limited warranty
- Five-year parts limited warranty (including compressor and coil)
  - With timely registration, an additional five-year parts limited warranty (including compressor and coil)

\* For residential applications only. See warranty certificate for complete details and restrictions, including warranty coverage for other applications.

### Unit Performance Data

Model Number	Size (tons)	Nominal Btu/hr	Min. Circuit Ampacity	Max. Fuse or Breaker	Operating Dimensions H x W x D (sq) in (mm)	Ship/Operating Weight lbs (kg)
T4A318GKF	1-1/2	18,000	11.8	20	25-3/16 x 23-1/8 x 23-1/8 (640 x 587 x 587)	143/117 (65/53)
T4A324GKF	2	24,000	17.6	25	28-11/16 x 31-3/16 x 31-3/16 (729 x 793 x 793)	213/176 (97/80)
T4A330GKF	2-1/2	30,000	16.8	25	32-1/8 x 31-3/16 x 31-3/16 (816 x 793 x 793)	199/165 (90/75)
T4A336GKN	3	36,000	21.9	35	25-3/16 x 31-3/16 x 31-3/16 (640 x 793 x 793)	196/160 (89/73)
T4A342GKN	3-1/2	42,000	23.5	40	32-1/8 x 31-3/16 x 31-3/16 (816 x 793 x 793)	230/195 (104/89)
T4A348GKN	4	48,000	26.0	40	35-1/2 x 31-3/16 x 31-3/16 (902 x 793 x 793)	243/203 (110/92)
T4A360GKN	5	60,000	34.2	50	28-11/16 x 31-3/16 x 31-3/16 (729 x 793 x 793)	250/215 (113/98)



# N4A7

## Efficient up to 17.0 SEER/12.0-12.5 EER Air Conditioner Environmentally Balanced R-410A Refrigerant

2 – 5 Tons Split System  
208 / 230 Volt, Single-Phase, 60 Hz

### Refrigeration Circuit

- Two-stage scroll compressors on all models
- Filter drier supplied with every unit for field installation
- Copper tube/aluminum fin coil

### Built to Last

- Baked-on powder coat finish over galvanized steel
- Post-painted (black) coil fins
- Coated, weather-resistant cabinet screws
- Coated inlet grille with 3/8" (10mm) spacing for extra protection (hail guard)

### Easy-to-Install and Service

- Easy access service valves on all models
- External high- and low-refrigerant service ports
- Only two screws to access control panel
- Factory charged with R-410A refrigerant
- Ion™ system control compatible with communicating relay module (see SYST0101CW Product Specification for details)

### Warranty\*

- Five-year parts limited warranty (including compressor and coil)
  - With timely registration, an additional five-year parts limited warranty (including compressor and coil)

\* For residential applications only. See warranty certificate for complete details and restrictions, including warranty coverage for other applications.



Qualifying models only.

### Unit Performance Data

Model Number	Size (tons)	Nominal Btu/hr	Min. Circuit Ampacity	Max. Fuse or Breaker	Operating Dimensions H x W x D (sq) in (mm)	Ship/Operating Weight lbs (kg)
N4A724GKA	2	24,000	14.5	25	32-1/2 x 31-3/16 x 31-3/16 (901 x 792 x 792)	206/167 (93/76)
N4A736GKA	3	36,000	19.8	30	32-1/2 x 31-3/16 x 31-3/16 (901 x 792 x 792)	230/191 (104/87)
N4A748GKA	4	48,000	27.8	40	38-7/8 x 35 x 35 (988 x 889 x 889)	295/253 (134/115)
N4A760GKA	5	60,000	37.3	60	38-7/8 x 35 x 35 (988 x 889 x 889)	299/258 (136/117)

# NXA6

## High-Efficiency up to 16.0 SEER Air Conditioner Environmentally Balanced R-410A Refrigerant

1-1/2 – 5 Tons Split System  
208 / 230 Volt, Single-Phase, 60 Hz



### Refrigeration Circuit

- Scroll compressors on all models
- Filter drier supplied with every unit for field installation
- Copper tube/aluminum fin coil
- 48 and 60 models for higher SEER, lower capacity
- Model size 49 for higher capacity, lower SEER

### Easy-to-Install and Service

- Easy access service valves on all models
- External high- and low-refrigerant service ports
- Only two screws to access control panel
- Factory charged with R-410A refrigerant
- Ion™ system control compatible with communicating relay module (see SYST0101CW Product Specification for details)

### Built to Last

- Baked-on powder coat finish over galvanized steel
- Post-painted (black) coil fins
- Coated, weather-resistant cabinet screws
- Coated inlet grille with 3/8" (10mm) spacing for extra protection (hail guard)

### Warranty\*

- Five-year parts limited warranty (including compressor and coil)
  - With timely registration, an additional five-year parts limited warranty (including compressor and coil)

\* For residential applications only. See warranty certificate for complete details and restrictions, including warranty coverage for other applications.



### Unit Performance Data

Model Number	Size (tons)	Nominal Btu/hr	Min. Circuit Ampacity	Max. Fuse or Breaker	Operating Dimensions H x W x D (sq) in (mm)	Ship/Operating Weight lbs (kg)
NXA618GKA	1-1/2	18,000	11.8	20	28-11/16 x 25-3/4 x 25-3/4 (729 x 654 x 654)	154/125 (70/57)
NXA624GKA	2	24,000	17.7	30	28-5/16 x 31-3/16 x 31-3/16 (719 x 792 x 792)	183/147 (85/67)
NXA630GKA	2-1/2	30,000	16.8	25	32-5/16 x 31-3/16 x 31-3/16 (821 x 792 x 792)	188/153 (85/69)
NXA636GKB	3	36,000	18.1	30	28-5/16 x 35 x 35 (719 x 889 x 889)	204/165 (93/75)
NXA642GKA	3-1/2	42,000	23.6	40	39-1/8 x 35 x 35 (994 x 889 x 889)	254/213 (115/96)
NXA648GKA	4	48,000	26.1	40	39-1/8 x 35 x 35 (994 x 889 x 889)	317/264 (144/120)
NXA649GKA	4	48,000	38.4	40	39-1/8 x 35 x 35 (994 x 889 x 889)	269/231 (122/105)
NXA660GKB	5	60,000	28.0	40	45-11/16 x 35 x 35 (1167 x 889 x 889)	318/280 (144/127)





# N4A6

## Efficient up to 17.0 SEER/11.7-13.0 EER Air Conditioner Environmentally Balanced R-410A Refrigerant

1-1/2 – 5 Tons Split System  
208 / 230 Volt, Single-Phase, 60 Hz

### Refrigeration Circuit

- Scroll compressors on all models
- Filter drier supplied with every unit for field installation
- Copper tube/aluminum fin coil

### Easy-to-Install and Service

- Easy access service valves on all models
- External high- and low-refrigerant service ports
- Only two screws to access control panel
- Factory charged with R-410A refrigerant
- Ion™ system control compatible with communicating relay module (see SYST0101CW Product Specification for details)

### Built to Last

- Baked-on powder coat finish over galvanized steel
- Post-painted (black) coil fins
- Coated, weather-resistant cabinet screws
- Coated inlet grille with 3/8" (10mm) spacing for extra protection (hail guard)

### Warranty\*

- Five-year parts limited warranty (including compressor and coil)
  - With timely registration, an additional five-year parts limited warranty (including compressor and coil)

\* For residential applications only. See warranty certificate for complete details and restrictions, including warranty coverage for other applications.



### Unit Performance Data

Model Number	Size (tons)	Nominal Btu/hr	Min. Circuit Ampacity	Max. Fuse or Breaker	Operating Dimensions H x W x D (sq) in (mm)	Ship/Operating Weight lbs (kg)
N4A618GKB	1-1/2	18,000	11.7	20	25-3/4 x 25-3/4 x 35-1/2 (654 x 654 x 901)	154/130 (70/59)
N4A624GKB	2	24,000	14.1	25	31-3/16 x 31-3/16 x 35-1/2 (793 x 793 x 901)	175/144 (79/65)
N4A630GKB	2-1/2	30,000	14.1	25	35 x 35 x 28-11/16 (889 x 889 x 729)	208/178 (94/81)
N4A636GKB	3	36,000	17.9	30	35 x 35 x 28-11/16 (889 x 889 x 729)	213/180 (97/82)
N4A642GKB	3-1/2	42,000	21.4	35	35 x 35 x 38-7/8 (889 x 889 x 988)	261/224 (118/102)
N4A648GKB	4	48,000	25.9	40	35 x 35 x 45-11/16 (889 x 889 x 1161)	284/247 (129/112)
N4A660GKB	5	60,000	32.4	40	35 x 35 x 45-11/16 (889 x 889 x 1161)	289/252 (131/114)

# NXA4

## Efficient 14.0 SEER Air Conditioner Environmentally Balanced R-410A Refrigerant

1-1/2 – 5 Tons Split System  
208 / 230 Volt, Single-Phase, 60 Hz



### Refrigeration Circuit

- Scroll compressors on all models
- Filter drier supplied with every unit for field installation
- Copper tube/aluminum fin coil

### Easy-to-Install and Service

- Easy access service valves on all models
- External high- and low-refrigerant service ports
- Only two screws to access control panel
- Factory charged with R-410A refrigerant
- Ion™ system control compatible with communicating relay module (see SYST0101CW Product Specification for details)

### Built to Last

- Baked-on powder coat finish over galvanized steel
- Post-painted (black) coil fins
- Coated, weather-resistant cabinet screws
- Available with 3/8" (10mm) spacing for extra protection (hail guard)

### Warranty\*

- Five-year parts limited warranty (including compressor and coil)
  - With timely registration, an additional five-year parts limited warranty (including compressor and coil)

\* For residential applications only. See warranty certificate for complete details and restrictions, including warranty coverage for other applications.

### Unit Performance Data

Model Number	Size (tons)	Nominal Btu/hr	Min. Circuit Ampacity	Max. Fuse or Breaker	Operating Dimensions H x W x D (sq) in (mm)	Ship/Operating Weight lbs (kg)
NXA418GKC	1-1/2	18,000	11.7	20	24-13/16 x 23-1/8 x 23-1/8 (630 x 587 x 587)	134/123 (61/56)
NXA424GKC	2	24,000	14.1	20	25 x 25-3/4 x 25-3/4 (635 x 654 x 654)	140/119 (84/54)
NXA430GKC	2-1/2	30,000	16.8	25	31-13/16 x 31-3/16 x 31-3/16 (808 x 792 x 792)	186/151 (84/68)
NXA436GKC	3	36,000	18.7	30	24-13/16 x 31-3/16 x 31-3/16 (630 x 792 x 792)	151/134 (87/68)
NXA442GKC	3-1/2	42,000	22.3	35	39-1/8 x 31-3/16 x 31-3/16 (994 x 792 x 792)	232/192 (105/87)
NXA448GKC	4	48,000	20.9	35	28-7/16 x 31-3/16 x 31-3/16 (722 x 792 x 792)	200/182 (91/82)
NXA460GKC	5	60,000	27.5	40	31-13/16 x 31-3/16 x 31-3/16 (808 x 792 x 792)	218/197 (99/89)



# N4A5

## Efficient 14.0 SEER/11.7-12.2 EER Air Conditioner Environmentally Balanced R-410A Refrigerant

1-1/2 – 5 Tons Split System  
208 / 230 Volt, Single-Phase, 60 Hz

### Refrigeration Circuit

- Scroll compressors on all models
- Copper tube/aluminum fin coil

### Easy-to-Install and Service

- Easy access service valves on all models
- External high- and low-refrigerant service ports
- Only two screws to access control panel
- Factory charged with R-410A refrigerant
- Ion™ system control compatible with communicating relay module (see SYST0101CW Product Specification for details)

### Built to Last

- Baked-on powder coat finish over galvanized steel
- Post-painted (black) coil fins
- Coated, weather-resistant cabinet screws
- Coated inlet grille with 3/8" (10mm) spacing for extra protection (hail guard)

### Warranty\*

- Five-year parts limited warranty (including compressor and coil)
  - With timely registration, an additional five-year parts limited warranty (including compressor and coil)

\* For residential applications only. See warranty certificate for complete details and restrictions, including warranty coverage for other applications.

### Unit Performance Data

Model Number	Size (tons)	Nominal Btu/hr	Min. Circuit Ampacity	Max. Fuse or Breaker	Operating Dimensions H x W x D (sq) in (mm)	Ship/Operating Weight lbs (kg)
N4A518GKC	1-1/2	18,000	11.7	20	25 x 25-3/4 x 25-3/4 (635 x 654 x 654)	145/122 (66/55)
N4A524GKC	2	24,000	14.1	20	32-5/16 x 25-3/4 x 25-3/4 (821 x 654 x 654)	148/123 (67/56)
N4A530GKC	2-1/2	30,000	16.8	25	31-13/16 x 31-3/16 x 31-3/16 (808 x 792 x 792)	186/151 (84/69)
N4A536GKC	3	36,000	18.1	30	35-3/16 x 31-3/16 x 31-3/16 (894 x 792 x 792)	171/151 (78/69)
N4A542GKC	3-1/2	42,000	22.3	35	31-3/16 x 28-7/16 x 28-7/16 (792 x 722 x 722)	226/191 (103/87)
N4A548GKC	4	48,000	20.9	35	28-7/16 x 31-3/16 x 31-3/16 (722 x 792 x 792)	200/182 (91/83)
N4A560GKC	5	60,000	27.5	40	31-13/16 x 31-3/16 x 31-3/16 (808 x 792 x 792)	218/197 (99/89)

# N4A4-C

## Coastal 14.0 SEER Air Conditioner R-410A Refrigerant

1-1/2 – 5 Tons Split System  
208 / 230 Volt, Single-Phase, 60 Hz



### Refrigeration Circuit

- Scroll compressors on all models
- Filter drier supplied with every unit for field installation
- Copper tube/aluminum fin coil

### Easy-to-Install and Service

- Easy access service valves on all models
- External high- and low-refrigerant service ports
- Only two screws to access control panel
- Factory charged with R-410A refrigerant
- Ion™ system control compatible with communicating relay module (see SYST0101CW Product Specification for details)

### Built to Last

- Baked-on powder coat finish on all sides
- Corrosion protection epoxy phenolic coated aluminum fins
- Coated, weather-resistant cabinet screws
- Coastal coated inlet grille with 3/8" (10mm) grill spacing for extra protection

### Warranty\*

- Five-year parts limited warranty (including compressor and coil)
  - With timely registration, an additional five-year parts limited warranty (including compressor and coil)

\* For residential applications only. See warranty certificate for complete details and restrictions, including warranty coverage for other applications.

### Unit Performance Data

Model Number	Size (tons)	Nominal Btu/hr	Min. Circuit Ampacity	Max. Fuse or Breaker	Operating Dimensions H x W x D (sq) in (mm)	Ship/Operating Weight lbs (kg)
N4A418CKA	1-1/2	18,000	11.7	20	28-7/16 x 23-1/8 x 23-1/8 (722 x 587 x 587)	133/111 (60/50)
N4A424CKA	2	24,000	14.1	25	28-7/16 x 31-3/16 x 31-3/16 (722 x 792 x 792)	170/136 (77/62)
N4A430CKA	2-1/2	30,000	16.8	25	24-13/16 x 31-3/16 x 31-3/16 (630 x 792 x 792)	183/152 (83/69)
N4A436CKA	3	36,000	17.8	30	24-13/16 x 31-3/16 x 31-3/16 (630 x 792 x 792)	185/155 (84/70)
N4A442CKA	3-1/2	42,000	22.3	35	28-7/16 x 31-3/16 x 31-3/16 (722 x 792 x 792)	220/189 (100/86)
N4A448CKA	4	48,000	24.5	40	35-3/4 x 31-3/16 x 31-3/16 (908 x 792 x 792)	233/233 (106/90)
N4A460CKA	5	60,000	31.7	50	39-1/8 x 35 x 35 (993 x 889 x 889)	289/248 (131/113)



# NH4A4

## 14.0 SEER Horizontal Discharge Air Conditioner For Use with Ducted Indoor Units Environmentally Balanced R-410A Refrigerant 1-1/2 – 5 Tons Split System, 208 / 230 Volt, Single-Phase

### Refrigeration Circuit

- 14.0 SEER/11.7 - 12.2 EER
- Scroll compressors on all models
- Factory supplied filter drier
- High-pressure switch
- Line lengths up to 250 feet (76.2m)

### Easy-to-Install and Service

- Small footprint
- Easy access service valves on all models
- Factory charged with R-410A refrigerant
- Ion™ system control compatible with communicating relay module (see SYST0101CW Product Specification for details)

### Built to Last

- Low-ambient operation (down to 0°F/-17.8°C)
- Ball bearing fan motor

### Warranty\*

- Five-year parts limited warranty (including compressor and coil)
  - With timely registration, an additional five-year parts limited warranty (including compressor and coil)

\* For residential applications only.  
See warranty certificate for complete details and restrictions, including warranty coverage for other applications.

### Unit Performance Data

Model Number	Size (tons)	Nominal Btu/hr	Min. Circuit Ampacity	Max. Fuse or Breaker	Operating Dimensions H x W x D (sq) in (mm)	Ship/Operating Weight lbs (kg)
<b>208/230-1-60</b>						
NH4A418AKA	1-1/2	18,000	11.8	20	31-1/8 x 36-15/16 x 14-9/16 (790 x 938 x 370)	166/146 (75/66)
NH4A424AKA	2	24,000	14.1	25	31-1/8 x 36-15/16 x 14-9/16 (790 x 938 x 370)	168/148 (76/67)
NH4A430AKA	2-1/2	30,000	18.3	30	37-1/8 x 44-1/2 x 17-1/16 (943 x 1130 x 433)	213/183 (97/83)
NH4A436AKA	3	36,000	18.8	30	37-1/8 x 44-1/2 x 17-1/16 (943 x 1130 x 433)	214/184 (97/84)
NH4A448AKA	4	48,000	24.3	40	37-1/8 x 44-1/2 x 17-1/16 (943 x 1130 x 433)	243/213 (110/97)
NH4A460AKA	5	60,000	31.1	50	43-1/8 x 44-1/2 x 17-1/16 (1095 x 1130 x 433)	275/245 (125/111)

# N4A3

## Efficient 13.0 SEER Air Conditioner Environmentally Balanced R-410A Refrigerant

2 – 5 Tons Split System  
208 / 230 Volt, Single-Phase, 60 Hz



### Refrigeration Circuit

- Scroll compressors on all models
- Filter drier supplied with every unit for field installation
- Copper tube/aluminum fin coil

### Easy-to-Install and Service

- Easy access service valves on all models
- External high- and low-refrigerant service ports
- Only two screws to access control panel
- Factory charged with R-410A refrigerant
- Ion™ system control compatible with communicating relay module (see SYST0101CW Product Specification for details)

### Built to Last

- Baked-on powder coat finish over galvanized steel
- Post-painted (black) coil fins
- Coated, weather-resistant cabinet screws
- Coated inlet grille with 2" (51mm) spacing standard, alternate models available with 3/8" (10mm) spacing for extra protection (hail guard)

### Warranty\*

- Five-year compressor limited warranty
- Five-year parts limited warranty (including compressor and coil)
  - With timely registration, an additional five-year parts limited warranty (including compressor and coil)

\* For residential applications only.  
See warranty certificate for complete details and restrictions, including warranty coverage for other applications.

### Unit Performance Data

Model Number	Size (tons)	Nominal Btu/hr	Min. Circuit Ampacity	Max. Fuse or Breaker	Operating Dimensions H x W x D (sq) in (mm)	Ship/Operating Weight lbs (kg)
N4A318AKF	1-1/2	18,000	11.8	20	25-5/16 x 23-1/8 x 23-1/8 (643 x 587 x 587)	130/107 (59/49)
N4A318GKF	1-1/2	18,000	11.8	20		
N4A324AKG	2	24,000	14.3	25	25-5/16 x 23-1/8 x 23-1/8 (643 x 587 x 587)	127/107 (58/49)
N4A324GKG	2	24,000	14.3	25		
N4A330AKG	2-1/2	30,000	16.6	25	28-11/16 x 25-3/4 x 25-3/4 (729 x 654 x 654)	149/126 (68/57)
N4A330GKG	2-1/2	30,000	16.6	25		
N4A336AKF	3	36,000	18.1	30	25-5/16 x 31-3/16 x 31-3/16 (642 x 792 x 792)	151/134 (68/61)
N4A336GKF	3	36,000	18.1	30		
N4A342AKN	3-1/2	42,000	23.5	40	32-5/16 x 31-3/16 x 31-3/16 (821 x 792 x 792)	218/190 (99/86)
N4A342GKN	3-1/2	42,000	23.5	40		
N4A348AKG	4	48,000	24.3	40	35-1/2 x 31-3/16 x 31-3/16 (901 x 792 x 792)	205/175 (93/79)
N4A348GKG	4	48,000	24.3	40		
N4A360AKN	5	60,000	29.0	50	28-11/16 x 31-3/16 x 31-3/16 (729 x 792 x 792)	232/199 (106/91)
N4A360GKN	5	60,000	29.0	50		

A = 2" (51 mm) spacing inlet grille  
G = 3/8" (10 mm) spacing inlet grille



# R4A5

## Efficient 14.0 SEER/11.7 -12.2 EER Air Conditioner Environmentally Balanced R-410A Refrigerant

1-1/2 – 5 Tons Split System  
208 / 230 Volt, Single-Phase 60 Hz

### Refrigeration Circuit

- Scroll compressors on all models
- Copper tube/aluminum fin coil

### Easy-to-Install and Service

- Easy access service valves on all models
- External high- and low-refrigerant service ports
- Only two screws to access control panel
- Factory charged with R-410A refrigerant
- Ion™ system control compatible with communicating relay module (see SYST0101CW Product Specification for details)

### Built to Last

- Pre-painted cabinet finish over galvanized steel
- Coated inlet grille with 2" (51mm) spacing or 3/8" (10mm) spacing for extra protection

### Warranty\*

- Five-year parts limited warranty (including compressor and coil)
  - With timely registration, an additional five-year parts limited warranty (including compressor and coil)

\* For residential applications only. See warranty certificate for complete details and restrictions, including warranty coverage for other applications.

### Unit Performance Data

Model Number	Size (tons)	Nominal Btu/hr	Min. Circuit Ampacity	Max. Fuse or Breaker	Operating Dimensions H x W x D (sq) in (mm)	Ship/Operating Weight lbs (kg)
R4A518*KB	1-1/2	18,000	11.7	20	25-5/16 x 25-3/4 x 25-3/4 (642 x 654 x 654)	145/122 (66/55)
R4A524*KB	2	24,000	14.1	20	32-1/16 x 25-3/4 x 25-3/4 (815 x 654 x 654)	148/123 (67/56)
R4A530*KB	2-1/2	30,000	16.8	25	31-11/16 x 31-3/16 x 31-3/16 (804 x 792 x 792)	186/151 (84/69)
R4A536*KB	3	36,000	18.1	30	35-1/16 x 31-3/16 x 31-3/16 (891 x 792 x 792)	171/151 (78/69)
R4A542*KB	3-1/2	42,000	22.3	35	28-1/4 x 31-3/16 x 31-3/16 (718 x 792 x 792)	226/191 (103/87)
R4A548*KB	4	48,000	20.9	35	28-1/4 x 31-3/16 x 31-3/16 (718 x 792 x 792)	200/182 (91/83)
R4A560*KB	5	60,000	27.5	40	31-11/16 x 31-3/16 x 31-3/16 (804 x 792 x 792)	218/197 (99/89)

\* A= 2" (51 mm) spacing inlet grille  
G = 3/8" (10 mm) spacing inlet grille

# R4A4

## Efficient 14.0 SEER Air Conditioner Environmentally Balanced R-410A Refrigerant

1-1/2 – 5 Tons Split System  
208 / 230 Volt, Single-Phase, 60 Hz



### Refrigeration Circuit

- Scroll compressors on all models
- Filter drier supplied with every unit for field installation
- Copper tube/aluminum fin coil

### Easy-to-Install and Service

- Easy access service valves on all models
- External high- and low-refrigerant service ports
- Only two screws to access control panel
- Factory charged with R-410A refrigerant
- Ion™ system control compatible with communicating relay module (see SYST0101CW Product Specification for details)

### Built to Last

- Pre-painted cabinet finish over galvanized steel
- Coated inlet grille with 2" (51mm) spacing or 3/8" (10mm) spacing for extra protection

### Warranty\*

- Five-year parts limited warranty (including compressor and coil)
  - With timely registration, an additional five-year parts limited warranty (including compressor and coil)

\* For residential applications only. See warranty certificate for complete details and restrictions, including warranty coverage for other applications.

### Unit Performance Data

Model Number	Size (tons)	Nominal Btu/hr	Min. Circuit Ampacity	Max. Fuse or Breaker	Operating Dimensions H x W x D (sq) in (mm)	Ship/Operating Weight lbs (kg)
R4A418AKB	1-1/2	18,000	11.7	20	23-7/8 x 23-1/8 x 23-1/8 (632 x 587 x 587)	134/123 (61/56)
R4A418GKB						
R4A424AKB	2	24,000	14.1	20	25-5/16 x 25-3/4 x 25-3/4 (642 x 654 x 654)	140/119 (84/54)
R4A424GKB						
R4A430AKB	2-1/2	30,000	16.8	25	31-11/16 x 31-3/16 x 31-3/16 (804 x 792 x 792)	186/151 (84/68)
R4A430GKB						
R4A436AKB	3	36,000	18.1	30	24-7/8 x 31-3/16 x 31-3/16 (632 x 792 x 792)	151/134 (87/87)
R4A436GKB						
R4A442AKB	3-1/2	42,000	22.3	35	38-7/16 x 31-3/16 x 31-3/16 (977 x 792 x 792)	232/192 (105/87)
R4A442GKB						
R4A448AKB	4	48,000	20.8	35	28-1/4 x 31-3/16 x 31-3/16 (718 x 792 x 792)	200/182 (91/82)
R4A448GKB						
R4A460AKB	5	60,000	27.5	40	31-11/16 x 31-3/16 x 31-3/16 (804 x 792 x 792)	218/197 (99/89)
R4A460GKB						

A = 2" (51 mm) spacing inlet grille  
G = 3/8" (10 mm) spacing inlet grille





# R4A3

## Efficient 13.0 SEER Air Conditioner Environmentally Balanced R-410A Refrigerant

**2 – 5 Tons Split System**  
**208 / 230 Volt, Single-Phase, 60 Hz**

### Refrigeration Circuit

- Scroll compressors on all models
- Copper tube/aluminum fin coil

### Warranty\*

- Five-year parts limited warranty (including compressor and coil)
  - With timely registration, an additional five-year parts limited warranty (including compressor and coil)

\* For residential applications only.  
See warranty certificate for complete details and restrictions, including warranty coverage for other applications.

### Built to Last

- Pre-painted cabinet finish over galvanized steel
- Coated inlet grille with 2" (51mm) spacing or 3/8" (10mm) spacing for extra protection

### Easy-to-Install and Service

- Easy access service valves on all models
- External high- and low-refrigerant service ports
- Only two screws to access control panel
- Factory charged with R-410A refrigerant
- Ion™ system control compatible with communicating relay module (see SYST0101CW Product Specification for details)

### Unit Performance Data

Model Number	Size (tons)	Nominal Btu/hr	Min. Circuit Ampacity	Max. Fuse or Breaker	Operating Dimensions H x W x D (sq) in (mm)	Ship/Operating Weight lbs (kg)
R4A318AKH	1-1/2	18,000	11.8	20	24-7/8 x 23-1/8 x 23-1/8 (630 x 587 x 587)	124/108 (56/49)
R4A318GKH	1-1/2	18,000	11.8	20	24-7/8 x 23-1/8 x 23-1/8 (630 x 587 x 587)	124/108 (56/49)
R4A324AKH	2	24,000	14.3	25	24-7/8 x 23-1/8 x 23-1/8 (630 x 587 x 587)	127/107 (58/49)
R4A324GKH	2	24,000	14.3	25	24-7/8 x 23-1/8 x 23-1/8 (630 x 587 x 587)	127/107 (58/49)
R4A330AKH	2-1/2	30,000	16.6	25	28-11/16 x 25-3/4 x 25-3/4 (729 x 654 x 654)	149/126 (68/57)
R4A330GKH	2-1/2	30,000	16.6	25	28-11/16 x 25-3/4 x 25-3/4 (729 x 654 x 654)	149/126 (68/57)
R4A336AKH	3	36,000	18.1	30	24-7/8 x 31-3/16 x 31-3/16 (630 x 792 x 792)	151/134 (68/61)
R4A336GKH	3	36,000	18.1	30	24-7/8 x 31-3/16 x 31-3/16 (630 x 792 x 792)	151/134 (68/61)
R4A342AKH	3-1/2	42,000	23.5	40	31-11/16 x 31-3/16 x 31-3/16 (804 x 792 x 792)	186/172 (85/78)
R4A342GKH	3-1/2	42,000	23.5	40	31-11/16 x 31-3/16 x 31-3/16 (804 x 792 x 792)	186/172 (85/78)
R4A348AKH	4	48,000	24.3	40	35-1/16 x 31-3/16 x 31-3/16 (891 x 792 x 792)	205/175 (93/79)
R4A348GKH	4	48,000	24.3	40	35-1/16 x 31-3/16 x 31-3/16 (891 x 792 x 792)	205/175 (93/79)
R4A360AKH	5	60,000	34.4	50	28-1/4 x 31-3/16 x 31-3/16 (718 x 792 x 792)	218/203 (99/92)
R4A360GKH	5	60,000	34.4	50	28-1/4 x 31-3/16 x 31-3/16 (718 x 792 x 792)	218/203 (99/92)

A = 2" (51 mm) spacing inlet grille  
G = 3/8" (10 mm) spacing inlet grille

# Accessories

## Residential Air Conditioners

TSA6, TSA5, T4A3, NXA4, NXA6, N4A3, N4A4, N4A5, N4A6, R4A5, R4A4, R4A3 (R-410A Air Conditioner)			
Part Number	Description	Used on Model Size	
NASA001CH	Crankcase Heater for Scroll Compressor (208/230 V)	T4A3	42, 48, 60
		TSA5	42
		TSA6	42, 48, 60
		N4A3	36, 42, 48, 60
		N4A4	42, 48
		N4A5	42, 48, 60
		N4A6	42, 48, 60
		NXA4	42, 48, 60
		NXA6	42, 48, 49, 60, 61
		R4A5	42, 48, 60
		R4A4	42, 48, 60
		R4A3	36, 42, 48, 60
NASA003CH	Crankcase Heater for Scroll Compressor (208/230 V) (factory installed on some models)	T4A3	18, 24, 30, 36
		TSA6	18, 24, 30, 36
		TSA5	24, 30, 36
		N4A5	24, 30, 36
		N4A3	ALL
		T4A3	ALL
		N4A4	18, 24, 30, 36
		N4A6	18, 24, 30, 36
		NXA4	18, 24, 30, 36
		NXA6	18, 24, 30, 36
		R4A4	18, 24, 30
		R4A5	18, 24, 30, 36
NASA00501CH	Crankcase Heater for Scroll Compressor (208/230 V)	TSA5	48, 60
NASA003SC	Hard Start Kit	T4A3	ALL
		N4A3	ALL
		N4A4	42
		R4A3	ALL
NASA005SC	Hard Start Kit	N4A5	ALL
		N4A4	18, 24, 36, 48, 60
NASA014SC	Hard Start Kit	TSA6	ALL
		TSA5	ALL
TSTAT0201CW	Observer® Self-Configuring Communication Wall Control Ion™ Communicating System Control	TSA6	ALL
SYST0101CW		TSA5	ALL
NASA001SJ	Sound Jacket, Compressor (factory installed on some models)	N4A3	18, 24, 30, 36, 42, 48
		N4A4	18, 24, 30, 36, 42, 48
		N4A6	18, 24, 30, 36, 42, 48
		N4A5	18, 24, 30, 36, 42, 48
		NXA4	42, 48
		NXA6	18, 24, 30, 36, 42, 48, 49
		R4A3	18, 24, 30, 36, 42, 48
		R4A4	42, 48
R4A5	18, 24, 30, 36, 42, 48		

# Accessories

## Residential Air Conditioners

TSA6, TSA5, T4A3, NXA4, NXA6, N4A3, N4A4, N4A5, N4A6, R4A5, R4A4, R4A3 (R-410A Air Conditioner)			
Part Number	Description	Used on Model Size	
NASA003SJ	Sound Jacket, Compressor (factory installed on some models)	N4A3	60
		N4A4	60
		N4A6	60
		N4A5	60
		NXA4	60
		NXA6	60, 61
		R4A3	60
		R4A4	60
		R4A5	60
NASA002SJ	Sound Jacket, Compressor	NXA4	18, 24, 30
		R4A4	18, 24, 30
NAEA40501TX	TXV Kit, R-410A – for use with copper or tin fan coils	ALL	18, 24, 30
NAEA40601TX	TXV Kit, R-410A – for use with copper or tin fan coils	ALL	36, 42
NAEA40701TX	TXV Kit, R-410A – for use with copper or tin fan coils	ALL	48, 49, 60, 61
NAEB40501TX	TXV Kit, R-410A – for use with aluminum fan coils	ALL	18, 24, 30
NAEB40601TX	TXV Kit, R-410A – for use with aluminum fan coils	TSA5	36
		ALL	36, 42
NAEB40701TX	TXV Kit, R-410A – for use with aluminum fan coils	TSA5	42, 48, 60
		ALL	48, 49, 60, 61
NASA001SC	Start Component – PTC Deluxe	ALL	
NASA00201FS	Evaporator Freeze Thermostat	ALL	
NASA403PS	Low-Pressure Switch, AC, R-410A (factory installed on some models)	ALL	
NASA404PS	High-Pressure Switch, AC or HP, R-410A (factory installed on some models)	ALL	
NASA401LS	Liquid Line Solenoid Valve, R-410A	ALL	
NASA001TD	Time Delay Relay, Indoor Blower	ALL	
NASA00201WS	Winter Start Control	ALL	
NASA001WS	Winter Start Control	ALL	
NASA001AC	Anti-Cycle Timer (5-minute delay)	ALL	
NASA401LA	Low-Ambient Pressure Switch	ALL	
NASA001SF	Support Feet, 4" (102 mm) tall (4 blocks)	N4A3	42, 48, 60
		N4A4	24, 30, 42, 48, 60
		N4A6	30, 42, 48, 60
		N4A5	42, 48, 60
		T4A3	30, 42, 48, 60
		R4A5	42, 48, 60
		N4A3	30, 36
NASA00201SF	Support Feet, 4" (102 mm) tall (5 blocks)	N4A4	18
		N4A6	18, 30, 36
		N4A5	18, 30, 36
		NXA4	ALL
		TSA5	ALL
		T4A3	18, 24, 36
		R4A5	18, 24, 36
		R4A5	18, 24, 36

# Accessories Residential Air Conditioners

<b>N4A7 (Two-Stage Air Conditioner)</b>		
<b>Part Number</b>	<b>Description</b>	<b>Used on Model Size</b>
NASA00601CH	Crankhouse Heater for Scroll Compressor	24, 36
NASA001SC	Start Component - PTC Device	ALL
NASA00201FS	Evaporator Freeze Thermostat	ALL
NASA401LS	Liquid Line Solenoid Valve, R-410A	ALL
NASA001TD	Time Delay Relay, Indoor Blower	ALL
NASA00201WS	Winter Start Control	ALL
NASA001AC	Anti-Cycle Timer (5-minute delay)	ALL
NASA012SC	Hard Start Kit (capacitor and relay)	ALL
NASA401LA	Low-Ambient Kit (pressure switch), R-410A	ALL
NASA001SF	Support Feet, 4" (102 mm) tall	42
NASA00201SJ	Sound Jacket Compressor	24, 36
NASA00101SJ	Sound Jacket Compressor	48, 60
NAEA40501TX	TXV Kit, R-410A - for use with copper or tin fan coils	24
NAEA40601TX	TXV Kit, R-410A - for use with copper or tin fan coils	36
NAEA40701TX	TXV Kit, R-410A - for use with copper or tin fan coils	48, 60
NAEB40501TX	TXV Kit, R-410A - for use with aluminum fan coils	24
NAEB40601TX	TXV Kit, R-410A - for use with aluminum fan coils	36
NAEB40701TX	TXV Kit, R-410A - for use with aluminum fan coils	48, 60
<b>TCA724-60GKA2/B1 (R-410A Two-Stage Communicating Air Conditioner)</b>		
<b>Part Number</b>	<b>Description</b>	<b>Used on Model Size</b>
TSTAT0201CW	Observer® Self-Configuring Communicating Wall Control	ALL
SYST0101CW	Ion™ Communicating System Control	ALL
NASA401LS	Liquid Line Solenoid Valve, R-410A	ALL
NASA001TD	Time Delay Relay, Indoor Blower	ALL
NASA001SF	Support Feet, 4" (102 mm) tall (4 blocks)	
NASA00201SF	Support Feet, 4" (102 mm) tall (5 blocks)	ALL
NASA012SC	Hard Start Kit	24, 36
NASA013SC	Hard Start Kit	48, 60
NASA00201FS	Evaporator Freeze Thermostat	ALL
NASA00201WS	Winter Start Control	ALL
NASA401LA	Low-Ambient Pressure Kit	ALL
NASA01001CH	Crankcase Heater for Scroll Compressor (208/230 V) (factory installed on 48 and 60)	24, 36
<b>TVA9 (R-410A Five-Stage Communicating Air Conditioner)</b>		
<b>Part Number</b>	<b>Description</b>	<b>Used on Model Size</b>
SYST0201CW	Ion™ System Control	(see Ion product pages for additional Accessories)
TSTAT0201CW	Observer® Self-Configuring Communicating Wall Control	ALL
NASA00106SS	Snow Stand Kit	60
NASA001SF	Support Feet, 4" (102 mm) tall (4 blocks)	ALL
NASA00201SF	Support Feet, 4" (102 mm) tall (5 blocks)	ALL
NAEA40501TX	TXV Kit, R-410A for use on copper or tin fin coils	24, 25
NAEA40601TX	TXV Kit, R-410A for use on copper or tin fin coils	36, 37
NAEA40701TX	TXV Kit, R-410A for use on copper or tin fin coils	48, 49, 60
NAEB40501TX	TXV Kit, R-410A for use on aluminum fin coils	24, 25
NAEB40601TX	TXV Kit, R-410A for use on aluminum fin coils	36, 37
NAEB40701TX	TXV Kit, R-410A for use on aluminum fin coils	48, 49, 60
1187979	Vapor Line Muffler (FAST Parts)	ALL

Some accessories may be factory installed. Refer to product specifications for exact accessory match.

# Accessories

## Residential Ducted Horizontal Air Conditioner – NH4A4

Kit Number	Description	Unit Size (Voltage/Series)											
		18	24	30	36	36	36	48	48	48	60	60	60
		AKA	AKA	AKA	AKA	AHA	ALA	AKA	AHA	ALA	AKA	AHA	ALA
NASA003CH	Crankcase Heater	X	X	X	X	X							
NASA001CH	Crankcase Heater							X	X		X	X	
NASA004CH	Crankcase Heater						X						
NASA00301CH	Crankcase Heater									X			X
NASA00201FS	Evaporator Freeze Stat	X	X	X	X	X	X	X	X	X	X	X	X
NASA001TD	Time Delay Relay	X	X	X	X	X	X	X	X	X	X	X	X
NASA00201WS	Winter Start Control	X	X	X	X	X	X	X	X	X	X	X	X
NASA401LA	Low-Ambient Kit	X	X	X	X	X	X	X	X	X	X	X	X
NASA00201WB	Wind Baffle	X	X										
NASA00301WB	Wind Baffle			X	X	X	X	X	X	X			
NASA00401WB	Wind Baffle										X	X	X
NASA00101SG	Stacking Kit	X	X										
NASA00201SG	Stacking Kit			X	X	X	X	X	X	X	X	X	X
NASA00101WM	Wall Mounting Kit	X	X										
NASA00201WM	Wall Mounting Kit			X	X	X	X	X	X	X	X	X	X
NASA404PS	Low-Pressure Switch Kit	X	X	X	X	X	X	X	X	X	X	X	X
1177810	Sound Blanket Kit							X	X	X	X	X	X
NASA401LS	Solenoid Valve Kit	X	X	X	X	X	X	X	X	X	X	X	X
NASA003SC	Capacitor Relay Start Assist	X	X	X	X			X			X		



# Residential Heat Pumps

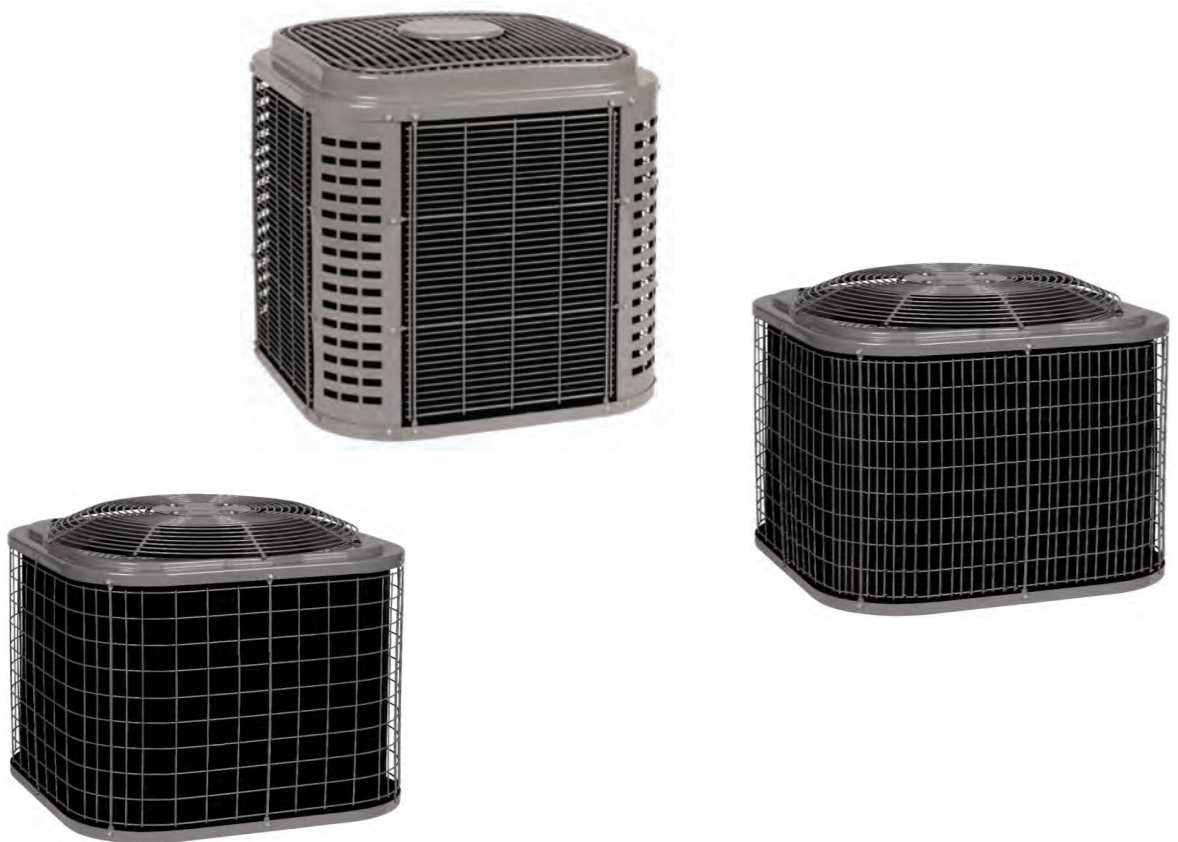

# TVH8

## High-Efficiency up to 19.0 SEER Variable-Speed Heat Pump

2 – 5 Tons Split System  
208 / 230 Volt, Single-Phase, 60 Hz



Recommended (Sold separately)



### Refrigeration Circuit

- Variable-speed compressor operates at five stages with capacity range as wide as 25 - 100%
- Electronic expansion valve (EXV) for precise heating control
- High-pressure switch
- Suction pressure transducer
- Pressure equalizer valve for easy starting
- Compressor discharge temperature sensor
- Coil temperature sensor
- Copper tube/aluminum fin coil
- Internal crankcase heater standard
- Suction line accumulator factory installed

### Built to Last

- High-gloss, baked-on powder coat finish over galvanized steel
- Post-painted (black) coil fins
- Coated inlet grille with 3/8" (10mm) spacing for extra protection (hail guard)
- Corner posts for extra strength and style

### Performance

- Up to 13.0 EER and 11.0 HSPF
- Integrated inverter control enables five-stage operation with Observer Communicating System or Ion™ System Control
- Also capable of two-stage operation with two-stage thermostat
- Self-configuring installation with Observer Communicating Wall Control
- Compact ECM fan motor driven by integrated inverter control
- Outdoor temperature sensor factory installed
- High performance compressor sound shield standard
- Isolation compressor grommets
- Enhanced dehumidification

### Warranty\*

- 10-year No Hassle Replacement™ limited warranty
- Five-year parts limited warranty (including compressor and coil)
  - With timely registration, an additional five-year parts limited warranty (including compressor and coil)

\* For residential applications only. See warranty certificate for complete details and restrictions, including warranty coverage for other applications.

### Easy-to-Install and Service

- Text based diagnostics with Observer/Ion Communicating Wall Control
- Only two control wires required from communicating indoor unit to condenser
- External high- and low-refrigerant service ports
- Factory charged with R-410A refrigerant
- Adjustments for min. and max. staging with Observer Communicating Wall Control



Qualifying models only.

### Unit Performance Data

Model Number	Size (tons)	Nominal Btu/hr	Min. Circuit Ampacity	Max. Fuse or Breaker	Operating Dimensions H x L x W (sq) in (mm)	Ship/Operating Weight lbs (kg)
TVH824GKA	2	24,000	13.5	20	31-13/16 x 23-1/8 x 23-1/8 (807 x 587 x 587)	154/132 (70/60)
TVH825GKA†	2	24,000	23.6	40	38-1/2 x 23-1/8 x 23-1/8 (980 x 587 x 587)	181/156 (82/71)
TVH836GKA	3	36,000	24.4	40	38-1/2 x 23-1/8 x 23-1/8 (980 x 587 x 587)	181/156 (82/71)
TVH837GKA†	3	36,000	26.0	40	38-15/16 x 31-3/16 x 31-3/16 (989 x 242 x 242)	244/207 (111/94)
TVH848GKA	4	48,000	31.4	50	38-15/16 x 31-3/16 x 31-3/16 (989 x 792 x 792)	244/207 (111/94)
TVH860GKA	5	60,000	40.8	60	42-5/16 x 31-3/16 x 31-3/16 (1075 x 792 x 792)	272/233 (123/106)

† Meets ENERGY STAR® criteria when matched with appropriate coil.





Recommended (Sold separately)

# TCH6

## High Efficiency up to 17.0 SEER Two-Stage Heat Pump with Observer®/Ion™ Communicating Control System

2 – 5 Tons Split System  
208 / 230 Volt, Single-Phase, 60 Hz

### Refrigeration Circuit

- Copeland Scroll™ UltraTech™ compressors on all models
- Crankcase heater factory installed
- Suction line accumulator factory installed
- Bi-flow filter drier supplied with every unit for field installation
- Integrated solid-state control with Time-Temperature Defrost
- High- and low-pressure switches
- Discharge gas thermostat
- Copper tube/aluminum fin coil

### Built to Last

- High-gloss, baked-on powder coat finish over galvanized steel
- Post-painted (black) coil fins
- Coated, weather-resistant cabinet screws
- Coated inlet grille with 3/8" (10mm) spacing for extra protection (hail guard)
- Corner posts for extra strength and style

### Performance

- Communicating, self-configuring operation when used with Observer/Ion Communicating Wall Control
- Outdoor temperature sensor factory installed
- Ball bearing PSC fan motors on all models
- High performance compressor sound shield standard
- Isolation compressor grommets

### Warranty\*

- 10-year No Hassle Replacement™ limited warranty
- Five-year parts limited warranty (including compressor and coil)
  - With timely registration, an additional five-year parts limited warranty (including compressor and coil)

\* For residential applications only. See warranty certificate for complete details and restrictions, including warranty coverage for other applications.

### Easy-to-Install and Service

- Text based diagnostics with Observer/Ion Communicating Wall Control
- Only two control wires required from communicating indoor unit to condenser
- Easy access service valves on all models
- Innovative control box design
- External high- and low-refrigerant service ports
- Only two screws to access control panel
- Factory charged with R-410A refrigerant



### Unit Performance Data

Model Number	Size (tons)	Nominal Btu/hr	Min. Circuit Ampacity	Max. Fuse or Breaker	Operating Dimensions H x W x D (sq) in (mm)	Ship/Operating Weight lbs (kg)
TCH624GKA1	2	24,000	16.4	25	40-1/8 x 35 x 35 (1019 x 889 x 889)	292/249 (132/113)
TCH624GKA3	2	24,000	16.2	25	40-1/8 x 35 x 35 (1019 x 889 x 889)	292/249 (132/113)
TCH636GKA1	3	36,000	21.8	35	43-1/2 x 35 x 35 (1105 x 889 x 889)	313/270 (142/123)
TCH636GKA2	3	36,000	23.7	40	40-1/8 x 35 x 35 (1019 x 889 x 889)	313/270 (142/123)
TCH648GKA1	4	48,000	34.8	50	46-7/8 x 35 x 35 (1191 x 889 x 889)	345/302 (157/137)
TCH648GKA2	4	48,000	29.8	50	40-1/8 x 35 x 35 (1019 x 889 x 889)	345/302 (157/137)
TCH660GKA1	5	60,000	30.1	50	46-7/8 x 35 x 35 (1191 x 889 x 889)	369/323 (167/147)
TCH660GKA2	5	60,000	37.5	60	46-7/8 x 35 x 35 (1191 x 889 x 889)	369/323 (167/147)

# TSH6

## 16.0 SEER Single-Stage Heat Pump with Observer®/Ion™ Communicating Control System

1-1/2 – 5 Tons Split System  
208 / 230 Volt, Single-Phase, 60 Hz



Recommended (Sold separately)



### Refrigeration Circuit

- Scroll compressors on all models
- Suction line accumulator factory installed
- Bi-flow filter drier supplied with every unit for field installation
- Integrated solid-state control with Time-Temperature Defrost
- External high- and low-refrigerant service ports
- Copper tube/aluminum fin coil

### Performance

- Communicating, self-configuring operation when used with Observer/Ion Communicating Wall Control
- Outdoor temperature sensor factory installed
- Compressor sound blanket standard
- Isolation compressor grommets

### Easy-to-Install and Service

- Text based diagnostics with Observer/Ion Communicating Wall Control
- Easy access service valves on all models
- Innovative control box design
- High- and low-pressure switches
- Only two screws to access control panel
- Factory charged with R-410A refrigerant

### Built to Last

- High-gloss, baked-on powder coat finish over galvanized steel
- Post-painted (black) coil fins
- Coated, weather-resistant cabinet screws
- Coated inlet grille with 3/8" (10mm) spacing for extra protection (hail guard)
- Corner posts for extra strength and style

### Warranty\*

- Five-year No Hassle Replacement™ limited warranty (when installed with Observer Wall Control)
- Five-year parts limited warranty (including compressor and coil)
  - With timely registration, an additional five-year parts limited warranty (including compressor and coil)

\* For residential applications only. See warranty certificate for complete details and restrictions, including warranty coverage for other applications.



### Unit Performance Data

Model Number	Size (tons)	Nominal Btu/hr	Min. Circuit Ampacity	Max. Fuse or Breaker	Operating Dimensions H x W x D (sq) in (mm)	Ship/Operating Weight lbs (kg)
TSH618GKA	1-1/2	18,000	13.6	20	31-3/16 x 31-3/16 x 35-1/2 (793 x 793 x 902)	213/181 (97/82)
TSH624GKA	2	24,000	15.5	25	35 x 35 x 33-5/8 (889 x 889 x 854)	232/194 (105/88)
TSH630GKA	2-1/2	30,000	19.9	30	35 x 35 x 33-5/8 (889 x 889 x 854)	267/229 (121/104)
TSH636GKA	3	36,000	21.6	35	35 x 35 x 33-5/8 (889 x 889 x 854)	275/237 (125/108)
TSH642GKA	3-1/2	42,000	27.8	40	35 x 35 x 33-5/8 (889 x 889 x 854)	293/255 (133/116)
TSH648GKA	4	48,000	31.8	45	35 x 35 x 33-5/8 (889 x 889 x 854)	298/260 (135/118)
TSH660GKA	5	60,000	33.9	50	35 x 35 x 47-3/16 (889 x 889 x 1199)	363/317 (165/144)



# TSH4

## 14.0 SEER Single-Stage Heat Pump with Observer®/Ion™ Communicating Control System

1-1/2 – 5 Tons Split System  
208 / 230 Volt, Single-Phase, 60 Hz



Recommended (Sold separately)

### Refrigeration Circuit

- Copeland Scroll™ UltraTech™ compressors on all models
- Suction line accumulator factory installed
- Bi-flow filter drier supplied with every unit for field installation
- Integrated solid-state control with Time-Temperature Defrost
- External high- and low-refrigerant service ports
- Copper tube/aluminum fin coil

### Built to Last

- High-gloss, baked-on powder coat finish over galvanized steel
- Post-painted (black) coil fins
- Coated, weather-resistant cabinet screws
- Coated inlet grille with 3/8" (10mm) spacing for extra protection (hail guard)
- Corner posts for extra strength and style

### Performance

- Communicating, self-configuring operation when used with Observer/Ion Communicating Wall Control
- Outdoor temperature sensor factory installed
- Compressor sound blanket standard
- Isolation compressor grommets

### Easy-to-Install and Service

- Text based diagnostics with Observer/Ion Communicating Wall Control
- Easy access service valves on all models
- Innovative control box design
- High- and low-pressure switches
- Only two screws to access control panel
- Factory charged with R-410A refrigerant

### Warranty\*

- Three-year No Hassle Replacement™ limited warranty
- Five-year parts limited warranty (including compressor and coil) – With timely registration, an additional five-year parts limited warranty (including compressor and coil)

\* For residential applications only. See warranty certificate for complete details and restrictions, including warranty coverage for other applications.



### Unit Performance Data

Model Number	Size (tons)	Nominal Btu/hr	Min. Circuit Ampacity	Max. Fuse or Breaker	Operating Dimensions H x W x D (sq) in (mm)	Ship/Operating Weight lbs (kg)
TSH418GKA	1-1/2	18,000	11.8	20	28-11/16 x 31-3/16 x 31-3/16 (729 x 793 x 793)	219/184 (99/84)
TSH424GKA	2	24,000	17.6	25	28-11/16 x 31-3/16 x 31-3/16 (729 x 793 x 793)	195/164 (89/73)
TSH430GKA	2-1/2	30,000	18.3	30	28-11/16 x 31-3/16 x 31-3/16 (729 x 793 x 793)	216/182 (98/83)
TSH436GKA	3	36,000	20.0	30	28-11/16 x 31-3/16 x 31-3/16 (729 x 793 x 793)	228/194 (103/88)
TSH442GKA	3-1/2	42,000	24.0	40	28-11/16 x 31-3/16 x 31-3/16 (729 x 793 x 793)	252/221 (114/100)
TSH448GKA	4	48,000	25.2	40	28-11/16 x 31-3/16 x 31-3/16 (729 x 793 x 793)	252/221 (114/100)
TSH460GKA	5	60,000	32.0	50	28-11/16 x 31-3/16 x 31-3/16 (729 x 793 x 793)	267/236 (121/107)

# N4H6

## Efficient Up to 17.5 SEER Heat Pump Environmentally Balanced R-410A Refrigerant

2 – 5 Tons Split System  
208 / 230 Volt, Single-Phase



### Refrigeration Circuit

- Two-stage scroll compressors on all models
- Suction line accumulator factory installed
- Bi-flow filter drier included for field installation
- Integrated solid state control with Time-Temperature Defrost
- High- and low-pressure switches
- Copper tube/aluminum fin coil

### Easy-to-Install and Service

- Easy access service valves on all models
- External high- and low-refrigerant service ports
- Only two screws to access control panel
- Factory charged with R-410A refrigerant
- Ion™ system control compatible with communicating relay module (see SYST0101CW Product Specification for details)

### Built to Last

- Baked-on powder coat finish over galvanized steel
- Post-painted (black) coil fins
- Coated, weather-resistant cabinet screws
- Coated inlet grille with 3/8" (10mm) spacing for extra protection

### Warranty\*

- Five-year compressor limited warranty (including compressor and coil)
  - With timely registration, an additional five-year parts limited warranty (including compressor and coil)

\* For residential applications only. See warranty certificate for complete details and restrictions, including warranty coverage for other applications.



Qualifying models only.

### Unit Performance Data

Model Number	Size (tons)	Nominal Btu/hr	Min. Circuit Ampacity	Max. Fuse or Breaker	Operating Dimensions H x W x D (sq) in (mm)	Ship/Operating Weight lbs (kg)
N4H624GKA	2	24,000	16.2	25	38-7/8 x 35 x 35 (988 x 889 x 889)	277/233 (126/106)
N4H636GKA	3	36,000	23.7	40	38-7/8 x 35 x 35 (988 x 889 x 889)	289/245 (131/111)
N4H648GKA	4	48,000	29.5	50	38-7/8 x 35 x 35 (988 x 889 x 889)	315/271 (143/123)
N4H660GKA	5	60,000	37.5	60	45-11/16 x 35 x 35 (1161 x 889 x 889)	340/294 (154/133)



# NXH6

## High-Efficiency 16.0 SEER Heat Pump Environmentally Balanced R-410A Refrigerant

1-1/2 – 5 Tons Split System  
208 / 230 Volt, Single-Phase, 60 Hz

### Refrigeration Circuit

- Scroll compressors on all models
- Suction line accumulator factory installed
- Bi-flow filter drier included for field installation
- Integrated solid-state control with Time-Temperature Defrost
- High- and low-pressure switches
- Copper tube/aluminum fin coil

### Easy-to-Install and Service

- Easy access service valves on all models
- External high- and low-refrigerant service ports
- Only two screws to access control panel
- Factory charged with R-410A refrigerant
- Ion™ system control compatible with communicating relay module (see SYST0101CW Product Specification for details)

### Built to Last

- Baked-on powder coat finish over galvanized steel
- Post-painted (black) coil fins
- Coated, weather-resistant cabinet screws
- Coated inlet grille with 3/8" (10mm) spacing for extra protection (hail guard)

### Warranty\*

- Five-year parts limited warranty (including compressor and coil)
  - With timely registration, an additional five-year parts limited warranty (including compressor and coil)

\* For residential applications only. See warranty certificate for complete details and restrictions, including warranty coverage for other applications.



### Unit Performance Data

Model Number	Size (tons)	Nominal Btu/hr	Min. Circuit Ampacity	Max. Fuse or Breaker	Operating Dimensions H x W x D (sq) in (mm)	Ship/Operating Weight lbs (kg)
NXH618GKA	1-1/2	18,000	13.6	20	35-1/2 x 31-3/16 x 31-3/16 (901 x 793 x 793)	199/167 (90/76)
NXH624GKA	2	24,000	15.5	25	32-1/16 x 35 x 35 (815 x 889 x 889)	210/172 (95/78)
NXH630GKA	2-1/2	30,000	19.9	30	32-1/16 x 35 x 35 (815 x 889 x 889)	245/207 (111/94)
NXH636GKA	3	36,000	21.6	35	32-1/16 x 35 x 35 (815 x 889 x 889)	253/215 (115/98)
NXH642GKA	3-1/2	42,000	27.8	40	32-1/16 x 35 x 35 (815 x 889 x 889)	271/233 (123/106)
NXH648GKA	4	48,000	31.8	45	32-1/16 x 35 x 35 (815 x 889 x 889)	276/238 (125/108)
NXH660GKA	5	60,000	33.9	50	45-11/16 x 35 x 35 (1161 x 889 x 889)	334/288 (152/131)

# NXH5

## High-Efficiency Up to 15.0 SEER Heat Pump Environmentally Balanced R-410A Refrigerant

1-1/2 – 5 Tons Split System  
208 / 230 Volt, Single-Phase, 60 Hz



### Refrigeration Circuit

- Scroll compressors on all models
- Suction line accumulator factory installed
- Bi-flow filter drier included for field installation
- Integrated solid-state control with Time-Temperature Defrost
- High- and low-pressure switches
- Copper tube/aluminum fin coil

### Easy-to-Install and Service

- Easy access service valves on all models
- External high- and low-refrigerant service ports
- Only two screws to access control panel
- Factory charged with R-410A refrigerant
- Ion™ system control compatible with communicating relay module (see SYST0101CW Product Specification for details)

### Built to Last

- Baked-on powder coat finish over galvanized steel
- Post-painted (black) coil fins
- Coated, weather-resistant cabinet screws
- Coated inlet grille with 3/8" (10mm) spacing for extra protection (hail guard)

### Warranty\*

- Five-year parts limited warranty (including compressor and coil)
  - With timely registration, an additional five-year parts limited warranty (including compressor and coil)

\* For residential applications only. See warranty certificate for complete details and restrictions, including warranty coverage for other applications.



### Unit Performance Data

Model Number	Size (tons)	Nominal Btu/hr	Min. Circuit Ampacity	Max. Fuse or Breaker	Operating Dimensions H x W x D (sq) in (mm)	Ship/Operating Weight lbs (kg)
NXH518GKA	1-1/2	18,000	11.8	20	28-15/16 x 31-3/16 x 31-3/16 (735 x 792 x 792)	207/169 (94/77)
NXH524GKA	2	24,000	16.5	25	32-5/16 x 35 x 35 (821 x 889 x 889)	233/200 (106/91)
NXH530GKA	2-1/2	30,000	18.1	30	32-5/16 x 35 x 35 (821 x 889 x 889)	242/196 (110/89)
NXH536GKA	3	36,000	22.1	35	35-3/4 x 35 x 35 (908 x 889 x 889)	257/215 (117/98)
NXH537GKB	3	36,000	22.1	35	35-3/4 x 35 x 35 (908 x 889 x 889)	297/255 (135/116)
NXH542GKA	3-1/2	42,000	27.6	40	28-15/16 x 35 x 35 (735 x 889 x 889)	290/245 (132/111)
NXH548GKB	4	48,000	31.8	45	32-1/16 x 35 x 35 (815.1 x 889 x 889)	345/294 (157/133)
NXH560GKA	5	60,000	34.2	50	39-1/8 x 35 x 35 (994 x 889 x 889)	345/294 (157/133)
NXH561GKA	5	60,000	33.8	50	45-11/16 x 35 x 35 (1161 x 889 x 889)	334/288 (152/131)



# N4H4

## Efficiency 14.0 SEER Heat Pump Environmentally Sound R-410A Refrigerant

1-1/2 – 5 Tons Split System  
208 / 230 Volt, Single-Phase, 60 Hz

### Refrigeration Circuit

- Scroll compressors on all models
- Suction line accumulator factory installed
- Integrated solid state control with Time-Temperature Defrost
- High- and low-pressure switches
- Copper tube/aluminum fin coil

### Easy-to-Install and Service

- Easy access service valves on all models
- External high- and low-refrigerant service ports
- Only two screws to access control panel
- Factory charged with R-410A refrigerant
- Ion™ system control compatible with communicating relay module (see SYST0101CW Product Specification for details)

### Built to Last

- Painted cabinet finish over galvanized steel
- Models available with coated inlet grille with 3/8" (10mm) spacing grille

### Warranty\*

- Five-year compressor limited warranty (including compressor and coil)
  - With timely registration, an additional five-year parts limited warranty (including compressor and coil)

\* For residential applications only. See warranty certificate for complete details and restrictions, including warranty coverage for other applications.

### Unit Performance Data

Model Number	Size (tons)	Nominal Btu/hr	Min. Circuit Ampacity	Max. Fuse or Breaker	Operating Dimensions H x W x D (sq) in (mm)	Ship/Operating Weight lbs (kg)
N4H418GKG	1-1/2	18,000	11.8	20	35-1/4 x 23-1/8 x 23-1/8 (899 x 587 x 587)	166/136 (75/61)
N4H424GKG	2	24,000	14.2	25	35-1/4 x 25-3/4 x 25-3/4 (895 x 654 x 654)	175/144 (79/65)
N4H430GKG	2-1/2	30,000	16.9	30	31-13/16 x 31-3/16 x 31-3/16 (808 x 792 x 792)	180/158 (82/72)
N4H436GKG	3	36,000	20.0	30	28-7/16 x 31-3/16 x 31-3/16 (722 x 792 x 792)	201/170 (91/77)
N4H442GKG	3-1/2	42,000	24.0	40	39-1/8 x 31-3/16 x 31-3/16 (994 x 792 x 792)	235/201 (107/91)
N4H448GKG	4	48,000	25.2	40	28-7/16 x 31-3/16 x 31-3/16 (722 x 792 x 792)	232/197 (105/89)
N4H460GKG	5	60,000	32.0	50	31-13/16 x 31-3/16 x 31-3/16 (808 x 792 x 792)	248/212 (113/96)

# N4H4-C

## Coastal 14.0 SEER Heat Pump 14.0 SEER/11.5-11.7 EER/8.2 HSPF R-410A Refrigerant

2 – 5 Tons Split System  
208 / 230 Volt, Single-Phase, 60 Hz



### Refrigeration Circuit

- Scroll compressors on all models
- Suction line accumulator factory installed
- Bi-flow filter drier included for field installation
- Integrated solid-state control with Time-Temperature Defrost
- High- and low-pressure switches
- Copper tube/aluminum fin coil

### Built to Last

- Baked-on powder coat finish on all sides
- Corrosion protection epoxy phenolic coated aluminum fins
- Coated, weather-resistant cabinet screws
- Coated inlet grille with 3/8" (10mm) spacing for extra protection (hail guard)

### Easy-to-Install and Service

- Easy access service valves on all models
- External high- and low-refrigerant service ports
- Only two screws to access control panel
- Factory charged with R-410A refrigerant
- Ion™ system control compatible with communicating relay module (see SYST0101CW Product Specification for details)

### Warranty\*

- Five-year compressor limited warranty (including compressor and coil)
  - With timely registration, an additional five-year parts limited warranty (including compressor and coil)

\* For residential applications only. See warranty certificate for complete details and restrictions, including warranty coverage for other applications.

### Unit Performance Data

Model Number	Size (tons)	Nominal Btu/hr	Min. Circuit Ampacity	Max. Fuse or Breaker	Operating Dimensions H x W x D (sq) in (mm)	Ship/Operating Weight lbs (kg)
N4H418CKG	1-1/2	18,000	12.4	20	35-3/4 x 25-3/4 x 25-3/4 (895 x 654 x 654)	162/136 (73/61)
N4H424CKG	2	24,000	14.7	25	38-7/8 x 31-3/16 x 31-3/16 (988 x 792 x 792)	195/160 (89/72)
N4H430CKG	2-1/2	30,000	18.3	30	28-7/16 x 31-3/16 x 31-3/16 (722 x 792 x 792)	196/162 (89/73)
N4H436CKG	3	36,000	21.5	35	32-1/16 x 31-3/16 x 31-3/16 (815 x 792 x 792)	225/189 (102/86)
N4H442CKG	3-1/2	42,000	31.2	50	28-7/16 x 31-3/16 x 31-3/16 (722 x 792 x 792)	237/203 (108/92)
N4H448CKG	4	48,000	28.0	40	35-1/2 x 31-3/16 x 31-3/16 (901 x 792 x 792)	259/223 (117/101)
N4H460CKG	5	60,000	32.5	50	38-7/8 x 31-3/16 x 31-3/16 (988 x 792 x 792)	269/233 (122/106)





# NH4H4

## 14.0 SEER Horizontal Discharge Heat Pump For Use with Ducted Indoor Units Environmentally Sound R-410A Refrigerant 1-1/2 – 5 Tons Split System, 208 / 230 Volt, Single-Phase

### Refrigeration Circuit

- 14.0-16.0 SEER/11.0-13.0 EER/ 8.2-9.0 HSPF
- Scroll compressors on all models
- Factory-supplied filter-drier
- High- and low-pressure switches
- Line lengths up to 250 feet (76.2m)
- Accumulator

### Easy-to-Install and Service

- Small footprint
- Easy access service valves on all models
- Factory charged with R-410A refrigerant
- Ion™ system control compatible with communicating relay module (see SYST0101CW Product Specification for details)

### Built to Last

- Low-ambient operation (down to 0°F/-17.8°C)
- Ball bearing fan motor

### Warranty\*

- Five-year compressor limited warranty (including compressor and coil)
  - With timely registration, an additional five-year parts limited warranty (including compressor and coil)

\* For residential applications only.

See warranty certificate for complete details and restrictions, including warranty coverage for other applications.

### Unit Performance Data

Model Number	Size (tons)	Nominal Btu/hr	Min. Circuit Ampacity	Max. Fuse or Breaker	Operating Dimensions H x W x D (sq) in (mm)	Ship/Operating Weight lbs (kg)
<b>208/230-1-60</b>						
NH4H418AKA	1-1/2	18,000	11.8	20	25-1/8 x 36-15/16 x 14-9/16 (638 x 938 x 370)	170/150 (77/68)
NH4H424AKA	2	24,000	16.5	25	31-1/8 x 36-15/16 x 14-9/16 (790 x 938 x 370)	181/161 (82/73)
NH4H430AKA	2-1/2	30,000	17.2	30	37-1/8 x 44-1/2 x 17-1/16 (943 x 1130 x 433)	226/196 (89/103)
NH4H436AKA	3	36,000	19.0	30	37-1/8 x 44-1/2 x 17-1/16 (943 x 1130 x 433)	197/227 (103/89)
NH4H448AKA	4	48,000	28.8	50	43-1/8 x 44-1/2 x 17-1/16 (1095 x 1130 x 433)	276/246 (125/112)
NH4H460AKA	5	60,000	33.4	50	43-1/8 x 44-1/2 x 17-1/16 (1095 x 1130 x 433)	288/258 (131/117)

# R4H4

## High-Efficiency 14.0 SEER Heat Pump Environmentally Balanced R-410A Refrigerant

1-1/2 – 5 Tons Split System  
208 / 230 Volt, Single-Phase, 60 Hz



### Refrigeration Circuit

- Scroll compressors on all models
- Suction line accumulator factory installed
- Integrated solid-state control with Time-Temperature Defrost
- High- and low-pressure switches
- Copper tube/aluminum fin coil

### Easy-to-Install and Service

- Easy access service valves on all models
- External high- and low-refrigerant service ports
- Only two screws to access control panel
- Factory charged with R-410A refrigerant
- Ion™ system control compatible with communicating relay module (see SYST0101CW Product Specification for details)

### Warranty\*

- Five-year compressor limited warranty
- Five-year compressor limited warranty (including compressor and coil) – With timely registration, an additional five-year parts limited warranty (including compressor and coil)

\* For residential applications only. See warranty certificate for complete details and restrictions, including warranty coverage for other applications.

### Built to Last

- Painted cabinet finish over galvanized steel
- Coated inlet grille with 3/8" (10mm) spacing for extra protection

### Unit Performance Data

Model Number	Size (tons)	Nominal Btu/hr	Min. Circuit Ampacity	Max. Fuse or Breaker	Operating Dimensions H x W x D (sq) in (mm)	Ship/Operating Weight lbs (kg)
R4H418AKC	1-1/2	18,000	11.8	20	35-1/16 x 23-1/8 x 23-1/8 (891 x 587 x 587)	166/136 (75/61)
R4H418GKC	1-1/2	18,000	11.8	20	35-1/16 x 23-1/8 x 23-1/8 (891 x 587 x 587)	166/136 (75/61)
R4H424AKC	2	24,000	14.2	25	35-1/2 x 25-3/4 x 25-3/4 (901 x 654 x 654)	175/144 (79/65)
R4H424GKC	2	24,000	14.2	25	35-1/2 x 25-3/4 x 25-3/4 (901 x 654 x 654)	175/144 (79/65)
R4H430AKC	2-1/2	30,000	18.3	30	31-11/16 x 31-3/16 x 31-3/16 (804 x 792 x 792)	180/158 (82/72)
R4H430GKC	2-1/2	30,000	18.3	30	31-11/16 x 31-3/16 x 31-3/16 (804 x 792 x 792)	180/158 (82/72)
R4H436AKC	3	36,000	20.0	30	28-1/4 x 31-3/16 x 31-3/16 (630 x 792 x 792)	201/170 (91/77)
R4H436GKC	3	36,000	20.0	30	28-1/4 x 31-3/16 x 31-3/16 (630 x 792 x 792)	201/170 (91/77)
R4H442AKC	3-1/2	42,000	24.0	40	38-7/16 x 31-3/16 x 31-3/16 (977 x 792 x 792)	235/201 (107/91)
R4H442GKC	3-1/2	42,000	24.0	40	38-7/16 x 31-3/16 x 31-3/16 (977 x 792 x 792)	235/201 (107/91)
R4H448AKC	4	48,000	25.2	40	28-1/4 x 31-3/16 x 31-3/16 (718 x 792 x 792)	232/197 (105/89)
R4H448GKC	4	48,000	25.2	40	28-1/4 x 31-3/16 x 31-3/16 (718 x 792 x 792)	232/197 (105/89)
R4H460AKC	5	60,000	32.0	50	31-11/16 x 31-3/16 x 31-3/16 (804 x 792 x 792)	248/212 (113/96)
R4H460GKC	5	60,000	32.0	50	31-11/16 x 31-3/16 x 31-3/16 (804 x 792 x 792)	248/212 (113/96)

A = 2" (51 mm) spacing inlet grille G = 3/8" (10 mm) spacing inlet grille

# Accessories

## Residential Heat Pumps

TSH6, TSH5, TSH4, N4H6, NXH6, NXH5, N4H4, R4H4			
Part Number	Description	Model	Used on Size
NASA00501CH	Crankhouse Heater for Scroll Compressor (208/230 V) (factory installed on some models)	TSH6	42, 48
		TSH5	36, 42
		TSH4	42, 60
		NXH5	42
NASA00601CH	Crankhouse Heater for Scroll Compressor (208/230 V) (factory installed on some models)	N4H4-C	24, 30, 36, 42
		TSH6	18, 24, 30
		TSH5	18, 24, 30
		TSH4	18, 24, 30
		NXH5	24
NASA001CH	Crankhouse Heater for Scroll Compressor (single-phase, 208/230 V)	N4H4-C	48, 60
		N4H4-G	42, 48, 60
		R4H4	42, 48, 60
		NXH6, NXH5	48, 60
NASA003CH	Crankhouse Heater for Scroll Compressor (single-phase, 208/230 V)	N4H4-C	18
		N4H4-G	18, 24, 30, 36
		R4H4	18, 24, 30, 36
		N4H6	24, 36
		NXH5	18, 30, 36
NASA003SC	Hard Start Kit (single-phase units only)	TSH6	36, 60
		N4H4-C	18
		N4H4-G	ALL
		R4H4	ALL
		N4H6	ALL
		NXH6	36, 60
		NXH5	18, 30, 36
NASA005SC	Hard Start Kit	N4H4-C	24, 30, 36, 42, 48, 60
		TSH4	42, 48, 60
NASA007SC	Hard Start Kit	TSH6, NXH6	18, 24, 30, 42, 48
NASA014SC	Hard Start Kit (Capacitor & Relay)	TSH4	18, 24, 30, 36
NASA001SJ	Sound Jacket, Compressor (factory installed on some models)	N4H4-C	18, 24, 30, 36, 42, 48
		TSH4	48
		N4H6	36, 48
		NXH5	ALL
		N4H4-G, R4H4	36, 42, 48
NASA002SJ	Sound Jacket, Compressor (factory installed on some models)	N4H6	24
		N4H4-G, R4H4	18, 24, 30
NASA003SJ	Sound Jacket, Compressor (factory installed on some models)	N4H4-C, N4H4-G R4H4, N4H6	60
		TSH4	42, 60
NASA00201SJ	Sound Jacket, Compressor	NXH6	18, 24, 30, 36
NASA00101SJ	Sound Jacket, Compressor	NXH6	42, 48, 60

Some accessories may be factory installed. Refer to product specifications for exact accessory match.

# Accessories

## Residential Heat Pumps

TSH6, TSH5, TSH4, N4H6, NXH6, NXH5, N4H4, R4H4 – Continued			
Part Number	Description	Model	Used on Size
TSTAT0201CW	Observer® Self-Configuring Communicating Wi-Fi® Wall Control	TSH6	ALL
		TSH5, TSH4	
SYST0101CW	Ion™ Communicating System Control		ALL
NAEB40501TX	TXV Kit, R-410A - for use with aluminum piston coils	ALL	18, 24, 30
		N4H7	24
NAEB40601TX		ALL	36, 42
		TSH4, N4H7	36
NAEB40701TX		TSH4	42, 48, 60
		ALL	48, 60
NAEA40501TX	TXV Kit, R-410A - for use with copper or tin piston coils	ALL	18, 24, 30
NAEA40601TX		ALL	36, 42
NAEA40701TX		ALL	48, 60
NASA00201FS	Evaporator Freeze Thermostat		ALL
NASA001LS	Liquid Line Solenoid Valve, HP, R-22 or R-410A		ALL
NASA401LS	Liquid Line Solenoid Valve, HP, R-22 or R-410A		ALL TSH4
NASA001TD	Time Delay Relay, Indoor Blower		ALL
NASA001AC	Anti-Cycle Timer (5-minute delay)		ALL
NASA001SC	Start Component - PTC Device		ALL
NASA401LA	Low-Ambient Pressure Switch		ALL
NASA00101IK	Low-Ambient Isolation Relay Kit		ALL
NASA001SF	Support Feet, 4" (102 mm) tall (4 blocks)		31-1/4" and 35" Width Units
NASA00201SF	Support Feet, 4" (102 mm) tall (5 blocks)		23-1/8" and 25-3/4" Width Units
TCH624-60GKA1 (R-410A Two-Stage Communicating Heat Pump)			
Part Number	Description	Used on Model Size	
NASA001LS	Liquid Line Solenoid Valve, R-410A	ALL	
NASA001TD	Time Delay Relay, Indoor Blower	ALL	
NASA001SF	Support Feet, 4" (102 mm) tall (4 blocks)	31-1/4" and 35" Width Units	
NASA00201SF	Support Feet, 4" (102 mm) tall (5 blocks)	23-1/8" and 25-3/4" Width Units	
NASA010SC	Hard Start Kit	24	
NASA011SC	Hard Start Kit	36	
NASA012SC	Hard Start Kit	48	
NASA013SC	Hard Start Kit	60	
TSTAT0201CW	Observer® Self-Configuring Communicating Wi-Fi® Wall Control	ALL	
SYST0101CW	Ion™ Communicating System Control	ALL	
TCH624-60GKA2/3 (R-410A Two-Stage Communicating Heat Pump)			
NASA401LS	Liquid Line Solenoid Valve, R-410A	ALL	
NASA001TD	Time Delay Relay, Indoor Blower	ALL	
NASA001SF	Support Feet, 4" (102 mm) tall (4 blocks)	31-1/4" and 35" Width Units	
NASA00201SF	Support Feet, 4" (102 mm) tall (5 blocks)	23-1/8" and 25-3/4" Width Units	
NASA012SC	Hard Start Kit	24, 36	
NASA015SC	Hard Start Kit	48, 60	
TSTAT0201CW	Observer® Self-Configuring Communicating Wi-Fi® Wall Control	ALL	
SYST0101CW	Ion™ Communicating System Control	ALL	

Some accessories may be factory installed. Refer to product specifications for exact accessory match.

# Accessories

## Residential Heat Pumps

TVH8 (R-410A, Five-Stage Communicating Heat Pump)		
Part Number	Description	Used on Model Size
SYST0201CW	Ion™ System Control	(see Ion product pages for additional Accessories)
TSTAT0201CW	Observer® Self-Configuring Communicating Wi-Fi® Wall Control	ALL
NASA00201SF	Support Feet, 4" (102 mm) tall	24, 25, 36, 37, 48, 60
NASA00201FS*	Freeze Thermostat Kit	ALL
NAEA40501TX	TXV Kit, R-410A - for use with copper or tin piston coils	24, 25
NAEA40601TX		36, 37
NAEA40701TX		48, 60
NAEB40501TX	TXV Kit, R-410A - for use with aluminum piston coils	24, 25
NAEB40601TX		36, 37
NAEB40701TX		48, 60
1187979	Vapor Line Muffler	ALL

\* Non-communicating

## Residential Ducted Horizontal Heat Pumps – NH4H4

Kit Number	Description	Unit Size (Voltage/Series)											
		18	24	30	36	36	36	48	48	48	60	60	60
		AKA	AKA	AKA	AKA	AHA	ALA	AKA	AHA	ALA	AKA	AHA	ALA
NASA00601CH	Crankcase Heater	X	X	S	S	S	S						
NASA00501CH	Crankcase Heater							X	X		X	X	
NASA00301CH	Crankcase Heater									X			X
NASA001SC	PTC Start Assist	X	X	X	X			X			X		
NASA00201FS	Evaporator Freeze Stat	X	X	X	X	X	X	X	X	X	X	X	X
NASA001TD	Time Delay Relay	X	X	X	X	X	X	X	X	X	X	X	X
NASA00101IK	Isolation Relay	X	X	X	X	X	X	X	X	X	X	X	X
NASA401LA	Low-Ambient Kit	X	X	X	X	X	X	X	X	X	X	X	X
NASA00101WB	Wind Baffle	X											
NASA00201WB	Wind Baffle		X										
NASA00301WB	Wind Baffle			X	X	X	X						
NASA00401WB	Wind Baffle							X	X	X	X	X	X
NASA00101WM	Wall Mounting Kit	X	X										
NASA00201WM	Wall Mounting Kit			X	X	X	X	X	X	X	X	X	X
1177810	Sound Blanket Kit	X	X	X	X	X	X						
NASA001LS	Solenoid Valve Kit	X	X	X	X	X	X	X	X	X	X	X	X
NASA003SC	Capacitor Relay Start Assist	X	X	X	X			X			X		
NASA001AC	Cycle Protector	X	X	X	X	X	X	X	X	X	X	X	X

X = Accessory  
S = Standard

Specifications subject to change without notice.



# 90% Condensing Gas Furnaces



*All condensing furnaces are Low NOx units designed for California installations and meet 40 ng/J NOx emissions. Can be installed in air quality management districts with a 40 ng/J NOx emissions requirement.*

# F97CMN

## Up to 98% AFUE Communicating, Modulating Gas Furnace

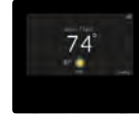

SYST0101CW  
Recommended  
(Sold separately)



TSTAT0201CW  
Recommended  
(Sold separately)



### Easier to Sell

- Up to 98% AFUE in upflow and horizontal positions
- Up to 96.7% AFUE in downflow
- Modulating heating operation (40% - 100% capacity)
- Observer® Communicating Control System
- ION™ Communicating Control System
- Variable-speed, constant airflow ECM blower motor
- Supports single, two-stage, and variable-speed cooling units
- Dehumidification feature in cooling
- Cabinet air leakage less than 2.0% at 1.0 in. W.C. and cabinet air leakage less than 1.4% at 0.5 in. W.C. when tested in accordance with ASHRAE standard 193

### Tougher

- Flame roll-out sensors standard
- Adjustable heating blower OFF delay
- Factory set blower ON delay
- RPJ® primary heat exchanger
- Stainless steel secondary heat exchanger
- High temperature limit control prevents overheating
- Direct ignition with Silicon Nitride ignitor

### Quieter

- Operates at lower heating rates for quieter operation
- Variable-speed induced draft combustion blower
- Variable-speed ECM blower motor
- Fully insulated steel cabinet

### Easy-to-Install and Service

- Direct vent (2-pipe), single pipe venting, or ventilated combustion air
- 24 VAC humidifier terminal
- Electronic air cleaner terminal
- 35" (889mm) high, for ease of installation and room for service
- Quarter turn knobs for easy door removal and secure attachment
- Factory shipped for natural gas, with propane gas conversion kits available
- Four position - upflow/downflow/horizontal (left/right) installation
- At least twelve different venting configurations
- Through the casing flue pipe for counterflow or horizontal applications with accessory kit (order separately)
- Concentric vent available
- Simple troubleshooting of gas valve
- Self-configuring and communicating control
- Slide out heat exchanger assembly and blower assembly

### Limited Warranty\*

- 10-year No Hassle Replacement™ limited warranty
- Lifetime heat exchanger limited warranty with timely registration
- 5-year parts limited warranty
  - With timely registration, an additional 5-year parts limited warranty

\* For residential applications only. See warranty certificate for complete details and restrictions, including warranty coverage for other applications.

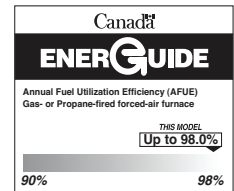

### Unit Performance Data

Model Number	Heating Input (MBTUH)	Efficiency Range AFUE		Energy Star®	Cooling Capacity CFM range @ .5 in wc (125 PA)	Operating Dimensions H x W x D (sq) in (mm)	Shipping Weight lbs (kg)
		Upflow/Hz	Downflow				
F97CMN0601714A	60,000	97.0%	95.0%	•	510 – 1335	35 x 17-1/2 x 29-1/2 (889 x 445 x 750)	154 (69)
F97CMN0602120A	60,600	98.0%	96.7%	•	510 – 1905	35 x 21 x 29-1/2 (889 x 533 x 750)	159 (72)
F97CMN0801714A	80,000	97.0%	95.0%	•	490 – 1375	35 x 17-1/2 x 29-1/2 (889 x 445 x 750)	164 (74)
F97CMN0802120A	80,000	97.0%	95.0%	•	750 – 1945	35 x 21 x 29-1/2 (889 x 533 x 750)	169 (77)
F97CMN1002122A	100,000	97.0%	95.0%	•	715 – 2160	35 x 21 x 29-1/2 (889 x 533 x 750)	179 (80)
F97CMN1202422A	120,000	97.0%	95.0%	•	885 – 2185	35 x 24-1/2 x 29-1/2 (889 x 622 x 750)	203 (91)



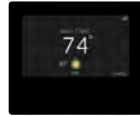

SYST0101CW  
Recommended  
(Sold separately)

# F96CTN

## Up to 96.7% AFUE, Communicating, Two-Stage Gas Furnace

### Easier to Sell

- Up to 96.7% AFUE in upflow and horizontal positions
- 95% AFUE in downflow position
- Two-stage heating operation
- ION™ Communicating Control System
- Variable-speed, constant airflow ECM blower motor for extra SEER boost with select cooling equipment
- Supports single, two-stage, and variable-speed cooling units
- Dehumidification feature in cooling
- Cabinet air leakage less than 2.0% at 1.0 in. W.C. and cabinet air leakage less than 1.4% at 0.5 in. W.C. when tested in accordance with ASHRAE standard 193

### Tougher

- Flame roll-out sensors standard
- Adjustable heating blower OFF delay
- Factory set blower ON delay
- RPJ® primary heat exchanger
- Stainless steel secondary heat exchanger
- High temperature limit control prevents overheating
- Direct ignition with Silicon Nitride ignitor

### Quieter

- Operates in low stage heating for longer for quieter operation
- Two-speed induced draft combustion blower
- Variable-speed, constant airflow ECM blower motor
- Fully insulated steel cabinet

### Easy-to-Install and Service

- Direct vent (2-pipe), single-pipe venting or ventilated combustion air
- 24 VAC humidifier terminal
- Electronic air cleaner terminal
- 35" (889mm) high, for ease of installation
- Quarter turn knobs for easy door removal and secure attachment
- Factory shipped for natural gas, with propane gas conversion kits available
- Four position - upflow/downflow/horizontal (left/right) installation
- At least twelve different venting configurations
- Through the casing flue pipe for counter-flow or horizontal applications with accessory (order separately)
- Self-configuring and communicating control
- Concentric vent available
- Slide out heat exchanger assembly and blower assembly

### Limited Warranty\*

- 10-year No Hassle Replacement™ limited warranty
- Lifetime heat exchanger limited warranty with timely registration
- 5-year parts limited warranty
  - With timely registration, an additional 5-year parts limited warranty

\* For residential applications only. See warranty certificate for complete details and restrictions, including warranty coverage for other applications.

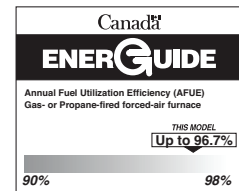

### Unit Performance Data

Model Number	Heating Input (MBTUH)	Efficiency Range AFUE		Energy Star®	Cooling Capacity CFM range @ .5 in wc (125 PA)	Operating Dimensions H x W x D (sq) in (mm)	Shipping Weight lbs (kg)
		Upflow/Hz	Downflow				
F96CTN0601714	60,000	96.3%	95.0%	•	530 - 1280	35 x 17-1/2 x 29-1/2 (889 x 361 x 750)	151.0 (68.5)
F96CTN0801714	80,000	96.2%	95.0%	•	520 - 1310	35 x 17-1/2 x 29-1/2 (889 x 445 x 750)	152.5 (69.2)
F96CTN0802120	80,000	96.7%	95.0%	•	750 - 1945	35 x 21 x 29-1/2 (889 x 533 x 750)	171.5 (77.8)
F96CTN1002122	100,000	96.1%	95.0%	•	715 - 2160	35 x 21 x 29-1/2 (889 x 533 x 750)	179.0 (81.2)
F96CTN1202422	120,000	96.7%	95.0%	•	705 - 2135	35 x 24-1/2 x 29-1/2 (889 x 622 x 750)	195.0 (88.4)

# F96VTN

## Up to 96% AFUE, Variable-speed, Two-Stage Gas Furnace



### Easier to Sell

- Up to 96% AFUE in upflow and horizontal positions
- 95% AFUE in downflow position
- Two-stage heating operation
- Variable-speed, constant torque ECM blower for extra SEER boost with select cooling equipment
- Supports single- and two-stage cooling units
- Dehumidification feature in cooling
- Cabinet air leakage less than 2.0% at 1.0 in. W.C. and cabinet air leakage less than 1.4% at 0.5 in. W.C. when tested in accordance with ASHRAE standard 193

### Limited Warranty\*

- 5-year No Hassle Replacement™ limited warranty
- Lifetime heat exchanger limited warranty with timely registration
- 5-year parts limited warranty
  - With timely registration, an additional 5-year parts limited warranty

\* For residential applications only. See warranty certificate for complete details and restrictions, including warranty coverage for other applications.

### Tougher

- Flame roll-out sensors standard
- Adjustable heating blower OFF delay
- Factory set blower ON delay
- RPJ® primary heat exchanger
- Stainless steel secondary heat exchanger
- High temperature limit control prevents overheating
- Direct ignition with Silicon Nitride ignitor

### Quieter

- Operates in low stage heating for longer for quieter operation
- Two-speed induced draft combustion blower
- Variable-speed, constant torque ECM blower motor
- Fully insulated steel cabinet

### Easy-to-Install and Service

- Direct vent (2-pipe), single-pipe venting or ventilated combustion air
- 24 VAC humidifier terminal
- Electronic air cleaner terminal
- 35" (889mm) high, for ease of installation
- Quarter turn knobs for easy door removal and secure attachment
- Factory shipped for natural gas, with propane gas conversion kits available
- Four position - upflow/downflow/horizontal (left/right) installation
- At least twelve different venting configurations
- Through the casing flue pipe for counterflow or horizontal applications with accessory (order separately)
- Concentric vent available
- Slide out heat exchanger assembly and blower assembly
- Twinning capable (model sizes 0601714, 0801716, 1002120, 1202422)
- 5 ton sizes (sizes 0802120, 1002120) allow 15 Amp breaker with accessory (order separately)

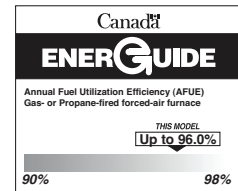

### Unit Performance Data

Model Number	Heating Input (MBTUH)	Efficiency Range AFUE		Energy Star®	Cooling Capacity CFM range @ .5 in wc (125 PA)	Operating Dimensions H x W x D (sq) in (mm)	Shipping Weight lbs (kg)
		Upflow/Hz	Downflow				
F96VTN0401410	40,000	95.0%	95.0%	•	445 - 1030	35 x 14-3/16 x 29-1/2 (889 x 361 x 750)	123 (55.8)
F96VTN0401712	40,000	96.0%	95.0%	•	400 - 1105	35 x 17-1/2 x 29-1/2 (889 x 445 x 750)	133 (60.3)
F96VTN0601412	60,000	95.0%	95.0%	•	445 - 1115	35 x 14-3/16 x 29-1/2 (889 x 361 x 750)	132 (59.9)
F96VTN0601714	60,000	96.0%	95.0%	•	210 - 1475	35 x 17-1/2 x 29-1/2 (889 x 445 x 750)	139 (63.0)
F96VTN0801716	80,000	96.0%	95.0%	•	360 - 1655	35 x 17-1/2 x 29-1/2 (889 x 445 x 750)	147 (66.7)
F96VTN0802120	80,000	96.0%	95.0%	•	440 - 2005	35 x 21 x 29-1/2 (889 x 533 x 750)	156 (70.7)
F96VTN1002120	100,000	96.0%	95.0%	•	405 - 2005	35 x 21 x 29-1/2 (889 x 533 x 750)	170 (77.1)
F96VTN1202422	120,000	96.0%	95.0%	•	505 - 2190	35 x 24-1/2 x 29-1/2 (889 x 622 x 750)	190 (86.2)



# N95ESN

## Up to 96% AFUE Single-Stage, ECM Gas Furnace

### Easier to Sell

- Up to 96% AFUE in upflow and horizontal positions
- Up to 95% AFUE in downflow position
- Single-stage gas valve
- Fixed-speeds, constant torque ECM blower motor
- Supports single-stage cooling units
- Insulated heat exchanger compartment
- Approved for Twinning application (0601714 through 1002120) with accessory (order separately)
- Approved for Manufactured Housing/Mobile Home applications (0401410 through 1202422) with accessory (order separately)
- Cabinet air leakage less than 2.0% at 1.0 in. W.C. and cabinet air leakage less than 1.4% at 0.5 in. W.C. when tested in accordance with ASHRAE standard 193

### Tougher

- Flame roll-out sensors standard
- Adjustable heating blower OFF delay
- Factory set blower ON delay
- Stainless steel secondary heat exchanger
- High temperature limit control prevents overheating
- Direct ignition with Silicon Nitride ignitor
- High quality, corrosion-resistant, prepainted steel cabinet

### Easy-to-Install and Service

- Direct vent (2-pipe), single-pipe venting or ventilated combustion air
- 24 VAC humidifier terminal
- Electronic air cleaner terminal
- 35" (889mm) high, for ease of installation
- Quarter turn knobs for easy door removal and secure attachment
- Factory shipped for natural gas, with propane gas conversion kits available
- Four position - upflow/downflow/horizontal (left/right) installation
- At least twelve different venting configurations
- Through the casing flue pipe for counterflow or horizontal applications with accessory (order separately)
- Concentric vent available
- Self diagnostics with super bright LED
- Slide out heat exchanger and blower assembly

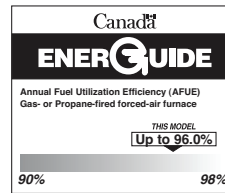

### Limited Warranty\*

- Lifetime heat exchanger limited warranty
- 5-year parts limited warranty - With timely registration, an additional 5-year parts limited warranty

\* For residential applications only. See warranty certificate for complete details and restrictions, including warranty coverage for other applications.

### Unit Performance Data

Model Number	Heating Input (MBTUH)	Efficiency Range AFUE		Energy Star®	Cooling Capacity CFM range @ .5 in wc (125 PA)	Operating Dimensions H x W x D (sq) in (mm)	Shipping Weight lbs (kg)
		Upflow/Hz	Downflow				
N95ESN0261410A	26,000	96.0%	95.0%	•	235 - 895	35 x 14-3/16 x 29-1/2 (889 x 361 x 750)	118.0 (53.5)
N95ESN0401410A	40,000	96.0%	95.0%	•	365 - 950	35 x 14-3/16 x 29-1/2 (889 x 361 x 750)	120.0 (54.4)
N95ESN0401712A	40,000	96.0%	95.0%	•	270 - 1010	35 x 17-1/2 x 29-1/2 (889 x 445 x 750)	126.5 (57.4)
N95ESN0601412A	60,000	95.0%	95.0%	•	345 - 1120	35 x 14-3/16 x 29-1/2 (889 x 361 x 750)	129.0 (58.5)
N95ESN0601714A	60,000	96.0%	95.0%	•	460 - 1330	35 x 17-1/2 x 29-1/2 (889 x 445 x 750)	138.5 (62.8)
N95ESN0801716A	80,000	96.0%	95.0%	•	935 - 1665	35 x 17-1/2 x 29-1/2 (889 x 445 x 750)	146.5 (66.5)
N95ESN0802120A	80,000	96.0%	95.0%	•	895 - 1855	35 x 21 x 29-1/2 (889 x 533 x 750)	154.5 (70.1)
N95ESN1002120A	100,000	96.0%	95.0%	•	1110 - 2125	35 x 21 x 29-1/2 (889 x 533 x 750)	164.5 (74.6)
N95ESN1202422A	120,000	96.0%	95.0%	•	710 - 2105	35 x 24-1/2 x 29-1/2 (889 x 622 x 750)	179.5 (81.4)
N95ESN1402422A	140,000	95.0%	95.0%	•	470 - 2310	35 x 24-1/2 x 29-1/2 (889 x 622 x 750)	189.0 (85.7)

# N92ESN

## Up to 92.1% AFUE, Single-Stage Gas Furnace



### Easier to Sell

- Up to 92.1% AFUE in upflow, horizontal, and downflow positions
- Single-stage gas valve and fixed-speeds, constant torque ECM.
- Cabinet air leakage less than 2.0% at 1.0 in. W.C. and cabinet air leakage less than 1.4% at 0.5 in. W.C. when tested in accordance with ASHRAE standard 193
- Approved for Manufactured Housing/Mobile Home applications (0401410 through 1202422) with accessory (order separately)
- Supports single speed cooling units

### Tougher

- Flame roll-out sensors standard
- Adjustable heating blower OFF delay
- Factory set blower ON delay
- RPJ® primary heat exchanger
- Stainless steel secondary heat exchanger
- High temperature limit control prevents overheating
- Direct ignition with Silicon Nitride ignitor
- High quality, corrosion-resistant, prepainted steel cabinet

### Easy-to-Install and Service

- Direct vent (2-pipe), single-pipe venting or ventilated combustion air
- 24 VAC humidifier terminal & electronic air cleaner terminal
- 35" (889mm) high, for ease of installation
- Simplified, factory installed internal condensate drain system
- Quarter turn knobs for easy door removal and secure attachment
- Factory shipped for natural gas, with propane gas conversion kits available
- Four position - upflow/downflow/horizontal (left/right) installation
- At least twelve different venting configurations
- Through the casing flue pipe for counterflow or horizontal applications with accessory (order separately)
- Concentric vent available
- Self diagnostics with super bright LED
- Slide out heat exchanger and blower assembly

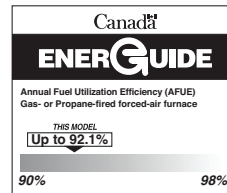

### Limited Warranty\*

- 20-year heat exchanger limited warranty
- 5-year parts limited warranty
  - With timely registration, an additional 5-year parts limited warranty

\* For residential applications only. See warranty certificate for complete details and restrictions, including warranty coverage for other applications.

### Unit Performance Data

Model Number	Heating Input (MBTUH)	Efficiency Range AFUE		Cooling Capacity CFM range @ .5 in wc (125 PA)	Operating Dimensions H x W x D (sq) in (mm)	Shipping Weight lbs (kg)
		Upflow/Hz	Downflow			
N92ESN0401410A	40,000	92.1%	92.1%	290 - 985	35 x 14-3/16 x 29-1/2 (889 x 361 x 750)	112 (50.8)
N92ESN0401712A	40,000	92.1%	92.1%	350 - 985	35 x 17-1/2 x 29-1/2 (889 x 445 x 750)	122.5 (55.6)
N92ESN0601412A	60,000	92.1%	92.1%	450 - 1035	35 x 14-3/16 x 29-1/2 (889 x 361 x 750)	122 (55.3)
N92ESN0601714A	60,000	92.1%	92.1%	535 - 1190	35 x 17-1/2 x 29-1/2 (889 x 445 x 750)	132 (59.9)
N92ESN0801716A	80,000	92.1%	92.1%	450 - 1365	35 x 17-1/2 x 29-1/2 (889 x 445 x 750)	142 (64.4)
N92ESN0802120A	80,000	92.1%	92.1%	940 - 1815	35 x 21 x 29-1/2 (889 x 533 x 750)	150 (68.0)
N92ESN1002120A	100,000	92.1%	92.1%	945 - 1850	35 x 21 x 29-1/2 (889 x 533 x 750)	160 (72.6)
N92ESN1202420A	120,000	92.1%	92.1%	805 - 1850	35 x 24-1/2 x 29-1/2 (889 x 622 x 750)	183 (83.0)



# R95ESN

## Up to 96% AFUE Single-Stage, ECM Gas Furnace

### Easier to Sell

- Up to 96% AFUE in upflow and horizontal positions
- Up to 95% AFUE in downflow position
- Single-stage gas valve
- Fixed-speeds, constant torque ECM blower motor
- Supports single-stage cooling units
- Insulated heat exchanger compartment
- Approved for Twinning application (0601714 through 1002120) with accessory (order separately)
- Approved for Manufactured Housing/Mobile Home applications (0401410 through 1202422) with accessory (order separately)
- Cabinet air leakage less than 2.0% at 1.0 in. W.C. and cabinet air leakage less than 1.4% at 0.5 in. W.C. when tested in accordance with ASHRAE standard 193

### Tougher

- Flame roll-out sensors standard
- Adjustable heating blower OFF delay
- Factory set blower ON delay
- Stainless steel secondary heat exchanger
- High temperature limit control prevents overheating
- Direct ignition with Silicon Nitride ignitor
- High quality, corrosion-resistant, prepainted steel cabinet

### Easy-to-Install and Service

- Direct vent (2-pipe), single-pipe venting or ventilated combustion air
- 24 VAC humidifier terminal
- Electronic air cleaner terminal
- 35" (889mm) high, for ease of installation
- Quarter turn knobs for easy door removal and secure attachment
- Factory shipped for natural gas, with propane gas conversion kits available
- Four position - upflow/downflow/horizontal (left/right) installation
- At least twelve different venting configurations
- Through the casing flue pipe for counterflow or horizontal applications with accessory (order separately)
- Concentric vent available
- Self diagnostics with super bright LED
- Slide out heat exchanger and blower assembly

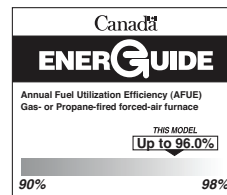

### Limited Warranty\*

- 20-year heat exchanger limited warranty
- 5-year parts limited warranty - With timely registration, an additional 5-year parts limited warranty

\* For residential applications only. See warranty certificate for complete details and restrictions, including warranty coverage for other applications.

### Unit Performance Data

Model Number	Heating Input (MBTUH)	Efficiency Range AFUE		Energy Star®	Cooling Capacity CFM range @ .5 in wc (125 PA)	Operating Dimensions H x W x D (sq) in (mm)	Shipping Weight lbs (kg)
		Upflow/Hz	Downflow				
R95ESN0261410A	26,000	96.0%	95.0%	•	235 - 895	35 x 14-3/16 x 29-1/2 (889 x 361 x 750)	118.0 (53.5)
R95ESN0401410A	40,000	96.0%	95.0%	•	365 - 950	35 x 14-3/16 x 29-1/2 (889 x 361 x 750)	120.0 (54.4)
R95ESN0401712A	40,000	96.0%	95.0%	•	270 - 1010	35 x 17-1/2 x 29-1/2 (889 x 445 x 750)	126.5 (57.4)
R95ESN0601412A	60,000	95.0%	95.0%	•	345 - 1120	35 x 14-3/16 x 29-1/2 (889 x 361 x 750)	129.0 (58.5)
R95ESN0601714A	60,000	96.0%	95.0%	•	460 - 1330	35 x 17-1/2 x 29-1/2 (889 x 445 x 750)	138.5 (62.8)
R95ESN0801716A	80,000	96.0%	95.0%	•	935 - 1665	35 x 17-1/2 x 29-1/2 (889 x 445 x 750)	146.5 (66.5)
R95ESN0802120A	80,000	96.0%	95.0%	•	895 - 1855	35 x 21 x 29-1/2 (889 x 533 x 750)	154.5 (70.1)
R95ESN1002120A	100,000	96.0%	95.0%	•	1110 - 2125	35 x 21 x 29-1/2 (889 x 533 x 750)	164.5 (74.6)
R95ESN1202422A	120,000	96.0%	95.0%	•	710 - 2105	35 x 24-1/2 x 29-1/2 (889 x 622 x 750)	179.5 (81.4)
R95ESN1402422A	140,000	95.0%	95.0%	•	470 - 2310	35 x 24-1/2 x 29-1/2 (889 x 622 x 750)	189.0 (85.7)

# R92ESN

## Up to 92.1% AFUE, Single-Stage Gas Furnace



### Easier to Sell

- Up to 92.1% AFUE in upflow, horizontal, and downflow positions
- Single-stage gas valve and fixed-speeds, constant torque ECM.
- Cabinet air leakage less than 2.0% at 1.0 in. W.C. and cabinet air leakage less than 1.4% at 0.5 in. W.C. when tested in accordance with ASHRAE standard 193
- Approved for Manufactured Housing/Mobile Home applications (0401410 through 1202422) with accessory (order separately)
- Supports single speed cooling units

### Tougher

- Flame roll-out sensors standard
- Adjustable heating blower OFF delay
- Factory set blower ON delay
- RPJ® primary heat exchanger
- Stainless steel secondary heat exchanger
- High temperature limit control prevents overheating
- Direct ignition with Silicon Nitride ignitor
- High quality, corrosion-resistant, prepainted steel cabinet

### Easy-to-Install and Service

- Direct vent (2-pipe), single-pipe venting or ventilated combustion air
- 24 VAC humidifier terminal & electronic air cleaner terminal
- 35" (889mm) high, for ease of installation
- Simplified, factory installed internal condensate drain system
- Quarter turn knobs for easy door removal and secure attachment
- Factory shipped for natural gas, with propane gas conversion kits available
- Four position - upflow/downflow/horizontal (left/right) installation
- At least twelve different venting configurations
- Through the casing flue pipe for counterflow or horizontal applications with accessory (order separately)
- Concentric vent available
- Self diagnostics with super bright LED
- Slide out heat exchanger and blower assembly



\*Southern States Only

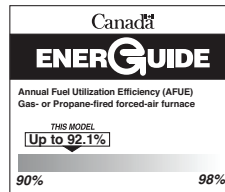

### Limited Warranty\*

- 20-year heat exchanger limited warranty
- 5-year parts limited warranty
  - With timely registration, an additional 5-year parts limited warranty

\* For residential applications only. See warranty certificate for complete details and restrictions, including warranty coverage for other applications.

### Unit Performance Data

Model Number	Heating Input (MBTUH)	Efficiency Range AFUE		Cooling Capacity CFM range @ .5 in wc (125 PA)	Operating Dimensions H x W x D (sq) in (mm)	Shipping Weight lbs (kg)
		Upflow/Hz	Downflow			
R92ESN0401410A	40,000	92.1%	92.1%	290 - 985	35 x 14-3/16 x 29-1/2 (889 x 361 x 750)	112 (50.8)
R92ESN0401712A	40,000	92.1%	92.1%	350 - 985	35 x 17-1/2 x 29-1/2 (889 x 445 x 750)	122.5 (55.6)
R92ESN0601412A	60,000	92.1%	92.1%	450 - 1035	35 x 14-3/16 x 29-1/2 (889 x 361 x 750)	122 (55.3)
R92ESN0601714A	60,000	92.1%	92.1%	535 - 1190	35 x 17-1/2 x 29-1/2 (889 x 445 x 750)	132 (59.9)
R92ESN0801716A	80,000	92.1%	92.1%	450 - 1365	35 x 17-1/2 x 29-1/2 (889 x 445 x 750)	142 (64.4)
R92ESN0802120A	80,000	92.1%	92.1%	940 - 1815	35 x 21 x 29-1/2 (889 x 533 x 750)	150 (68.0)
R92ESN1002120A	100,000	92.1%	92.1%	945 - 1850	35 x 21 x 29-1/2 (889 x 533 x 750)	160 (72.6)
R92ESN1202420A	120,000	92.1%	92.1%	805 - 1850	35 x 24-1/2 x 29-1/2 (889 x 622 x 750)	183 (83.0)

# 80% Gas Furnaces



*Low NOx units are designed for California installations and meet 40 ng/J NOx emissions. Can be installed in air quality management districts with a 40 ng/J NOx emissions requirement.*

# F80CTL

## 80% AFUE Variable-Speed, Two-Stage Gas Furnace

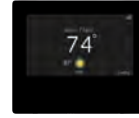

SYST0101CW  
Recommended  
(Sold separately)



TSTAT0201CW  
Recommended  
(Sold separately)



### Easier to Sell

- 80% AFUE
- Cabinet air leakage less than 2.0% at 1.0 in. W.C. and cabinet air leakage less than 1.4% at 0.5 in. W.C. when tested in accordance with ASHRAE standard 193
- Supports two-stage cooling units
- ION™ Communicating Control System
- Observer® Communicating Control System
- Flame roll-out sensors standard
- Category I venting
- Blocked vent switch
- Dehumidification feature in cooling
- 24 VAC humidifier terminal
- Electronic air cleaner terminal
- Low NOx units are designed for California installations and meet 40 ng/J NOx emissions. Can be installed in air quality management districts with a 40 ng/J NOx emissions requirement.

### Tougher

- Variable-speed ECM blower motor
- Adjustable heating blower OFF delay
- Factory set blower ON delay
- RPJ® aluminized steel heat exchanger
- High temperature limit control prevents overheating
- Direct ignition with Silicon Nitride ignitor
- One piece prepainted steel cabinet

### Quieter

- Two-stage heating runs in lower stage for longer for quieter operation
- Two-stage induced draft blower
- In-shot burners
- Insulated blower compartment

### Easy-to-Install and Service

- 33-1/3" (847mm) high, for ease of installation
- Quarter turn knobs for easy door removal and secure attachment
- Factory shipped for natural gas, with propane gas conversion kits available
- Four position - upflow/downflow/horizontal (left/right) installation
- Three position vent elbow capability
- Through the casing flue pipe for counterflow applications
- Common venting with other Category I appliances
- Masonry chimney adapter available
- Self diagnostics
- Slide out blower assembly

### Limited Warranty\*

- 10-year No Hassle Replacement limited™ warranty
- Lifetime heat exchanger limited warranty
- 5-year parts limited warranty - With timely registration, an additional 5-year parts limited warranty

\* For residential applications only, See warranty certificate for complete details and restrictions, including warranty coverage of other applications

### Unit Performance Data

Model Number	Heating Input (MBTUH)	Efficiency AFUE	Cooling Capacity CFM range @ .5 in. w.c. (125 PA)	Dimensions H x W x D Inches (Millimeters)	Shipping Wt. Lbs (Kg)
F80CTL0451712	44,000	80.0%	550 - 1345	33-1/3 x 17-1/2 x 29 (847 x 445 x 737)	126 (57)
F80CTL0701412	66,000	80.0%	485 - 1395	33-1/3 x 14-3/16 x 29 (847 x 360 x 737)	107 (49)
F80CTL0701716	66,000	80.0%	505 - 1375	33-1/3 x 17-1/2 x 29 (847 x 445 x 737)	126 (57)
F80CTL0702120	66,000	80.0%	790 - 2150	33-1/3 x 21 x 29 (847 x 533 x 737)	146 (66)
F80CTL0901716	88,000	80.0%	475 - 1595	33-1/3 x 17-1/2 x 29 (847 x 445 x 737)	126 (57)
F80CTL0902120	88,000	80.0%	730 - 2330	33-1/3 x 21 x 29 (847 x 533 x 737)	146 (66)
F80CTL1102120	110,000	80.0%	700 - 2155	33-1/3 x 21 x 29 (847 x 533 x 737)	152 (69)
F80CTL1352422	132,000	80.0%	690 - 2265	33-1/3 x 24-1/2 x 29 (847 x 622 x 737)	163 (74)





# N80VSL

## 80% AFUE Single-Stage Gas Furnace

### Easier to Sell

- 80% AFUE
- Single-stage gas valve
- Flame roll-out sensors standard
- Variable-speed, constant torque ECM blower motor
- Category I venting
- Supports two-stage cooling units
- Blocked vent switch
- Dehumidification feature in cooling
- Louvered door
- 24 VAC and 115 VAC humidifier terminal
- Electronic air cleaner terminal
- **N80ESL** – Low NOx units are designed for California installations and meet 40 ng/J NOx emissions. Can be installed in air quality management districts with a 40 ng/J NOx emissions requirement.
- Cabinet air leakage less than 2.0% at 1.0 in. W.C. and cabinet air leakage less than 1.4% at 0.5 in. W.C. when tested in accordance with ASHRAE standard 193

### Tougher

- Adjustable heating blower OFF delay
- Factory set blower ON delay
- RPJ® aluminized steel heat exchanger
- High temperature limit control prevents overheating
- Direct ignition with Silicon Nitride ignitor
- One piece prepainted steel cabinet

### Quieter

- In-shot burners
- Fully insulated cabinet

### Easy-to-Install and Service

- 33-1/3" (847mm) high, for ease of installation
- Quarter turn knobs for easy door removal and secure attachment
- Factory shipped for natural gas, with propane gas conversion kits available
- Four position – upflow/downflow/horizontal (left/right) installation
- Three position inducer elbow capability
- Through the casing flue pipe for counterflow applications
- Common venting with other Category I appliances
- Masonry chimney adapter available
- Self diagnostics
- Slide out blower assembly

### Limited Warranty\*

- 20-year heat exchanger limited warranty
- 5-year parts limited warranty – With timely registration, an additional 5-year parts limited warranty

\* For residential applications only, See warranty certificate for complete details and restrictions, including warranty coverage of other applications.

### Unit Performance Data

Model Number	Heating Input (MBTUH)	Upflow/Hz	Operating Dimensions H x W x D (sq) in (mm)	Shipping Weight lbs (kg)
N80VSL0451716A	44,000	80.0%	33-1/3 x 14-3/16 x 29 (847 x 360 x 737)	119 (54)
N80VSL0701716A	66,000	80.0%	33-1/3 x 17-1/2 x 29 (847 x 445 x 737)	120 (54)
N80VSL0702120A	66,000	80.0%	33-1/3 x 14-3/16 x 29 (847 x 360 x 737)	142 (64)
N80VSL0902120A	88,000	80.0%	33-1/3 x 17-1/2 x 29 (847 x 445 x 737)	140 (54)
N80VSL0902420A	88,000	80.0%	33-1/3 x 21 x 29 (847 x 533 x 737)	146 (66)
N80VSL1102422A	110,000	80.0%	33-1/3 x 17-1/2 x 29 (847 x 445 x 737)	161 (73)

# N80ESN, N80ESL

## 80% AFUE Single-Stage Gas Furnace



### Easier to Sell

- 80% AFUE
- Flame roll-out sensors standard
- Category I venting
- Blocked vent switch
- Louvered door
- 24 VAC and 115 VAC humidifier terminal
- Electronic air cleaner terminal
- **N80ESL** – Low NOx units are designed for California installations and meet 40 ng/J NOx emissions. Can be installed in air quality management districts with a 40 ng/J NOx emissions requirement.
- Cabinet air leakage less than 2.0% at 1.0 in. W.C. and cabinet air leakage less than 1.4% at 0.5 in. W.C. when tested in accordance with ASHRAE standard 193

### Tougher

- Adjustable heating blower OFF delay
- Factory set blower ON delay
- RPJ® aluminized steel heat exchanger
- High temperature limit control prevents overheating
- Direct ignition with Silicon Nitride ignitor
- One piece prepainted steel cabinet

### Quieter

- In-shot burners

### Easy-to-Install and Service

- 33-1/3" (847mm) high, for ease of installation
- Quarter turn knobs for easy door removal and secure attachment
- Factory shipped for natural gas, with propane gas conversion kits available
- Four position – upflow/downflow/horizontal (left/right) installation
- Three position inducer elbow capability
- Through the casing flue pipe for counterflow applications
- Common venting with other Category I appliances
- Masonry chimney adapter available
- Self diagnostics
- Slide out blower assembly

### Limited Warranty\*

- 20-year heat exchanger limited warranty
- 5-year parts limited warranty – With timely registration, an additional 5-year parts limited warranty

\* For residential applications only, See warranty certificate for complete details and restrictions, including warranty coverage of other applications.

### Unit Performance Data

Model Number	Heating Input (MBTUH)	Upflow/Hz	Cooling Capacity CFM range @ .5 in wc (125 PA)	Operating Dimensions H x W x D (sq) in (mm)	Shipping Weight lbs (kg)
N80ESN(L)0451412A	44,000	80.0%	415 – 1080	33-1/3 x 14-3/16 x 29 (847 x 360 x 737)	104 (47)
N80ESN(L)0451712A	44,000	80.0%	320 – 1215	33-1/3 x 17-1/2 x 29 (847 x 445 x 737)	119 (54)
N80ESN(L)0701412A	66,000	80.0%	315 – 1070	33-1/3 x 14-3/16 x 29 (847 x 360 x 737)	114 (52)
N80ESN(L)0701712A	66,000	80.0%	385 – 1005	33-1/3 x 17-1/2 x 29 (847 x 445 x 737)	120 (54)
N80ESN(L)0702116A	66,000	80.0%	775 – 1545	33-1/3 x 21 x 29 (847 x 533 x 737)	142 (64)
N80ESN(L)0901714A	88,000	80.0%	750 – 1210	33-1/3 x 17-1/2 x 29 (847 x 445 x 737)	131 (49)
N80ESN(L)0902116A	88,000	80.0%	845 – 1445	33-1/3 x 21 x 29 (847 x 533 x 737)	137 (62)
N80ESN(L)0902120A	88,000	80.0%	915 – 1980	33-1/3 x 21 x 29 (847 x 533 x 737)	140 (64)
N80ESN(L)0902420A	88,000	80.0%	845 – 1960	33-1/3 x 24-1/2 x 29 (847 x 622 x 737)	146 (66)
N80ESN(L)1102120A	110,000	80.0%	990 – 1715	33-1/3 x 21 x 29 (847 x 533 x 737)	146 (66)
N80ESN(L)1102420A	110,000	80.0%	820 – 2005	33-1/3 x 24-1/2 x 29 (847 x 622 x 737)	161 (73)
N80ESN(L)1352420A	132,000	80.0%	1025 – 1810	33-1/3 x 24-1/2 x 29 (847 x 622 x 737)	167 (76)
N80ESN(L)1552420A	154,000	80.0%	835 – 1965	33-1/3 x 24-1/2 x 29 (847 x 622 x 737)	168 (76)



# N80ESU

## 80% AFUE Single-Stage Gas Furnace

### Easier to Sell

- 80% AFUE
- Ultra-low Nox emissions - 14 nanograms/joule for use in California Air Quality Management Districts requiring 14 nanograms/joule or less emissions
- Four position - upflow/downflow/horizontal (left/right) installation (6 different vent options)
- Versatile venting for tight-fit applications
- Category I venting
- Cabinet air leakage less than 2.0% at 1.0 in. W.C. and cabinet air leakage less than 1.4% at 0.5 in. W.C. when tested in accordance with ASHRAE Standard 193

### Tougher

- ECM blower motor
- Discrete-tapped blower motor
- Stainless steel heat exchanger
- Pilot free, hot surface ignition
- High temperature limit control prevents overheating
- Blocked vent switch

### Easy-to-Install and Service

- 33-1/4" (843.9mm) high, for ease of installation
- Quarter turn knobs for easy door removal and secure attachment
- Factory shipped for natural gas
- Flexible installation: Upflow, Downflow, Horizontal
- Two position vent elbow capability
- Common venting with other Category I appliances
- Self diagnostics
- Slide out blower assembly

### Quieter

- Noise elimination combustion system
- Variable-speed inducer motor

### Limited Warranty\*

- 20-year heat exchanger limited warranty
- 10-year parts limited warranty with timely registration
- 5-year parts limited warranty if not registered within 90 days of original installation

\* For residential applications only. See warranty certificate for complete details and restrictions, including warranty coverage of other applications.

### Unit Performance Data

Model Number	Input (MBTUH)	Efficiency AFUE	Cooling Capacity CFM range @ .5 in wc (125 PA)	Operating Dimensions H x W x D (sq) in (mm)	Shipping Weight lbs (kg)
N80ESU0601716A	60,000	80.0%	940 - 1545	33-1/4 x 17-1/2 x 29 (844 x 445 x 737)	126 (57)
N80ESU0802120A	80,000	80.0%	815 - 1990	33-1/4 x 21 x 29 (844 x 533 x 737)	140 (64)

# R80ESN, R80ESL

## 80% AFUE Single-Stage Gas Furnace



### Easier to Sell

- 80% AFUE
- Flame roll-out sensors standard
- Category I venting
- Blocked vent switch
- Louvered door
- 24 VAC and 115 VAC humidifier terminal
- Electronic air cleaner terminal
- **R80ESL** – Low NOx units are designed for California installations and meet 40 ng/J NOx emissions. Can be installed in air quality management districts with a 40 ng/J NOx emissions requirement.
- Cabinet air leakage less than 2.0% at 1.0 in. W.C. and cabinet air leakage less than 1.4% at 0.5 in. W.C. when tested in accordance with ASHRAE standard 193

### Tougher

- Adjustable heating blower OFF delay
- Factory set blower ON delay
- RPJ® aluminized steel heat exchanger
- High temperature limit control prevents overheating
- Direct ignition with Silicon Nitride ignitor
- One piece prepainted steel cabinet

### Quieter

- In-shot burners

### Easy-to-Install and Service

- 33-1/3" (847mm) high, for ease of installation
- Quarter turn knobs for easy door removal and secure attachment
- Factory shipped for natural gas, with propane gas conversion kits available
- Four position – upflow/downflow/horizontal (left/right) installation
- Three position inducer elbow capability
- Through the casing flue pipe for counterflow applications
- Common venting with other Category I appliances
- Masonry chimney adapter available
- Self diagnostics
- Slide out blower assembly

### Limited Warranty\*

- 20 year heat exchanger limited warranty
- 5-year parts limited warranty – With timely registration, an additional 5-year parts limited warranty

\* For residential applications only, See warranty certificate for complete details and restrictions, including warranty coverage of other applications.

### Unit Performance Data

Model Number	Heating Input (MBTUH)	Upflow/Hz	Cooling Capacity CFM range @ .5 in wc (125 PA)	Operating Dimensions H x W x D (sq) in (mm)	Shipping Weight lbs (kg)
R80ESN(L)0451412A	44,000	80.0%	415 – 1080	33-1/3 x 14-3/16 x 29 (847 x 360 x 737)	104 (47)
R80ESN(L)0451712A	44,000	80.0%	320 – 1215	33-1/3 x 17-1/2 x 29 (847 x 445 x 737)	119 (54)
R80ESN(L)0701412A	66,000	80.0%	315 – 1070	33-1/3 x 14-3/16 x 29 (847 x 360 x 737)	114 (52)
R80ESN(L)0701712A	66,000	80.0%	385 – 1005	33-1/3 x 17-1/2 x 29 (847 x 445 x 737)	120 (54)
R80ESN(L)0702116A	66,000	80.0%	775 – 1545	33-1/3 x 21 x 29 (847 x 533 x 737)	142 (64)
R80ESN(L)0901714A	88,000	80.0%	750 – 1210	33-1/3 x 17-1/2 x 29 (847 x 445 x 737)	131 (49)
R80ESN(L)0902116A	88,000	80.0%	845 – 1445	33-1/3 x 21 x 29 (847 x 533 x 737)	137 (62)
R80ESN(L)0902120A	88,000	80.0%	915 – 1980	33-1/3 x 21 x 29 (847 x 533 x 737)	140 (64)
R80ESN(L)0902420A	88,000	80.0%	845 – 1960	33-1/3 x 24-1/2 x 29 (847 x 622 x 737)	146 (66)
R80ESN(L)1102120A	110,000	80.0%	990 – 1715	33-1/3 x 21 x 29 (847 x 533 x 737)	146 (66)
R80ESN(L)1102420A	110,000	80.0%	820 – 2005	33-1/3 x 24-1/2 x 29 (847 x 622 x 737)	161 (73)
R80ESN(L)1352420A	132,000	80.0%	1025 – 1810	33-1/3 x 24-1/2 x 29 (847 x 622 x 737)	167 (76)

# Accessories

## Gas Furnaces

Model Number	Description	Used with Models
<b>Filter Kits</b>		
NAHB00501FF*	Bottom return filter rack 14"	All 14" F8, N8, R8, F9, N9, R9
NAHB00601FF*	Bottom return filter rack 17"	All 17" F8, N8, R8, F9, N9, R9
NAHA00506FB†	Washable filter, 1-inch 16 x 25" (6 pack)	All 17" and 14" F8, N8, R8, F9, N9, R9
NAHB00701FF*	Bottom return filter rack 21"	All 21" F8, N8, R8, F9, N9, R9
NAHB00801FF*	Bottom return filter rack 24"	All 24" F8, N8, R8, F9, N9, R9
NAHA00706FB	Washable filter, 1-inch 24 x 25" (6 pack)	All 21" and 24" F8, N8, R8, F9, N9, R9
NAHB00501FF	External side return filter rack 16 x 25"	All F8, N8, R8, F9, N9, R9

\* Washable filter included with rack † Suitable for side return filter rack and 17" external bottom filter rack

Model Number	Description	Used with Models
<b>Combustible Floor Subbases</b>		
NAHA01101SB	Combustible Floor Subbase (not required when evaporator coil case is used)	Downflow F8, N8, R8, F9, N9, R9
<b>High Altitude Kit and Pressure Switch</b>		
NAHA00201HL	High Altitude Kit	F80CTL
<b>Vent Kits</b>		
NAHB00301VC	Downflow vent guard (not required when vent is routed through cabinet)	All F8, N8, R8 furnaces in the downflow application
NAHA00101VC	Internal Vent Kit (through the cabinet)	All F9, N9, R9 furnaces
NAHA00301VT	2" Direct Vent Termination Bracket	All F9, N9, R9 furnaces (100k or smaller sizes)
NAHA00401VT	3" Direct Vent Termination Bracket	All F9, N9, R9 furnaces (60k and larger)
NAHA002CV	2" (50.8 mm) Concentric Vent Kit allows single wall penetration for two-pipe direct vent applications (90+)	F9, N9, R9 furnaces (100k or smaller sizes)
NAHA001CV	3" (76.2 mm) Concentric Vent Kit allows single wall penetration for two-pipe direct vent applications (90+)	F9, N9, R9 furnaces (60k or larger sizes)
NAHA00101CK	Inlet Air Pipe Coupling for polypropylene vent systems	All F9, N9, R9 furnaces
<b>Masonry Chimney Adapter</b>		
NAHA00301DH	Chimney Adapter Kit 5"	F8, N8, R8 Greater than or equal to 135,000 Btuh
NAHA00401DH	Chimney Adapter Kit 4"	F8, N8, R8 - Less than 135,000 Btuh
<b>Freeze Protection</b>		
NAHA00101HH	Condensate drain line heat tape	All F9, N9, R9 furnaces
NAHA00201HH	Condensate freeze trap with heat pad	All F9, N9, R9 furnaces
<b>Horizontal Installation Kit</b>		
NAHA00101HV	Trap Grommet (direct vent application only)	All F9, N9, R9 furnaces
<b>Drain Accessory Kit</b>		
NAHA00110DA	1/2" CPVC to 3/4" PVC (10 pack)	All F9, N9, R9 furnaces
NAHA00101CT	External Drain Kit	All F9, N9, R9 furnaces
<b>Motor Simulator Kit</b>		
NAHA00101MS	Motor Simulation Kit	All F96CMN, F96CTN furnaces
<b>Lower Amp Kit</b>		
NAHA00101PC	Lower Amp/Power Choke Kit for 5T ECM-PWM	F96VTN, 802120A4, 1002120A4

# Accessories

## Gas Furnaces

Model Number	Description	Used with Models
<b>Twining Kit</b>		
AGATWNDTE01A	Allows operation of two identical size model furnaces.	N95, R95 (select sizes)
AGATWNPME01A	Allows operation of two identical size model furnaces.	F96VTN (select sizes)
<b>Gas Conversion Kits</b>		
<b>Natural Gas to Propane Gas</b>		
AGAGC9NPS01A	Natural gas to propane conversion kit for condensing furnaces. Allows field conversion to propane gas.	All F9, N9, R9 furnaces (except 26k BTU sizes)
AGAGC8NPS01A	Natural gas to propane conversion kit for non-condensing furnaces. Allows field conversion to propane gas.	All F8, N8, R8 furnaces
AGAGCANPLO1A	Natural gas to propane conversion kit for low capacity furnaces. Allows field conversion to propane gas.	All 26k BTU sizes of N9, R9 furnaces
<b>Mobile Home Conversion Kit</b>		
NAHC0101MH	Single-stage conversion kit	N9, R9 40,000 to 120,000 BTU Models
<b>Propane Gas to Natural Gas</b>		
AGAGC9PNS01A	Propane to natural gas conversion kit. Allows field conversion to natural gas.	All F9, N9, R9 furnaces (except 26k BTU sizes)
AGAGC8PNS01A	Propane to natural gas conversion kit. Allows field conversion to natural gas.	All F8, N8, R8 furnaces
AGAGCAPNLO1A	Natural gas to propane conversion kit. Allows field conversion to natural gas.	All 26k BTU size of N9, R9 furnaces
<b>Neutralizer Kit</b>		
NAHA001NK	Condensate neutralizer kit for condensing gas furnaces.	All F9, N9, R9 furnaces if required
<b>Coil Adapter</b>		
NAHB00101CA	Coil Adapter Kit with no offset	All F9, N9, R9 furnaces
NAHB00201CA	Coil Adapter Kit with single offset	All F9, N9, R9 furnaces
NAHB00301CA	Coil Adapter Kit with double offset	All F9, N9, R9 furnaces
<b>Return Air Base (Upflow Applications)</b>		
NAHA01401RA	Return Air Kit 14.2" Wide	All F9, N9, R9 furnaces
NAHA01701RA	Return Air Kit 17.5" Wide	All F9, N9, R9 furnaces
NAHA02101RA	Return Air Kit 21" Wide	All F9, N9, R9 furnaces
NAHA02401RA	Return Air Kit 24.5" Wide	All F9, N9, R9 furnaces
AGABLRJMP10A	Blower Speed Tap Jumper Kit (10 piece)	All sizes of N80E, R80E, N95E, N92E, R95E, R92E

(A)=Series A, (B)=Series B, (C)=Series D and (D)=Series D

# Oil Furnaces



# OUF

## Hi-Boy Upflow Oil Furnace



Available in Canada Only

### Features

- Fan control switch for continuous low speed
- Accessory terminals pre-wired for easy add-on electronic air cleaner and power humidifier
- Air conditioning ready for easy add-on
- Large external front clean out for easy cleaning
- Clean out sealed from blower compartment (no soot to spread)
- Easy access control panel
- Sight glass/view port
- Furnaces available with your choice of high-efficiency Riello or Beckett burners (Burners ordered and shipped separately)
- Test ports factory installed to provide efficient access for set-up and service
- Easy access heat exchanger manufactured from heavy gauge steel
- Multi-speed direct drive motors permanently lubricated for long life performance
- Heavy-duty insulated cabinet for quiet operation
- Approved for 1" (25mm) clearance to combustibles for tight installations
- Ceramic combustion chamber withstands temperature of 2600° F (1427° C) with unique self aligning design
- Precision balanced blower ensures quiet, efficient air distribution
- Raised cabinet base allows air to circulate under the cabinet, eliminates dampness
- Approved chimney or direct vent applications
- Efficient AFUE up to 86.1% Canada, 84.8% US
- Front flue (breach)

### Warranty\*

- Lifetime heat exchanger limited warranty with timely registration
- Five-year parts limited warranty
  - With timely registration, an additional five-year parts limited warranty

\* Applies to original purchaser/homeowner, some limitations may apply. See warranty certificate for complete details.

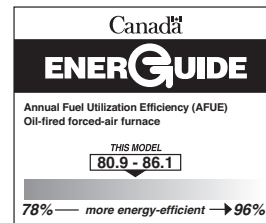

ONLY applies to applications in Canada where the furnace is installed in the conditioned space, per sections 5.35.1.2 and 4.7.1.1 of CSA standard B212 dated October 2000.

### Unit Performance Data

Model Number	Input (MBTUH)	Efficiency AFUE		Cooling Capacity @ .5 in wc (125 Pa)	Dimensions H x W x D* (sq) in (mm)	Operating Weight lbs (kg)
		Canada	US			
OUF105A12C	70,000 - 105,000	80.9 - 86.1	79.4 - 84.8	2 - 3 ton	48 x 21 x 23.4 (1219 x 533 x 594)	200 (91)
OUF160B18C	119,000 - 159,600	81.3 - 85.4	80.0 - 84.3	3.5 - 5 ton	58-1/4 x 25 x 27.4 (1480 x 635 x 696)	248 (112)

\*Depth without the burner.



# OLF, OLR

## Lo-Boy Upflow Oil Furnace



Available in Canada Only

### Features

- Fan control switch for continuous fan operation
- Accessory terminals pre-wired for easy add-on electronic air cleaner and power humidifier
- Air conditioning ready for easy add-on
- Large external front clean out for easy cleaning
- Clean out sealed from blower compartment (no soot to spread)
- Easy access control panel
- Sight glass/view port (some models only)
- Furnaces available with your choice of high-efficiency Riello or Beckett burners (Burners ordered and shipped separately)
- Easy access heat exchanger manufactured from heavy gauge steel
- Multi-speed direct drive motors permanently lubricated for long life performance
- Heavy-duty insulated cabinet for quiet operation
- Approved for 1" (25mm) clearance to combustibles for tight installations
- Ceramic combustion chamber withstands temperature of 2600° F (1427° C) with unique self aligning design
- Precision balanced blower ensures quiet, efficient air distribution
- Raised cabinet base allows air to circulate under the cabinet, eliminates dampness
- Approved chimney or some direct vent applications with accessories
- Efficient AFUE up to 85.7% Canada, 85.1% US
- OLF - Front flue (breach)
- OLR - Rear flue (breach)

### Warranty\*

- Lifetime heat exchanger limited warranty with timely registration
- Five-year parts limited warranty
  - With timely registration, an additional five-year parts limited warranty

\* For residential applications only. See warranty certificate for complete details and restrictions, including warranty coverage for other applications.

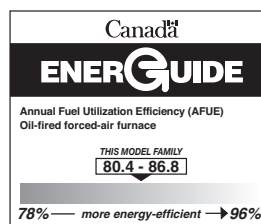

ONLY applies to applications in Canada where the furnace is installed in the conditioned space, per sections 5.35.1.2 and 4.7.1.1 of CSA standard B212 dated October 2000.

### Unit Performance Data

Model Number	Input (MBTUH)	Efficiency AFUE		Cooling Capacity @ .5 in wc (125 Pa)	Dimensions H x W x D* (sq) in (mm)	Operating Weight lbs (kg)
		Canada	US			
OLR105A12D	70,000 - 105,000	83.7 - 86.8	80.5 - 85.7	1.5 - 3 ton	32 x 21 x 43.4 (813 x 533 x 1102)	200 (91)
OLF105A12C	70,000 - 105,000	81.9 - 85.9	78.7 - 86.0	1.5 - 3 ton	32 x 21 x 43.4 (813 x 533 x 1102)	207 (94)
OLR160B20C	119,000 - 159,600	80.4 - 85.1	78.7 - 83.1	1.5 - 5 ton	40 x 25 x 51.4 (1016 x 635 x 1306)	235 (107)

\*Depth without the burner.

# OMF

## Hi-Boy Multi-Position Oil Furnace



### Features

- Stainless steel, heavy gauge heat exchanger quickly transfers heat to the ambient air
- Multi-position, four-way multi-poise unit that opens up installation possibilities
- Low profile – OMF098 is 40-3/4" (1035mm) high, OMF112 is 41-1/2" (1054 mm) high, OMF 154 is 47-7/8" (1216 mm) high
- Sound attenuator, integrated inside secondary heat exchanger
- High density acoustic wool dampens combustion sound
- Choice of high static pressure oil burners: Beckett AFG and NX, Riello 40 (burners must be ordered separately)
- Inspection port external for easy access and sealed, adjust combustion parameters and simplify inspections
- Approved for chimney vent and sealed combustion installations
- High quality, high-gloss baked finish
- Efficient AFUE up to 87.0% Canada, 86.4% US
- Front flue (breach)

### Warranty\*

- Lifetime heat exchanger limited warranty with timely registration
- Five-year parts limited warranty
  - With timely registration, an additional five-year parts limited warranty

\* For residential applications only. See warranty certificate for complete details and restrictions, including warranty coverage for other applications.

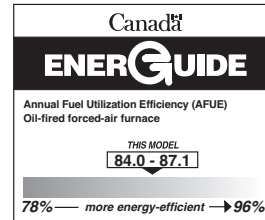

ONLY applies to applications in Canada where the furnace is installed in the conditioned space, per sections 5.35.1.2 and 4.7.1.1 of CSA standard B212 dated October 2000.

### Unit Performance Data

Model Number	Input (MBTUH)	Efficiency AFUE		Cooling Capacity @ .5 in wc (125 Pa)	Dimensions H x W x D* (sq) in (mm)	Operating Weight lbs (kg)
		Canada	US			
OMF098J10B	70,000 - 98,000	84.0 - 87.0	83.3 - 86.4	2.5 ton	40-3/4 x 16-7/8 x 21-1/2 (1035 x 429 x 546)	125 (57)
OMF112K14A	95,200 - 112,000	85.5 - 87.1	85.3 - 85.8	3.5 ton	41-1/2 x 21-3/4 x 25-3/4 (1054 x 553 x 654)	153 (70)
OMF154L20A	126,000 - 154,000	85.3† - 87.0†	85.0† - 86.1†	5 ton	47-7/8 x 28-1/2 x 25 (1216 x 724 x 635)	200 (90)

\* Depth without the burner

† Meets ENERGY STAR® Guidelines (Only specific firing rates meet the ENERGY STAR guidelines).



# OMV

## Hi-Boy Multi-Position, Variable-Speed Oil Furnace

### Features

- Stainless steel, heavy gauge heat exchanger quickly transfers heat to the ambient air
- Multi-position, four way multi-poise unit that opens-up installation possibilities
- Low profile - OMV098 is 40-3/4" (1035 mm) high, OMV112 is 41-1/2" (1054 mm) high, OMF154 is 47-7/8" (1216 mm) high
- Sound attenuator, integrated inside secondary heat exchanger
- High density acoustic wool dampens combustion sound
- Variable-speed blower ECM motor that provides true constant CFM capabilities
- Dehumidification with variable-speed ECM motor allows modulation of blower speed to better extract humidity
- Choice of high static pressure oil burners: Beckett AFG and NX, Riello 40 (Burners must be ordered separately)
- Inspection port/clean outs external for easy access and sealed, adjust combustion parameters and simplify inspections parameters and perform inspections easily with this sealed, spring-loaded access port
- Approved for chimney vent and sealed combustion installations
- High quality, high-gloss baked finish
- Efficient AFUE up to 86.7% Canada, 86.3% US
- Front flue (breach)

### Warranty\*

- 10-year No Hassle Replacement™ limited warranty
- Lifetime heat exchanger limited warranty with timely registration
- Five-year parts limited warranty
  - With timely registration, an additional five-year parts limited warranty

\* For residential applications only.  
See warranty certificate for complete details and restrictions, including warranty coverage for other applications.

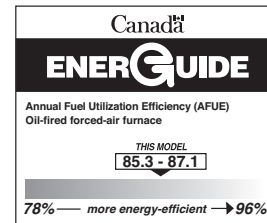

ONLY applies to applications in Canada where the furnace is installed in the conditioned space, per sections 5.35.1.2 and 4.7.1.1 of CSA standard B212 dated October 2000.

### Unit Performance Data

Model Number	Input (MBTUH)	Efficiency AFUE		Cooling Capacity @ .5 in wc (125 Pa)	Dimensions H x W x D* (sq) in (mm)	Operating Weight lbs (kg)
		Canada	US			
OMV098J12B	70,000 - 98,000	87.0†	85.0† - 86.4†	3 ton	40-3/4 x 16-7/8 x 21-1/2 (1035 x 429 x 546)	125 (57)
OMV112K14A	95,200 - 112,000	85.5† - 87.1†	85.3† - 85.8†	3.5 ton	41-1/2 x 21-3/4 x 25-3/4 (1054 x 553 x 654)	153 (70)
OMV154L20A	126,000 - 154,000	85.3† - 87.0†	85.0† - 86.3	5 ton	47-7/8 x 28-1/2 x 25 (1216 x 724 x 635)	200 (90)

\* Depth without the burner

† Meets ENERGY STAR® Guidelines (Only specific firing rates meet the ENERGY STAR guidelines).

# OLR

## Lo-Boy Upflow Oil Furnace



### Features

- Stainless steel, heavy gauge heat exchanger quickly transfers heat to the ambient air
- Multi-speed direct drive motors permanently lubricated for long life performance
- Easy access control panel
- Low profile OLR098 is 33-3/4" (857mm) high, OLR112 is 33-3/4" (857mm) high, OLR154 is 39-1/4" (997mm) high
- Sound attenuator, high density acoustic wool dampens combustion sound
- Choice of high static pressure oil burners: Beckett AFG and NX, Riello 40 (burners must be ordered separately)
- Inspection port external for easy access and sealed, adjust combustion parameters and simplify inspections
- Accessories included, barometric draft regulator, internal filter rack and air filter
- High quality, high-gloss baked finish
- Efficient AFUE up to 87.0% Canada, 86.4% US
- Approved for chimney vent and sealed combustion installations

### Warranty\*

- Lifetime heat exchanger limited warranty with timely registration
- Five-year parts limited warranty
  - With timely registration, an additional five-year parts limited warranty

\* For residential applications only. See warranty certificate for complete details and restrictions, including warranty coverage for other applications.

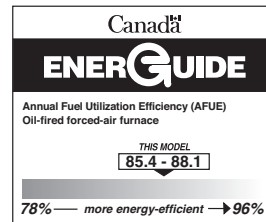

ONLY applies to applications in Canada where the furnace is installed in the conditioned space, per sections 5.35.1.2 and 4.7.1.1 of CSA standard B212 dated October 2000.

### Unit Performance Data

Model Number	Input (MBTUH)	Efficiency AFUE		Cooling Capacity @ .5 in wc (125 Pa)	Dimensions H x W x D* (sq) in (mm)	Operating Weight lbs (kg)
		Canada	US			
OLR098A12A	77,000 - 98,000	85.4 - 87.9	85.0 - 86.9	3 ton	33-3/4 x 21 x 47 (857 x 533 x 1194)	175 (79)
OLR112A16A	95,200 - 112,000	86.4 - 88.1	85.9 - 87.2	4 ton	33-3/4 x 21 x 48 (857 x 533 x 1219)	195 (89)
OLR154F20A	126,000 - 154,000	86.1 - 87.7	85.5 - 87.5	5 ton	39-1/4 x 24-7/8 x 52 (997 x 632 x 1320)	270 (123)

\* Depth without the burner



# OLR 210

## Lo-Boy Oil Furnace

Available in Canada Only

### Features

- Fan control switch for continuous low speed
- Large external front clean out for easy cleaning
- Clean out sealed from blower compartment (no soot to spread)
- Easy access control panel
- Sight glass/view port
- Furnaces are available with your choice of high-efficiency Riello or Beckett burners (burners ordered and shipped separately)
- Easy access heat exchanger manufactured from heavy gauge steel
- Multi-speed direct drive motors permanently lubricated for long life performance
- Heavy-duty insulated cabinet for quiet operation
- Precision balanced blower ensures quiet, efficient air distribution
- Raised cabinet base allows air to circulate under the cabinet, eliminates dampness
- Efficient AFUE up to 86.7% Canada, 85.4% US
- OLR - Rear flue (breach)

### Warranty\*

- Lifetime heat exchanger limited warranty with timely registration
- Five-year parts limited warranty
  - With timely registration, an additional five-year parts limited warranty

\* For residential applications only. See warranty certificate for complete details and restrictions, including warranty coverage for other applications.

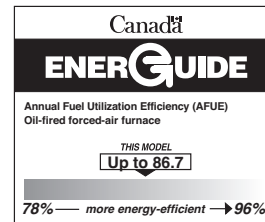

ONLY applies to applications in Canada where the furnace is installed in the conditioned space, per sections 5.35.1.2 and 4.7.1.1 of CSA standard B212 dated October 2000.

### Unit Performance Data

Model Number	Input (MBTUH)	Efficiency AFUE		Cooling Capacity @ .5 in wc (125 Pa)	Dimensions H x W x D* (sq) in (mm)	Operating Weight lbs (kg)
		Canada	US			
OLR210F19C	168,000 - 210,000	84.6 - 86.7	83.1 - 85.4	5 ton	36-1/2 x 20-1/4 x 50-5/8 (918 x 533 x 1286)	240 (109)

\* Depth without the burner

# OLR350

## Lo-Boy Upflow Oil Furnace

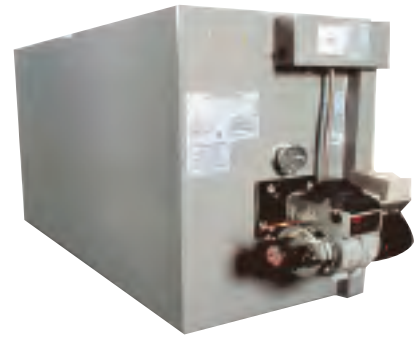

### Features

- Fan control switch for continuous speed
- Large external rear clean out for easy cleaning
- Clean out sealed from blower compartment (no soot to spread)
- Easy access control panel
- Sight glass/view port
- Furnaces are available with your choice of high-efficiency Riello or Beckett burners (burners ordered and shipped separately)
- Easy access heat exchanger manufactured from heavy gauge steel
- Multi-speed direct drive motors permanently lubricated for long life performance
- Heavy-duty insulated cabinet for quiet operation
- Precision balanced blower ensures quiet, efficient air distribution
- Raised cabinet base allows air to circulate under the cabinet, eliminates dampness
- Efficient AFUE up to 81.5%
- Not air conditioning ready
- Rear flue (breech)

### Warranty\*

- Lifetime heat exchanger limited warranty with timely registration
- Five-year parts limited warranty
  - With timely registration, an additional five-year parts limited warranty

\* For residential applications only. See warranty certificate for complete details and restrictions, including warranty coverage for other applications.

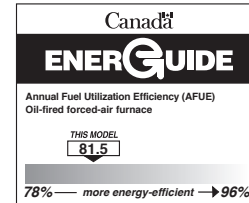

### Unit Performance Data

Model Number	Input (MBTUH)	Efficiency AFUE		Dimensions H x W x D* (sq) in (mm)	Operating Weight lbs (kg)
		Canada	US		
OLR350H28B	245,000 - 350,800	81.5	81.5	46-7/8 x 26 x 66-7/8 (1191 x 660 x 1699)	400 (181)

\* Depth without the burner.

### Build to Order Only



### Features

- Stainless steel, heavy gauge heat exchanger quickly transfers heat to the ambient air
- Variable-speed ECM motor that provides true constant CFM capabilities
- Fan control switch for continuous operation
- Easy access control panel
- Low profile OLV098 is 33-3/4" (857 mm) high, OLV112 is 33-3/4" (857 mm) high, OLV154 is 39-1/4" (997mm) high
- Sound attenuator, high density acoustic wool dampens combustion sound
- Choice of high-efficiency, high-static pressure oil burners Riello or Beckett AFG and NX burners (burners ordered and shipped separately)
- Inspection port external for easy access and sealed, adjust combustion parameters and simplify inspections
- Accessories included, barometric draft regulator, internal filter rack and air filter
- High quality, high-gloss baked finish
- Efficient AFUE up to 88.1% Canada, 87.5% US
- Approved for chimney vent and sealed combustion installations

### Warranty\*

- 10-year No Hassle Replacement™ limited warranty
- Lifetime heat exchanger limited warranty with timely registration
- Five-year parts limited warranty
  - With timely registration, an additional five-year parts limited warranty

\* Applies to original purchaser/homeowner, some limitations may apply. See warranty certificate for complete details.

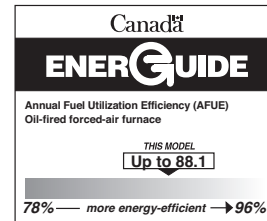

ONLY applies to applications in Canada where the furnace is installed in the conditioned space, per sections 5.35.1.2 and 4.7.1.1 of CSA standard B212 dated October 2000.

### Unit Performance Data

Model Number	Input (MBTUH)	Efficiency AFUE		Cooling Capacity @ .5 in wc (125 Pa)	Dimensions H x W x D* (sq) in (mm)	Operating Weight lbs (kg)
		Canada	US			
OLV098A12A	70,000 - 98,000	85.4† - 87.0†	85.0† - 86.9†	3 ton	33-3/4 x 21 x 47 (857 x 533 x 1194)	175 (80)
OLV112A16A	81,100 - 112,000	86.4† - 88.1†	85.9† - 87.2†	4 ton	33-3/4 x 21 x 48 (857 x 533 x 1219)	195 (89)
OLV154F20A	107,700 - 154,000	86.1† - 87.7†	85.5† - 87.5†	5 ton	39-1/4 x 27-7/8 x 52 (997 x 632 x 1320)	270 (123)

\* Depth without the burner.

† Meets ENERGY STAR® Guidelines

# OTF210

## Upflow/Horizontal Oil Furnace



### Features

- Fan control switch for continuous speed
- Large external rear clean out for easy cleaning
- Clean out sealed from blower compartment (no soot to spread)
- Easy access control panel
- Sight glass/view port
- Furnaces are available with your choice of high-efficiency Riello or Beckett burners (burners ordered and shipped separately)
- Easy access heat exchanger manufactured from heavy gauge steel
- Multi-speed direct drive motors permanently lubricated for long life performance
- Heavy-duty insulated cabinet for quiet operation
- Precision balanced blower ensures quiet, efficient air distribution
- Raised cabinet base allows air to circulate under the cabinet, eliminates dampness
- Approved chimney vent applications
- Efficient AFUE up to 86.3% Canada, 85.0% US
- Air conditioning ready
- Front flue (breach)

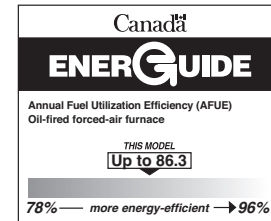

ONLY applies to applications in Canada where the furnace is installed in the conditioned space, per sections 5.35.1.2 and 4.7.1.1 of CSA standard B212 dated October 2000.

### Unit Performance Data

Model Number	Input (MBTUH)	Efficiency AFUE		Cooling Capacity @ .5 in wc (125 Pa)	Dimensions H x W x D* (sq) in (mm)	Operating Weight lbs (kg)
		Canada	US			
OTF210G21B	68,000 - 210,000	84.4 - 86.3	82.9 - 85.0	5 ton	52-3/4 x 24-1/4 x 34 (1340 x 616 x 864)	250 (113)

\* Depth without the burner



# Accessories

## Oil Furnaces

Model Number	Description	Used with Models
<b>Oil Burners</b>		
N01F034	Riello 40-BF3 Oil Burner for 5" Breech Models (Direct)	OLF105, OLR105, OUF105
N01F035	Riello 40-BF5 Oil Burner (Direct)	OLR160
N01F040	Riello 40-F5 Oil Burner	OTF210
N01F041	Riello 40 Oil Burner	OLR350
N01F049	Riello 40-F3 Oil Burner for 5" Breech Models (Chimney)	OLF105, OLR105, OUF105
N01F050	Riello 40-F5 Oil Burner for 6" Breech Models (Chimney)	OLR160
N01F051	Riello Oil Burner (Chimney)	OMF112, OMV112, OLR112, OLV112
N01F052	Riello Oil Burner (Direct)	OMF112, OMV112, OLR112, OLV112
N01F053	Riello Oil Burner (Chimney)	OLR154, OLV154
N01F054	Riello (Chimney Venting)	OMF098, OMV098, OLR098, OLV098
N01F055	Riello Oil Burner (Direct)	OMF098, OMV098, OLR098, OLV098
N01F056	Riello Oil Burner (Direct)	OLR154, OLV154
N01J038	Beckett AF11-85 Oil Burner for 5" Breech Models (Direct Vent)	OLF105, OLR105, OUF105
N01J039	Beckett AFG-F3 Oil Burner for 6" Breech Models (Chimney)	OLR160
N01J040	Beckett AFG-F0 Oil Burner for 5" Breech Models (Chimney)	OLF105, OLR105, OUF105
N01J041	Beckett AF11-150 Oil Burner for 6" Breech Models (Direct Vent)	OLR160
N01J045	Beckett AFG-F6 Oil Burner (Shipped with Nozzle 1.25 - 70W)	OTF210
N01J046	Riello 40 Oil Burner	OLR350
N01J050	Beckett NX Oil Burner	OMF098, OLR098, OLV098, OMV098
N01J052	Beckett NX Oil Burner	OMF112, OLR112, OLV112, OMV112
N01J053	Beckett Oil Burner (Chimney or Direct)	OLR154, OLV154, OMF154, OMV154
<b>Nozzles</b>		
N03F014	Nozzle, Oil Burner, Delavan, 0.50 GPH/60° A	OLR105, OLF105, OUF105, OMF098, OMV098, OLR098, OLV098
N03F015	Nozzle, Oil Burner, Delavan, 0.50 GPH/70° A	OLR105, OLF105, OUF105, OMF098, OMV098, OLR098, OLV098, OMF112, OMV112
N03F018	Nozzle, Oil Burner, Delavan, 0.40 GPH/70° A Riello	OMF098, OMV098
N03F027	Nozzle, Oil Burner, Delavan, 0.40 GPH/70° A Beckett	OMF098, OMV098, OLF105, OLR105
N03G010	Nozzle, Oil Burner, Delavan, 0.50 GPH/60° W	OLF105, OLR105, OUF105
N03G011	Nozzle, Oil Burner, Delavan, 0.60 GPH/60° W	OLF105, OLR105, OUF105, OLF140
N03G012	Nozzle, Oil Burner, Delavan, 1.00 GPH/70° W	OLR350, OTF210, OLF140, OLR210
N03G013	Nozzle, Oil Burner, Delavan, 1.10 GPH/70° W	OTF210, OLR210
N03H001	Nozzle, Oil Burner, Delavan, 1.00 GPH/70° B	OLR160
N03H008	Nozzle, Oil Burner, Delavan, 0.85 GPH/70° B	OLR160
N03H013	Nozzle, Oil Burner, Delavan, 0.75 GPH/70° B	OLR160
N03H014	Nozzle, Oil Burner, Delavan, 0.60 GPH/70° B	OUF105, OLR105, OLF105

# Accessories

## Oil Furnaces

Model Number	Description	Used with Models
<b>Vestibule Kits</b>		
LBVEST1M	Vestibule Kit for 5" Breech Low Boy Models	OLF105, OLR105, NOLF105
LBVEST2M	Vestibule Kit for 6" Breech Low Boy Models	OLR160
HBVEST1M	Vestibule Kit for 5" Breech High Boy Models	OUR105
<b>Vent Terminal Kits</b>		
VTK1	Vent Terminal Kit for 5" Breech Models	OLF105, OLR105, OUF105
VTK2	Vent Terminal Kit for 6" Breech Models	OLR160
IFV323	3" x 20' (76 mm x 7 m) Insulated Flex Vent for 5" Breech Models	OLF105, OLR105, OUF105
IFV415	4" x 15' (102 mm x 4.6 m) Insulated Flex Vent for 6" Breech Models	OLR160
IFV423	4" x 20' (102 mm x 7 m) Insulated Flex Vent for 6" Breech Models	OLR160
IFV508	5" x 10' (127 mm x 2.4 m) Insulated Flex Vent for 8" Breech Models	OLR154, OLV154, OMF154, OMV154
IFV520	5" x 20' (127 mm x 6 m) Insulated Flex Vent for 20' Breech Models	OLR154, OLV154, OMF154, OMV154
IFV09820	4" x 20' (102 mm x 6 m) Insulated Flex Vent for 4" Breech Models	OMF098, OMV098, OLR098, OLV098, OLR112, OLV112, OMF112, OMV112
<b>Floor Base</b>		
DFB102	Downflow Subbase	OMF098, OMV098
DFB103	Downflow Subbase	OMF112, OMV112
DFB104	Downflow Subbase	OMF154, OMV154
FRB101	Floor Return Base	OMF098, OMV098
<b>Coil Adapter</b>		
OCA20	Oil Coil Adapter (Cased Coil Adapter, (20" x 20"))	OLR105, OLF105, OUF105, NOLF105
OCA24	Oil Coil Adapter (Cased Coil Adapter, (24" x 24"))	OLR160
<b>Additional Accessories</b>		
B30083	External Filter Rack 20" x 20"	OUF105
CAS2B	Outside Air Intake for NO1J040	OLF105, OLR105, OUF105, OLR160
CAD1	25' Flexible Air Duct for CAS2B	OLF105, OLR105, OUF105, OLR160
Z06F007	Draft Regulator	OTF210
C7001025	Riello Two-Pipe Change Over Kit	OLF105, OLR105
Z08F001+	7 Micron Media Filter and Head	OLF, OLR, OCF, OUF
Z08F004+	7 Micron Media Filter	OLF, OLR, OCF, OUF

+ Must be ordered from Service Parts

# Fan Coils, Evaporator Coils and Blower Coils



# FCM4X

## Fan Coils with Communicating Control System

2 – 5 Tons

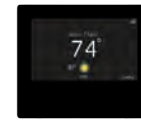

Recommended  
(Sold separately)



### Features

- Easier troubleshooting, providing faster service and repair
- Multi-position installation
- Communicating, self configuring when used with Observer Communicating Wall Control or Ion™ System Control
- Aluminum tube, aluminum fin evaporator coil
- Bi-flow hard-shutoff R-410A TXV metering device
- HUD approved for manufactured housing
- Sweat connections
- Primary and secondary brass drain connections
- Energy-efficient variable-speed ECM Motor
- Ultra-low power consumption during fan only operation
- High duct static capability
- Pre-painted galvanized sheet metal cabinet insulation with vapor barrier
- Cabinet construction designed to prevent cabinet sweating
- Meets requirements of a 2% cabinet leakage rate when tested at 1-inch water column of static pressure
- Modular cabinet on 5-ton model
- 208/230-1-60 supply voltage
- Multiple electrical entry for application flexibility
- Low voltage terminal strip
- Easy plug connection provided for quick installation of accessory heater packages
- Factory supplied washable filter easily removed  
- no tools required

### Warranty\*

- 10-year No Hassle Replacement™ limited warranty
- Five-year parts limited warranty  
– With timely registration, an additional five-year parts limited warranty

\* For residential applications only.  
See warranty certificate for complete details and restrictions, including warranty coverage for other applications.

### Unit Performance Data

Model Number	Size (tons)	Nominal Btu/hr	CFM (L/s)	Operating Dimensions H x W x D (sq) in (mm)	Filter Size in (mm)	Shipping Weight lbs (kg)
FCM4X2400AL	2	24,000	800 (378)	42-11/16 x 17-5/8 x 22-1/16 (1084 x 448 x 560)	16-3/8 x 21-1/2 (416 x 546)	135 (61)
FCM4X3600AL	3	36,000	1200 (566)	53-7/16 x 21-1/8 x 22-1/16 (1357 x 537 x 560)	19-7/8 x 21-1/2 (505 x 546)	150 (68)
FCM4X4800AL	4	48,000	1600 (755)	53-7/16 x 21-1/8 x 22-1/16 (1357 x 537 x 560)	19-7/8 x 21-1/2 (505 x 546)	172 (78)
FCM4X6000AL	5	60,000	1750 (826)	59-3/16 x 24-11/16 x 22-1/16 (1503 x 627 x 560)	23-5/16 x 21-1/2 (592 x 546)	207 (94)



# FVM4X

## Variable-Speed Fan Coils

2 – 5 Tons

### Features

- Supports two-stage outdoor units
- Available for Environmentally Sound R-410A systems
- Bolt-on, hard shut-off TXV metering device factory installed on all models
- Aluminum tube, aluminum fin evaporator coil
- Sweat connections
- Primary and secondary drain fittings with brass inserts
- Time delay relay (TDR)
- Field installed heater packages from 5 kW - 30 kW available separately
- HUD approved for manufactured housing
- 208/230-1-60 supply voltage
- Multi-position installation – upflow or horizontal left standard, horizontal right with minor modification (field convertible to downflow with accessory kits)
- Filter (washable) factory supplied
- Heat staging option
- Dehumidification function with standardized logic
- One-inch (25 mm) thick insulation with R value of 4.2

### Performance

- Variable-speed ECM motor on all models
- Adjustable cooling and heating on/off delay
- Heat Pump Comfort option to provide higher than normal heating air delivery temperature
- Units tested and certified by manufacturer to achieve a 2% or less leakage rate of 1-inch water column

### Easy-to-Install and Service

- Multiple electrical entry locations
- TXV and manifold positioned to the side for easier cleaning
- Zero clearance without heaters

### Warranty\*

- 10-year No Hassle Replacement™ limited warranty
- Five-year parts limited warranty – With timely registration, an additional five-year parts limited warranty

\* For residential applications only. See warranty certificate for complete details and restrictions, including warranty coverage for other applications.

### Unit Performance Data

Model Number	Size (tons)	Nominal Btu/hr	CFM (L/s) Range		Operating Dimensions H x W x D (sq) in (mm)	Filter Size in (mm)	Shipping Weight lbs (kg)
			Low	High			
FVM4X2400BL	2	24,000	350 (165)	1200 (566)	42-11/16 x 17-5/8 x 22-1/16 (1084 x 448 x 560)	16-3/8 x 21-1/2 (416 x 546)	135 (61)
FVM4X3600BL	3	36,000	415 (196)	1400 (661)	53-7/16 x 21-1/8 x 22-1/16 (1357 x 537 x 560)	19-7/8 x 21-1/2 (505 x 546)	150 (68)
FVM4X4800BL	4	48,000	425 (201)	1600 (755)	53-7/16 x 21-1/8 x 22-1/16 (1357 x 537 x 560)	19-7/8 x 21-1/2 (505 x 546)	172 (78)
FVM4X6000BL	5	60,000	540 (255)	2000 (944)	59-3/16 x 24-11/16 x 22-1/16 (1503 x 627 x 560)	23-5/16 x 21-1/2 (592 x 546)	207 (94)

# FXM4X

## Fan Coils

1-1/2 – 5 Tons  
Environmentally Sound R-410A Systems



### Features

- TXV metering device factory installed
- ECM five-speed motor
- Sweat connections
- Primary and secondary drain fittings with brass inserts
- Three amp automotive type fuse in wire harness
- Multiple electrical entry locations
- Time delay relay (TDR) programmed in motor
- Field installed heater packages from 5 kW – 30 kW available separately
- HUD approved for manufactured housing
- 208/230-1-60 supply voltage
- Units tested and certified by manufacturer to achieve a 2% or less leakage rate at 1-inch water column
- One-inch thick insulation with R value of 4.2
- Multi-position installation – upflow or horizontal left standard, horizontal right with minor modification (field convertible to downflow with available accessory kits)
- No Heat (Plug) Kit factory installed
- Filter (washable) factory supplied

### Warranty\*

- Five-year No Hassle Replacement™ limited warranty
- Five-year parts limited warranty
  - With timely registration, an additional five-year parts limited warranty

\* For residential applications only.  
See warranty certificate for complete details and restrictions, including warranty coverage for other applications.

### Unit Performance Data

Model Number	Size (tons)	Nominal Btu/hr	CFM (L/s)	Operating Dimensions H x W x D (sq) in (mm)	Filter Size in (mm)	Shipping Weight lbs (kg)
FXM4X1800A	1-1/2	18,000	600 (283)	49-5/8 x 17-5/8 x 22-1/16 (1261 x 448 x 560)	16-3/8 x 21-1/2 (416 x 546)	122 (55)
FXM4X1800AL	1-1/2	18,000	600 (283)	49-5/8 x 17-5/8 x 22-1/16 (1261 x 448 x 560)	16-3/8 x 21-1/2 (416 x 546)	122 (55)
FXM4X2400AL	2	24,000	800 (378)	49-5/8 x 17-5/8 x 22-1/16 (1261 x 448 x 560)	19-7/8 x 21-1/2 (505 x 546)	122 (55)
FXM4X3000AL	2-1/2	30,000	1000 (472)	53-7/16 x 21-1/8 x 22-1/16 (1357 x 537 x 560)	19-7/8 x 21-1/2 (505 x 546)	146 (66)
FXM4X3600AL	3	36,000	1200 (566)	49-5/8 x 21-1/8 x 22-1/16 (1261 x 537 x 560)	19-7/8 x 21-1/2 (505 x 546)	157 (71)
FXM4X4200AL	3-1/2	42,000	1400 (661)	49-5/8 x 21-1/8 x 22-1/16 (1261 x 537 x 560)	23-5/16 x 21-1/2 (592 x 546)	157 (71)
FXM4X4800AL	4	48,000	1600 (755)	53-7/16 x 24-11/16 x 22-1/16 (1357 x 627 x 560)	23-5/16 x 21-1/2 (592 x 546)	185 (84)
FXM4X6000AL	5	60,000	2000 (944)	59-3/16 x 24-11/16 x 22-1/16 (1503 x 627 x 560)	23-5/16 x 21-1/2 (592 x 546)	201 (91)

A = Coppertube, Aluminum Fin Evaporator Coil  
AL = Aluminum Tube, Aluminum Fin Evaporator Coil



# FEM4P

## Fan Coils

1-1/2 – 4 tons  
Environmentally Sound R-410A Systems

### Features

- Factory installed piston metering device with Teflon® ring
- ECM five-speed motor
- Sweat connections
- Aluminum tube, aluminum fin evaporator
- Primary and secondary drain fittings with brass inserts
- Low voltage circuit protective fuse (3 amp) inline on wire harness
- Multiple electrical entry locations
- Time delay relay (TDR)
- Field installed heater packages from 5 kW – 30 kW available separately
- HUD approved for manufactured housing
- 208/230-1-60 supply voltage
- Units tested and certified by manufacturer to achieve a 2% or less leakage rate at 1-inch water column
- One-inch thick insulation with R value of 4.2
- Multi-position installation – upflow or horizontal left standard, horizontal right with minor modification (field convertible to downflow with available accessory kits)
- No Heat (Plug) Kit factory installed
- Filter (washable) factory supplied

### Warranty\*

- One-year No Hassle Replacement™ limited warranty
- Five-year parts limited warranty
  - With timely registration, an additional five-year parts limited warranty

\* For residential applications only.  
See warranty certificate for complete details and restrictions, including warranty coverage for other applications.

### Unit Performance Data

Model Number	Size (tons)	CFM (L/s)	Operating Dimensions H x W x D (sq) in (mm)	Filter Size in (mm)	Shipping Weight lbs (kg)
FEM4P1800AL	1-1/2	600 (283)	42-11/16 x 14-5/16 x 22-1/16 (1084 x 364 x 560)	13 x 21-1/2 (330 x 546)	112 (51)
FEM4P2400AL	2	800 (378)	42-11/16 x 14-5/16 x 22-1/16 (1084 x 364 x 560)	13 x 21-1/2 (330 x 546)	112 (51)
FEM4P3000AL	2-1/2	1000 (472)	49-5/8 x 17-5/8 x 22-1/16 (1261 x 448 x 560)	16-3/8 x 21-1/2 (416 x 546)	122 (55)
FEM4P3600AL	3	1200 (566)	49-5/8 x 17-5/8 x 22-1/16 (1261 x 448 x 560)	16-3/8 x 21-1/2 (416 x 546)	122 (55)
FEM4P4200AL	3-1/2	1400 (661)	49-5/8 x 21-1/8 x 22-1/16 (1261 x 537 x 560)	19-7/8 x 21-1/2 (505 x 546)	157 (71)
FEM4P4800AL	4	1600 (755)	49-5/8 x 21-1/8 x 22-1/16 (1261 x 537 x 560)	19-7/8 x 21-1/2 (505 x 546)	157 (71)

# FEM4X

## Fan Coils

### 1-1/2 – 5 Tons Environmentally Sound R-410A Systems



#### Features

- Available for environmentally sound R-410A systems
- Factory installed TXV metering device
- Sweat connections
- Aluminum tube, aluminum fin evaporator
- Primary and secondary drain fittings with brass inserts
- Multiple electrical entry locations
- Time delay relay (TDR)
- Field installed heater packages from 5 kW – 30 kW available separately
- HUD approved for manufactured housing
- 208/230-1-60 supply voltage
- Units tested and certified by manufacturer to achieve a 2% or less leakage rate at 1-inch water column
- One-inch thick insulation with R value of 4.2
- ECM five-speed motor
- Multi-position installation – upflow or horizontal left standard, horizontal right with minor modification (field convertible to downflow with available accessory kit)
- Low voltage circuit protective fuse (3 amp) inline on wire harness
- No Heat (Plug) Kit factory installed
- Filter (washable) available as accessory

#### Warranty\*

- One-year No Hassle Replacement™ limited warranty
- Five-year parts limited warranty
  - With timely registration, an additional five-year parts limited warranty

\* For residential applications only.  
See warranty certificate for complete details and restrictions, including warranty coverage for other applications.

#### Unit Performance Data

Model Number	Size (tons)	Nominal CFM (L/s)	Operating Dimensions H x W x D (sq) in (mm)	Filter Size in (mm)	Shipping Weight lbs (kg)
FEM4X1800BL	1-1/2	600 (283)	42-11/16 x 14-5/16 x 22-1/16 (1084 x 364 x 560)	13 x 21-1/2 (330 x 546)	112 (51)
FEM4X2400CL	2	800 (378)	49-5/8 x 17-5/8 x 22-1/16 (1261 x 448 x 560)	16-3/8 x 21-1/2 (416 x 546)	122 (55)
FEM4X3000BL	2-1/2	1000 (472)	49-5/8 x 17-5/8 x 22-1/16 (1261 x 448 x 560)	16-3/8 x 21-1/2 (416 x 546)	122 (55)
FEM4X3600BL	3	1200 (566)	49-5/8 x 17-5/8 x 22-1/16 (1261 x 448 x 560)	16-3/8 x 21-1/2 (416 x 546)	122 (55)
FEM4X4200BL	3-1/2	1400 (661)	49-5/8 x 21-1/8 x 22-1/16 (1261 x 537 x 560)	19-7/8 x 21-1/2 (505 x 546)	157 (71)
FEM4X4800BL	4	1600 (755)	49-5/8 x 21-1/8 x 22-1/16 (1261 x 537 x 560)	19-7/8 x 21-1/2 (505 x 546)	157 (71)
FEM4X6000BL	5	1750 (826)	53-7/16 X 21-1/8 X 22-1/16 (1357 X 537 X 560)	19-7/8 x 21-1/2 (505 x 546)	175 (79)





# FMA4X, FMA4P

## Apartment Fan Coils

1-1/2 – 3 Tons

### All Models

- Upflow application only
- Accessory field installed electric heat kits available in 5, 7.5, or 10 kW
- 208/230-1-60 supply voltage
- Cabinet exterior is galvanized sheet metal
- Cabinet air leakage rate below 1.4% when tested to ASHRAE Standard 193
- Insulated for conditioned space (not to be installed in unconditioned spaces)
- All Aluminum coils

### Performance

- PSC motor on all FMA4P
- ECM motor on all FMA4X
- Motor suspended on rubber grommets for quieter operation
- Fresh air intake knockouts in cabinet

### Easy-to-Install and Service

- Units fit between standard stud spacings
- All service access is located in the front
- Primary and secondary drain connections exit from the bottom
- No return air ductwork required in specific applications
- Wall hanging brackets included with the unit

### FMA4P

- For use with R-410A refrigerant utilizing standard piston

### FMA4X

- R-410A refrigerant TXV standard

### Warranty\*

- Five-year parts limited warranty – With timely registration, an additional five-year parts limited warranty

\* For residential applications only. See warranty certificate for complete details and restrictions, including warranty coverage for other applications.

### Unit Performance Data

Model Number	Size (tons)	Nominal BTU	Nominal CFM (L/s)		Operating Dimensions H x W x D (sq) in (mm)	Filter Size in (mm)	Shipping Weight lbs (kg)
FMA4P1800AL	1-1/2	18,000	450 (212)	675 (319)	36-1/2 x 20-1/2 x 15 (928 x 521 x 381)	16 x 20 (406 x 508)	101 (46)
FMA4P2400AL	2	24,000	600 (283)	900 (425)	36-1/2 x 20-1/2 x 15 (928 x 521 x 381)	16 x 20 (406 x 508)	101 (46)
FMA4P3000AL	2-1/2	30,000	750 (354)	1125 (531)	39-1/2 x 22 x 19 (1004 x 559 x 483)	20 x 20 (508 x 508)	123 (56)
FMA4P3600AL	3	36,000	900 (425)	1350 (637)	39-1/2 x 22 x 19 (1004 x 559 x 483)	20 x 20 (508 x 508)	123 (56)

FMA4X1800AL	1-1/2	18,000	450 (212)	675 (319)	36-1/2 x 20-1/2 x 15 (928 x 521 x 381)	16 x 20 (406 x 508)	101 (46)
FMA4X2400AL	2	24,000	600 (283)	900 (425)	36-1/2 x 20-1/2 x 15 (928 x 521 x 381)	16 x 20 (406 x 508)	101 (46)
FMA4X3000AL	2-1/2	30,000	750 (354)	1125 (531)	39-1/2 x 22 x 19 (1004 x 559 x 483)	20 x 20 (508 x 508)	123 (56)
FMA4X3600AL	3	36,000	900 (425)	1350 (637)	39-1/2 x 22 x 19 (1004 x 559 x 483)	20 x 20 (508 x 508)	123 (56)

# FMU4X, FMU4Z, FMC4X, FMC4Z

## Horizontal Fan Coils

1-1/2 – 3 Tons

FMU4Z and FMC4Z 1-1/2, 2, 2-1/2, and 3 Tons

FMU4X and FMC4X 1-1/2, 2, 2-1/2 and 3 Tons

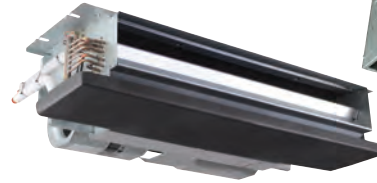

FMU4X & FMU4Z  
Uncased Horizontal Fan Coil



FMC4X & FMC4Z  
Cased Horizontal Fan Coil

### All Models

- Horizontal application only
- Accessory field installed electric heat kits available in 3, 5, 6, 7.5, or 10 kW
- 40 VA 208/230-1-60 supply voltage
- All Models use R-410A TXV metering device
- All Aluminum coils
- Adjustable condensate drainpan

### FMC4X and FMC4Z

- Horizontal return applications require field fabricated bottom cover or solid access panel accessory kit
- Cabinets meet the requirement of 1.4% cabinet leakage rate when tested to ASHRAE Standard 193
- Cabinets constructed to prevent cabinet sweating
- Refrigerant lines and electrical connections can be run out the back or side of casing

### Performance

- PSC motor on all FMU4X and FMC4X models
- ECM motor on all FMU4Z and FMC4Z models

### Easy-to-Install and Service

- A-coil design for maximum surface area
- Multiple electrical, refrigerant lineset and drain line entry for application flexibility
- Primary and secondary drain connections exit from the back or side of the cabinet
- Supports furred-down ceiling open return and ducted return applications
- Sweat connections for long term reliability
- Grooved aluminum tube / aluminum fin coils on all models

### Warranty\*

- Five-year parts limited warranty
  - With timely registration, an additional five-year parts limited warranty

\* For residential applications only.  
See warranty certificate for complete details and restrictions, including warranty coverage for other applications.

### Unit Performance Data

Model Number	Size (tons)	Nominal CFM (L/s)	Operating Dimensions H x W x D (sq) in (mm)	Shipping Weight lbs (kg)
<b>Uncased</b>				
FMU4Z1800AL	1-1/2	600 (283)	10-1/4 x 37-1/4 x 26-3/8 (260 x 946 x 670)	75 (34)
FMU4Z2400AL	2	800 (378)	10-1/4 x 37-1/4 x 26-3/8 (260 x 946 x 670)	75 (34)
FMU4Z3000AL	2-1/2	1000 (472)	10-1/4 x 49-1/4 x 26-3/8 (260 x 1251 x 670)	93 (42)
FMU4Z3600AL	3	1200 (566)	10-1/4 x 49-1/4 x 26-3/8 (260 x 1251 x 670)	93 (42)
FMU4X1800AL	1-1/2	600 (283)	10-1/4 x 37-1/4 x 26-3/8 (260 x 946 x 670)	75 (34)
FMU4X2400AL	2	800 (378)	10-1/4 x 37-1/4 x 26-3/8 (260 x 946 x 670)	75 (34)
FMU4X3000AL	2-1/2	1000 (472)	10-1/4 x 49-1/4 x 26-3/8 (260 x 1251 x 670)	93 (42)
FMU4X3600AL	3	1200 (566)	10-1/4 x 49-1/4 x 26-3/8 (260 x 1251 x 670)	93 (42)
<b>Cased</b>				
FMC4Z1800AL	1-1/2	600 (283)	11 x 39-3/4 x 27-3/4 (282 x 1010 x 704)	109 (49)
FMC4Z2400AL	2	800 (378)	11 x 39-3/4 x 27-3/4 (282 x 1010 x 704)	109 (49)
FMC4Z3000AL	2-1/2	1000 (472)	11 x 51-3/4 x 27-3/4 (282 x 1315 x 704)	135 (61)
FMC4Z3600AL	3	1200 (566)	11 x 51-3/4 x 27-3/4 (282 x 1315 x 704)	135 (61)
FMC4X1800AL	1-1/2	600 (283)	11 x 39-3/4 x 27-3/4 (282 x 1010 x 704)	109 (49)
FMC4X2400AL	2	800 (378)	11 x 39-3/4 x 27-3/4 (282 x 1010 x 704)	109 (49)
FMC4X3000AL	2-1/2	1000 (472)	11 x 51-3/4 x 27-3/4 (282 x 1315 x 704)	135 (61)
FMC4X3600AL	3	1200 (566)	11 x 51-3/4 x 27-3/4 (282 x 1315 x 704)	135 (61)

# Accessories

## Fan Coil (Piston)

Part Number	Description	Use With FEM4P
EBAC01DSC	Disconnect Kit	Use with All Single-Phase Heaters 5kW – 10kW
EBAC01NCB	Downflow Base Kit	1800, 2400
EBAC02NCB	Downflow Base Kit	3000, 3600
EBAC03NCB	Downflow Base Kit	4200, 4800
EBAC01DFS	Downflow Conversion Kit – Slope Coil	1800, 2400, 3000, 3600
EBAC02DFA	Downflow Conversion Kit – “A” Coil	4200, 4800
EBAC01SPK	Single Point Wiring Kit	Only for use with 15kW and 20kW Fused Heaters
EBAC01FKS	Filter Kit (washable, box of 12)	1800, 2400
EBAC01FKM	Filter Kit (washable, box of 12)	3000, 3600
EBAC01FKL	Filter Kit (washable, box of 12)	4200, 4800
EBAC01PLG	No Heat (Plug) Kit (box of six)	FEM4P – ALL (Factory Installed)
EBAC01GSK	Downflow Gasket Kit	ALL (required for horizontal right and downflow)
NAEA20101TX	TXV Kit, R-22, Copper and Tin Coils Only	1800, 2400, 3000, 3600, 4200
NAEA20201TX	TXV Kit, R-22, Copper and Tin Coils Only	4800
NAEA40501TX	TXV Kit, R-410A, Copper and Tin Coils Only	1800, 2400, 3000
NAEA40601TX	TXV Kit, R-410A, Copper and Tin Coils Only	3600, 4200
NAEA40701TX	TXV Kit, R-410A, Copper and Tin Coils Only	4800
NAEB40501TX	TXV Kit, R-410A, Aluminum Coils Only	1800AL, 2400AL, 3000AL
NAEB40601TX	TXV Kit, R-410A, Aluminum Coils Only	3600AL, 4200AL
NAEB40701TX	TXV Kit, R-410A, Aluminum Coils Only	4800AL
NAEB20101TX	TXV Kit, R-22, Aluminum Coils Only	1800AL, 2400AL, 3000AL, 3600AL, 4200AL
NAEB20201TX	TXV Kit, R-22, Aluminum Coils Only	4800AL
NASA00201FR	16" X 20" X 1" (406 X 508 X 250 mm)	3000, 3600
NASA00301FR	20" X 20" X 1" (508 X 508 X 250 mm)	4200, 4800
<b>Electric Heaters for FEM4P</b>		
EHK05AKN	5 kW, Single-Phase, No Internal Circuit Protection	ALL
EHK05AKB	5 kW, Single-Phase with Circuit Breakers	ALL
EHK07AKN	8 kW, Single-Phase, No Internal Circuit Protection	ALL
EHK07AKB	8 kW, Single-Phase with Circuit Breakers	ALL
EHK09AKCN	9 kW, Supplied as Single-Phase, Field Convertible to Three-Phase, No Internal Circuit Protection	3600, 4200, 4800
EHK10AKN	10 kW, Single-Phase, No Internal Circuit Protection	ALL
EHK10AKB	10 kW, Single-Phase with Circuit Breakers	ALL
EHK15AKF	15 kW, Single-Phase with Fuses	2400, 3000, 3600, 4200, 4800
EHK15AKB	15 kW, Single-Phase with Circuit Breakers	2400, 3000, 3600, 4200, 4800
EHK15AHN	15 kW, Three-Phase, No Internal Circuit Protection	3600, 4200, 4800

# Accessories

## Fan Coil (Piston)

Electric Heaters for FEM4P		
Part Number	Description	Use With
EHK18AHN	18kW, Three-Phase, No Internal Circuit Protection	4200, 4800
EHK20AKF	20 kW, Single-Phase with Fuses	3000, 3600, 4200, 4800
EHK20AKB	20 kW, Single-Phase with Circuit Breakers	3000, 3600, 4200, 4800
EHK25AHCF	24 kW, Supplied as Three-Phase, Field Convertible to Single-Phase with Fuses	4800
EHK30AHCF	30 kW, Supplied as Three-Phase, Field Convertible to Single-Phase with Fuses	4800
Accessories for use with FMA4P and FMA4X		
AMWK001WG	Louvered Wall Panel with Frame (6 Pack)	18, 24
AMWK002WG	Louvered Wall Panel with Frame (6 Pack)	30, 36
NAEA20101TX	TXV Kit, R-22	18, 24, 30, 36
NAEA40501TX	TXV Kit, R-410A	18, 24, 30
NAEA40601TX	TXV Kit, R-410A	36
NASA00110RA	Return Air Opening Grille (10 pack)	18, 24
NASA00210RA	Return Air Opening Grille (10 pack)	30, 36
Electric Heaters for FMA4P and FMA4X		
EHK205B	5 kW, Single-Phase	ALL
EHK208B	7.5 kW, Single-Phase	ALL
EHK210B	10 kW, Single-Phase	ALL
Accessories for use with FMU4P and FMC4P		
NASA00101GF	Louvered Wall Panel with Filter Rack – Small	18, 24
NASA00201GF	Louvered Wall Panel with Filter Rack – Large	30, 36
NASA00101CC	Access Panel – Small	18, 24
NASA00201CC	Access Panel – Large	30, 36
NAEA20101TX	TXV Kit, R-22	18, 24, 30, 36
NAEA40501TX	TXV Kit, R-410A	18, 24, 30
NAEA40601TX	TXV Kit, R-410A	36
Electric Heaters for use with FMU4P and FMC4P		
EHK305B	5 kW, Single-Phase	ALL
EHK308B	7.5 kW, Single-Phase	ALL
EHK310B	10 kW, Single-phase	ALL

# Accessories

## Fan Coil (TXV)

Part Number	Description	FCM4X	FVM4X	FXM4X	FEM4X
EBAC01DSC	Disconnect Kit	Use with all single-phase heaters 5 kW – 10kW			
EBAC01NCB	Downflow Base Kit	2400, 3600, 4800	–	–	1800B, 2400B
EBAC02NCB	Downflow Base Kit	–	2400	1800, 2400	2400C, 3000B, 3600B
EBAC03NCB	Downflow Base Kit	–	3600, 4800	3000, 3600, 4200	4200B, 4800B, 6000B
EBAC04NCB	Downflow Base Kit	6000B	6000B	4800, 6000	–
EBAC01DFS	Downflow Conversion Kit – Slope Coil	3600	3600	1800, 2400, 3000	1800B, 2400C, 3000B, 3600B
EBAC02DFA	Downflow Conversion Kit – A-Coil	2400, 4800, 6000	2400, 4800, 6000	3600, 4200, 4800, 6000	4200B, 4800B, 6000B
EBAC01SPK	Single Point Wiring Kit	Only for use with 15 kW and 20 kW fused heaters			
QOU14100JBAF	Single Point Wiring Kit – Square D® – Jumper Bar Assembly	Only for use with EHK15AKB and EHK20AKB breaker heaters			
EBAC01FKS	Filter Kit (Washable, Box of 12)	–	–	–	1800B
EBAC01FKM		2400*	2400*	1800*, 2400*	2400C, 3000B, 3600B
EBAC01FKL		3600*, 4800*	3600*, 4800*	3000*, 3600*, 4200*	4200B*, 4800B*, 6000B
EBAC01FKX		6000B	6000B	4800, 6000	–
NASA00101FR	12" X 20" x 1" (306 x 508 x 250 mm)	–	–	–	1800B
NASA00201FR	16" X 20" x 1" (406 x 508 x 250 mm)	2400	2400	1800, 2400	2400C, 3000B, 3600B
NASA00301FR	20" X 20" x 1" (508 x 508 x 250 mm)	3600, 4800	3600, 4800	3000, 3600, 4200	4200B, 4800B, 6000B
NASA00401FR	Standard Filter Rack (qty 2) (12" x 20" x 1" filter required)	6000B	6000B	4800, 6000	–
EBAC01PLG	No Heat (Plug) Kit (Box of 6)	ALL (factory installed)			
EBAC01GSK	Horizontal and Downflow Gasket Kit	ALL (required for horizontal right only)		ALL (required for horizontal right and downflow)	
NAEA20101TX	TXV Kit, R-22, Copper and Tin Coils Only	2400, 3600	2400, 3600	1800, 2400, 3000, 3600, 4200	1800, 2400, 3000, 3600, 4200
NAEA20201TX		4800	4800	4800	4800, 6000
NAEA20301TX		6000	6000	6000	–
NAEB20101TX	TXV Kit, R-22, Aluminum Coils Only	2400AL, 3600AL	2400AL, 3600AL	1800AL, 2400AL, 3000AL, 3600AL, 4200AL	1800BL, 2400CL, 3000BL, 3600BL, 4200BL
NAEB20201TX		4800AL	4800AL	4800AL	4800AL
NAEB20301TX		6000AL	6000AL	6000AL	6000BL

\*Factory Supplied

# Accessories

## Fan Coil (TXV)

<b>EHC Electric Heaters for FCM4X</b>		
<b>Part Number</b>	<b>Description</b>	<b>Use with</b>
EHC09AKCN	9 kW, Supplied as Single-Phase, No Internal Circuit Protection	ALL
EHC15AKF	15 kW, Single-Phase with Fuses	ALL
EHC15AKB	15 kW, Single-Phase with Circuit Breakers	ALL
EHC20AKF	20 kW, Single-Phase with Fuses	ALL
EHC20AKB	20 kW, Single-Phase with Circuit Breakers	ALL
EHC25AHCF	25 kW, Supplied as Three-Phase, Field Convertible to Single-Phase with Fuses	ALL
EHC30AHCF	30 kW, Supplied as Three-Phase, Field Convertible to Single-Phase with Circuit Breakers	4800, 6000
<b>EHK Electric Heaters for FCM4X</b>		
EHK05AKN	5 kW, Single-Phase, No Internal Circuit Protection	ALL
EHK05AKB	5 kW, Single-Phase with Circuit Breakers	ALL
EHK07AKN	8 kW, Single-Phase, No Internal Circuit Protection	ALL
EHK07AKB	8 kW, Single-Phase with Circuit Breakers	ALL
EHK09AKCN	9 kW, Supplied as Single-Phase, Field Convertible to Three-Phase, No Internal Circuit Protection	3600, 4800, 6000
EHK10AKN	10 kW, Single-Phase, No Internal Circuit Protection	ALL
EHK10AKB	10 kW, Single-Phase with Circuit Breakers	ALL
EHK15AKF	15 kW, Single-Phase with Fuses	ALL
EHK15AKB	15 kW, Single-Phase with Circuit Breakers	ALL
EHK15AHN	15 kW, Three-Phase, No Internal Circuit Protection	ALL
EHK18AHN	18 kW, Three-phase, No Internal Circuit Protection	4800, 6000
EHK20AKF	20 kW, Single-Phase with Fuses	ALL
EHK20AKB	20 kW, Single-Phase with Circuit Breakers	ALL
EHK25AHCF	24 kW, Supplied as Three-Phase, Field Convertible to Single-Phase with Fuses	4800, 6000
EHK30AHCF	30 kW, Supplied as Three-Phase, Field Convertible to Single-Phase with Fuses	4800, 6000
<b>EHK Electric Heaters for FVM, FXM4X, FEM, FSM</b>		
EHK05AKN	5 kW, Single-Phase, No Internal Circuit Protection	ALL
EHK05AKB	5 kW, Single-Phase with Circuit Breakers	ALL
EHK07AKN	8 kW, Single-Phase, No Internal Circuit Protection	ALL
EHK07AKB	8 kW, Single-Phase with Circuit Breakers	ALL
EHK09AKCN	9 kW, Supplied as Single-Phase, Field Convertible to Three-Phase, No Internal Circuit Protection	3600B, 4200B, 4800B, 6000B
EHK10AKN	10 kW, Single-Phase, No Internal Circuit Protection	ALL
EHK10AKB	10 kW, Single-Phase with Circuit Breakers	ALL
EHK14AKF	15 kW, Single-Phase with Fuses	2400C, 3000B, 3600B, 4200B, 4800B, 6000B
EHK15AKB	15 kW, Single-Phase with Circuit Breakers	2400C, 3000B, 3600B, 4200B, 4800B, 6000B
EHK15AHN	15 kW, Three-Phase, No Internal Circuit Protection	3600, 4200, 4800, 6000
EHK18AHN	18 kW, Three-Phase, No Internal Circuit Protection	4200, 4800, 6000
EHK20AKF	20 kW, Single-Phase with Fuses	3000, 3600, 4200, 4800, 6000
EHK20AKB	20 kW, Single-Phase with Circuit Breakers	3000, 3600, 4200, 4800, 6000

# Accessories

## Fan Coils

<b>EHK Electric Heaters for FVM, FXM4X, FEM</b>		
<b>Part Number</b>	<b>Description</b>	<b>Use with</b>
EHK25AHCF	24 kW, Supplied as Three-Phase, Field Convertible to Single-Phase with Fuses	4800B, 6000B
EHK30AHCF	30 kW, Supplied as Three-Phase, Field Convertible to Single-Phase with Fuses	4800B, 6000B
<b>MV and MF</b>		
AMF016DFB1	Downflow Kit	16
<b>Electric Heaters for MV and MF Series</b>		
EHIA00KN10	No Heat Kit	08, 12, 16, 20
EHIA05KB10	5 kW, Single-Phase with C.B.	08, 12, 16, 20
EHIA05KN10	5 kW, Single-Phase with T.B.	08, 12, 16, 20
EHIA07KB10	7.5 kW, Single-Phase with C.B.	08, 12, 16, 20
EHIA07KN10	7.5 kW, Single-Phase with T.B.	08, 12, 16, 20
EHIA10KB10	10 kW, Single-Phase with C.B.	08, 12, 16, 20
EHIA10KN10	10 kW, Single-Phase with T.B.	08, 12, 16, 20
EHIA15KB10	15 kW, Single-Phase with C.B.	08, 12, 16, 20
EHIA20KB10	20 kW, Single-Phase with C.B.	12, 16, 20
EHIA25KB10	25 kW, Single-Phase with C.B.	16, 20
EHIA10HB10	10 kW, Three-Phase with C.B.	12, 16, 20
EHIA15HB10	15 kW, Three-Phase with C.B.	12, 16, 20
EHIA20HB10	20 kW, Three-Phase with C.B.	16, 20
EHIA25HB10	25 kW, Three-Phase with C.B.	16, 20
<b>Accessories for FMU4X,4Z and FMC4X,4Z</b>		
EHK305B	5 kW, Single-Phase	ALL
EHK308B	7.5 kW, Single-Phase	ALL
EHK310B	10 kW, Single-Phase	ALL
NASA00101GF	Louvered Wall Panel with Filter Rack – Small	18, 24
NASA00201GF	Louvered Wall Panel with Filter Rack – Large	30, 36
NASA00101CC	Access Panel – Small	18, 24
NASA00201CC	Access Panel – Large	30, 36
NAEA20101TX	TXV Kit, R-22	18, 24, 30, 36
NAEA40501TX	TXV Kit, R410A	18, 24, 30
NAEA40601TX	TXV Kit, R410A	36

# EAM4X

## Multi-Position Evaporator Coils Cased A-Coils

1-1/2 – 5 Tons



### Features

- Bolt-on R-410A TXV metering device factory installed on all models (equalizer tube brazed in)
- TXV and manifold positioned to the side for easier cleaning
- Innovative drain pan design for complete water removal
- Two condensate drain connections (additional two for horizontal installation)
- Two-piece delta plate for easier removal and cleaning
- Cabinet widths match flush with ICP gas furnaces
- Hemmed flanges for safer handling
- Foil faced insulation
- Non-sweat cabinet, even at extreme conditions
- Cabinets meet or exceed 2% air leakage codes
- Sturdy, 22-gauge, pre-painted steel cabinet
- Multi-position installation - upflow, downflow, or horizontal
- One or two UV light knock-outs provided on cabinet (depending on size)
- Aluminum main tubing and aluminum fins (copper stubs for field connection)

### Warranty\*

- Five-year parts limited warranty
  - With timely registration, an additional five-year parts limited warranty

\* For residential applications only. See warranty certificate for complete details and restrictions, including warranty coverage for other applications.

### Unit Performance Data

Model Number	Size (tons)	Operating Dimensions H x W x D (sq) in (mm)
EAM4X18L14A	1-1/2	25-13/16 x 14-3/16 x 20-5/8 (659 x 361 x 524)
EAM4X19L17A	1-1/2	25-13/16 x 17-1/2 x 20-5/8 (659 x 445 x 524)
EAM4X24L14A	2	25-13/16 x 14-3/16 x 20-5/8 (659 x 361 x 524)
EAM4X24L17A	2	25-13/16 x 17-1/2 x 20-5/8 (659 x 445 x 524)
EAM4X25L17A	2	29-3/4 x 17-1/2 x 20-5/8 (757 x 445 x 524)
EAM4X30L14A	2-1/2	25-13/16 x 14-3/16 x 20-5/8 (659 x 361 x 524)
EAM4X30L17A	2-1/2	25-13/16 x 17-1/2 x 20-5/8 (659 x 445 x 524)
EAM4X30L14A	2-1/2	25-13/16 x 14-3/16 x 20-5/8 (659 x 361 x 524)
EAM4X36L14A	3	29-3/4 x 14-3/16 x 20-5/8 (757 x 360 x 524)
EAM4X36L17A	3	29-3/4 x 17-1/2 x 20-5/8 (757 x 445 x 524)
EAM4X36L21A	3	29-3/4 x 21 x 20-5/8 (757 x 533 x 524)
EAM4X37L17A	3	25-13/16 x 17-1/2 x 20-5/8 (656 x 445 x 524)
EAM4X37L21A	3	29-3/4 x 21 x 20-5/8 (757 x 533 x 524)
EAM4X42L21A	3-1/2	29-3/4 x 21 x 20-5/8 (757 x 533 x 524)
EAM4X42L24A	3-1/2	29-3/4 x 24-1/2 x 20-5/8 (757 x 622 x 524)
EAM4X43L21A	3-1/2	29-3/4 x 21 x 20-5/8 (757 x 533 x 524)
EAM4X48L17A	4	35 x 17-1/2 x 20-5/8 (889 x 445 x 524)
EAM4X48L21A	4	29-3/4 x 21 x 20-5/8 (757 x 533 x 524)
EAM4X48L24A	4	29-3/4 x 24-1/2 x 20-5/8 (757 x 622 x 524)
EAM4X60L21A	5	35 x 21 x 20-5/8 (889 x 533 x 524)
EAM4X60L24A	5	35 x 24-1/2 x 20-5/8 (889 x 622 x 524)
EAM4X61L21A	5	35 x 21 x 20-5/8 (889 x 533 x 524)
EAM4X61L24A	5	35 x 24-1/2 x 20-5/8 (889 x 622 x 524)





# EAD4X

## Upflow or Downflow Evaporator Coils Cased A-Coils

1-1/2 – 5 Tons

### Features

- Bolt-on R-410A TXV metering device factory installed on all models (equalizer tube brazed in)
- TXV and manifold positioned to the side for easier cleaning
- Innovative drain pan design for complete water removal
- Two condensate drain connections (additional two for horizontal installation)
- Two-piece delta plate for easier removal and cleaning
- Cabinet widths match flush with ICP gas furnaces
- Hemmed flanges for safer handling
- Foil faced insulation
- Non-sweat cabinet, even at extreme conditions
- Cabinets meet or exceed 2% air leakage codes
- Sturdy, 22-gauge, pre-painted steel cabinet
- Vertical installation – upflow or downflow
- One or two UV light knock-outs provided on cabinet (depending on size)
- Aluminum main tubing and aluminum fins (copper stubs for field connection)

### Warranty\*

- Five-year parts limited warranty
  - With timely registration, an additional five-year parts limited warranty

\* For residential applications only. See warranty certificate for complete details and restrictions, including warranty coverage for other applications.

### Unit Performance Data

Model Number	Size (tons)	Operating Dimensions H x W x D (sq) in (mm)
EAD4X19L17A	1-1/2	25-13/16 x 17-1/2 x 20-5/8 (659 x 445 x 524)
EAD4X25L17A	2	29-3/4 x 17-1/2 x 20-5/8 (757 x 445 x 524)
EAD4X37L17A	3	25-13/16 x 17-1/2 x 20-5/8 (659 x 445 x 524)
EAD4X37L21A	3	29-3/4 x 21 x 20-5/8 (757 x 533 x 524)
EAD4X43L21A	3-1/2	29-3/4 x 21 x 20-5/8 (757 x 533 x 524)
EAD4X61L24A	5	35 x 24-1/2 x 20-5/8 (889 x 622 x 524)

# EAA4X

## Upflow and Downflow Evaporator Coils Uncased A-Coils

1-1/2 – 5 Tons



### Features

- Bolt-on R-410A TXV metering device factory installed on all models (equalizer tube brazed in)
- TXV and manifold positioned to the side for easier cleaning
- Innovative drain pan design for complete water removal
- Two-piece delta plate for easier removal and cleaning
- Hemmed flanges for safer handling
- Vertical installation – upflow or downflow
- Aluminum main tubing and aluminum fins (copper stubs for field connection)

### Warranty\*

- Five-year parts limited warranty
  - With timely registration, an additional five-year parts limited warranty

\* For residential applications only.  
See warranty certificate for complete details and restrictions, including warranty coverage for other applications.

### Unit Performance Data

Model Number	Size (tons)	Operating Dimensions H x W x D (sq) in. (mm)
EAA4X18L14A	1-1/2	13-5/8 x 13 x 20-1/8 (346 x 330 x 511)
EAA4X24L14A	2	17-3/4 x 13 x 20-1/8 (451 x 330 x 511)
EAA4X24L17A	2	21-7/8 x 13 x 20-1/8 (556 x 330 x 511)
EAA4X30L14A	2-1/2	17-1/4 x 16-5/16 x 20-1/8 (451 x 414 x 511)
EAA4X30L17A	2-1/2	21-7/8 x 16-5/16 x 20-1/8 (545 x 414 x 511)
EAA4X36L17A	3	23-9/16 x 16-5/16 x 20-1/8 (598 x 414 x 511)
EAA4X36L21A	3	23 x 19-13/16 x 20-1/8 (584 x 503 x 511)
EAA4X42L21A	3-1/2	25-1/16 x 19-13/16 x 20-1/8 (637 x 503 x 511)
EAA4X48L21A	4	25-5/16 x 19-13/16 x 20-1/8 (643 x 503 x 511)
EAA4X48L24A	4	24-13/16 x 23-5/16 x 20-1/8 (630 x 592 x 511)
EAA4X60L24A	5	31-1/16 x 23-5/16 x 20-1/8 (789 x 592 x 511)



# END4X

## Vertical Evaporator Coils Cased N-Coils

1-1/2 – 5 Tons  
Environmentally Sound R-410A Systems

### Features

- Bolt-on TXV metering device factory installed on all models (equalizer tube brazed in)
- Two condensate drain connections
- Cabinet widths match flush with ICP 14-3/16", 17-1/2", 21" and 24-1/2" gas furnace cabinets (field fabricated transitions required to match other ICP furnace models)
- Removable front access panel
- Hemmed flanges for safer handling
- Foil faced insulation
- Non-sweat cabinet, even at extreme conditions
- Cabinets meet or exceed 2% air leakage codes
- Sturdy, pre-painted steel cabinet
- Upflow or downflow installation (cased use only)
- Compact design
- Aluminum main tubing and aluminum fins (copper stubs for field connection)

### Warranty\*

- Five-year parts limited warranty
  - With timely registration, an additional five-year parts limited warranty

\* For residential applications only.  
See warranty certificate for complete details and restrictions, including warranty coverage for other applications.

### Unit Performance Data

Model Number	Size (tons)	Operating Dimensions H x W x D (sq) in. (mm)
END4X18L14A	1-1/2	12-5/8 x 14-3/16 x 21 (321 x 360 x 533)
END4X19L17A	1-1/2	17 x 17-1/2 x 21 (432 x 445 x 533)
END4X24L14A	2	14-5/8 x 14-3/16 x 21 (372 x 360 x 533)
END4X24L17A	2	14-5/8 x 17-1/2 x 21 (372 x 445 x 533)
END4X30L14A	2-1/2	17 x 14-3/16 x 21 (432 x 360 x 533)
END4X30L17A	2-1/2	17 x 17-1/2 x 21 (432 x 445 x 533)
END4X31L17A	2-1/2	23-1/4 x 17-1/2 x 21 (591 x 445 x 533)
END4X36L17A	3	17 x 17-1/2 x 21 (432 x 445 x 533)
END4X36L21A	3	17 x 21 x 21 (432 x 533x 533)
END4X37L17A	3	27-3/16 x 17-1/2 x 21 (691 x 445 x 533)
END4X42L17A	3-1/2	21-1/8 x 17-1/2 x 21 (537 x 445 x 533)
END4X42L21A	3-1/2	19 x 21 x 21 (483 x 533 x 533)
END4X43L24A	3-1/2	26-5/16 x 24-1/2 x 21 (669 x 622 x 533)
END4X48L21A	4	22-1/16 x 21 x 21 (560 x 533 x 533)
END4X48L24A	4	22-1/16 x 24-1/2 x 21 (560 x 622 x 533)
END4X60L24A	5	26-7/8 x 24-1/2 x 21 (683 x 622 x 533)
END4X61L24A	5	32-7/16 x 24-1/2 x 21 (824 x 622 x 533)

# ENW4X

## Vertical Evaporator Coils Cased N-Coils

3 – 5 Tons  
Environmentally Sound R-410A Systems



### Features

- Drain pan raised 2" (51 mm) and block-off plate factory installed – for installing wider coil on narrower furnace
- Bolt-on TXV metering device factory installed on all models (equalizer tube brazed in)
- Two condensate drain connections
- Removable front access panel
- Hemmed flanges for safer handling
- Foil faced insulation
- Non-sweat cabinet, even at extreme conditions
- Cabinets meet or exceed 2% air leakage codes
- Sturdy, pre-painted steel cabinet
- Upflow or downflow installation (cased use only)
- Aluminum main tubing and aluminum fins (copper stubs for field connection)

### Warranty\*

- Five-year parts limited warranty
  - With timely registration, an additional five-year parts limited warranty

\* For residential applications only.  
See warranty certificate for complete details and restrictions, including warranty coverage for other applications.

### Unit Performance Data

Model Number	Size (tons)	Operating Dimensions H x W x D (sq) in. (mm)
ENW4X36L17A	3	19-13/16 x 17-1/2 x 21 (503 x 445 x 533)
ENW4X42L21A	3-1/2	21-13/16 x 21 x 21 (432 x 533 x 533)
ENW4X48L21A	4	24-7/8 x 21 x 21 (632 x 533 x 533)
ENW4X60L24A	5	29-1/8 x 24-1/2 x 21 (740 x 622 x 533)



# ENH4X

## Horizontal Evaporator Coils Cased N-Coils

2 – 5 Tons  
Environmentally Sound R-410A Systems

### Features

- Bolt-on TXV metering device factory installed on all models (equalizer tube brazed in)
- Two condensate drain connections
- Cabinet widths match flush with ICP 17-1/2", 21" and 24-1/2" gas furnace cabinets (field fabricated transitions required to match other ICP furnace models)
- Removable front access panel
- Hemmed flanges for safer handling
- Foil faced insulation
- Non-sweat cabinet, even at extreme conditions
- Cabinets meet or exceed 2% air leakage codes
- Sturdy, pre-painted steel cabinet
- Horizontal installation
- Aluminum main tubing and aluminum fins (copper stubs for field connection)

### Warranty\*

- Five-year parts limited warranty
  - With timely registration, an additional five-year parts limited warranty

\* For residential applications only. See warranty certificate for complete details and restrictions, including warranty coverage for other applications.

### Unit Performance Data

Model Number	Size (tons)	Operating Dimensions H x W x D (sq) in. (mm)
ENH4X24L17A	2	19 x 17-1/2 x 20-3/4 (483 x 445 x 527)
ENH4X30L17A	2-1/2	22-1/16 x 17-1/2 x 20-3/4 (560 x 445 x 527)
ENH4X31L17A	2-1/2	27-1/2 x 17-1/2 x 20-3/4 (699 x 445 x 527)
ENH4X36L17A	3	22-1/16 x 17-1/2 x 20-3/4 (560 x 445 x 527)
ENH4X42L21A	3-1/2	22-1/16 x 21 x 20-3/4 (560 x 533 x 527)
ENH4X43L21A	3-1/2	30-1/8 x 21 x 20-3/4 (766 x 533 x 527)
ENH4X48L21A	4	28-1/16 x 21 x 20-3/4 (713 x 533 x 527)
ENH4X60L24A	5	29 x 24-1/2 x 20-3/4 (737 x 622 x 527)
ENH4X61L24A	5	29-1/16 x 24-1/2 x 20-3/4 (737 x 622 x 527)

# EDM4X

## Cased Multi-Position A-Coils

1-1/2 – 5 Tons

Environmentally Sound R-410A Systems

Widths Match 15-1/2, 19-1/4, 22-3/4, 24-1/2 ICP Gas Furnaces



### Features

- Removable front access panel
- Easy slide-out coil for inspection
- Two UV light knock-outs provided on cabinet
- Hemmed flanges for safer handling
- Foil faced insulation
- Non-sweat cabinet, even at extreme conditions
- Cabinets meet or exceed 2% air leakage codes
- Multi-position installation – upflow, downflow or horizontal
- Sturdy, 22-gauge, pre-painted steel cabinet
- Aluminum main tubing and aluminum fins (copper stubs for field connection)

### Coil Features

- Bolt-on TXV metering device factory installed on all models (equalizer tube brazed in)
- TXV and manifold positioned to the side for easier cleaning
- Innovative drain pan design for complete water removal
- Two condensate drain connections
- Two-piece delta plate for easier removal and cleaning

### Warranty\*

- Five-year parts limited warranty
  - With timely registration, an additional five-year parts limited warranty

\* For residential applications only.

See warranty certificate for complete details and restrictions, including warranty coverage for other applications.

### Unit Performance Data

Model Number	Size (tons)	Operating Dimensions H x W x D (sq) in. (mm)
EDM4X18BAL	1-1/2	25-7/8 x 15-5/8 x 20-5/8 (657 x 397 x 524)
EDM4X24BAL	2	25-7/8 x 15-5/8 x 20-5/8 (657 x 397 x 524)
EDM4X24FAL	2	25-7/8 x 19-1/4 x 20-5/8 (657 x 489 x 524)
EDM4X30BAL	2-1/2	25-7/8 x 15-5/8 x 20-5/8 (657 x 397 x 524)
EDM4X30FAL	2-1/2	25-7/8 x 19-1/4 x 20-5/8 (657 x 489 x 524)
EDM4X36BAL	3	29-3/4 x 15-5/8 x 20-5/8 (756 x 397 x 524)
EDM4X36FAL	3	29-3/4 x 19-1/4 x 20-5/8 (756 x 489 x 524)
EDM4X36JAL	3	29-3/4 x 22-7/8 x 20-5/8 (756 x 581 x 524)
EDM4X42FAL	3-1/2	29-3/4 x 19-1/4 x 20-5/8 (756 x 489 x 524)
EDM4X42JAL	3-1/2	29-3/4 x 19-1/4 x 20-5/8 (756 x 489 x 524)
EDM4X42LAL	3-1/2	29-3/4 x 22-7/8 x 20-5/8 (756 x 581 x 524)
EDM4X48FAL	4	35 x 19-1/4 x 20-5/8 (889 x 489 x 524)
EDM4X48JAL	4	29-3/4 x 22-7/8 x 20-5/8 (756 x 581 x 524)
EDM4X48LAL	4	29-3/4 x 24-1/2 x 20-5/8 (756 x 622 x 524)
EDM4X60JAL	5	35 x 22-7/8 x 20-5/8 (889 x 581 x 524)
EDM4X61JAL	5	35 x 22-7/8 x 20-5/8 (881 x 581 x 524)
EDM4X60LAL	5	35 x 24-1/2 x 20-5/8 (881 x 622 x 524)



# ENA4X

## Vertical Evaporator Coils Uncased N-Coils

1-1/2 – 5 Tons  
Environmentally Sound R-410A Systems

### Features

- Bolt-on TXV metering device factory installed on all models (equalizer tube brazed in)
- Two condensate drain connections
- Upflow or downflow installation (plenum use only)
- Aluminum main tubing and aluminum fins (copper stubs for field connection)

### Warranty\*

- Five-year parts limited warranty
  - With timely registration, an additional five-year parts limited warranty

\* For residential applications only.  
See warranty certificate for complete details and restrictions, including warranty coverage for other applications.

### Unit Performance Data

Model Number	Size (tons)	Operating Dimensions H x W x D (sq) in. (mm)
ENA4X18L14A	1-1/2	10-7/8 x 12-7/8 x 19-3/8 (276 x 327 x 492)
ENA4X19L17A	1-1/2	14-11/16 x 16-1/4 x 19-3/8 (373 x 413 x 492)
ENA4X24L14A	2	12-7/8 x 12-7/8 x 19-3/8 (327 x 327 x 492)
ENA4X24L17A	2	12-11/16 x 16-1/4 x 19-3/8 (322 x 413 x 492)
ENA4X30L14A	2-1/2	14-7/8 x 12-7/8 x 19-3/8 (378 x 327 x 492)
ENA4X30L17A	2-1/2	14-11/16 x 16-1/4 x 19-3/8 (373 x 413 x 492)
ENA4X31L17A	2-1/2	20-3/4 x 16-1/4 x 19-3/8 (527 x 413 x 492)
ENA4X36L17A	3	14-11/16 x 16-1/4 x 19-3/8 (373 x 413 x 492)
ENA4X36L21A	3	14-7/16 x 19-5/8 x 19-3/8 (367 x 499 x 492)
ENA4X37L17A	3	24-3/4 x 16-1/4 x 19-3/8 (629 x 413 x 492)
ENA4X42L21A	3-1/2	16-1/2 x 19-5/8 x 19-3/8 (419 x 499 x 492)
ENA4X43L24A	3-1/2	24-3/8 x 23-1/8 x 19-3/8 (619 x 587 x 492)
ENA4X48L21A	4	20-9/16 x 19-5/8 x 19-3/8 (522 x 499 x 492)
ENA4X48L24A	4	20-5/16 x 23-1/8 x 19-3/8 (516 x 587 x 492)
ENA4X60L24A	5	24-3/8 x 23-1/8 x 19-3/8 (619 x 587 x 492)
ENA4X61L24A	5	30-1/2 x 23-1/8 x 19-3/8 (774 x 587 x 492)

# EMA4X

## Coils for Manufactured Housing

### 2, 3 and 4 Tons Environmentally Sound R-410A Systems

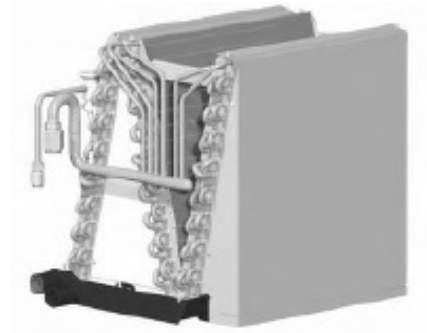

#### Features

- Designed for mobile home downflow gas furnaces
- Bolt-on TXV metering device factory installed on all models (equalizer tube brazed in)
- Two condensate drain connections
- “N” evaporator design to keep height at a minimum
- Shipped with condensate drain hose and trap
- Shipped with fittings and adapter plates
- Aluminum main tubing and aluminum fins (copper stubs for field connection)

#### Warranty\*

- Five-year parts limited warranty
  - With timely registration, an additional five-year parts limited warranty

\* For residential applications only.  
See warranty certificate for complete details and restrictions, including warranty coverage for other applications.

#### Unit Performance Data

Model Number	Size (tons)	Operating Dimensions H x W x D (sq) in. (mm)
EMA4X24DAL	2	12-5/8 x 17-7/8 x 19-9/16 (321 x 454 x 497)
EMA4X36DAL	3	14-11/16 x 17-7/8 x 19-9/16 (373 x 454 x 497)
EMA4X48DAL	4	18-3/4 x 17-7/8 x 19-9/16 (476 x 454 x 497)





# EHD4X

## Cased Horizontal Duct Coils

2 – 5 Tons  
Environmentally Sound R-410A Systems

### Features

- Horizontal, bi-directional airflow
- Bolt-on TXV metering device factory installed on all models (equalizer tube brazed in)
- Slide-out feature for easy cleaning
- Pre-painted steel cabinet
- Aluminum main tubing and aluminum fins (copper stubs for field connection)

### Warranty\*

- Five-year parts limited warranty
  - With timely registration, an additional five-year parts limited warranty

\* For residential applications only.  
See warranty certificate for complete details and restrictions, including warranty coverage for other applications.

### Unit Performance Data

Model Number	Size (tons)	Operating Dimensions H x W x D (sq) in. (mm)
EHD4X24AAL	2	28-3/8 x 11-3/4 x 24-1/16 (721 x 298 x 637)
EHD4X30AAL	2-1/2	28-3/8 x 11-3/4 x 24-1/16 (721 x 298 x 637)
EHD4X36AAL	3	28-3/8 x 11-3/4 x 28-13/16 (721 x 298 x 732)
EHD4X42AAL	3-1/2	28-3/8 x 11-3/4 x 28-13/16 (721 x 298 x 732)
EHD4X48AAL	4	30-3/8 x 11-3/4 x 28-13/16 (772 x 298 x 732)
EHD4X60AAL	5	30-3/8 x 11-3/4 x 38-15/16 (772 x 298 x 989)



# Ductless Systems



# DLCPRA

## Outdoor Unit Heat Pump Ductless System



Sizes 09-24

### Standard Features

- 100% heating capacity at 0°F (-17°C)
- 100% cooling capacity at -22°F (-30°C) without additional kit
- Up to 75% of heating capacity at -22°F (-30°C)
- Available in 208/230V
- Built-in basepan heater
- Auto-restart function
- Refrigerant leakage detection
- Quiet outdoor operation, as low as 55 dB(A)
- Aluminum Golden Hydrophilic pre-coated fins
- Piping length 98 ft. (30m)
- Cooling operating range -22° ~ 122°F (-30° ~ 50°C)
- Heating operating range -22° ~ 86°F (-25° ~ 30°C)

### Limited Warranty\*

- 10-year limited to original purchaser on compressor and parts upon timely registration, otherwise five years.

\* For residential applications. See warranty for full details.



### Unit Performance Data

Nominal System Btuh	Volt-Ph @ 60Hz	Unit Width in (mm)	Unit Height in (mm)	Unit Depth in (mm)	Net Weight lbs (kg)	Pipe Connection Size - Liquid in (mm)	Pipe Connection Size - Suction in (mm)	Model Number
9,000	208/230-1	33.27 (845)	27.64 (702)	14.29 (363)	107.59 (48.8)	1/4 (6.35)	3/8 (9.52)	DLCPRAH09AAK
12,000	208/230-1	33.27 (845)	27.64 (702)	14.29 (363)	108.47 (49.2)	1/4 (6.35)	1/2 (12.7)	DLCPRAH12AAK
18,000	208/230-1	37.24 (946)	31.89 (810)	16.14 (410)	135.4 (61.4)	3/8 (9.52)	5/8 (15.9)	DLCPRAH18AAK
24,000	208/230-1	37.24 (946)	31.89 (810)	16.14 (410)	145.1 (65.8)	3/8 (9.52)	5/8 (15.9)	DLCPRAH24AAK

See Product Data for Compatibility.

This document does not contain technical data controlled by the EAR or ITAR.

### Compatibility

Indoor Unit		Outdoor Unit			
		DLCPRAH09AAK	DLCPRAH12AAK	DLCPRAH18AAK	DLCPRAH24AAK
High Wall	DLFPHAH09XAK	•			
	DLFPHAH12XAK		•		
	DLFPHAH18XAK			•	
	DLFPHAH24XAK				•



# DLFPHA

## High Wall Heat Pump Ductless System

Sizes 09-24

### Standard Features

- Available in 208/230V
- Modes: Cool, Heat, Dry, Fan, Auto
- Turbo Mode
- Fully Modulating fan speeds
- Sleep Mode
- Up-Down / Right-Left Louver control (fixed or swing)
- Relative Humidity Sensor
- Built in occupancy sensor (Only sizes 09-12)
- ECO Mode
- Carbon Filter
- Follow Me (senses temperature at handheld remote)
- Heating Setback (46° F Heating Mode)
- Quiet indoor operation, as low as 29 dB(A)
- Aluminum Golden Hydrophilic pre-coated fins

### Controls:

- Wireless Remote Controller included with indoor unit
- Wired Remote Controller KSACN0401AAA (7 Day programmable) (Optional)
- Wi-Fi Kit (Optional)

### Limited Warranty\*

- 10-year limited to original purchaser on compressor and parts upon timely registration, otherwise five years.

\* For residential applications. See warranty for full details.



### Unit Performance Data

Nominal System Btuh	Volt-Ph @ 60Hz	Unit Width in (mm)	Unit Height in (mm)	Unit Depth in (mm)	Net Weight lbs (kg)	Pipe Connection Size - Liquid in (mm)	Pipe Connection Size - Suction in (mm)	Model Number
9,000	208/230-1	35.2 (895)	11.7 (298)	9.8 (248)	37.48 (17)	1/4 (6.35)	3/8 (9.52)	DLFPHAH09XAK
12,000	208/230-1	35.2 (895)	11.7 (298)	9.8 (248)	37.48 (17)	1/4 (6.35)	1/2 (12.7)	DLFPHAH12XAK
18,000	208/230-1	49.57 (1259)	14.25 (362)	11.10 (282)	43.4 (19.7)	3/8 (9.52)	5/8 (15.9)	DLFPHAH18XAK
24,000	208/230-1	49.57 (1259)	14.25 (362)	11.10 (282)	43.4 (19.7)	3/8 (9.52)	5/8 (15.9)	DLFPHAH24XAK

See Product Data for Compatibility.

This document does not contain technical data controlled by the EAR or ITAR.

### Compatibility

Indoor Unit	DLFPHAH09XAK	DLFPHAH12XAK	DLFPHAH18XAK	DLFPHAH24XAK
Outdoor Unit Single Zone*	DLCPRAH09AAK	DLCPRAH12AAK	DLCPRAH18AAK	DLCPRAH24AAK
Outdoor Unit Multi-Zone*	DLCMRAH18BAK			
	DLCMRAH27CAK			
	DLCMRAH36DAK			
	DLCMRAH48EAK			

\*Performance may vary based on the compatible outdoor units.

See respective pages for performance data.

# DLCSRA

## Outdoor Unit Heat Pump Ductless System



### Sizes 09-36

#### Standard Features

- 100% heating capacity at 5° F (-15° C) Sizes 12-18 (208/230V)
- Available in 115V and 208/230V
- Built-in basepan heater
- Auto-restart function
- Condenser high-temperature protection
- Refrigerant leakage detection
- Quiet outdoor operation, as low as 54.6 dB(A)
- Aluminum Golden Hydrophilic pre-coated fins
- Piping length 82 ~ 164 ft. (25 ~ 50 m)
- Cooling operating range -13° ~ 122° F (-25° ~ 50° C)
- Heating operating range -22° ~ 86° F (-30° ~ 30° C) – Sizes 9-24 (208/230V)  
-13° ~ 86° F (-25° ~ 30° C) – Sizes 12 (115V) & 30, 36 (208/230V)

#### Limited Warranty\*

- 10-year limited to original purchaser on compressor and parts upon timely registration, otherwise five years.

\* For residential applications. See warranty for full details.



Select Systems

#### Unit Performance Data

Nominal System Btuh	Volt-Ph @ 60Hz	Unit Width in (mm)	Unit Height in (mm)	Unit Depth in (mm)	Net Weight lbs (kg)	Pipe Connection Size - Liquid in (mm)	Pipe Connection Size - Suction in (mm)	Model Number
12,000	115-1	31.5 (800)	21.81 (554)	13.11 (333)	80.7 (36.6)	1/4 (6.35)	1/2 (12.7)	DLCSRAH12AAJ
9,000	208/230-1	31.5 (800)	21.81 (554)	13.11 (333)	90.8 (41.2)	1/4 (6.35)	3/8 (9.52)	DLCSRAH09AAK
12,000	208/230-1	31.5 (800)	21.81 (554)	13.11 (333)	91.7 (41.6)	1/4 (6.35)	1/2 (12.7)	DLCSRAH12AAK
18,000	208/230-1	33.27 (845)	27.63 (702)	14.26 (363)	113.3 (51.4)	1/4 (6.35)	1/2 (12.7)	DLCSRAH18AAK
24,000	208/230-1	37.24 (946)	31.89 (810)	16.54 (420)	141.1 (64)	3/8 (9.52)	5/8 (16)	DLCSRAH24AAK
30,000	208/230-1	37.24 (946)	31.89 (810)	16.54 (420)	137.8 (62.5)	3/8 (9.52)	5/8 (16)	DLCSRAH30AAK
36,000	208/230-1	37.24 (946)	31.89 (810)	16.54 (420)	143.3 (65)	3/8 (9.52)	5/8 (16)	DLCSRAH36AAK

See Product Data for Compatibility. This document does not contain technical data controlled by the EAR or ITAR.

#### Compatibility

Indoor Unit	DLCSRA Outdoor Unit						
	DLCSRAH12AAJ	DLCSRAH09AAK	DLCSRAH12AAK	DLCSRAH18AAK	DLCSRAH24AAK	DLCSRAH30AAK	DLCSRAH36AAK
DLFSHA High Wall	DLFSAH12XAJ	DLFSAH09XAK	DLFSAH12XAK	DLFSAH18XAK	DLFSAH24XAK	DLFSAH30XAK	DLFSAH36XAK
DLFSCA Cassette*		DLFSCAH09XAK	DLFSCAH12XAK	DLFSCAH18XAK	DLFSCAH24XAK		
DLFSDA Ducted*		DLFSDAH09XAK	DLFSDAH12XAK	DLFSDAH18XAK	DLFSDAH24XAK		
DLFSFA Console*			DLFSFAH12XAK	DLFSFAH18XAK	DLFSFAH24XAK		

\*Cassette, Ducted and Console indoor units sizes 36, 48 & 58 ONLY compatible with DLCLRA Outdoor Unit.



# DLFSHA

## High Wall Heat Pump Ductless System

Sizes 09-36

### Standard Features

- Available in 115V and 208/230V
- Modes: Cool, Heat, Dry, Fan, Auto
- Turbo Mode
- Four fan speeds
- Sleep Mode
- ECO Mode
- Up-Down Louver control (fixed or swing)
- Follow Me (senses temperature at handheld remote)
- Heating Setback (46° F Heating Mode)
- Quiet indoor operation, as low as 25 dB(A)
- Aluminum Golden Hydrophilic pre-coated fins

### Controls:

- Wireless Remote Controller included with indoor unit
- Wired Remote Controller KSACN0101AAA (Timer Function) (Optional)
- Wi-Fi Kit (Optional)

### Limited Warranty\*

- 10-year limited to original purchaser on compressor and parts upon timely registration, otherwise five years.

\* For residential applications. See warranty for full details.



Select Systems

### Unit Performance Data

Nominal System Btuh	Volt-Ph @ 60Hz	Unit Width in (mm)	Unit Height in (mm)	Unit Depth in (mm)	Net Weight lbs (kg)	Pipe Connection Size - Liquid in (mm)	Pipe Connection Size - Suction in (mm)	Model Number
12,000	115-1	31.89 (810)	11.81 (300)	7.87 (200)	18.7 (8.5)	1/4 (6.35)	1/2 (12.7)	DLFSHAH12XAJ
9,000	208/230-1	31.89 (810)	11.81 (300)	7.87 (200)	18.3 (8.3)	1/4 (6.35)	3/8 (9.52)	DLFSHAH09XAK
12,000	208/230-1	31.89 (810)	11.81 (300)	7.87 (200)	18.3 (8.3)	1/4 (6.35)	1/2 (12.7)	DLFSHAH12XAK
18,000	208/230-1	42.91 (1090)	13.31 (338)	9.25 (235)	29.8 (13.5)	1/4 (6.35)	1/2 (12.7)	DLFSHAH18XAK
24,000	208/230-1	42.91 (1090)	13.31 (338)	9.25 (235)	29.8 (13.5)	3/8 (9.52)	5/8 (16)	DLFSHAH24XAK
30,000	208/230-1	53.15 (1350)	14.37 (365)	10.71 (272)	46.3 (21)	3/8 (9.52)	5/8 (16)	DLFSHAH30XAK
36,000	208/230-1	53.15 (1350)	14.37 (365)	10.71 (272)	46.3 (21)	3/8 (9.52)	5/8 (16)	DLFSHAH36XAK

See Product Data for Compatibility. This document does not contain technical data controlled by the EAR or ITAR.

### Compatibility

Indoor Unit	DLFSHAH12XAJ	DLFSHAH09XAK	DLFSHAH12XAK	DLFSHAH18XAK	DLFSHAH24XAK	DLFSHAH30XAK	DLFSHAH36XAK
Outdoor Unit Single Zone*	DLCSRAH12AAJ	DLCSRAH09AAK	DLCSRAH12AAK	DLCSRAH18AAK	DLCSRAH24AAK	DLCSRAH30AAK	DLCSRAH36AAK
Outdoor Unit Multi-Zone*		DLCMRAH18BAK					
		DLCMRAH27CAK					
		DLCMRAH36DAK					
		DLCMRAH48EAK					

\*Performance may vary based on the compatible outdoor units. See respective pages for performance data.

# DLFSCA

## Cassette Heat Pump Ductless System



Sizes 09-18

Size 24

### Sizes 09-24

#### Standard Features

- Modes: Cool, Heat, Dry, Fan, Auto
- Auto-restart function
- Louver control (fixed or swing)
- Three fan speeds
- Outside Air Intake
- Built-in condensate lift pump
- Follow Me (senses temperature at handheld remote)
- Heating Setback (46° F Heating Mode)
- Quiet indoor operation
- Aluminum Golden Hydrophilic pre-coated fins
- Grille/ceiling panel 2" x 2" sizes 9 to 18 KSALG0101AAA
- Grille/ceiling panel 3" x 3" size 24 KSALG0201AAA

#### Controls:

- Wireless Remote Controller included with indoor unit
- Optional Wired Remote Controller KSACN0101AAA (Timer Function)
- Optional Wired Remote Controller KSACN0501AAA (7-Day programmable)
- Wi-Fi Kit (Optional)

#### Limited Warranty\*

- 10-year limited to original purchaser on compressor and parts upon timely registration, otherwise five years.

\* For residential applications. See warranty for full details.



#### Unit Performance Data

Nominal System Btuh	Volt-Ph @ 60Hz	Unit Width in (mm)	Unit Height in (mm)	Unit Depth in (mm)	Net Weight lbs (kg)	Pipe Connection Size - Liquid in (mm)	Pipe Connection Size - Suction in (mm)	Model Number
9,000	208/230-1	22.44 (570)	10.24 (260)	22.44 (570)	35.27 (16)	1/4 (6.35)	3/8 (9.52)	DLFSCAH09XAK
12,000	208/230-1	22.44 (570)	10.24 (260)	22.44 (570)	35.27 (16)	1/4 (6.35)	1/2 (12.7)	DLFSCAH12XAK
18,000	208/230-1	22.44 (570)	10.24 (260)	22.44 (570)	39.68 (18)	1/4 (6.35)	1/2 (12.7)	DLFSCAH18XAK
24,000	208/230-1	33.07 (840)	8.07 (205)	33.07 (840)	46.3 (21)	3/8 (9.52)	5/8 (16)	DLFSCAH24XAK

See Product Data for Compatibility.

This document does not contain technical data controlled by the EAR or ITAR.

#### Compatibility

Indoor Unit	DLFSCAH09XAK	DLFSCAH12XAK	DLFSCAH18XAK	DLFSCAH24XAK
Outdoor Unit Single Zone*	DLCSTRAH09AAK	DLCSTRAH12AAK	DLCSTRAH18AAK	DLCSTRAH24AAK
Outdoor Unit Multi-Zone*	DLCMRAH18BAK			
	DLCMRAH27CAK			
	DLCMRAH36DAK			
	DLCMRAH48EAK			

\*Performance may vary based on the compatible outdoor units. See respective pages for performance data.



# DLFSDA

## Ducted Heat Pump Ductless System



Sizes 09-24

### Standard Features

- Modes: Cool, Heat, Dry, Fan, Auto
- Vertical or horizontal installation
- Up to 0.64 in WG
- Rear or bottom return
- Outside Air Intake
- Built-in condensate lift pump
- Follow Me (senses temperature at handheld remote)
- Heating Setback (46° F Heating Mode)
- Quiet indoor operation, as low as 30 dB(A)
- Aluminum Golden Hydrophilic pre-coated fins

### Controls:

- Wireless Remote Controller included with indoor unit
- Optional Wired Remote Controller KSACN0101AAA (Timer Function)
- Wired Remote Controller KSACN0501AAA (7-Day programmable) included with indoor unit
- Wi-Fi Kit (Optional)

### Limited Warranty\*

- 10-year limited to original purchaser on compressor and parts upon timely registration, otherwise five years.

\* For residential applications. See warranty for full details.



Select Systems

### Unit Performance Data

Nominal System Btuh	Volt-Ph @ 60Hz	Unit Width in (mm)	Unit Height in (mm)	Unit Depth in (mm)	Net Weight lbs (kg)	Pipe Connection Size - Liquid in (mm)	Pipe Connection Size - Suction in (mm)	Model Number
9,000	208/230-1	27.56 (700)	7.87 (200)	19.92 (506)	43.56 (19.8)	1/4 (6.35)	3/8 (9.52)	DLFSDAH09XAK
12,000	208/230-1	27.56 (700)	7.87 (200)	19.92 (506)	43.56 (19.8)	1/4 (6.35)	1/2 (12.7)	DLFSDAH12XAK
18,000	208/230-1	34.65 (880)	8.27 (210)	26.54 (674)	54 (24.5)	1/4 (6.35)	1/2 (12.7)	DLFSDAH18XAK
24,000	208/230-1	43.31 (1100)	9.8 (249)	30.47 (774)	86.86 (39.4)	3/8 (9.52)	5/8 (16)	DLFSDAH24XAK

See Product Data for Compatibility.

This document does not contain technical data controlled by the EAR or ITAR.

### Compatibility

Indoor Unit	DLFSDAH09XAK	DLFSDAH12XAK	DLFSDAH18XAK	DLFSDAH24XAK
Outdoor Unit Single Zone*	DLCSRAH09AAK	DLCSRAH12AAK	DLCSRAH18AAK	DLCSRAH24AAK
Outdoor Unit Multi-Zone*	DLCMRAH18BAK			
	DLCMRAH27CAK			
	DLCMRAH36DAK			
	DLCMRAH48EAK			

\*Performance may vary based on the compatible outdoor units. See respective pages for performance data.

# DLFSFA

## Console Heat Pump Ductless System

Sizes 12-24



Console Size 12



Console 18-24



### Standard Features

- Modes: Cool, Heat, Dry, Fan, Auto
- Auto-restart function
- Size 12 capable to be mounted on Floor only
- Sizes 18-24 capable to be mounted on Floor and Ceiling
- Louver control (fixed or swing)
- Three fan speeds
- Air discharge from top and bottom (size 12)
- Follow Me (senses temperature at handheld remote)
- Heating Setback (46° F Heating Mode)
- Quiet indoor operation, as low as 34 dB(A)
- Aluminum Golden Hydrophilic pre-coated fins

### Controls:

- Wireless Remote Controller included with indoor unit
- Optional Wired Remote Controller KSACN0101AAA (Timer Function)
- Optional Wired Remote Controller KSACN0401AAA (7-Day programmable) Size 12
- Optional Wired Remote Controller KSACN0501AAA (7-Day programmable) Sizes 18 and 24
- Wi-Fi Kit (Optional Sizes 18 and 24)

### Limited Warranty\*

- 10-year limited to original purchaser on compressor and parts upon timely registration, otherwise five years.

\* For residential applications. See warranty for full details.



Select Systems

### Unit Performance Data

Nominal System Btuh	Volt-Ph @ 60Hz	Unit Width in (mm)	Unit Height in (mm)	Unit Depth in (mm)	Net Weight lbs (kg)	Pipe Connection Size - Liquid in (mm)	Pipe Connection Size - Suction in (mm)	Model Number
12,000	208/230-1	27.56 (700)	23.62 (600)	8.27 (210)	32.41 (14.7)	1/4 (6.35)	1/2 (12.7)	DLFSFAH12XAK
18,000	208/230-1	42.05 (1068)	26.57 (675)	9.25 (235)	55.12 (25)	1/4 (6.35)	1/2 (12.7)	DLFSFAH18XAK
24,000	208/230-1	42.05 (1068)	26.57 (675)	9.25 (235)	58.42 (26.5)	3/8 (9.52)	5/8 (16)	DLFSFAH24XAK

See Product Data for Compatibility.

This document does not contain technical data controlled by the EAR or ITAR.

### Compatibility

Indoor Unit	DLFSFAH12XAK	DLFSFAH18XAK	DLFSFAH24XAK
Outdoor Unit Single Zone*	DLCSRAH09AAK	DLCSRAH12AAK	DLCSRAH18AAK
Outdoor Unit Multi-Zone*	DLCMRAH18BAK		
	DLCMRAH27CAK		
	DLCMRAH36DAK		
	DLCMRAH48EAK		

\*Performance may vary based on the compatible outdoor units. See respective pages for performance data.



# DLCERA

## Outdoor Unit Cooling Only and Heat Pump Ductless System

Sizes 09-24

### STANDARD FEATURES

- Built-in basepan heater on Heat Pump units
- Cost competitive
- Available in 115V and 208/230V
- Auto-restart function
- Condenser high-temperature protection
- Refrigerant leakage detection
- Quiet outdoor operation, as low as 52 dB(A)
- Aluminum Golden Hydrophilic pre-coated fins
- Piping length 82 ~ 164 ft. (25 ~ 50 m)
- Cooling operating range 0° ~ 122° F (-17° ~ 50° C)
- Heating operating range 0° ~ 86° F (-17° ~ 30° C)

### Limited Warranty\*

- 10-year limited to original purchaser on compressor and parts upon timely registration, otherwise five years.

\* For residential applications. See warranty for full details.



### Unit Performance Data

Nominal System Btuh	Volt-Ph @ 60Hz	Unit Width in (mm)	Unit Height in (mm)	Unit Depth in (mm)	Net Weight lbs (kg)	Pipe Connection Size - Liquid in (mm)	Pipe Connection Size - Suction in (mm)	Model Number
12,000	115-1	30.31 (770)	21.85 (555)	11.81 (300)	57.8 (26.2)	1/4 (6.35)	1/2 (12.7)	DLCERAA12AAJ
12,000	208/230-1	30.31 (770)	21.85 (555)	11.81 (300)	53.8 (24.4)	1/4 (6.35)	1/2 (12.7)	DLCERAA12AAK
18,000	208/230-1	31.50 (800)	21.81 (554)	13.11 (333)	70.1 (31.8)	1/4 (6.35)	1/2 (12.7)	DLCERAA18AAK
24,000	208/230-1	33.27 (845)	27.64 (702)	14.29 (363)	88.6 (40.2)	3/8 (9.52)	5/8 (16)	DLCERAA24AAK

Nominal System Btuh	Volt-Ph @ 60Hz	Unit Width in (mm)	Unit Height in (mm)	Unit Depth in (mm)	Net Weight lbs (kg)	Pipe Connection Size - Liquid in (mm)	Pipe Connection Size - Suction in (mm)	Model Number
12,000	115-1	30.31 (770)	21.85 (555)	11.81 (300)	69 (31.3)	1/4 (6.35)	1/2 (12.7)	DLCERAH12AAJ
9,000	208/230-1	30.31 (770)	21.85 (555)	11.81 (300)	63 (28.6)	1/4 (6.35)	3/8 (9.52)	DLCERAH09AAK
12,000	208/230-1	30.31 (770)	21.85 (555)	11.81 (300)	65.5 (29.7)	1/4 (6.35)	1/2 (12.7)	DLCERAH12AAK
18,000	208/230-1	31.50 (800)	21.81 (554)	13.11 (333)	79.6 (36.1)	1/4 (6.35)	1/2 (12.7)	DLCERAH18AAK
24,000	208/230-1	33.27 (845)	27.64 (702)	14.29 (363)	114.2 (51.8)	3/8 (9.52)	5/8 (16)	DLCERAH24AAK

See Product Data for Compatibility. This document does not contain technical data controlled by the EAR or ITAR.

### Compatibility

Indoor Unit		Outdoor Unit			
		DLCERAA12AAJ	DLCERAA12AAK	DLCERAA18AAK	DLCERAA24AAK
DLFEHAA High Wall	DLFEHAA12XAJ	•			
	DLFEHAA12XAK		•		
	DLFEHAA18XAK			•	
	DLFEHAA24XAK				•

# DLFEHA

## High Wall Cooling Only and Heat Pump Ductless System

Sizes 09-24



### Standard Features

- Available in 115V and 208/230V
- Modes: Cool, Heat, Dry, Fan, Auto
- Turbo Mode
- Up-Down Louver control (fixed or swing)
- Remove filter from the top
- Improved serviceability
- Four fan speeds
- Sleep Mode
- Follow Me (senses temperature at handheld remote)
- Heating Setback (46° F Heating Mode)
- Quiet indoor operation, as low as 29 dB(A)
- Aluminum Golden Hydrophilic pre-coated fins

### Controls:

- Wireless Remote Controller included with indoor unit
- Optional Wired Remote Controller KSACN0401AAA (7-Day programmable)
- Wi-Fi Kit (Optional)



### Limited Warranty\*

- 10-year limited to original purchaser on compressor and parts upon timely registration, otherwise five years.

\* For residential applications. See warranty for full details.

### Unit Performance Data - Cooling Only

Nominal System Btuh	Volt-Ph @ 60Hz	Unit Width in (mm)	Unit Height in (mm)	Unit Depth in (mm)	Net Weight lbs (kg)	Pipe Connection Size - Liquid in (mm)	Pipe Connection Size - Suction in (mm)	Model Number
12,000	115-1	32.00 (813)	11.81 (300)	7.75 (197)	17.64 (8)	1/4 (6.35)	1/2 (12.7)	DLFEHAA12XAJ
12,000	208/230-1	32.00 (813)	11.81 (300)	7.75 (197)	17.64 (8)	1/4 (6.35)	1/2 (12.7)	DLFEHAA12XAK
18,000	208/230-1	38.36 (974)	12.8 (325)	8.87 (225)	23.15 (10.5)	1/4 (6.35)	1/2 (12.7)	DLFEHAA18XAK
24,000	208/230-1	43.83 (1113)	13.41 (341)	9.22 (234)	30.86 (14)	3/8 (9.52)	5/8 (16)	DLFEHAA24XAK

See Product Data for Compatibility.

This document does not contain technical data controlled by the EAR or ITAR.

### Compatibility

Cooling Only				
Indoor Unit	DLFEHAA12XAJ	DLFEHAA12XAK	DLFEHAA18XAK	DLFEHAA24XAK
Outdoor Unit Single Zone*	DLCERAA12AAJ	DLCERAA12AAK	DLCERAA18AAK	DLCERAA24AAK

## Unit Performance Data - Heat Pump

Nominal System Btuh	Volt-Ph @ 60Hz	Unit Width in (mm)	Unit Height in (mm)	Unit Depth in (mm)	Net Weight lbs (kg)	Pipe Connection Size - Liquid in (mm)	Pipe Connection Size - Suction in (mm)	Model Number
12,000	115-1	32.00 (813)	11.81 (300)	7.75 (197)	22.49 (10.2)	1/4 (6.35)	1/2 (12.7)	DLFEHAH12XAJ
9,000	208/230-1	28.53 (725)	11.81 (300)	7.75 (197)	21.16 (9.6)	1/4 (6.35)	3/8 (9.52)	DLFEHAH09XAK
12,000	208/230-1	32.00 (813)	11.81 (300)	7.75 (197)	22.49 (10.2)	1/4 (6.35)	1/2 (12.7)	DLFEHAH12XAK
18,000	208/230-1	38.36 (974)	12.8 (325)	8.87 (225)	31.97 (14.5)	1/4 (6.35)	1/2 (12.7)	DLFEHAH18XAK
24,000	208/230-1	43.83 (1113)	13.41 (341)	9.22 (234)	40.12 (18.2)	3/8 (9.52)	5/8 (16)	DLFEHAH24XAK

See Product Data for Compatibility.

This document does not contain technical data controlled by the EAR or ITAR.

Heat Pump				
Indoor Unit	DLFEHAH12XAJ	DLFEHAH09XAK	DLFSDAH18XAK	DLFSDAH24XAK
Outdoor Unit Single Zone*	DLCERAH12AAJ	DLCERAH09AAK	DLCSRAH18AAK	DLCSRAH24AAK
Outdoor Unit Multi-Zone*		DLCMRAH18BAK		
		DLCMRAH27CAK		
		DLCMRAH36DAK		
		DLCMRAH48EAK		

\*Performance may vary based on the compatible outdoor units. See respective pages for performance data.

# DLCMRA

## Outdoor Unit Multi-zone Heat Pump Ductless System

Sizes 18-48



18 (2)



27 (3) / 36 (4)



48 (5)

### Standard Features

Compatible with same Indoor Units as Single Zone

- Connect 2 ~ 5, multiple-style indoor units
- Basepan heater factory installed
- Quiet outdoor operation, as low 62 dB(A)
- Aluminum Golden Hydrophilic pre-coated fins
- Total piping length 131 ~ 328 ft. (40 ~ 100 m)
- Vertical Lift/Drop piping length 49 ~ 65 ft. (15 ~ 20 m)
- Cooling operating range -13° ~ 122°F (-25° ~ 50°C)
- Heating operating range -22° ~ 86°F (-30° ~ 30°C)



Select Systems

### Limited Warranty\*

- 10-year limited to original purchaser on compressor and parts upon timely registration, otherwise five years.







\* For residential applications. See warranty for full details.

### Unit Performance Data

Nominal System Btuh	Volt-Ph @ 60Hz	Unit Width in (mm)	Unit Height in (mm)	Unit Depth in (mm)	Net Weight lbs (kg)	Pipe Connection Size - Liquid in (mm)	Pipe Connection Size - Suction in (mm)	Model Number
18,000	208/230-1	37.31 (948)	27.64 (702)	14.82 (376)	105.8 (48)	1/4*2 (6.35*2)	3/8*2 (9.52*2)	DLCMRAH18BAK
24,000	208/230-1	41.22 (1047)	31.88 (810)	17.91 (455)	149.9 (68)	1/4*3 (6.35*3)	3/8*3 (9.52*3)	DLCMRAH27CAK
36,000	208/230-1	41.22 (1047)	31.88 (810)	17.91 (455)	156.5 (71)	1/4*4 (6.35*4)	1/2*1+3/8*3 (12.7*1+9.52*3)	DLCMRAH36DAK
48,000	208/230-1	41.15 (1045)	52.48 (1333)	17.63 (448)	223.8 (101.5)	1/4*5 (6.35*5)	1/2*2+3/8*3 (12.7*2+9.52*3)	DLCMRAH48EAK

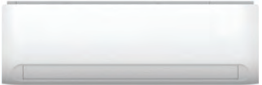
See Product Data for Compatibility. This document does not contain technical data controlled by the EAR or ITAR.

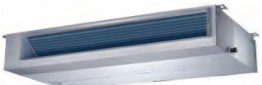
## Compatibility

Indoor Unit		Outdoor Unit				
		DLCMRAH18BAK	DLCMRAH27CAK	DLCMRAH36DAK	DLCMRAH48EAK	
<b>DLFPHA High Wall</b>	DLFPHAH09XAK	•	•	•	•	
	DLFPHAH12XAK	•	•	•	•	
<b>DLFSHA High Wall</b>	DLFSAH09XAK	•	•	•	•	
	DLFSAH12XAK	•	•	•	•	
	DLFSAH18XAK		•	•	•	
	DLFSAH24XAK			•	•	
<b>DLFEHA High Wall</b>	DLFEHAH09XAK	•	•	•	•	
	DLFEHAH12XAK	•	•	•	•	
	DLFEHAH18XAK		•	•	•	
	DLFEHAH24XAK			•	•	
<b>DLFSCA Cassette</b>	DLFSCAH09XAK	•	•	•	•	
	DLFSCAH12XAK	•	•	•	•	
	DLFSCAH18XAK		•	•	•	
	DLFSCAH24XAK			•	•	
<b>DLFSDA Ducted</b>	DLFSDAH09XAK	•	•	•	•	
	DLFSDAH12XAK	•	•	•	•	
	DLFSDAH18XAK		•	•	•	
	DLFSDAH24XAK			•	•	
<b>DLFSFA Console</b>	DLFSFAH12XAK	•	•	•	•	
	DLFSFAH18XAK		•	•	•	
	DLFSFAH24XAK			•	•	

# DLCLRA

## Outdoor Unit Heat Pump Ductless System

Sizes 36-58



36K



48K & 58K

### Standard Features

- Inverter Compressor
- Built-in basepan heater
- Condenser high-temperature protection
- Refrigerant leakage detection
- Quiet outdoor operation, as low as 62.5 dB(A)
- Aluminum Golden Hydrophilic pre-coated fins
- Piping length 213 ft. (65 m)
- Cooling operating range -13° ~ 122° F (-25° ~ 50° C)
- Heating operating range -22° ~ 86° F (-30° ~ 30° C)

### Limited Warranty\*

- 10-year limited to original purchaser on compressor and parts upon timely registration, otherwise five years.

\* For residential applications. See warranty for full details.



### Unit Performance Data

Nominal System Btuh	Volt-Ph @ 60Hz	Unit Width in (mm)	Unit Height in (mm)	Unit Depth in (mm)	Net Weight lbs (kg)	Pipe Connection Size - Liquid in (mm)	Pipe Connection Size - Suction in (mm)	Model Number
36,000	208/230-1	37.24 (946)	31.89 (810)	16.14 (410)	148.59 (67.4)	3/8 (9.52)	5/8 (16)	DLCLRAH36AAK
48,000	208/230-1	37.48 (952)	52.48 (1333)	16.34 (415)	217.4 (98.6)	3/8 (9.52)	5/8 (16)	DLCLRAH48AAK
58,000	208/230-1	37.48 (952)	52.48 (1333)	16.34 (415)	225.09 (102.1)	3/8 (9.52)	3/4 (19)	DLCLRAH58AAK

See Product Data for Compatibility.

This document does not contain technical data controlled by the EAR or ITAR.

### Compatibility

Indoor Unit		Outdoor Unit		
		DLCLRAH36AAK	DLCLRAH48AAK	DLCLRAH58AAK
DLFLCA Cassette	DLFLCAH36XAK	•		
	DLFLCAH48XAK		•	
DLFLCA Cassette	DLFLDAH36XAK	•		
	DLFLDAH48XAK		•	
	DLFLDAH58XAK			•
DLFLCA Cassette	DLFLFAH36XAK	•		
	DLFLFAH48XAK		•	
	DLFLFAH58XAK			•





### Standard Features

- Modes: Cool, Heat, Dry, Fan, Auto
- Auto-restart function
- Louver control (fixed or swing)
- Three fan speeds
- Outside Air Intake
- Built-in condensate lift pump
- Follow Me (senses temperature at handheld remote)
- Heating Setback (46° F Heating Mode)
- Quiet indoor operation, as low as 49 dB(A)
- Aluminum Golden Hydrophilic pre-coated fins
- Grille/ceiling panel 3" x 3" P/N KSALG0201AAA

### Controls:

- Wireless Remote Controller included with indoor unit
- Optional Wired Remote Controller KSACN0101AAA (Timer Function)
- Optional Wired Remote Controller KSACN0501AAA (7-Day programmable)
- Wi-Fi Kit (Optional)

### Limited Warranty\*

- 10-year limited to original purchaser on compressor and parts upon timely registration, otherwise five years.



\* For residential applications. See warranty for full details.

### Unit Performance Data

Nominal System Btuh	Volt-Ph @ 60Hz	Unit Width in (mm)	Unit Height in (mm)	Unit Depth in (mm)	Net Weight lbs (kg)	Pipe Connection Size - Liquid in (mm)	Pipe Connection Size - Suction in (mm)	Model Number
36,000	208/230-1	33.07 (840)	9.65 (245)	33.07 (840)	58.2 (26.4)	3/8 (9.52)	5/8 (16)	DLFLCAH36XAK
48,000	208/230-1	33.07 (840)	11.3 (287)	33.07 (840)	63.27 (28.7)	3/8 (9.52)	5/8 (16)	DLFLCAH48XAK

See Product Data for Compatibility.

This document does not contain technical data controlled by the EAR or ITAR.

### Compatibility

Indoor Unit	DLFLCAH36XAK	DLFLCAH48XAK
Outdoor Unit Single Zone*	DLCLRAH36AAK	DLCLRAH48AAK

\*Performance may vary based on the compatible outdoor units. See respective pages for performance data.

# DLFLDA

## Ducted Heat Pump Ductless System

Sizes 36-58

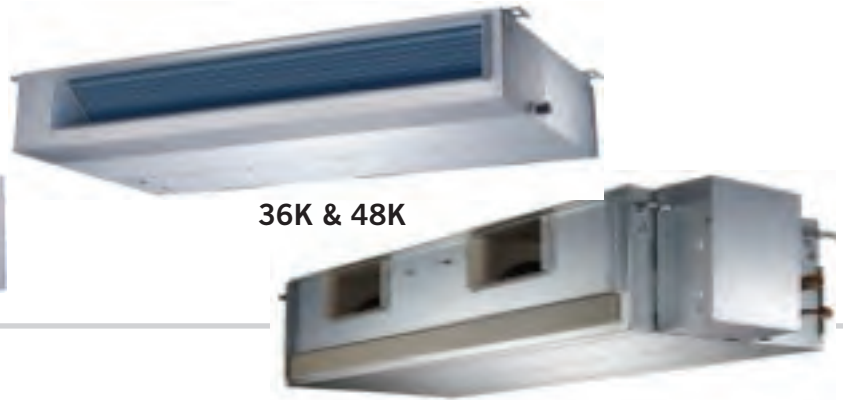

36K & 48K

58K

### Standard Features

- Modes: Cool, Heat, Dry, Fan, Auto
- Vertical (sizes 36 & 48) or Horizontal Installation
- Up to 0.8 in WG
- Rear or bottom return
- Outside Air Intake
- Built-in condensate lift pump
- Follow Me (senses temperature at handheld remote)
- Heating Setback (46° F Heating Mode)
- Quiet indoor operation, as low as 38.5 dB(A)
- Aluminum Golden Hydrophilic pre-coated fins

### Controls:

- Wireless Remote Controller included with indoor unit
- Wired Remote Controller (7-Day programmable) included with indoor unit
- Wi-Fi Kit (Optional)

### Limited Warranty\*

- 10-year limited to original purchaser on compressor and parts upon timely registration, otherwise five years.



\* For residential applications. See warranty for full details.

### Unit Performance Data

Nominal System Btuh	Volt-Ph @ 60Hz	Unit Width in (mm)	Unit Height in (mm)	Unit Depth in (mm)	Net Weight lbs (kg)	Pipe Connection Size - Liquid in (mm)	Pipe Connection Size - Suction in (mm)	Model Number
36,000	208/230-1	53.54 (1360)	9.8 (249)	30.47 (774)	106.48 (48.3)	3/8 (9.52)	5/8 (16)	DLFLDAH36XAK
48,000	208/230-1	47.24 (1200)	11.81 (300)	34.41 (874)	119.71 (54.3)	3/8 (9.52)	5/8 (16)	DLFLDAH48XAK
58,000	208/230-1	55.12 (1400)	17.32 (440)	33.78 (858)	163 (74)	3/8 (9.52)	3/4 (19)	DLFLDAH58XAK

See Product Data for Compatibility.

This document does not contain technical data controlled by the EAR or ITAR.

### Compatibility

Indoor Unit	DLFLDAH36XAK	DLFLDAH48XAK	DLFLDAH58XAK
Outdoor Unit Single Zone*	DLCLRAH36AAK	DLCLRAH48AAK	DLCLRAH58AAK

\*Performance may vary based on the compatible outdoor units.

See respective pages for performance data.



# DLFLFA

## Console Heat Pump Ductless System

Sizes 36-58

### Standard Features

- Modes: Cool, Heat, Dry, Fan, Auto
- Auto-restart function
- Capable to be mounted on Floor and Ceiling
- Louver control (fixed or swing)
- Three fan speeds
- Follow Me (senses temperature at handheld remote)
- Heating Setback (46° F Heating Mode)
- Quiet indoor operation, as low as 43 dB(A)
- Aluminum Golden Hydrophilic pre-coated fins

### Controls:

- Wireless Remote Controller included with indoor unit
- Optional Wired Remote Controller KSACN0101AAA (Timer Function)
- Optional Wired Remote Controller KSACN0501AAA (7-Day programmable)
- Wi-Fi Kit (Optional)

### Limited Warranty\*

- 10-year limited to original purchaser on compressor and parts upon timely registration, otherwise five years.

\* For residential applications. See warranty for full details.



### Unit Performance Data

Nominal System Btuh	Volt-Ph @ 60Hz	Unit Width in (mm)	Unit Height in (mm)	Unit Depth in (mm)	Net Weight lbs (kg)	Pipe Connection Size - Liquid in (mm)	Pipe Connection Size - Suction in (mm)	Model Number
36,000	208/230-1	50.59 (1285)	9.25 (235)	26.57 (675)	69 (31.3)	3/8 (9.52)	5/8 (16)	DLFLFAH36XAK
48,000	208/230-1	64.96 (1650)	9.25 (235)	26.57 (675)	83.78 (38)	3/8 (9.52)	5/8 (16)	DLFLFAH48XAK
58,000	208/230-1	64.96 (1650)	9.25 (235)	26.57 (675)	110 (50)	3/8 (9.52)	5/8 (16)	DLFLFAH58XAK

See Product Data for Compatibility.

This document does not contain technical data controlled by the EAR or ITAR.

### Compatibility

<b>Indoor Unit</b>	DLFLFAH36XAK	DLFLFAH48XAK	DLFLFAH58XAK
<b>Outdoor Unit Single Zone*</b>	DLCLRAH36AAK	DLCLRAH48AAK	DLCLRAH58AAK

\*Performance may vary based on the compatible outdoor units.

See respective pages for performance data.



# Small Packaged Products



*Low NOx units are designed for California installations and meet 40 ng/J NOx emissions. Can be installed in air quality management districts with a 40 ng/J NOx emissions requirement.*

# PGR5

Up to 16.0 SEER, Up to 12.5 EER Package Gas/Electric

2 – 5 Tons

208 / 230 Volt, Single-Phase, 60 Hz



## Refrigeration Circuit

- Environmentally balanced R-410A refrigerant
- Copper tube/aluminum fin condenser
- Tin-coated copper evaporator coil standard
- Two-stage scroll compressors standard on all models
- Two-stage gas valve and two-speed inducer motor on all models

## Built to Last

- Hail guard (3/8" spacing) wire grilles standard
- Induced-draft combustion and venting
- High-efficiency ECM indoor blower motor on all models
- Pre-painted steel cabinet
- Direct spark ignition
- Stainless steel tubular heat exchanger standard
- Vertical condenser fan discharge
- Full perimeter steel base rails
- Crankcase heaters on select models
- High- and low-pressure switches provide added reliability for the compressor
- Cabinet air leakage of 2.0% or less at .5 in. W.C. when tested in accordance with ASHRAE standard 193 - Models with this factory installed option are identified with letters 'GC' in the 11th and 12th positions in the model number.

## Easy-to-Install and Service

- Installs easily on a rooftop or at ground level
- Easy three-panel accessibility for maintenance and installation
- Easily converts to down discharge applications
- Combination gas heating and electric cooling
- Low NOx units available

## Warranty\*

- Five-year No Hassle Replacement™ limited warranty
- 10-year parts limited warranty (including compressor and coils) and lifetime heat exchanger limited warranty with timely registration
- Five-year parts limited warranty and 20-year heat exchanger limited warranty if not registered within 90 days of original installation

\* See warranty certificate for complete details and restrictions.

## Unit Performance Data

Model Number	Net Capacity BTU/h High/Low	SEER	EER	Input BTU/h	Efficiency AFUE %	Unit Dimensions H x W x D Inches (mm)	Operating Weight lbs (kg)
PGR524040KGC0B	23,000	15.0	12.0	40,000/26,000	81.00	44-1/8 x 48-3/16 x 32-5/8 (1121 x 1224 x 829)	344 (156)
PGR524040KGP*B	23,000	15.0	12.0	40,000/26,000	81.00	44-1/8 x 48-3/16 x 32-5/8 (1121 x 1224 x 829)	344 (156)
PGR524060KGC0B	23,000	15.0	12.0	60,000/39,000	81.00	44-1/8 x 48-3/16 x 32-5/8 (1121 x 1224 x 829)	344 (156)
PGR524060KGP*B	23,000	15.0	12.0	60,000/39,000	81.00	44-1/8 x 48-3/16 x 32-5/8 (1121 x 1224 x 829)	344 (156)
PGR530040KGC0B	29,000	15.0	12.0	40,000/26,000	81.0	44-3/4 x 48-3/16 x 44-1/8 (1137 x 1224 x 1122)	351 (159)
PGR530040KGP*B	29,000	15.0	12.0	40,000/26,000	81.0	44-3/4 x 48-3/16 x 44-1/8 (1137 x 1224 x 1122)	351 (159)
PGR530060KGC0B	29,000	15.0	12.0	60,000/39,000	81.0	44-3/4 x 48-3/16 x 44-1/8 (1137 x 1224 x 1122)	351 (159)
PGR530060KGP*B	29,000	15.0	12.0	60,000/39,000	81.0	44-3/4 x 48-3/16 x 44-1/8 (1137 x 1224 x 1122)	351 (159)
PGR536060KGC0B	35,400	16.0	12.5	60,000/39,000	81.0	44-3/4 x 48-3/16 x 44-1/8 (1137 x 1224 x 1122)	447 (203)
PGR536060KGP*B	35,400	16.0	12.5	60,000/39,000	81.0	44-3/4 x 48-3/16 x 44-1/8 (1137 x 1224 x 1122)	447 (203)

\*- 0 = Standard, 1 = Low NOx

GC = Low cabinet air leakage and Tin Plated Evaporator Main Tubes plus Stainless Steel Heat Exchanger

GP = Tin Coated Copper Evaporator Main Tubes plus Stainless Steel Heat Exchanger

### Unit Performance Data

Model Number	Cooling			Heating		Unit Dimensions H x W x D Inches (mm)	Operating Weight lbs (kg)
	Net Capacity BTU/h	SEER	EER	Input BTU/h	Efficiency AFUE %		
PGR536090KGC0B	35,400	16.0	12.5	90,000/58,500	81.0	44-3/4 x 48-3/16 x 44-1/8 (1137 x 1224 x 1122)	447 (203)
PGR536090KGP*B	35,400	16.0	12.5	90,000/58,500	81.0	44-3/4 x 48-3/16 x 44-1/8 (1137 x 1224 x 1122)	447 (203)
PGR542060KGC0B	42,000	16.0	12.5	60,000/39,000	81.0	44-3/4 x 48-3/16 x 44-1/8 (1137 x 1224 x 1122)	447 (203)
PGR542060KGP*B	42,000	16.0	12.3	60,000/39,000	81.0	44-3/4 x 48-3/16 x 44-1/8 (1137 x 1224 x 1122)	447 (203)
PGR542090KGC0B	42,000	16.0	12.3	90,000/58,500	81.0	44-3/4 x 48-3/16 x 44-1/8 (1137 x 1224 x 1122)	447 (203)
PGR542090KGP*B	42,000	16.0	12.3	90,000/58,500	81.0	44-3/4 x 48-3/16 x 44-1/8 (1137 x 1224 x 1122)	447 (203)
PGR548090KGC0B	47,500	16.0	12.3	90,000/58,500	81.0	50-3/4 x 48-3/16 x 44-1/8 (1289 x 1224 x 1122)	492 (223)
PGR548090KGP*B	47,500	16.0	12.3	90,000/58,500	81.0	50-3/4 x 48-3/16 x 44-1/8 (1289 x 1224 x 1122)	492 (223)
PGR548115KGC0B	47,500	16.0	12.3	115,000/75,000	81.0	50-3/4 x 48-3/16 x 44-1/8 (1289 x 1224 x 1122)	492 (223)
PGR548115KGP*B	47,500	16.0	12.3	115,000/75,000	81.0	50-3/4 x 48-3/16 x 44-1/8 (1289 x 1224 x 1122)	492 (223)
PGR548130KGC0B	47,500	16.0	12.3	127,000/84,500	81.0	50-3/4 x 48-3/16 x 44-1/8 (1289 x 1224 x 1122)	492 (223)
PGR548130KGP*B	47,500	16.0	12.3	127,000/84,500	81.0	50-3/4 x 48-3/16 x 44-1/8 (1289 x 1224 x 1122)	492 (223)
PGR560090KGC0B	57,000	16.0	12.3	90,000/58,500	81.0	52-3/4 x 48-3/16 x 44-1/8 (1340 x 1224 x 1122)	512 (232)
PGR560090KGP*B	57,000	16.0	12.3	90,000/58,500	81.0	52-3/4 x 48-3/16 x 44-1/8 (1340 x 1224 x 1122)	512 (232)
PGR560115KGC0B	57,000	16.0	12.3	115,000/75,000	81.0	52-3/4 x 48-3/16 x 44-1/8 (1340 x 1224 x 1122)	512 (232)
PGR560115KGP*B	57,000	16.0	12.3	115,000/75,000	81.0	52-3/4 x 48-3/16 x 44-1/8 (1340 x 1224 x 1122)	512 (232)
PGR560130KGC0B	57,000	16.0	12.3	127,000/84,500	81.0	52-3/4 x 48-3/16 x 44-1/8 (1340 x 1224 x 1122)	512 (232)
PGR560130KGP*B	57,000	16.0	12.3	127,000/84,500	81.0	52-3/4 x 48-3/16 x 44-1/8 (1340 x 1224 x 1122)	512 (232)

\* - 0 = Standard, 1 = Low NOx

GC = Low cabinet air leakage and Tin Plated Evaporator Main Tubes plus Stainless Steel Heat Exchanger

# PGS4

## Up to 14.5 SEER Package Gas/Electric

2 – 5 Tons

208 / 230 Volt, Single-Phase, 60 Hz



### Refrigeration Circuit

- Environmentally balanced R-410A refrigerant
- Tin-coated copper evaporator coil standard
- Dehumidification mode (airflow reduction) on all models

### Built to Last

- Stainless steel tubular heat exchanger
- Hail guard (3/8" spacing) wire grilles on all models
- Induced-draft combustion and venting
- Direct spark ignition
- High-efficiency ECM indoor blower motor on all models
- Vertical condenser fan discharge
- Full perimeter steel base rails
- High-pressure switch provides added reliability for the compressor
- Cabinet air leakage of 2.0% or less at .5 in. W.C. when tested in accordance with ASHRAE standard 193 - Models with this factory installed option are identified with letters 'GC' in the 11th and 12th positions in the model number.

### Easy-to-Install and Service

- Installs easily on a rooftop or at ground level
- Easy three-panel accessibility for maintenance and installation
- Easily converts to down discharge applications
- Combination gas heating and electric cooling
- Low NOx units available

### Warranty\*

- Three-year No Hassle Replacement™ limited warranty
- 10-year parts limited warranty (including compressor and coils) with timely registration
- Five-year parts limited warranty and 20-year heat exchanger limited warranty if not registered within 90 days of original installation

\* See warranty certificate for complete details and restrictions.

### Unit Performance Data

Model Number	Cooling			Heating		Unit Dimensions H x W x D Inches (mm)	Operating Weight lbs (kg)
	Net Capacity BTU/h	SEER	EER	Input BTU/h	Efficiency AFUE %		
PGS424040KGP*G	23,600	14.0	11.5	40,000	81.0	43-3/4 x 48-3/16 x 32-5/8 (1111 x 1224 x 829)	304 (138)
PGS424060KGP*G	23,600	14.0	11.5	60,000	81.0	43-3/4 x 48-3/16 x 32-5/8 (1111 x 1224 x 829)	304 (138)
PGS430040KGC*G	28,600	14.0	11.5	40,000	81.0	45-3/4 x 48-3/16 x 32-5/8 (1162 x 1224 x 829)	336 (152)
PGS430040KGP*G	28,600	14.0	11.5	40,000	81.0	45-3/4 x 48-3/16 x 32-5/8 (1162 x 1224 x 829)	336 (152)
PGS430060KGC*G	28,600	14.0	11.5	60,000	81.0	45-3/4 x 48-3/16 x 32-5/8 (1162 x 1224 x 829)	336 (152)
PGS430060KGP*G	28,600	14.0	11.5	60,000	81.0	45-3/4 x 48-3/16 x 32-5/8 (1162 x 1224 x 829)	336 (152)
PGS436060KGC*G	34,800	14.0	11.5	60,000	81.0	51-3/4 x 48-3/16 x 32-5/8 (1315 x 1224 x 829)	349 (158)
PGS436060KGP*G	34,800	14.0	11.5	60,000	81.0	51-3/4 x 48-3/16 x 32-5/8 (1315 x 1224 x 829)	349 (158)
PGS436090KGC*G	34,800	14.0	11.5	90,000	81.0	51-3/4 x 48-3/16 x 32-5/8 (1315 x 1224 x 829)	349 (158)
PGS436090KGP*G	34,800	14.0	11.5	90,000	81.0	51-3/4 x 48-3/16 x 32-5/8 (1315 x 1224 x 829)	349 (158)

\* 0 = Standard, 1 = Low NOx

GC = Low cabinet air leakage plus tin-coated copper evaporator main tubes (30-60 sizes).

GP = Tin Coated Copper Evaporator Main Tubes plus Stainless Steel Heat Exchanger



# PGS4 (con't)

Up to 14.5 SEER Package Gas/Electric

## Unit Performance Data

Model Number	Cooling			Heating		Unit Dimensions H x W x D Inches (mm)	Operating Weight lbs (kg)
	Net Capacity BTU/h	SEER	EER	Input BTU/h	Efficiency AFUE %		
PGS442060KGC*G	41,000	14.0	11.5	60,000	81.0	44-3/4 x 48-3/16 x 44-1/8 (1137 x 1224 x 1122)	413 (187)
PGS442060KGP*G	41,000	14.0	11.5	60,000	81.0	44-3/4 x 48-3/16 x 44-1/8 (1137 x 1224 x 1122)	413 (187)
PGS442090KGC*G	41,000	14.0	11.5	90,000	81.0	44-3/4 x 48-3/16 x 44-1/8 (1137 x 1224 x 1122)	413 (187)
PGS442090KGP*G	41,000	14.0	11.5	90,000	81.0	44-3/4 x 48-3/16 x 44-1/8 (1137 x 1224 x 1122)	413 (187)
PGS448090KGC*G	47,000	14.0	11.5	90,000	81.0	52-3/4 x 48-3/16 x 44-1/8 (1340 x 1224 x 1123)	438 (199)
PGS448090KGP*G	47,000	14.0	11.5	90,000	81.0	52-3/4 x 48-3/16 x 44-1/8 (1340 x 1224 x 1123)	438 (199)
PGS448115KGC*G	47,000	14.0	11.5	115,000	81.0	52-3/4 x 48-3/16 x 44-1/8 (1340 x 1224 x 1123)	438 (199)
PGS448115KGP*G	47,000	14.0	11.5	115,000	81.0	52-3/4 x 48-3/16 x 44-1/8 (1340 x 1224 x 1123)	438 (199)
PGS448130KGC*G	47,000	14.0	11.5	127,000	81.0	52-3/4 x 48-3/16 x 44-1/8 (1340 x 1224 x 1123)	438 (199)
PGS448130KGP*G	47,000	14.0	11.5	127,000	81.0	52-3/4 x 48-3/16 x 44-1/8 (1340 x 1224 x 1123)	438 (199)
PGS460090KGC*G	57,000	14.0	11.5	90,000	81.0	54-3/4 x 48-3/16 x 44-1/8 (1391 x 1224 x 1123)	455 (206)
PGS460090KGP*G	57,000	14.0	11.5	90,000	81.0	54-3/4 x 48-3/16 x 44-1/8 (1391 x 1224 x 1123)	455 (206)
PGS460115KGC*G	57,000	14.0	11.5	115,000	81.0	54-3/4 x 48-3/16 x 44-1/8 (1391 x 1224 x 1123)	455 (206)
PGS460115KGP*G	57,000	14.0	11.5	115,000	81.0	54-3/4 x 48-3/16 x 44-1/8 (1391 x 1224 x 1123)	455 (206)
PGS460130KGC*G	57,000	14.0	11.5	127,000	81.0	54-3/4 x 48-3/16 x 44-1/8 (1391 x 1224 x 1123)	455 (206)
PGS460130KGP*G	57,000	14.0	11.5	127,000	81.0	54-3/4 x 48-3/16 x 44-1/8 (1391 x 1224 x 1123)	455 (206)

\* 0 = Standard, 1 = Low NOx

GC = Low cabinet air leakage plus tin-coated copper evaporator main tubes (30-60 sizes).

# PGD4

## Up to 14.5 SEER Package Gas/Electric

2 – 5 Tons

208 / 230 Volt, Single-Phase, 60 Hz



### Refrigeration Circuit

- Environmentally balanced R-410A refrigerant
- Copper tube/aluminum fin condenser and evaporator coils
- Dehumidification mode (airflow reduction) on all models

### Built to Last

- Wire grilles with 2" spacing on all models
- Induced-draft combustion and venting
- Direct spark ignition
- High-efficiency ECM indoor blower motor on all models
- Aluminized steel tubular heat exchanger
- Vertical condenser fan discharge
- Full perimeter steel base rails
- High-pressure switch provides added reliability for the compressor
- Tin-coated copper evaporator main tubes (TP) as factory installed option
- Cabinet air leakage of 2.0% or less at .5 in. W.C. when tested in accordance with ASHRAE standard 193 - Models with this factory installed option are identified with letters 'LC' in the 11th and 12th positions in the model number.

### Easy-to-Install and Service

- Installs easily on a rooftop or at ground level
- Easy three-panel accessibility for maintenance and installation
- Easily converts to down discharge applications
- Combination gas heating and electric cooling
- Low NOx units available

### Warranty\*

- 15-year heat exchanger limited warranty
- 10-year parts limited warranty (including compressor and coils) with timely registration
- Five-year parts limited warranty and 15-year heat exchanger limited warranty if not registered within 90 days of original installation

\* See warranty certificate for complete details and restrictions.

### Unit Performance Data

Model Number	Cooling			Heating		Unit Dimensions H x W x D Inches (mm)	Operating Weight lbs (kg)
	Net Capacity BTU/h	SEER	EER	Input BTU/h	Efficiency AFUE %		
PGD424040K**^G	23,600	14.0	11.5	40,000	81.0	43-3/4 x 48-3/16 x 32-5/8 (1111 x 1224 x 829)	304 (138)
PGD424060K**^G	23,600	14.0	11.5	60,000	81.0	43-3/4 x 48-3/16 x 32-5/8 (1111 x 1224 x 829)	304 (138)
PGD430040K**^G	28,600	14.0	11.5	40,000	81.0	45-3/4 x 48-3/16 x 32-5/8 (1162 x 1224 x 829)	336 (152)
PGD430060K**^G	28,600	14.0	11.5	60,000	81.0	45-3/4 x 48-3/16 x 32-5/8 (1162 x 1224 x 829)	336 (152)
PGD436060K**^G	34,200	14.0	11.5	60,000	81.0	51-3/4 x 48-3/16 x 32-5/8 (1315 x 1224 x 829)	349 (158)
PGD436090K**^G	34,200	14.0	11.5	90,000	81.0	51-3/4 x 48-3/16 x 32-5/8 (1315 x 1224 x 829)	349 (158)
PGD442060K**^G	41,000	14.0	11.5	60,000	81.0	44-3/4 x 48-3/16 x 44-1/8 (1137 x 1224 x 1123)	413 (187)
PGD442090K**^G	41,000	14.0	11.5	90,000	81.0	44-3/4 x 48-3/16 x 44-1/8 (1137 x 1224 x 1123)	413 (187)
PGD448090K**^G	47,000	14.0	11.5	90,000	81.0	52-3/4 x 48-3/16 x 44-1/8 (1340 x 1224 x 1123)	438 (199)
PGD448115K**^G	47,000	14.0	11.5	115,000	81.0	52-3/4 x 48-3/16 x 44-1/8 (1340 x 1224 x 1123)	438 (199)

\*\* 00 = Standard - No Options

\*\* LC = Option code for Low cabinet air leakage plus Tin-Plated Copper Evaporator Main Tubes

\*\* TP = Option code for Tin-Plated Copper Evaporator Main Tubes

^ = 0 = Standard, 1 = Low NOx

### Unit Performance Data

Model Number	Cooling			Heating		Unit Dimensions H x W x D Inches (mm)	Operating Weight lbs (kg)
	Net Capacity BTU/h	SEER	EER	Input BTU/h	Efficiency AFUE %		
PGD448130K**^G	47,000	14.0	11.5	127,000	81.0	52-3/4 x 48-3/16 x 44-1/8 (1340 x 1224 x 1123)	438 (199)
PGD460090K**^G	57,000	14.0	11.5	90,000	81.0	54-3/4 x 48-3/16 x 44-1/8 (1391 x 1224 x 1123)	455 (206)
PGD460115K**^G	57,000	14.0	11.5	115,000	81.0	54-3/4 x 48-3/16 x 44-1/8 (1391 x 1224 x 1123)	455 (206)
PGD460130K**^G	57,000	14.0	11.5	127,000	81.0	54-3/4 x 48-3/16 x 44-1/8 (1391 x 1224 x 1123)	455 (206)

\*\* 00 = Standard - No Options

\*\* LC = Option code for Low cabinet air leakage plus Tin-Plated Copper Evaporator Main Tubes

\*\* TP = Option code for Tin-Plated Copper Evaporator Main Tubes

^ = 0 = Standard, 1 = Low NOx

# PDS4

## Up to 14.5 SEER Package Dual Fuel Heat Pump

2 – 5 Tons

208 / 230 Volt, Single-Phase, 60 Hz



### Refrigeration Circuit

- Environmentally balanced R-410A refrigerant
- Scroll compressor standard on all models
- Tin-coated copper evaporator main tubes standard
- Dehumidification mode (airflow reduction) on all models

### Built to Last

- Stainless steel tubular heat exchanger standard
- Factory installed option for low cabinet air leakage and tin-coated copper evaporator main tubes (GC), (Models with factory installed options are identified with letters in the 11th and 12th positions in the model number)
- Hail guard (3/8" spacing) wire grilles standard all models
- Pre-painted steel cabinet
- Induced-draft combustion and venting
- Direct spark ignition
- High-efficiency ECM indoor blower motor on all models
- Vertical condenser fan discharge
- Full perimeter steel base rails
- High- and low-pressure switches provide added reliability for the compressor

### Easy-to-Install and Service

- Installs easily on a rooftop or at ground level
- Easy three-panel accessibility for maintenance and installation
- Easily converts to down discharge applications
- Combination gas heating, heat pump heating and electric cooling
- Low NOx units available

### Warranty\*

- Three-year No Hassle Replacement™ limited warranty
- 10-year parts limited warranty (including compressor and coils) with timely registration and lifetime heat exchanger limited warranty with timely registration
- Five-year parts limited warranty and 20-year heat exchanger limited warranty if not registered within 90 days of original installation

\* See warranty certificate for complete details and restrictions.

### Unit Performance Data

Model Number	Cooling			Heating				Unit Dimensions H x W x D Inches (mm)	Operating Weight lbs (kg)
	Capacity BTU/h	SEER	EER	Capacity BTU/h	HSPF	Input BTU/h	Efficiency AFUE %		
PDS424040KGP*G	23,000	14.5	12.0	22,600	8.0	40,000	81.0	47-3/4 x 48-3/16 x 32-5/8 (1213 x 1224 x 829)	311 (141)
PDS424060KGP*G	23,000	14.5	12.0	22,600	8.0	60,000	81.0	47-3/4 x 48-3/16 x 32-5/8 (1213 x 1224 x 829)	311 (141)
PDS430040KGC*G	28,600	14.0	11.5	28,400	8.0	40,000	81.0	51-3/4 x 48-3/16 x 32-5/8 (1315 x 1224 x 829)	351 (159)
PDS430040KGP*G	28,600	14.0	11.5	28,400	8.0	40,000	81.0	51-3/4 x 48-3/16 x 32-5/8 (1315 x 1224 x 829)	351 (159)
PDS430060KGC*G	28,600	14.0	11.5	28,400	8.0	60,000	81.0	51-3/4 x 48-3/16 x 32-5/8 (1315 x 1224 x 829)	351 (159)
PDS430060KGP*G	28,600	14.0	11.5	28,400	8.0	60,000	81.0	51-3/4 x 48-3/16 x 32-5/8 (1315 x 1224 x 829)	351 (159)

\* 0 = Standard, 1 = Low NOx

GC = Low cabinet air leakage plus tin-coated copper evaporator main tubes (30-60 sizes).

GP = Tin Coated Copper Evaporator Main Tubes plus Stainless Steel Heat Exchanger

### Unit Performance Data

Model Number	Cooling			Heating				Unit Dimensions H x W x D Inches (mm)	Operating Weight lbs (kg)
	Capacity BTU/h	SEER	EER	Capacity BTU/h	HSPF	Input BTU/h	Efficiency AFUE %		
PDS436060KGC*G	34,200	14.0	11.5	34,400	8.0	60,000	81.0	48-3/4 x 48-3/16 x 44-1/8 (1238 x 1224 x 1122)	387 (176)
PDS436060KGP*G	34,200	14.0	11.5	34,400	8.0	60,000	81.0	48-3/4 x 48-3/16 x 44-1/8 (1238 x 1224 x 1122)	387 (176)
PDS436090KGC*G	34,200	14.0	11.5	34,400	8.0	90,000	81.0	48-3/4 x 48-3/16 x 44-1/8 (1238 x 1224 x 1122)	387 (176)
PDS436090KGP*G	34,200	14.0	11.5	34,400	8.0	90,000	81.0	48-3/4 x 48-3/16 x 44-1/8 (1238 x 1224 x 1122)	387 (176)
PDS442060KGC*G	41,000	14.0	11.5	40,000	8.0	60,000	81.0	54-3/4 x 48-3/16 x 44-1/8 (1391 x 1224 x 1122)	435 (197)
PDS442060KGP*G	41,000	14.0	11.5	40,000	8.0	60,000	81.0	54-3/4 x 48-3/16 x 44-1/8 (1391 x 1224 x 1122)	435 (197)
PDS442090KGC*G	41,000	14.0	11.5	40,000	8.0	90,000	81.0	54-3/4 x 48-3/16 x 44-1/8 (1391 x 1224 x 1122)	435 (197)
PDS442090KGP*G	41,000	14.0	11.5	40,000	8.0	90,000	81.0	54-3/4 x 48-3/16 x 44-1/8 (1391 x 1224 x 1122)	435 (197)
PDS448090KGC*G	48,000	14.0	12.0	46,000	8.0	90,000	81.0	54-3/4 x 48-3/16 x 44-1/8 (1391 x 1224 x 1122)	456 (207)
PDS448090KGP*G	48,000	14.0	12.0	46,000	8.0	90,000	81.0	54-3/4 x 48-3/16 x 44-1/8 (1391 x 1224 x 1122)	456 (207)
PDS448115KGC*G	48,000	14.0	12.0	46,000	8.0	115,000	81.0	54-3/4 x 48-3/16 x 44-1/8 (1391 x 1224 x 1122)	456 (207)
PDS448115KGP*G	48,000	14.0	12.0	46,000	8.0	115,000	81.0	54-3/4 x 48-3/16 x 44-1/8 (1391 x 1224 x 1122)	456 (207)
PDS448130KGC*G	48,000	14.0	12.0	46,000	8.0	130,000	81.0	54-3/4 x 48-3/16 x 44-1/8 (1391 x 1224 x 1122)	456 (207)
PDS448130KGP*G	48,000	14.0	12.0	46,000	8.0	130,000	81.0	54-3/4 x 48-3/16 x 44-1/8 (1391 x 1224 x 1122)	456 (207)
PDS460090KGC*G	57,500	14.0	11.5	57,500	8.0	90,000	81.0	48-3/4 x 48-3/16 x 44-1/8 (1238 x 1224 x 1122)	487 (221)
PDS460090KGP*G	57,500	14.0	11.5	57,500	8.0	90,000	81.0	48-3/4 x 48-3/16 x 44-1/8 (1238 x 1224 x 1122)	487 (221)
PDS460115KGC*G	57,500	14.0	11.5	57,500	8.0	115,000	81.0	48-3/4 x 48-3/16 x 44-1/8 (1238 x 1224 x 1122)	487 (221)
PDS460115KGP*G	57,500	14.0	11.5	57,500	8.0	115,000	81.0	48-3/4 x 48-3/16 x 44-1/8 (1238 x 1224 x 1122)	487 (221)
PDS460130KGC*G	57,500	14.0	11.5	57,500	8.0	130,000	81.0	48-3/4 x 48-3/16 x 44-1/8 (1238 x 1224 x 1122)	487 (221)
PDS460130KGP*G	57,500	14.0	11.5	57,500	8.0	130,000	81.0	48-3/4 x 48-3/16 x 44-1/8 (1238 x 1224 x 1122)	487 (221)

\* 0 = Standard, 1 = Low NOx

# PDD4

## Up to 14.5 SEER Package Dual Fuel Heat Pump

2 – 5 Tons

208 / 230 Volt, Single-Phase, 60 Hz



### Refrigeration Circuit

- Environmentally balanced R-410A refrigerant
- Scroll compressor standard on all models
- Copper tube/aluminum fin condenser and evaporator coils
- Dehumidification mode (airflow reduction) on all models

### Built to Last

- Wire grilles with 2" spacing on all models
- Pre-painted steel cabinet
- Induced-draft combustion and venting
- Direct spark ignition
- High-efficiency ECM indoor blower motor on all models
- Aluminized steel tubular heat exchanger
- Vertical condenser fan discharge
- Full perimeter steel base rails
- High- and low-pressure switches provide added reliability for the compressor

### Easy-to-Install and Service

- Installs easily on a rooftop or at ground level
- Easy three-panel accessibility for maintenance and installation
- Easily converts to down discharge applications
- Combination gas heating, heat pump heating and electric cooling
- Low NOx units available

### Warranty\*

- 15-year heat exchanger limited warranty
- 10-year parts limited warranty (including compressor and coils) with timely registration
- Five-year parts limited warranty if not registered within 90 days of original installation

\* See warranty certificate for complete details and restrictions.

### Unit Performance Data

Model Number	Cooling			Heating				Unit Dimensions H x W x D Inches (mm)	Operating Weight lbs (kg)
	Capacity BTU/h	SEER	EER	Capacity BTU/h	HSPF	Input BTU/h	Efficiency AFUE %		
PDD424040K00*G	23,000	14.5	12.0	22,600	8.0	40,000	81.0	47-3/4 x 48-3/16 x 32-5/8 (1213 x 1224 x 829)	311 (141)
PDD424060K00*G	23,000	14.5	12.0	22,600	8.0	60,000	81.0	47-3/4 x 48-3/16 x 32-5/8 (1213 x 1224 x 829)	311 (141)
PDD430040K00*G	28,600	14.0	14.0	28,400	8.0	40,000	81.0	51-3/4 x 48-3/16 x 32-5/8 (1315 x 1224 x 829)	351 (159)
PDD430060K00*G	28,600	14.0	14.0	28,400	8.0	60,000	81.0	51-3/4 x 48-3/16 x 32-5/8 (1315 x 1224 x 829)	351 (159)
PDD436060K00*G	34,200	14.0	11.5	34,400	8.0	60,000	81.0	48-3/4 x 48-3/16 x 44-1/8 (1238 x 1224 x 1122)	387 (176)
PDD436090K00*G	34,200	14.0	11.5	34,400	8.0	90,000	81.0	48-3/4 x 48-3/16 x 44-1/8 (1238 x 1224 x 1122)	387 (176)
PDD442060K00*G	41,000	14.0	11.5	40,000	8.0	60,000	81.0	54-3/4 x 48-3/16 x 44-1/8 (1391 x 1224 x 1122)	435 (197)
PDD442090K00*G	41,000	14.0	11.5	40,000	8.0	90,000	81.0	54-3/4 x 48-3/16 x 44-1/8 (1391 x 1224 x 1122)	435 (197)
PDD448090K00*G	48,000	14.0	12.0	46,000	8.0	90,000	81.0	54-3/4 x 48-3/16 x 44-1/8 (1391 x 1224 x 1122)	456 (207)
PDD448115K00*G	48,000	14.0	12.0	46,000	8.0	115,000	81.0	54-3/4 x 48-3/16 x 44-1/8 (1391 x 1224 x 1122)	456 (207)
PDD448130K00*G	48,000	14.0	12.0	46,000	8.0	130,000	81.0	54-3/4 x 48-3/16 x 44-1/8 (1391 x 1224 x 1122)	456 (207)
PDD460090K00*G	57,500	14.0	11.5	57,500	8.0	90,000	81.0	48-3/4 x 48-3/16 x 44-1/8 (1238 x 1224 x 1122)	487 (221)
PDD460115K00*G	57,500	14.0	11.5	57,500	8.0	115,000	81.0	48-3/4 x 48-3/16 x 44-1/8 (1238 x 1224 x 1122)	487 (221)
PDD460130K00*G	57,500	14.0	11.5	57,500	8.0	130,000	81.0	48-3/4 x 48-3/16 x 44-1/8 (1238 x 1224 x 1122)	487 (221)

\* 0 = Standard, 1 = Low NOx



# PAR5

## Up to 16.0 SEER, Up to 12.5 EER Package Air Conditioner

2 – 5 Tons  
208 / 230 Volt, Single-Phase, 60 Hz

### Refrigeration Circuit

- Environmentally balanced R-410A refrigerant
- Tin-coated copper evaporator coil standard
- Enhanced dehumidification feature on high-stage cooling with use of a dehumidistat
- Two-stage scroll compressors standard on all models

### Built to Last

- Hail guard (3/8" spacing) wire grilles standard
- Multi-speed ECM blower motor standard on all models
- Pre-painted steel cabinet
- Vertical condenser fan discharge
- Full perimeter steel base rails
- High- and low-pressure switches provide added reliability for the compressor
- Cabinet air leakage of 2.0% or less at .5 in. W.C. when tested in accordance with ASHRAE standard 193 - Models with this factory installed option are identified with letters 'GC' in the 11th and 12th positions in the model number.

### Easy-to-Install and Service

- Installs easily on a rooftop or at ground level
- Easy three-panel accessibility for maintenance and installation
- Easily converts to down discharge applications

### Warranty\*

- Five-year No Hassle Replacement™ limited warranty for models with tin-coated copper evaporator coil
- Five-year parts limited warranty (including compressor and coils)
  - With timely registration, an additional five-year parts limited warranty (including compressor and coils)

\* See warranty certificate for complete details.  
For residential applications only. See warranty certificate for complete details and restrictions, including warranty coverage for other applications.

### Unit Performance Data

Model Number	Net Capacity BTU/h High	Standard CFM High/Low	SEER	EER	Unit Dimensions H x W x D Inches (mm)	Operating Weight lbs (kg)
PAR524000KTP0A	23,000	800/600	15.0	12.0	44-1/8 x 48-3/16 x 31-3/16 (1121 x 1224 x 792)	327 (148)
PAR530000KTP0A	29,000	1000/750	15.0	12.0	46-1/8 x 48-3/16 x 31-3/16 (1172 x 1224 x 829)	334 (152)
PAR536000KTP0A	35,400	1200/900	16.0	12.5	44-3/4 x 48-1/4 x 42-15/16 (1137 x 1226 x 1091)	389 (176)
PAR542000KTP0A	42,000	1400/1050	16.0	12.5	50-3/4 x 48-1/4 x 42-15/16 (1289 x 1226 x 1091)	392 (178)
PAR548000KTP0A	47,500	1600/1200	16.0	12.3	48-3/4 x 48-1/4 x 42-15/16 (1238 x 1226 x 1091)	444 (201)
PAR560000KTP0A	57,000	1750/1200	16.0	12.3	54-3/4 x 48-1/4 x 42-15/16 (1391 x 1226 x 1091)	464 (211)

LC = Option code for Low cabinet air leakage plus Tin-Plated Copper Evaporator Main Tubes

TP = Option code for Tin-Plated Copper Evaporator Main Tubes

# PHR5

## Up to 15.5 SEER, Up to 12.5 EER, Up to 8.5 HSPF Package Heat Pump

2 – 5 Tons

208 / 230 Volt, Single-Phase, 60 Hz



### Refrigeration Circuit

- Environmentally balanced R-410A refrigerant
- Copper tube/aluminum fin condenser
- Tin-coated copper evaporator coil standard
- Enhanced dehumidification feature on high-stage cooling with use of a dehumidistat
- Two-stage scroll compressors standard on all models

### Easy-to-Install and Service

- Installs easily on a rooftop or at ground level
- Easy three-panel accessibility for maintenance and installation
- Easily converts to down discharge applications

### Warranty\*

- Five-year No Hassle Replacement™ limited warranty for models with tin-coated copper evaporator coil
- Five-year parts limited warranty (including compressor and coils)
  - With timely registration, an additional five-year parts limited warranty (including compressor and coils)

\* See warranty certificate for complete details.

For residential applications only. See warranty certificate for complete details and restrictions, including warranty coverage for other applications.

### Built to Last

- Hail guard (3/8" spacing) wire grilles standard
- Multi-speed ECM blower motor standard on all models
- Pre-painted steel cabinet
- Vertical condenser fan discharge
- Full perimeter steel base rails
- High- and low-pressure switches provide added reliability for the compressor
- Cabinet air leakage of 2.0% or less at .5 in. W.C. when tested in accordance with ASHRAE standard 193 (Low cabinet air leakage FIOP models only) Models with factory installed options are identified with letters in the 11th and 12th positions in the model number
- Factory installed option for low cabinet air leakage and tin-coated copper evaporator main tubes (LC)
- Factory installed tin-coated copper evaporator main tubes (TP)

### Unit Performance Data

Model Number	COOLING				HSPF	COP	Unit Dimensions H x W x D Inches (mm)	Weight lbs/kg
	BTU/h High	High/Low	SEER	EER				
PHR524000KADOB	22800	855/675	15.0	12.0	8.2	3.9	51-3/4 X 47 x 32-5/8 (1315 x 1194 x 829)	338/153
PHR524000KLCOB	22800	855/675	15.0	12.0	8.2	3.9	51-3/4 X 47 x 32-5/8 (1315 x 1194 x 829)	338/153
PHR524000KTPOB	22800	855/675	15.0	12.0	8.2	3.9	51-3/4 X 47 x 32-5/8 (1315 x 1194 x 829)	338/153
PHR530000KADOB	29400	1000/775	15.0	12.0	8.2	3.7	51-3/4 X 47 x 32-5/8 (1315 x 1194 x 829)	384/174
PHR530000KLCOB	29400	1000/775	15.0	12.0	8.2	3.7	51-3/4 X 47 x 32-5/8 (1315 x 1194 x 829)	384/174
PHR530000KTPOB	29400	1000/775	15.0	12.0	8.2	3.7	51-3/4 X 47 x 32-5/8 (1315 x 1194 x 829)	384/174
PHR536000KADOA	34000	1200/900	15.0	12.0	8.2	3.7	44-3/4 x 48-1/4 x 44-3/16 (1137 x 1226 x 1122)	413/187
PHR536000KLCOA	34000	1200/900	15.0	12.0	8.2	3.7	44-3/4 x 48-1/4 x 44-3/16 (1137 x 1226 x 1122)	413/187
PHR536000KTPOA	34000	1200/900	15.0	12.0	8.2	3.7	44-3/4 x 48-1/4 x 44-3/16 (1137 x 1226 x 1122)	413/187
PHR542000KADOA	42000	1400/1050	15.0	12.0	8.2	3.6	50-3/4 x 48-1/4 x 44-3/16 (1289 x 1226 x 1122)	444/201
PHR542000KLCOA	42000	1400/1050	15.0	12.0	8.2	3.6	50-3/4 x 48-1/4 x 44-3/16 (1289 x 1226 x 1122)	444/201
PHR542000KTPOA	42000	1400/1050	15.0	12.0	8.2	3.6	50-3/4 x 48-1/4 x 44-3/16 (1289 x 1226 x 1122)	444/201
PHR548000KADOA	47500	1600/1200	15.5	12.5	8.2	3.7	48-3/4 x 48-1/4 x 44-3/16 (1238 x 1226 x 1122)	447/203
PHR548000KLCOA	47500	1600/1200	15.5	12.5	8.2	3.7	48-3/4 x 48-1/4 x 44-3/16 (1238 x 1226 x 1122)	447/203
PHR548000KTPOA	47500	1600/1200	15.5	12.5	8.2	3.7	48-3/4 x 48-1/4 x 44-3/16 (1238 x 1226 x 1122)	447/203
PHR560000KADOA	57000	1750/1200	15.0	12.0	8.5	3.5	54-3/4 x 48-1/4 x 44-3/16 (1391 x 1226 x 1122)	503/228
PHR560000KLCOA	57000	1750/1200	15.0	12.0	8.5	3.5	54-3/4 x 48-1/4 x 44-3/16 (1391 x 1226 x 1122)	503/228
PHR560000KTPOA	57000	1750/1200	15.0	12.0	8.5	3.5	54-3/4 x 48-1/4 x 44-3/16 (1391 x 1226 x 1122)	503/228

AD = Advance Dehumidification Feature plus Tin Plated Evaporator Main Tubes

LC = Low cabinet air leakage plus Tin Coated Copper Evaporator Main Tubes

TP = Option code for Tin-Plated Copper Evaporator Main Tubes





# PAD4

## Up to 14.5 SEER, 12.0 EER Package Air Conditioner

2 – 5 Tons  
208 / 230 Volt, Single-Phase, 60 Hz

### Refrigeration Circuit

- Environmentally balanced R-410A refrigerant
- Copper tube/aluminum fin condenser and evaporator coils
- Dehumidification mode (airflow reduction) on all models

### Built to Last

- Factory installed option for low cabinet air leakage and tin-coated copper evaporator main tubes (LC)
- Available with optional factory installed tin-coated copper evaporator coil with 3/8" spacing wire grilles standard as hail guard (TP), all other models have 2" spacing wire grilles (Models with factory installed options are identified with letters in the 11th and 12th positions in the model number)
- High-efficiency ECM indoor blower motor on all models
- Vertical condenser fan discharge
- Full perimeter steel base rails
- High-pressure switch provides added reliability for the compressor

### Easy-to-Install and Service

- Installs easily on a rooftop or at ground level
- Easy three-panel accessibility for maintenance and installation
- Easily converts to down discharge applications

### Warranty\*

- Three-year No Hassle Replacement™ limited warranty for tin-coated 'TP' models
- 10-year parts limited warranty (including compressor and coils) with timely registration
- Five-year parts limited warranty if not registered within 90 days of original installation

\* See warranty certificate for complete details and restrictions.

### Unit Performance Data

Model Number	Net Capacity BTU/h High	SEER	EER	Unit Dimensions H x W x D Inches (mm)	Operating Weight lbs (kg)
PAD424000K000E	23,000	14.0	11.5	43-3/4 x 48-3/16 x 32-5/8 (1111 x 1224 x 829)	304 (138)
PAD424000KTPOE	23,000	14.0	11.5	43-3/4 x 48-3/16 x 32-5/8 (1111 x 1224 x 829)	304 (138)
PAD430000K000E	28,600	14.0	11.5	45-3/4 x 48-3/16 x 32-5/8 (1162 x 1224 x 829)	336 (152)
PAD430000KLCOE	28,600	14.0	11.5	45-3/4 x 48-3/16 x 32-5/8 (1162 x 1224 x 829)	336 (152)
PAD430000KTPOE	28,600	14.0	11.5	45-3/4 x 48-3/16 x 32-5/8 (1162 x 1224 x 829)	336 (152)
PAD436000K000E	34,800	14.0	11.5	51-3/4 x 48-3/16 x 32-5/8 (1315 x 1224 x 829)	349 (158)
PAD436000KLCOE	34,800	14.0	11.5	51-3/4 x 48-3/16 x 32-5/8 (1315 x 1224 x 829)	349 (158)
PAD436000KTPOE	34,800	14.0	11.5	51-3/4 x 48-3/16 x 32-5/8 (1315 x 1224 x 829)	349 (158)
PAD442000K000E	40,000	14.0	11.5	44-3/4 x 48-1/4 x 44-3/16 (1137 x 1226 x 1123)	413 (187)
PAD442000KLCOE	40,000	14.0	11.5	44-3/4 x 48-1/4 x 44-3/16 (1137 x 1226 x 1123)	413 (187)
PAD442000KTPOE	40,000	14.0	11.5	44-3/4 x 48-1/4 x 44-3/16 (1137 x 1226 x 1123)	413 (187)
PAD448000K000E	46,000	14.0	11.5	52-3/4 x 48-1/4 x 44-3/16 (1340 x 1226 x 1123)	438 (199)
PAD448000KLCOE	46,000	14.0	11.5	52-3/4 x 48-1/4 x 44-3/16 (1340 x 1226 x 1123)	438 (199)
PAD460000K000E	56,000	14.0	11.5	54-3/4 x 48-1/4 x 44-3/16 (1391 x 1226 x 1123)	455 (206)
PAD460000KLCOE	56,000	14.0	11.5	54-3/4 x 48-1/4 x 44-3/16 (1391 x 1226 x 1123)	455 (206)

\*\* LC = Option code for Low cabinet air leakage plus Tin-Plated Copper Evaporator Main Tubes

\*\* TP = Option code for Tin-Plated Copper Evaporator Main Tubes

# PHD4

## Up to 14.5 SEER, Up to 12.5 EER Package Air Conditioner

2 – 5 Tons

208 / 230 Volt, Single-Phase, 60 Hz



### Refrigeration Circuit

- Environmentally balanced R-410A refrigerant
- Copper tube/aluminum fin condenser and evaporator coils
- Scroll compressor standard on all models
- Short-cycling protection for the compressor is built into the defrost control board
- Dehumidification mode (airflow reduction) on all models

### Built to Last

- Factory installed optional for tin-coated copper evaporator coil with 3/8" spacing wire grilles standard as hail guard (TP)
- Factory installed option for low cabinet air leakage and factory installed tin-coated copper evaporator main tubes (LC) (Models with factory installed options are identified with letters in the 11th and 12th positions in the model number)
- Direct drive high-efficiency ECM indoor blower motor on all models
- Vertical condenser fan discharge
- Full perimeter steel base rails
- High- and low-pressure switches provide added reliability for the compressor

### Easy-to-Install and Service

- Installs easily on a rooftop or at ground level
- Easy three-panel accessibility for maintenance and installation
- Easily converts to down discharge applications
- Combination electric heating and cooling

### Warranty\*

- Three-year No Hassle Replacement™ limited warranty for tin-coated 'TP' models
- 10-year parts limited warranty (including compressor and coils) with timely registration

\* See warranty certificate for complete details and restrictions.

### Unit Performance Data

Model Number	Cooling			Heating		Unit Dimensions H x W x D Inches (mm)	Operating Weight lbs (kg)
	Capacity BTU/h	SEER	EER	Capacity BTU/h	HSPF		
PHD424000K000F	23,000	14.5	12.5	22,600	8.0	47-3/4 x 48-3/16 x 32-5/8 (1213 x 1224 x 829)	311 (141)
PHD424000KTPOF	23,000	14.5	12.5	22,600	8.0	47-3/4 x 48-3/16 x 32-5/8 (1213 x 1224 x 829)	311 (141)
PHD430000K000F	28,600	14.0	11.5	28,400	8.0	51-3/4 x 48-3/16 x 32-5/8 (1315 x 1224 x 829)	351 (159)
PHD430000KLCOF	28,600	14.0	11.5	28,400	8.0	51-3/4 x 48-3/16 x 32-5/8 (1315 x 1224 x 829)	351 (159)
PHD430000KTPOF	28,600	14.0	11.5	28,400	8.0	51-3/4 x 48-3/16 x 32-5/8 (1315 x 1224 x 829)	351 (159)
PHD436000K000F	34,200	14.0	11.5	34,400	8.0	48-3/4 x 48-3/16 x 44-3/16 (1137 x 1224 x 1122)	387 (176)
PHD436000KLCOF	34,200	14.0	11.5	34,400	8.0	48-3/4 x 48-3/16 x 44-3/16 (1137 x 1224 x 1122)	387 (176)
PHD436000KTPOF	34,200	14.0	11.5	34,400	8.0	48-3/4 x 48-3/16 x 44-3/16 (1137 x 1224 x 1122)	387 (176)
PHD442000K000F	41,000	14.0	11.5	40,000	8.0	54-3/4 x 48-3/16 x 44-3/16 (1238 x 1224 x 1122)	435 (197)
PHD442000KLCOF	41,000	14.0	11.5	40,000	8.0	54-3/4 x 48-3/16 x 44-3/16 (1238 x 1224 x 1122)	435 (197)
PHD442000KTPOF	41,000	14.0	11.5	40,000	8.0	54-3/4 x 48-3/16 x 44-3/16 (1238 x 1224 x 1122)	435 (197)
PHD448000K000F	48,000	14.0	12.0	46,000	8.0	54-3/4 x 48-3/16 x 44-3/16 (1238 x 1224 x 1122)	456 (207)
PHD448000KLCOF	48,000	14.0	12.0	46,000	8.0	54-3/4 x 48-3/16 x 44-3/16 (1238 x 1224 x 1122)	456 (207)
PHD448000KTPOF	48,000	14.0	12.0	46,000	8.0	54-3/4 x 48-3/16 x 44-3/16 (1238 x 1224 x 1122)	456 (207)
PHD460000K000F	57,500	14.0	11.5	57,500	8.0	48-3/4 x 48-3/16 x 44-3/16 (1391 x 1224 x 1122)	487 (221)
PHD460000KLCOF	57,500	14.0	11.5	57,500	8.0	48-3/4 x 48-3/16 x 44-3/16 (1391 x 1224 x 1122)	487 (221)
PHD460000KTPOF	57,500	14.0	11.5	57,500	8.0	48-3/4 x 48-3/16 x 44-3/16 (1391 x 1224 x 1122)	487 (221)

LC = Option code for Low cabinet air leakage plus Tin-Plated Copper Evaporator Main Tubes

TP = Option code for Tin-Plated Copper Evaporator Main Tubes



# PAJ4

## Up to 14.5 SEER, R-410A Package Air Conditioner for Manufactured Housing, Residential and Light Commercial Applications

2 – 5 Tons  
208 / 230 Volt, Single-Phase, 60 Hz

### Refrigeration Circuit

- Environmentally balanced R-410A refrigerant
- Liquid refrigerant filter driers
- Copper tube/aluminum fin condenser coils

### Built to Last

- Cabinet air leakage less than 2.0% at 1-inch water column and cabinet air leakage less than 1.4% at 0.5-inch water column when tested in accordance with ASHRAE Standard 193 (Models with factory installed options are identified with letters in the 11th and 12th positions in the model number)
- Vibration isolation provides quiet operation
- Compressors have internal over current protection
- Direct-drive multi-speed blower motor standard on all models
- No-rust base pan with integrated drain pan standard on all units
- Durable pre-painted steel cabinet
- Louvered coil enclosure for protection against vandalism and hail damage
- Aerodynamic fan blade design reduces the overall sound
- All models available with factory installed tin-coated copper evaporator coil (These models are identified with letters TP in the 11th and 12th positions in the model number)

### Easy-to-Install and Service

- Light weight, compact construction ideal for manufactured housing and residential applications
- Hand holds built into the unit base pan
- Compact, fully self-contained, electric cooling unit with horizontal supply and return ducts
- Easy panel accessibility for maintenance and installation
- Accessory electric heaters with single point connections
- Designed to be serviced from both the side and front

### Warranty\*

- 10-year parts limited warranty (including compressor and coils) with timely registration
- Five-year parts limited warranty if not registered within 90 days of original installation

\* See warranty certificate for complete details and restrictions.

### Unit Performance Data

Model Number	Nominal Tons	Capacity BTU/h	SEER	EER	Unit Dimensions H x W x D Inches (mm)	Operating Weight lbs (kg)
PAJ424000KTPOA	2.0	22,400	14.0	11.5	30-1/8 x 51 x 32 (765 x 1295 x 813)	230 (104)
PAJ430000KTPOA	2.5	28,600	14.0	11.5	30-1/8 x 51 x 32 (765 x 1295 x 813)	249 (113)
PAJ436000KTPOA	3.0	35,000	14.0	11.5	30-1/8 x 51 x 32 (765 x 1295 x 813)	272 (123)
PAJ442000KTPOA	3.5	41,000	14.5	11.5	34-1/8 x 51 x 32 (867 x 1295 x 813)	275 (125)
PAJ448000KTPOA	4.0	47,000	14.0	11.5	42-1/8 x 51 x 32 (1070 x 1295 x 813)	318 (144)
PAJ460000KTPOA	5.0	54,000	14.0	11.3	42-1/8 x 51 x 32 (1070 x 1295 x 813)	344 (156)

# PHJ4

## Up to 14.5 SEER, R-410A Package Heat Pump for Manufactured Housing, Residential and Light Commercial Applications

2 – 5 Tons  
208 / 230 Volt, Single-Phase, 60 Hz



2 – 5 Tons  
208 / 230 Volt, Single-Phase, 60 Hz

### Refrigeration Circuit

- Environmentally balanced R-410A refrigerant
- Liquid refrigerant filter driers
- Copper tube/aluminum fin condenser coils

### Built to Last

- Vibration isolation provides quiet operation
- Compressors have internal over current protection
- Direct-drive multi-speed blower motor standard on all models
- No-rust base pan with integrated drain pan standard on all units
- Durable pre-painted steel cabinet
- Louvered coil enclosure for protection against vandalism and hail damage
- Aerodynamic fan blade design reduces the overall sound
- All models available with factory installed tin-coated copper evaporator coil (These models are identified with letters TP in the 11th and 12th positions in the model number)

### Warranty\*

- 10-year parts limited warranty (including compressor and coils) with timely registration
- Five-year parts limited warranty if not registered within 90 days of original installation

\* See warranty certificate for complete details and restrictions.

### Easy-to-Install and Service

- Light weight, compact construction ideal for manufactured housing and residential applications
- Hand holds built into the unit base pan
- Compact, fully self-contained, electric cooling and heating unit with horizontal supply and return ducts
- Easy panel accessibility for maintenance and installation
- Accessory electric heaters with single point connections
- Designed to be serviced from both the side and front
- Cabinet air leakage less than 2.0% at 1-inch water column and cabinet air leakage less than 1.4% at 0.5-inch water column when tested in accordance with ASHRAE Standard 193
- All models available with optional factory installed tin-coated copper evaporator coil (Models with factory installed options are identified with letters TP in the 11th and 12th positions in the model number)

### Unit Performance Data

Model Number	Cooling			Heating		Unit Dimensions H x W x D Inches (mm)	Operating Weight lbs (kg)
	Capacity BTU/h	SEER	EER	Capacity BTU/h	HSPF		
PHJ424000KTPOA	24,000	14.5	11.5	23,400	8.0	30-1/8 x 51 x 32 (765 x 1295 x 813)	253 (115)
PHJ430000KTPOA	29,800	14.5	11.5	28,600	8.0	34-1/8 x 51 x 32 (867 x 1295 x 813)	283 (128)
PHJ436000KTPOA	36,000	14.5	11.5	34,400	8.0	34-1/8 x 51 x 32 (867 x 1295 x 813)	285 (130)
PHJ442000KTPOA	42,000	14.5	11.5	40,000	8.0	42-1/8 x 51 x 32 (1070 x 1295 x 813)	339 (154)
PHJ448000KTPOA	46,500	14.0	11.5	45,000	8.0	42-1/8 x 51 x 32 (1070 x 1295 x 813)	358 (163)
PHJ460000KTPOA	55,000	14.0	11.0	56,000	8.0	42-1/8 x 51 x 32 (1070 x 1295 x 813)	425 (193)

# Accessories

## PAR5, PHR5, PGR5 Single-Phase Models

Model Number	Description	Use With
<b>Electric Heaters</b>		<b>PHR5</b>
Model	Nominal Capacity (kW) – Fused/Stages	
CPHEATER052B00	3.8 / 5.0 - No / 1	24 - 36
CPHEATER064B00	3.8 / 5.0 - Yes / 1	ALL
CPHEATER069B00	5.4 / 7.2 - No / 2	24
CPHEATER070B00	5.4 / 7.2 - Yes / 2	ALL
CPHEATER050B00	7.5 / 10.0 - Yes / 2	ALL
CPHEATER066B00	11.3 / 15.0 - Yes / 2	30 - 60
CPHEATER054B00	15.0 / 20.0 - Yes / 2	42 - 60
<b>Economizer</b>		<b>PDR5, PAR5</b>
Model	Nominal Capacity (kW)	Use With
ECD-SDSML-JC2-ADB*	Two-stage compatible vertical economizer with Jade Honeywell W7220 controller, Honeywell actuator, and dry bulb sensor.	24 - 30
ECD-SDLGS-JC2-ADB*		36 - 42
ECD-SDLGB-JC2-ADB*		48 - 60
ECH-SDSML-JC2-ADB*	Two-stage compatible horizontal economizer with Jade Honeywell W7220 controller, Honeywell actuator, and dry bulb sensor.	24 - 30
ECH-SDLGS-JC2-ADB*		36 - 42
ECH-SDLGB-JC2-ADB*		48 - 60

\*Contact MicroMetl Customer Service at 1-800-662-4822 to order.

<b>Thermostats</b>		
Model	Description	Use With
TSTAT0408	Universal Programmable Thermostat with Humidity Sensing and Control, Dual Fuel compatible, two-stage cool, two-stage gas heat, two-stage HP heat, two-stage electric heat	ALL
TSTAT0201CW	Observer® Communicating Touchscreen Thermostat with Humidity Sensing and Control, Dual Fuel compatible, two-stage cool, two-stage gas heat, two-stage HP heat, two-stage electric heat	ALL†
NAXA00101DB	Daughter Board, use with communicating thermostat TSTAT0201CW and non-communicating equipment	ALL

\*Relay 1184479 is required with this Low-Ambient Control when used in heat pump application.

†Daughter board required for use with TSTAT0201CW and non-communicating unit.

<b>Curbs</b>		
CPRFCURB011A00	Roof Curb, 14" High	24 - 60
CPRFCURB013A00	Roof Curb, 14" High	36 - 60

Note: CPRFCURB011A00 can be used with 36-60 units with some overhang.

# Accessories

## PAR5, PHR5, PGR5 Single-Phase Models

Model Number	Description	Use with PGR5, PAR5, PHR5
<b>Adapter Curbs*</b>		
CPADCURB001A00	Adapter Curb, for use with NPRFCURB006A00 & NPRFCURB007A00	24 - 30
CPADCURB002A00	Adapter Curb, for use with NPRFCURB008A00 & NPRFCURB009A00	36 - 60
*Can also be used when replacing other manufacturer's older generation units that contain a composite base without a metal base rail.		
<b>Concentric Adaptors (use with curb only)</b>		
NPCONADP001A00	For 18" round duct (*use with curb CPRFCURB011A00)	Small Curb
NPCONADP002A00	For 18" round duct (*use with curb CPRFCURB013A00)	Large Curb
<b>Dampers</b>		
CPMANDPR007A00	Manual Outside Air Damper – (includes filter rack and 1" filter – same as CPFILTRK kit)	24 - 30
CPMANDPR008A00		36 - 42
CPMANDPR009A00		48 - 60
<b>Internal Filter Racks</b>		
CPFILTRK007A00	Internal Filter Rack (includes 1" filters)	24 - 30
CPFILTRK008A00	Internal Filter Rack (includes 1" filters)	36 - 42
CPFILTRK009A00	Internal Filter Rack (includes 1" filters)	48 - 60
<b>Crankcase Heater (factory installed on some models)</b>		
CPCRKHTR008A00	Crankcase Heater	24 - 36
CPCRKHTR004A00	Crankcase Heater	42 - 48
<b>Low-Ambient, Anti-Cycle Timer, Compressor Start Assist</b>		
CPLOWAMB001A00	Low-Ambient Control – Enables cooling system to operate down to 0° F by cycling condenser fan on and off.*	ALL
NRTIMEGD001A00	Five Minute Compressor Delay	ALL
NPHSTART001A00	PTC Compressor Start Assist Kit	ALL
<b>Gas Conversion Kits</b>		
NPLPCONV013C00	Natural to LP Conversion Kit (0 - 2000')	ALL
NPLPCONV014C00	Natural to LP Conversion Kit (2001' - 6000')	ALL
NPNGCONV004B00	LP to Natural Gas Conversion Kit (0 - 2000')	ALL
<b>Flue Discharge Deflector</b>		
CRFLUEDS001A00	Directs flue gas exhaust 90° upward from current discharge. Designed to allow tighter distances between unit and combustible surfaces. 24" height. AGA certified.	ALL
<b>Duct Transitions</b>		
NPDUCFLG002A00	Square to 14" round (one set of two, use with horizontal duct flanges only)	24 - 48
<b>Electric Heaters</b>		<b>PAR5</b>
<b>Model</b>	<b>Nominal Capacity (kW) – Fused/Stages</b>	
CPHEATER052B00	3.8 / 5.0 - No / 1	ALL
CPHEATER064B00	3.8 / 5.0 - Yes / 1	ALL
CPHEATER069B00	5.4 / 7.2 - No / 2	ALL
CPHEATER070B00	5.4 / 7.2 - Yes / 2	ALL
CPHEATER065B00	7.5 / 10.0 - No / 2	24 - 42
CPHEATER050B00	7.5 / 10.0 - Yes / 2	ALL
CPHEATER051B00	11.3 / 15.0 - Yes / 2	30 - 42
CPHEATER066B00	11.3 / 15.0 - Yes / 2	30 - 60
CPHEATER053B00	15.0 / 20.0 - Yes / 2	42
CPHEATER054B00	15.0 / 20.0 - Yes / 2	42 - 60
CPHEATER133B00	11.3 / 15.0 - Yes / 2	30

\*Relay 1184479 is required with this Low-Ambient Control when used in heat pump application.

## PGS4-E, PGD4-E, PDS4-E, PDD4-E, PAD4-E, PHD4-E Single-Phase Models

Model Number	Description	Use With		
		PDS4, PDD4	PGD4, PGS4, PAD4	PHD4
<b>Curbs</b>				
CPRFCURB011A00	Roof Curb, 14" High	24 - 30	24 - 60	24 - 30
CPRFCURB013A00	Roof Curb, 14" High	36 - 60	42 - 60	36 - 60
<b>Note:</b> CPRFCURB011A00 can be used with PGD442-60, PGS442-60, PAD442-60 units with some overhang.				
<b>Adapter Curbs*</b>				
CPADCURB001A00	Adapter Curb, for use with NPRFCURB006A00 and NPRFCURB007A00	24 - 30	24 - 36	24 - 30
CPADCURB002A00	Adapter Curb, for use with NPRFCURB008A00 and NPRFCURB009A00	36 - 60	42 - 60	36 - 60
<b>*Can also be used when replacing other manufacturer's older generation units that contain a composite base without a metal base rail.</b>				
<b>Concentric Adaptors (Use with curb only)</b>				
NPCONADP001A00	For 18" round duct (use with curb CPRFCURB011A00)	Small Curb		
NPCONADP002A00	For 18" round duct (use with curb CPRFCURB013A00)	Large Curb		
<b>Economizers</b>				
CPECOMZR007B00	Dedicated Vertical Economizer – Internal with solid state controller, gear driven, fully modulating damper, spring return actuator, up to 50% barometric relief, supply and dry bulb outdoor air sensors. Includes filter rack with 1" filters.*	24 - 30	24 - 36	24 - 30
CPECOMZR008A00		42, 48	42, 48	42, 48
CPECOMZR009A00		36, 60	60	36, 60
CPECOMZR010A00	Dedicated Horizontal Economizer – Internal with solid state controller, fully modulating damper, spring return actuator, supply and dry bulb outdoor air sensor, and low-ambient compressor lockout switch included. Includes filter rack with 1" filters.*	24 - 30	24 - 36	24 - 30
CPECOMZR011A00		42, 48	42, 48	42, 48
CPECOMZR012A00		36, 60	60	36, 60
CPRLYKIT001A00	Economizer Relay for Heat Pumps	ALL	ALL	ALL
<b>Dampers</b>				
CPMANDPR007A00	Manual Outside Air Damper – Includes filter rack and 1" filter (same as CPFILTRK kit)	24 - 30	24 - 36	24 - 30
CPMANDPR008A00		42, 48	42 - 48	42, 48
CPMANDPR009A00		36, 60	60	36, 60
<b>Internal Filter Racks</b>				
CPFILTRK007A00	Internal Filter Rack (includes 1" filters)	24 - 30	24 - 36	24 - 30
CPFILTRK008A00	Internal Filter Rack (includes 1" filters)	42, 48	42, 48	42, 48
CPFILTRK009A00	Internal Filter Rack (includes 1" filters)	36, 60	60	36, 60
<b>Low-Ambient, Anti-Cycle Timer, Compressor Start Assist</b>				
CPLOWAMB001A00*	Low-Ambient Control – Enables cooling system to operate down to 0° F by cycling condenser fan on and off.*	ALL	ALL	ALL
NRTIMEGD001A00	Five Minute Compressor Delay	ALL	ALL	ALL
NPHSTART002A00	PTC Compressor Start Assist Kit	ALL	ALL	ALL
<b>Crankcase Heater - Belly Band Type</b>				
CPCRKHTR008A00	240V Crankcase Heater	24 - 36	24, 36	24 - 36
CPCRKHTR004A00	240V Crankcase Heater (included on 48 and 60 size models)	42 - 60	30, 42 - 60	42 - 60
<b>Gas Conversion Kits</b>				
NPLPCONV013C00	Natural to LP Conversion Kit (0 - 2000')	ALL	ALL	ALL
NPLPCONV014C00	Natural to LP Conversion Kit (2001' - 6000')	ALL	ALL	ALL
NPNGCONV004C00	LP to Natural Gas Conversion Kit (0 - 2000')	ALL	ALL	ALL

\*Relay 1184479 is required with this Low-Ambient Control when used in heat pump application.

# Accessories

## PGS4-E, PGD4-E, PDS4-E, PDD4-E, PAD4-E, PHD4-E Single-Phase Models

Model Number	Description	Use With		
		PDS4, PDD4	PGD4, PGS4, PAD4	PHD4
<b>Flue Discharge Deflector</b>				
CRFLUEDS001A00	Directs flue gas exhaust 90° upward from current discharge. Designed to allow tighter distances between unit and combustible surfaces. 24" height. AGA certified.	ALL	ALL	ALL
<b>Duct Transitions</b>				
NPDUCFLG002A00	Square to 14" round (one set of two, use with horizontal duct flanges only)	24 - 48	24 - 48	24 - 48
<b>Low-Pressure Switch</b>				
CPLPSTL001A00	Low-Pressure Switch Kit (standard on 24 size)	–	30 - 60	–
<b>Factory Installed on PGS4 and PAD4 "TP" Models</b>				
NAPA00501GR	3/8" spacing dense wire grilles 14"	–	24	–
NAPA00701GR	3/8" spacing dense wire grilles 16"	–	30	–
NAPA01401GR	3/8" spacing dense wire grilles 22"	–	36	–
NAPA00601GR	3/8" spacing dense wire grilles 14"	–	42	–
NAPA01201GR	3/8" spacing dense wire grilles 16"	–	48	–
NAPA01301GR	3/8" spacing dense wire grilles 24"	–	60	–
<b>Factory Installed on PDS4 and PHD4 "TP" Models</b>		<b>PDD4</b>		
NAPA00901GR	3/8" spacing dense wire grilles 18"	24	–	24
NAPA01401GR	3/8" spacing dense wire grilles 22"	30		30
NAPA01001GR	3/8" spacing dense wire grilles 18"	36	–	36
NAPA01301GR	3/8" spacing dense wire grilles 24"	42 - 48	–	42 - 48
NAPA01001GR	3/8" spacing dense wire grilles 18"	60		60
<b>Electric Heaters – PAD4</b>				
<b>Model</b>	<b>Nominal Capacity (kW)</b>			
CPHEATER052B00	3.8 / 5.0	–	ALL	
CPHEATER064B00	3.8 / 5.0	–	ALL	
CPHEATER069B00	5.4 / 7.2	–	ALL	
CPHEATER070B00	5.4 / 7.2	–	ALL	
CPHEATER065B00	7.5 / 10.0	–	24 - 42	
CPHEATER050B00	7.5 / 10.0	–	ALL	
CPHEATER051B00	11.3 / 15.0	–	30 - 42	
CPHEATER066B00	11.3 / 15.0	–	30 - 60	
CPHEATER053B00	15.0 / 20.0	–	42	
CPHEATER054B00	15.0 / 20.0	–	42 - 60	
<b>Electric Heaters – PHD4</b>				
<b>Model</b>	<b>Nominal Capacity (kW)</b>			
CPHEATER052B00	3.8 / 5.0	–		24 - 36
CPHEATER064B00	3.8 / 5.0	–		ALL
CPHEATER069B00	5.4 / 7.2	–		24
CPHEATER070B00	5.4 / 7.2	–		ALL
CPHEATER050B00	7.5 / 10.0	–		ALL
CPHEATER066B00	11.3 / 15.0	–		30 - 60
CPHEATER054B00	15.0 / 20.0	–		42 - 60
CPHEATER133B00	11.3 / 15.0	–	24, 30	30

\*Relay 1184479 is required with this Low-Ambient Control when used in heat pump application.

Specifications subject to change without notice.



# Accessories

## PAJ4, PHJ4 Single-Phase Models

Model Number	Description	Use With	
		PAJ4	PHJ4
<b>Compressor Start Kit</b>			
CPHSTART002A00	Compressor Start Kit assists compressor start-up by providing additional starting torque on single-phase units only.	ALL	ALL
<b>Crankcase Heater</b>			
CPCRKHTR008A00	Crankcase Heater provides anti-floodback protection for low-load cooling applications (240V)	24 - 36	24 - 36
CPCRKHTR004A00	Crankcase Heater provides anti-floodback protection for low-load cooling applications (240V)	42 - 60	42 - 60
<b>Low-Ambient Kit</b>			
CPLOWAMB001A00	Low-Ambient Kit (Motormaster II Control) allows the use of mechanical cooling system to operate down to 0° F (-18° C) when properly installed	ALL	ALL
<b>Time Guard II</b>			
NRTIMEGD001A00	Automatically prevents the compressor from restarting for at least 4 minutes and 45 seconds after shutdown of the compressor. Not required when a corporate programmable thermostat is applied.	ALL	ALL
<b>Accessory Electric Heaters</b>			
Model	Nominal Capacity (kW)	PAJ4	PHJ4
CPHEATER125A03	3.8 / 5.0 (no circuit breaker)	24 - 60	24 - 48
CPHEATER126A03	3.8 / 5.0	24 - 60	24 - 60
CPHEATER127A03	5.6 / 7.5 (no circuit breaker) Two-Stages	24 - 60	24
CPHEATER128A03	5.6 / 7.5 Two-Stages	24 - 60	24 - 60
CPHEATER129A03	7.5 / 10.0 (no circuit breaker) Two-Stages	24 - 48	NONE
CPHEATER130A03	7.5 / 10.0 Two-Stages	24 - 48	24 - 60
CPHEATER131A03	11.3 / 15.0 Two-Stages	36 - 60	36 - 60
CPHEATER132A03	15.0 / 20.0 Two-Stages	48 - 60	48 - 60



# Controls and Indoor Air Quality



# SYST0101CW

## ION™ Communicating System Control

The Ion™ System Control is the ultimate control center for all of your system components. When you add an Ion System Control to a compatible variable-speed furnace, fan coil, split system, you will enjoy longer heating and cooling cycles at lower fan speeds for a more consistent temperature throughout your home. By adding a multi-staged, or two-stage outdoor unit, you will enjoy extra benefits which include better humidity and temperature control, as well as a more energy-efficient comfort system. When paired with Ion Zoning, the Ion System Control allows you to create up to eight zones of customized comfort. The Ion Zoning system does not require a bypass damper, leaving air temperature (LAT) sensor, or field-installed power transformer.



### Features

- Two-wire connection to Ion System two or more -stage outdoor equipment
- Four-wire installation from each major component in the system
- Advanced humidity control settings are the default; no longer requiring increased system setup
- Complete integration of the temperature and humidity in every season
- Auto mode selection to satisfy simultaneous heating and cooling demands via more aggressive Auto Changeover algorithm — installer must enable
- Seven-day programmability with Lifestyle Comfort Profiles and activity features; complies with California Title 24 programmability requirements
- Upload photo, dealer info, and software updates locally via MicroSD card. Software updates available automatically when connected to the icpusa.com web server
- Compatible with home automation systems via Amazon™ Alexa™ control
- Day-at-a-glance programming for simplified ease of use
- Ion Zoning System compatibility
- Dirty Filter Detection
- Programmable fan by period
- Wi-Fi® remote access capability

### Limited Warranty\*

- 10-year parts, for the control, to original purchaser upon timely registration, otherwise 5-years
- Two-year parts for the wireless access point to original purchaser only

Description	Model Number
Ion™ System Control (Wi-Fi®)	SYST0101CW

NOTE: The Ion™ Zoning System IS NOT compatible with all ICP™ communicating indoor equipment. See the Ion System Control product data for more information.

NOTE: Only use modulating dampers provided by ICP for use with the Ion Zoning System. Dampers provided by other companies are NOT compatible with the Ion Zoning System.

NOTE: Observer® System accessories, except for certain dampers (see damper list), are NOT compatible with the Ion Zoning System. Use the Observer Zoning System, or equivalent, for non-compatible indoor units, such as non-communicating indoor units. The Observer Zoning System may also be used in retrofit applications where it is impractical to change existing zone dampers.

All trademarks are the property of their respective owners. Wi-Fi® is a trademark of Wi-Fi Alliance Corporation.

# Accessories - SYST0101CW

## CONTROLS

Part Number	Description
SYST0101RM*	Ion™ Communicating Relay Module (CRM)

\* Required for dual fuel applications with non-communicating heat pumps, and for use with two-stage, non communicating AC or HP.

## ZONING CONTROLS

Part Number	Description
SYST0101ZP†	Ion™ Zoning System Damper Control Module (4-Zone)

NOTE: Each piece of the zoning equipment is purchased separately allowing for customization of the zoning application.

† One Damper Control Module for up to four zones.  
A second Damper Control Module is required for Zones 5–8.

## OPTIONAL ACCESSORIES

Part Number	Description
SYSTXIIRRS01*	Ion™ Remote Room Sensor - Wired (RRS)
SYSTXNNWTP06†	Decorative Trim Plate - White (6-pack)
SYSTXNNBTP06†	Decorative Trim Plate - Black (6-pack)
SYSTXNNSTP06†	Decorative Trim Plate - Silver (6-pack)
SYSTXGXRPLG10	Equipment Communication Connector (DX+, DX-, C, R Plug; 10-pack)
TSTATXXSEN01-B	Outdoor Air Temperature Sensor

\* Not required for Zone 1, but may be used to remote sense indoor room temperature.

† Backplate dimensions: 6.83 in. (173.5mm) wide x 5.97 in. (151.7mm) high

## ZONING ACCESSORIES & REPLACEMENT PARTS

Part Number	Description
ZONEXXODTS01	Duct temperature sensor
ZDAMPACT45DEG-R	45° Actuator for round dampers
ZDAMPACT90DEG-R	90° Actuator for rectangular dampers
ATO1*	Damper Control Module 1-amp Fuse

\*Ordered from and warehoused by RC/Fast Parts

## ROUND DAMPERS

Part Number	Description
ZDAMPRND06INCB	6 in.
ZDAMPRND08INCB	8 in.
ZDAMPRND10INCB	10 in.
ZDAMPRND12INCB	12 in.
ZDAMPRND14INCB	14 in.
ZDAMPRND16INCB	16 in.

## RECTANGULAR DAMPERS

Part Number	Description
ZDAMPREC08X10B	8 in. X 10 in.
ZDAMPREC08X14B	8 in. X 14 in.
ZDAMPREC08X18B	8 in. X 18 in.
ZDAMPREC08X24B	8 in. X 24 in.
ZDAMPREC10X10B	10 in. X 10 in.
ZDAMPREC10X14B	10 in. X 14 in.
ZDAMPREC10X18B	10 in. X 18 in.
ZDAMPREC10X24B	10 in. X 24 in.

## SLIP-IN DAMPERS

Part Number	Description
DAMPPLS08X08-B	Side mount, 8 X 8
DAMPPLB08X08-B	Bottom mount, 8 X 8
DAMPPLS08X10-B	Side mount, 8 X 10
DAMPPLB08X10-B	Bottom mount, 8 X 10
DAMPPLS08X12-B	Side mount, 8 X 12
DAMPPLB08X12-B	Bottom mount, 8 X 12
DAMPPLS08X14-B	Side mount, 8 X 14
DAMPPLB08X14-B	Bottom mount, 8 X 14
DAMPPLS08X16-B	Side mount, 8 X 16
DAMPPLB08X16-B	Bottom mount, 8 X 16
DAMPPLS08x18-B	Side mount, 8 X 18
DAMPPLB08X18-B	Bottom mount, 8 X 18
DAMPPLS08X20-B	Side mount, 8 X 20
DAMPPLB08X20-B	Bottom mount, 8 X 20
DAMPPLS08X22-B	Side mount, 8 X 22
DAMPPLB08X22-B	Bottom mount, 8 X 22
DAMPPLS08X24-B	Side mount, 8 X 24
DAMPPLB08X24-B	Bottom mount, 8 X 24
DAMPPLS10X10-B	Side mount, 10 X 10
DAMPPLB10X10-B	Bottom mount, 10 X 10
DAMPPLS10X12-B	Side mount, 10 X 12
DAMPPLB10X12-B	Bottom mount, 10 X 12
DAMPPLS10X14-B	Side mount, 10 X 14
DAMPPLB10X14-B	Bottom mount, 10 X 14
DAMPPLS10X16-B	Side mount, 10 X 16
DAMPPLB10X16-B	Bottom mount, 10 X 16
DAMPPLS10X18-B	Side mount, 10 X 18
DAMPPLB10X18-B	Bottom mount, 10 X 18
DAMPPLS10X20-B	Side mount, 10 X 20
DAMPPLB10X20-B	Bottom mount, 10 X 20
DAMPPLS10X22-B	Side mount, 10 X 22
DAMPPLB10X22-B	Bottom mount, 10 X 22
DAMPPLS10X24-B	Side mount, 10 X 24
DAMPPLB10X24-B	Bottom mount, 10 X 24
DAMPPLS12X12-B	Side mount, 12 X 12
DAMPPLB12X12-B	Bottom mount, 12 X 12
DAMPPLS12X14-B	Side mount, 12 X 14
DAMPPLB12X14-B	Bottom mount, 12 X 14
DAMPPLS12X16-B	Side mount, 12 X 16
DAMPPLB12X16-B	Bottom mount, 12 X 16
DAMPPLS12X18-B	Side mount, 12 X 18
DAMPPLB12X18-B	Bottom mount, 12 X 18
DAMPPLS12X20-B	Side mount, 12 X 20
DAMPPLB12X20-B	Bottom mount, 12 X 20
DAMPPLS14X14-B	Side mount, 14 X 14
DAMPPLB14X14-B	Bottom mount, 14 X 14
DAMPPLS14X16-B	Side mount, 14 X 16
DAMPPLB14X16-B	Bottom mount, 14 X 16
DAMPPLS14X20-B	Side mount, 14 X 20
DAMPPLB14X20-B	Bottom mount, 14 X 20
DAMPPLS16X16-B	Side mount, 16 X 16
DAMPPLB16X16-B	Bottom mount, 16 X 16
DAMPPLB16X20-B	Bottom mount, 16 X 20

# TSTAT0201CW

## Color Touchscreen Communicating Wall Control



### Wi-Fi® Compatible

#### For use in Single- or Multi-Zone Installations

(Requires a complete Observer® Zoning System and Version 4.02 software or later)

### Features

- Supports Observer System communicating equipment multi-stage heating and cooling operation, including modulating gas furnaces (version 4.02 and later) and inverter compressor sections (ODUs; version 5.02 and later). **NOTE:** The TSTAT0101SC wall control DOES NOT support inverter compressor sections.
- TSTAT0201CW features Remote Access via home Wi-Fi network; see [www.MyObserverComfort.com](http://www.MyObserverComfort.com) for more information and access to iOS and Android mobile apps
- Four-wire (or two-/three-wire depending on the communicating outdoor unit used) installation from each compatible component in the system
- Self configuration with all compatible components in the system
- Simplified programming with options for four daily periods during individual days, all days same, or weekday/weekend schedule; California Title 24 compliant
- Option to use NAXA00101DB Daughter Board for connection with non-communicating system components (single or multi-zone installations)
- Selectable screen backlight brightness, including 30% off
- Supports up to four-stage Heat, two-stage Cool for non-communicating equipment
- Adjustable/resettable filter and service reminders
- High-definition, full-color touchscreen display; QWERTY keyboard for data entry
- Communication with all compatible components in the system
- Enter dealer name and contact info for display during a fault
- Text based diagnostics viewable on screen

### Warranty\*

- 10-year No Hassle Replacement™ limited warranty
- 10-year parts limited warranty
  - With timely registration, an additional five-year parts limited warranty

\* For residential applications only.  
See warranty certificate for complete details and restrictions, including warranty coverage for other applications.

Model Number	Description
TSTAT0201CW	Observer® Wireless Wall Control

\*Available through the Literature Ordering System

# Accessories - TSTAT0201CW

Part Number	Description
NAXA00101WA	Observer® Wireless Access Point for use with TSTAT0201CW model wall control. Provides gateway/router services to an Observer Wi-Fi® network if other Wi-Fi networks are unavailable or unusable. Connects to an existing Ethernet network that provides Internet access. DOES NOT add Wi-Fi capability to the TSTAT0101SC model wall control.
TSTATXXSEN01B	Outdoor Temperature Sensor, use with non-communicating equipment (communicating outdoor equipment factory equipped with OD Temperature Sensor)
TXMBP01	Backplate, medium size. Covers wall spots left when replacing larger thermostats.
SYSTXGRPLG10	Communicating Plug, four-wire (DX+, DX-, C, R). Matches connector on control board of communicating indoor and outdoor equipment, 10 pack.
SYSTXIIRRS01	Remote Room Sensor (not required), requires two-wire stat cable, use one or four with Observer control for optional remote temperature sensing (temperatures averaged). (Use ZONE0101RRS as the zone temperature sensor in zoning applications)
<b>Zoning Accessories</b>	
ZONE0101ZP6	Observer Zone Panel supports up to six zones and provides basic relay logic for damper operation and serves as the common connection point for the Observer Zoning System.
ZONE0101RRS	Observer Communicating Room Sensor is a Zone Sensor option for Zones 2 through 6. It provides full setback capabilities (through the Observer wall control interface only) and communicates to Observer Zoning System.
ZONEXXODTS01	Leaving Air Temperature (LAT) Sensor provides temperature readings to the zoning system to optimize performance and to protect the equipment.
ZDAMPRND06INCB	Round Dampers, 6" power open, power closed damper with self-aligning shaft and actuator hub
ZDAMPRND08INCB	Round Dampers, 8" power open, power closed damper with self-aligning shaft and actuator hub
ZDAMPRND10INCB	Round Dampers, 10" power open, power closed damper with self-aligning shaft and actuator hub
ZDAMPRND12INCB	Round Dampers, 12" power open, power closed damper with self-aligning shaft and actuator hub
ZDAMPRND14INCB	Round Dampers, 8" x 14" power open, power closed damper with self-aligning shaft and actuator hub
ZDAMPRND16INCB	Round Dampers, 16" power open, power closed damper with self-aligning shaft and actuator hub
ZDAMPREC08X10B	Rectangular Dampers, 8" x 10" power open, power closed damper with self-aligning shaft and actuator hub
ZDAMPREC08X14B	Rectangular Dampers, 8" x 14" power open, power closed damper with self-aligning shaft and actuator hub
ZDAMPREC08X18B	Rectangular Dampers, 8" x 18" power open, power closed damper with self-aligning shaft and actuator hub
ZDAMPREC08X24B	Rectangular Dampers, 8" x 24" power open, power closed damper with self-aligning shaft and actuator hub
ZDAMPREC10X10B	Rectangular Dampers, 10" x 10" power open, power closed damper with self-aligning shaft and actuator hub
ZDAMPREC10X14B	Rectangular Dampers, 10" x 14" power open, power closed damper with self-aligning shaft and actuator hub
ZDAMPREC10X18B	Rectangular Dampers, 10" x 18" power open, power closed damper with self-aligning shaft and actuator hub
ZDAMPREC10X24B	Rectangular Dampers, 10" x 24" power open, power closed damper with self-aligning shaft and actuator hub
ZDAMPBAR8X14	Rectangular Barometric Bypass, 8" x 14" power open, power closed damper with self-aligning shaft and actuator hub
ZDAMPBAR8X24	Rectangular Barometric Bypass, 8" x 24" power open, power closed damper with self-aligning shaft and actuator hub
ZDAMPACT45DEGR	45° Replacement Actuator for Round Dampers
ZDAMPACT90DEGR	90° Replacement Actuator for Round Dampers

# TSTAT0408



## TSTAT0408 Features

- Seven-day programming
- Dual Fuel System Management
- Four-wire capability with daughter board
- Four-stage Heat, two-stage Cool
- Auto changeover
- Digital dealer contact info display
- Blue backlit display
- Humidity control
- Option to make "H" terminal energized for dehum or de-energized for dehum

## Warranty\*

- Five-year parts limited warranty

\* For residential applications only.

See warranty certificate for complete details and restrictions, including warranty coverage for other applications.



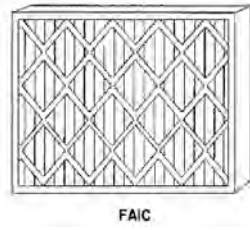
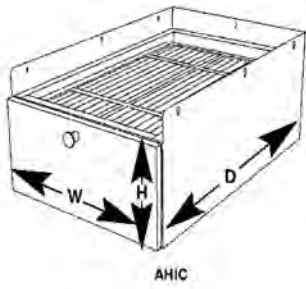

# AHIC & FAIC

## Fan Coil Media Cleaner

2 – 5 Tons  
208 / 230 Volt, Single-Phase, 60 Hz

### AHIC Media Cabinet

#### EFFICIENCY

- Minimum Efficiency Reporting Value as specified by ASHRAE is MERV 8

#### EASY FILTER ACCESS

- AHIC media cabinet allows easy filter access on fan coil systems

#### IMPROVED INDOOR AIR QUALITY (IAQ)

- When used with high-efficiency FAIC filter, the AHIC media cabinet provides improved IAQ

#### TROUBLE FREE INSTALLATION

- No electricity required

#### NEARLY MAINTENANCE FREE OPERATION

- Only maintenance required is replacing media filter cartridge when needed (before each heating or cooling season)

### FAIC Media Filter Cartridge

#### EFFICIENCY

- Minimum Efficiency Reporting Value as specified by ASHRAE is MERV 8, minimum of 70% particle collection efficiency in the 3-10 micron particle size

#### LARGE DUST HOLDING CAPACITY

- Filters accommodate between 13 and 25 sq. ft. of filter media into a low-pressure drop design - providing large dust holding capacities
- Large surface area traps dust, pollen, molds, tobacco smoke, grease, soot, bacteria, and animal dander to provide cleaner, fresher air

#### EXCEPTIONAL SYSTEM PERFORMANCE

- For optimum system performance use the AHIC with FAIC high efficiency media

### Unit Performance Data

Model Number	CFM	Unit Dimensions H x W x D Inches (mm)
AHIC0014A	900	7.008 x 14.293 x 22.143 (178 x 363 x 562)
AHIC0017A	1350	7.008 x 17.620 x 22.143 (178 x 448 x 562)
AHIC0021A	2000	7.008 x 21.124 x 22.143 (178 x 537 x 562)
AHIC0024A	2200	7.008 x 24.620 x 22.143 (178 x 625 x 562)
FAIC0014A02	13.05 sq.ft.	19.8125 x 12.175 x 4.3125 (503 x 309 x 110)
FAIC0017A02	17.8 sq. ft.	19.8125 x 12.175 x 4.3125 (503 x 309 x 110)
FAIC0021A02	20.17 sq. ft.	19.8125 x 12.175 x 4.3125 (503 x 309 x 110)
FAIC0024A02	24.9 sq. ft.	19.8125 x 12.175 x 4.3125 (503 x 309 x 110)



# Geothermal



# HP

## R410-A Geothermal Package Heat Pump

2 – 6 Ton



### Easier to Sell

- 3.5 - 4.0 COP, 15.5 - 24.5 EER (Closed Loop)
- 4.0 - 4.6 COP, 19.6 - 30.0 EER (Open Loop)
- 2" filter, MERV 8
- Unit available in vertical upflow, downflow and horizontal
- Compressor blanket
- Fully insulated cabinet with closed cell foam
- Optional supplemental domestic water heating
- Optional cupro-nickel heat exchanger for open loop applications

### Warranty\*

- Five-year No Hassle Replacement™ limited warranty
- Five-year labor limited warranty
  - With timely registration, an additional five-year labor limited warranty
- 10-year parts limited warranty (including compressor)

\* For residential applications only (owner occupied for No Hassle warranty).  
See warranty certificate for complete details and restrictions, including warranty coverage for other applications.

### Tougher

- Two-stage scroll compressor
- Variable-speed ECM blower motor
- Tin-plated copper tubing in air coil

### Easier to Install and Service

- Compatible with many three-stage heat, two-stage cooling programmable thermostats
- Microprocessor control



Qualifying models only.

### Unit Performance Data

Model Number	Size (tons)	Nominal Btu/hr	Min. Circuit Ampacity	Max. Fuse or Breaker	Dimensions H x W x D (sq) in.
HPO24CBLCDT1XX1	2	24,000	17.4	25	47-1/4 X 21-1/2 X 26
HPO24CBLCXET1XX1	2	24,000	17.4	25	47-1/4 X 21-1/2 X 26
HPO24CBLNDET1XX1	2	24,000	17.4	25	47-1/4 X 21-1/2 X 26
HPO24CBLNXET1XX1	2	24,000	17.4	25	47-1/4 X 21-1/2 X 26
HPO24CBRCDET1XX1	2	24,000	17.4	25	47-1/4 X 21-1/2 X 26
HPO24CBRCXET1XX1	2	24,000	17.4	25	47-1/4 X 21-1/2 X 26
HPO24CBRNDET1XX1	2	24,000	17.4	25	47-1/4 X 21-1/2 X 26
HPO24CBRNXET1XX1	2	24,000	17.4	25	47-1/4 X 21-1/2 X 26
HPO24HELCDT1XX1	2	24,000	17.4	25	21-3/4 X 26 X 54-1/2
HPO24HELCXET1XX1	2	24,000	17.4	25	21-3/4 X 26 X 54-1/2
HPO24HELNDET1XX1	2	24,000	17.4	25	21-3/4 X 26 X 54-1/2
HPO24HELNXET1XX1	2	24,000	17.4	25	21-3/4 X 26 X 54-1/2
HPO24HERCDT1XX1	2	24,000	17.4	25	21-3/4 X 26 X 54-1/2
HPO24HERCXET1XX1	2	24,000	17.4	25	21-3/4 X 26 X 54-1/2
HPO24HERNDET1XX1	2	24,000	17.4	25	21-3/4 X 26 X 54-1/2
HPO24HERNXET1XX1	2	24,000	17.4	25	21-3/4 X 26 X 54-1/2
HPO24HSLCDT1XX1	2	24,000	17.4	25	21-3/4 X 26 X 54-1/2
HPO24HSLCXET1XX1	2	24,000	17.4	25	21-3/4 X 26 X 54-1/2
HPO24HSLNDET1XX1	2	24,000	17.4	25	21-3/4 X 26 X 54-1/2
HPO24HSLNXET1XX1	2	24,000	17.4	25	21-3/4 X 26 X 54-1/2
HPO24HSRCDET1XX1	2	24,000	17.4	25	21-3/4 X 26 X 54-1/2
HPO24HSRCXET1XX1	2	24,000	17.4	25	21-3/4 X 26 X 54-1/2
HPO24HSRNDET1XX1	2	24,000	17.4	25	21-3/4 X 26 X 54-1/2
HPO24HSRNXET1XX1	2	24,000	17.4	25	21-3/4 X 26 X 54-1/2
HPO24VTLCDT1XX1	2	24,000	17.4	25	47-1/4 X 21-1/2 X 26
HPO24VTLCXET1XX1	2	24,000	17.4	25	47-1/4 X 21-1/2 X 26
HPO24VTLNDET1XX1	2	24,000	17.4	25	47-1/4 X 21-1/2 X 26
HPO24VTLNXET1XX1	2	24,000	17.4	25	47-1/4 X 21-1/2 X 26

Unit Performance Data



Model Number	Size (tons)	Nominal Btu/hr	Min. Circuit Ampacity	Max. Fuse or Breaker	Dimensions H x W x D (sq) in.
HP024VTRCDET1XX1	2	24,000	17.4	25	47-1/4 X 21-1/2 X 26
HP024VTRCXET1XX1	2	24,000	17.4	25	47-1/4 X 21-1/2 X 26
HP024VTRNDET1XX1	2	24,000	17.4	25	47-1/4 X 21-1/2 X 26
HP024VTRNXET1XX1	2	24,000	17.4	25	47-1/4 X 21-1/2 X 26
HP036CBLCDET1XX1	3	36,000	23.4	35	47-1/4 X 21-1/2 X 26
HP036CBLCXET1XX1	3	36,000	23.4	35	47-1/4 X 21-1/2 X 26
HP036CBLNDET1XX1	3	36,000	23.4	35	47-1/4 X 21-1/2 X 26
HP036CBLNXET1XX1	3	36,000	23.4	35	47-1/4 X 21-1/2 X 26
HP036CBRCDET1XX1	3	36,000	23.4	35	47-1/4 X 21-1/2 X 26
HP036CBRCXET1XX1	3	36,000	23.4	35	47-1/4 X 21-1/2 X 26
HP036CBRNDET1XX1	3	36,000	23.4	35	47-1/4 X 21-1/2 X 26
HP036CBRNXET1XX1	3	36,000	23.4	35	47-1/4 X 21-1/2 X 26
HP036HELCDDET1XX1	3	36,000	23.4	35	21-3/4 X 26 X 54-1/2
HP036HELXCXET1XX1	3	36,000	23.4	35	21-3/4 X 26 X 54-1/2
HP036HELNDET1XX1	3	36,000	23.4	35	21-3/4 X 26 X 54-1/2
HP036HELNXET1XX1	3	36,000	23.4	35	21-3/4 X 26 X 54-1/2
HP036HERCDET1XX1	3	36,000	23.4	35	21-3/4 X 26 X 54-1/2
HP036HERCXET1XX1	3	36,000	23.4	35	21-3/4 X 26 X 54-1/2
HP036HERNDET1XX1	3	36,000	23.4	35	21-3/4 X 26 X 54-1/2
HP036HERNXET1XX1	3	36,000	23.4	35	21-3/4 X 26 X 54-1/2
HP036HSLCDET1XX1	3	36,000	23.4	35	21-3/4 X 26 X 54-1/2
HP036HSLCXET1XX1	3	36,000	23.4	35	21-3/4 X 26 X 54-1/2
HP036HSLNDET1XX1	3	36,000	23.4	35	21-3/4 X 26 X 54-1/2
HP036HSLNXET1XX1	3	36,000	23.4	35	21-3/4 X 26 X 54-1/2
HP036HSRCDET1XX1	3	36,000	23.4	35	21-3/4 X 26 X 54-1/2
HP036HSRCXET1XX1	3	36,000	23.4	35	21-3/4 X 26 X 54-1/2
HP036HSRNDET1XX1	3	36,000	23.4	35	21-3/4 X 26 X 54-1/2
HP036HSRNXET1XX1	3	36,000	23.4	35	21-3/4 X 26 X 54-1/2
HP036VTLCDET1XX1	3	36,000	23.4	35	47-1/4 X 21-1/2 X 26
HP036VTLCXET1XX1	3	36,000	23.4	35	47-1/4 X 21-1/2 X 26
HP036VTLNDET1XX1	3	36,000	23.4	35	47-1/4 X 21-1/2 X 26
HP036VTLNXET1XX1	3	36,000	23.4	35	47-1/4 X 21-1/2 X 26
HP036VTRCDET1XX1	3	36,000	23.4	35	47-1/4 X 21-1/2 X 26
HP036VTRCXET1XX1	3	36,000	23.4	35	47-1/4 X 21-1/2 X 26
HP036VTRNDET1XX1	3	36,000	23.4	35	47-1/4 X 21-1/2 X 26
HP036VTRNXET1XX1	3	36,000	23.4	35	47-1/4 X 21-1/2 X 26
HP048CBLCDET1XX1	4	48,000	33.3	50	47-1/4 X 24 X 32-3/4
HP048CBLCXET1XX1	4	48,000	33.3	50	47-1/4 X 24 X 32-3/4
HP048CBLNDET1XX1	4	48,000	33.3	50	47-1/4 X 24 X 32-3/4
HP048CBLNXET1XX1	4	48,000	33.3	50	47-1/4 X 24 X 32-3/4
HP048CBRCDET1XX1	4	48,000	33.3	50	47-1/4 X 24 X 32-3/4
HP048CBRCXET1XX1	4	48,000	33.3	50	47-1/4 X 24 X 32-3/4
HP048CBRNDET1XX1	4	48,000	33.3	50	47-1/4 X 24 X 32-3/4
HP048CBRNXET1XX1	4	48,000	33.3	50	47-1/4 X 24 X 32-3/4

# HP

Model Number	Size (tons)	Nominal Btu/hr	Min. Circuit Ampacity	Max. Fuse or Breaker	Dimensions H x W x D (sq) in.
HP048HELCDDET1XX1	4	48,000	33.3	50	21-3/4 X 30 X 68
HP048HELCXET1XX1	4	48,000	33.3	50	21-3/4 X 30 X 68
HP048HELNDDET1XX1	4	48,000	33.3	50	21-3/4 X 30 X 68
HP048HELNJET1XX1	4	48,000	33.3	50	21-3/4 X 30 X 68
HP048HERCDET1XX1	4	48,000	33.3	50	21-3/4 X 30 X 68
HP048HERCXET1XX1	4	48,000	33.3	50	21-3/4 X 30 X 68
HP048HERNDET1XX1	4	48,000	33.3	50	21-3/4 X 30 X 68
HP048HERNXET1XX1	4	48,000	33.3	50	21-3/4 X 30 X 68
HP048HSLCDET1XX1	4	48,000	33.3	50	21-3/4 X 30 X 68
HP048HSLCXET1XX1	4	48,000	33.3	50	21-3/4 X 30 X 68
HP048HSLNDET1XX1	4	48,000	33.3	50	21-3/4 X 30 X 68
HP048HSLNJET1XX1	4	48,000	33.3	50	21-3/4 X 30 X 68
HP048HSRCDET1XX1	4	48,000	33.3	50	21-3/4 X 30 X 68
HP048HSRCXET1XX1	4	48,000	33.3	50	21-3/4 X 30 X 68
HP048HSRNDDET1XX1	4	48,000	33.3	50	21-3/4 X 30 X 68
HP048HSRNJET1XX1	4	48,000	33.3	50	21-3/4 X 30 X 68
HP048VTLCDDET1XX1	4	48,000	33.3	50	47-1/4 X 24 X 32-3/4
HP048VTLCXET1XX1	4	48,000	33.3	50	47-1/4 X 24 X 32-3/4
HP048VTLNDET1XX1	4	48,000	33.3	50	47-1/4 X 24 X 32-3/4
HP048VTLNJET1XX1	4	48,000	33.3	50	47-1/4 X 24 X 32-3/4
HP048VTRCDET1XX1	4	48,000	33.3	50	47-1/4 X 24 X 32-3/4
HP048VTRCXET1XX1	4	48,000	33.3	50	47-1/4 X 24 X 32-3/4
HP048VTRNDET1XX1	4	48,000	33.3	50	47-1/4 X 24 X 32-3/4
HP048VTRNJET1XX1	4	48,000	33.3	50	47-1/4 X 24 X 32-3/4
HP060CBLCDDET1XX1	5	60,000	43.0	70	51-1/4 X 26 X 32-1/4
HP060CBLCXET1XX1	5	60,000	43.0	70	51-1/4 X 26 X 32-1/4
HP060CBLNDET1XX1	5	60,000	43.0	70	51-1/4 X 26 X 32-1/4
HP060CBLNJET1XX1	5	60,000	43.0	70	51-1/4 X 26 X 32-1/4
HP060CBRCDET1XX1	5	60,000	43.0	70	51-1/4 X 26 X 32-1/4
HP060CBRCXET1XX1	5	60,000	43.0	70	51-1/4 X 26 X 32-1/4
HP060CBRNDDET1XX1	5	60,000	43.0	70	51-1/4 X 26 X 32-1/4
HP060CBRNJET1XX1	5	60,000	43.0	70	51-1/4 X 26 X 32-1/4
HP060HELCDDET1XX1	5	60,000	43.0	70	21-3/4 X 30 X 68
HP060HELCXET1XX1	5	60,000	43.0	70	21-3/4 X 30 X 68
HP060HELNDDET1XX1	5	60,000	43.0	70	21-3/4 X 30 X 68
HP060HELNJET1XX1	5	60,000	43.0	70	21-3/4 X 30 X 68
HP060HERCDET1XX1	5	60,000	43.0	70	21-3/4 X 30 X 68
HP060HERCXET1XX1	5	60,000	43.0	70	21-3/4 X 30 X 68
HP060HERNDET1XX1	5	60,000	43.0	70	21-3/4 X 30 X 68
HP060HERNXET1XX1	5	60,000	43.0	70	21-3/4 X 30 X 68
HP060HSLCDET1XX1	5	60,000	43.0	70	21-3/4 X 30 X 68
HP060HSLCXET1XX1	5	60,000	43.0	70	21-3/4 X 30 X 68
HP060HSLNDET1XX1	5	60,000	43.0	70	21-3/4 X 30 X 68
HP060HSLNJET1XX1	5	60,000	43.0	70	21-3/4 X 30 X 68

Model Number	Size (tons)	Nominal Btu/hr	Min. Circuit Ampacity	Max. Fuse or Breaker	Dimensions H x W x D (sq) in.
HP060HSRCDET1XX1	5	60,000	43.0	70	21-3/4 X 30 X 68
HP060HSRCXET1XX1	5	60,000	43.0	70	21-3/4 X 30 X 68
HP060HSRNDDET1XX1	5	60,000	43.0	70	21-3/4 X 30 X 68
HP060HSRNXET1XX1	5	60,000	43.0	70	21-3/4 X 30 X 68
HP060VTLCDDET1XX1	5	60,000	43.0	70	51-1/4 X 26 X 32-1/4
HP060VTLXCXET1XX1	5	60,000	43.0	70	51-1/4 X 26 X 32-1/4
HP060VTLNDET1XX1	5	60,000	43.0	70	51-1/4 X 26 X 32-1/4
HP060VTLNXET1XX1	5	60,000	43.0	70	51-1/4 X 26 X 32-1/4
HP060VTRCDET1XX1	5	60,000	43.0	70	51-1/4 X 26 X 32-1/4
HP060VTRCXET1XX1	5	60,000	43.0	70	51-1/4 X 26 X 32-1/4
HP060VTRNDET1XX1	5	60,000	43.0	70	51-1/4 X 26 X 32-1/4
HP060VTRNXET1XX1	5	60,000	43.0	70	51-1/4 X 26 X 32-1/4
HP072CBLCDDET1XX1	6	72,000	46.2	70	58-1/4 X 26 X 33-1/4
HP072CBLXCXET1XX1	6	72,000	46.2	70	58-1/4 X 26 X 33-1/4
HP072CBLNDET1XX1	6	72,000	46.2	70	58-1/4 X 26 X 33-1/4
HP072CBLNXET1XX1	6	72,000	46.2	70	58-1/4 X 26 X 33-1/4
HP072CBRCDET1XX1	6	72,000	46.2	70	58-1/4 X 26 X 33-1/4
HP072CBRCXET1XX1	6	72,000	46.2	70	58-1/4 X 26 X 33-1/4
HP072CBRNDDET1XX1	6	72,000	46.2	70	58-1/4 X 26 X 33-1/4
HP072CBRNXET1XX1	6	72,000	46.2	70	58-1/4 X 26 X 33-1/4
HP072HELCDDET1XX1	6	72,000	46.2	70	21-3/4 X 30 X 78
HP072HELXCXET1XX1	6	72,000	46.2	70	21-3/4 X 30 X 78
HP072HELNDET1XX1	6	72,000	46.2	70	21-3/4 X 30 X 78
HP072HELNXET1XX1	6	72,000	46.2	70	21-3/4 X 30 X 78
HP072HERCDDET1XX1	6	72,000	46.2	70	21-3/4 X 30 X 78
HP072HERCXET1XX1	6	72,000	46.2	70	21-3/4 X 30 X 78
HP072HERNDET1XX1	6	72,000	46.2	70	21-3/4 X 30 X 78
HP072HERNXET1XX1	6	72,000	46.2	70	21-3/4 X 30 X 78
HP072HSLCDDET1XX1	6	72,000	46.2	70	21-3/4 X 30 X 78
HP072HSLXCXET1XX1	6	72,000	46.2	70	21-3/4 X 30 X 78
HP072HSLNDET1XX1	6	72,000	46.2	70	21-3/4 X 30 X 78
HP072HSLNXET1XX1	6	72,000	46.2	70	21-3/4 X 30 X 78
HP072HSRCDET1XX1	6	72,000	46.2	70	21-3/4 X 30 X 78
HP072HSRCXET1XX1	6	72,000	46.2	70	21-3/4 X 30 X 78
HP072HSRNDDET1XX1	6	72,000	46.2	70	21-3/4 X 30 X 78
HP072HSRNXET1XX1	6	72,000	46.2	70	21-3/4 X 30 X 78
HP072VTLCDDET1XX1	6	72,000	46.2	70	58-1/4 X 26 X 33-1/4
HP072VTLXCXET1XX1	6	72,000	46.2	70	58-1/4 X 26 X 33-1/4
HP072VTLNDET1XX1	6	72,000	46.2	70	58-1/4 X 26 X 33-1/4
HP072VTLNXET1XX1	6	72,000	46.2	70	58-1/4 X 26 X 33-1/4
HP072VTRCDET1XX1	6	72,000	46.2	70	58-1/4 X 26 X 33-1/4
HP072VTRCXET1XX1	6	72,000	46.2	70	58-1/4 X 26 X 33-1/4
HP072VTRNDET1XX1	6	72,000	46.2	70	58-1/4 X 26 X 33-1/4
HP072VTRNXET1XX1	6	72,000	46.2	70	58-1/4 X 26 X 33-1/4

# HB

## R410-A Geothermal Package Heat Pump 1.5 – 5 Ton



### Easier to Sell

- 3.7 - 4.3 COP, 18.5 - 21.7 EER (Closed Loop)
- 4.3 - 5.2 COP, 22.7 - 28.1 EER (Open Loop)
- 2" filter, MERV 8
- Unit available in vertical, upflow and horizontal
- Fully insulated cabinet with closed cell foam
- Optional supplemental domestic water heating

### Tougher

- Single-stage scroll compressor (rotary size 018)
- Multi-speed constant torque blower motor
- Tin-plated copper tubing in air coil



Qualifying models only.

### Easier to Install and Service

- Compatible with many three-stage heat, single-stage cooling programmable thermostats
- Microprocessor control

### Warranty\*

- Five-year parts and labor limited warranty (including compressor)
  - With timely registration, an additional five-year parts limited warranty (including compressor)

\* For residential applications only.

See warranty certificate for complete details and restrictions, including warranty coverage for other applications.

### Unit Performance Data

Model Number	Size (tons)	Nominal Btu/hr	Min. Circuit Ampacity	Max. Fuse or Breaker	Dimensions H x W x D (sq) in.
HB018HELXCXC1XX1	1.5	18,000	12.1	15	19-3/4 X 22-1/4 X 45-1/4
HB018HELNXCC1XX1	1.5	18,000	12.1	15	19-3/4 X 22-1/4 X 45-1/4
HB018HERXCXC1XX1	1.5	18,000	12.1	15	19-3/4 X 22-1/4 X 45-1/4
HB018HERNXCC1XX1	1.5	18,000	12.1	15	19-3/4 X 22-1/4 X 45-1/4
HB018HSLXCXC1XX1	1.5	18,000	12.1	15	19-3/4 X 22-1/4 X 45-1/4
HB018HSLNXCC1XX1	1.5	18,000	12.1	15	19-3/4 X 22-1/4 X 45-1/4
HB018HSRCXC1XX1	1.5	18,000	12.1	15	19-3/4 X 22-1/4 X 45-1/4
HB018HSRNXC1XX1	1.5	18,000	12.1	15	19-3/4 X 22-1/4 X 45-1/4
HB018VTLXCXC1XX1	1.5	18,000	12.1	15	39-1/4 X 21-3/4 X 21-3/4
HB018VTLNXCC1XX1	1.5	18,000	12.1	15	39-1/4 X 21-3/4 X 21-3/4
HB018VTRXCXC1XX1	1.5	18,000	12.1	15	39-1/4 X 21-3/4 X 21-3/4
HB018VTRNXCC1XX1	1.5	18,000	12.1	15	39-1/4 X 21-3/4 X 21-3/4
HB024HELCDCC1XX1	2	24,000	19.7	30	22 X 26-1/4 X 54-3/4
HB024HELXCXC1XX1	2	24,000	19.7	30	22 X 26-1/4 X 54-3/4
HB024HELNDCC1XX1	2	24,000	19.7	30	22 X 26-1/4 X 54-3/4
HB024HELNXCC1XX1	2	24,000	19.7	30	22 X 26-1/4 X 54-3/4
HB024HERCDCC1XX1	2	24,000	19.7	30	22 X 26-1/4 X 54-3/4
HB024HERXCXC1XX1	2	24,000	19.7	30	22 X 26-1/4 X 54-3/4
HB024HERNDCC1XX1	2	24,000	19.7	30	22 X 26-1/4 X 54-3/4
HB024HERNXCC1XX1	2	24,000	19.7	30	22 X 26-1/4 X 54-3/4
HB024HSLCDCC1XX1	2	24,000	19.7	30	22 X 26-1/4 X 54-3/4
HB024HSLXCXC1XX1	2	24,000	19.7	30	22 X 26-1/4 X 54-3/4
HB024HSLNDCC1XX1	2	24,000	19.7	30	22 X 26-1/4 X 54-3/4
HB024HSLNXCC1XX1	2	24,000	19.7	30	22 X 26-1/4 X 54-3/4
HB024HSRCDCC1XX1	2	24,000	19.7	30	22 X 26-1/4 X 54-3/4



Unit Performance Data

Model Number	Size (tons)	Nominal Btu/hr	Min. Circuit Ampacity	Max. Fuse or Breaker	Dimensions H x W x D (sq) in.
HB024HSRCXCC1XX1	2	24,000	19.7	30	22 X 26-1/4 X 54-3/4
HB024HSRNDCC1XX1	2	24,000	19.7	30	22 X 26-1/4 X 54-3/4
HB024HSRNXC1XX1	2	24,000	19.7	30	22 X 26-1/4 X 54-3/4
HB024VTLCDCC1XX1	2	24,000	19.7	30	47-1/4 X 21-3/4 X 26-1/4
HB024VTLCXCC1XX1	2	24,000	19.7	30	47-1/4 X 21-3/4 X 26-1/4
HB024VTLNDCC1XX1	2	24,000	19.7	30	47-1/4 X 21-3/4 X 26-1/4
HB024VTLNXCC1XX1	2	24,000	19.7	30	47-1/4 X 21-3/4 X 26-1/4
HB024VTRCDCC1XX1	2	24,000	19.7	30	47-1/4 X 21-3/4 X 26-1/4
HB024VTRCXCC1XX1	2	24,000	19.7	30	47-1/4 X 21-3/4 X 26-1/4
HB024VTRNDCC1XX1	2	24,000	19.7	30	47-1/4 X 21-3/4 X 26-1/4
HB024VTRNXCC1XX1	2	24,000	19.7	30	47-1/4 X 21-3/4 X 26-1/4
HB030HELCDC1XX1	2.5	30,000	20.1	30	22 X 30-1/4 X 68-1/4
HB030HELCXC1XX1	2.5	30,000	20.1	30	22 X 30-1/4 X 68-1/4
HB030HELNDCC1XX1	2.5	30,000	20.1	30	22 X 30-1/4 X 68-1/4
HB030HELNXCC1XX1	2.5	30,000	20.1	30	22 X 30-1/4 X 68-1/4
HB030HERCDCC1XX1	2.5	30,000	20.1	30	22 X 30-1/4 X 68-1/4
HB030HERCXCC1XX1	2.5	30,000	20.1	30	22 X 30-1/4 X 68-1/4
HB030HERNDCC1XX1	2.5	30,000	20.1	30	22 X 30-1/4 X 68-1/4
HB030HERNXCC1XX1	2.5	30,000	20.1	30	22 X 30-1/4 X 68-1/4
HB030HSLDC1XX1	2.5	30,000	20.1	30	22 X 30-1/4 X 68-1/4
HB030HSLXC1XX1	2.5	30,000	20.1	30	22 X 30-1/4 X 68-1/4
HB030HSLNDCC1XX1	2.5	30,000	20.1	30	22 X 30-1/4 X 68-1/4
HB030HSLNDCC1XX1	2.5	30,000	20.1	30	22 X 30-1/4 X 68-1/4
HB030HSLNXCC1XX1	2.5	30,000	20.1	30	22 X 30-1/4 X 68-1/4
HB030HSRCDCC1XX1	2.5	30,000	20.1	30	22 X 30-1/4 X 68-1/4
HB030HSRCXC1XX1	2.5	30,000	20.1	30	22 X 30-1/4 X 68-1/4
HB030HSRNDCC1XX1	2.5	30,000	20.1	30	22 X 30-1/4 X 68-1/4
HB030HSRNXC1XX1	2.5	30,000	20.1	30	22 X 30-1/4 X 68-1/4
HB030VTLCDCC1XX1	2.5	30,000	20.1	30	47-1/4 X 24-1/4 X 33-1/2
HB030VTLCXC1XX1	2.5	30,000	20.1	30	47-1/4 X 24-1/4 X 33-1/2
HB030VTLNDCC1XX1	2.5	30,000	20.1	30	47-1/4 X 24-1/4 X 33-1/2
HB030VTLNXCC1XX1	2.5	30,000	20.1	30	47-1/4 X 24-1/4 X 33-1/2
HB030VTRCDCC1XX1	2.5	30,000	20.1	30	47-1/4 X 24-1/4 X 33-1/2
HB030VTRCXCC1XX1	2.5	30,000	20.1	30	47-1/4 X 24-1/4 X 33-1/2
HB030VTRNDCC1XX1	2.5	30,000	20.1	30	47-1/4 X 24-1/4 X 33-1/2
HB030VTRNXCC1XX1	2.5	30,000	20.1	30	47-1/4 X 24-1/4 X 33-1/2
HB036HELCXC1XX1	3	36,000	26.0	40	22 X 30-1/4 X 68-1/4
HB036HELCXC1XX1	3	36,000	26.0	40	22 X 30-1/4 X 68-1/4
HB036HELNDCC1XX1	3	36,000	26.0	40	22 X 30-1/4 X 68-1/4
HB036HELNXCC1XX1	3	36,000	26.0	40	22 X 30-1/4 X 68-1/4
HB036HERCDCC1XX1	3	36,000	26.0	40	22 X 30-1/4 X 68-1/4
HB036HERCXCC1XX1	3	36,000	26.0	40	22 X 30-1/4 X 68-1/4
HB036HERNDCC1XX1	3	36,000	26.0	40	22 X 30-1/4 X 68-1/4
HB036HERNXCC1XX1	3	36,000	26.0	40	22 X 30-1/4 X 68-1/4

# HB Unit Performance Data

Model Number	Size (tons)	Nominal Btu/hr	Min. Circuit Ampacity	Max. Fuse or Breaker	Dimensions H x W x D (sq) in.
HB036HSLCDDCC1XX1	3	36,000	26.0	40	22 X 30-1/4 X 68-1/4
HB036HSLCXCC1XX1	3	36,000	26.0	40	22 X 30-1/4 X 68-1/4
HB036HSLNDCC1XX1	3	36,000	26.0	40	22 X 30-1/4 X 68-1/4
HB036HSLNXCC1XX1	3	36,000	26.0	40	22 X 30-1/4 X 68-1/4
HB036HSRCDCC1XX1	3	36,000	26.0	40	22 X 30-1/4 X 68-1/4
HB036HSRCXCC1XX1	3	36,000	26.0	40	22 X 30-1/4 X 68-1/4
HB036HSRNDCC1XX1	3	36,000	26.0	40	22 X 30-1/4 X 68-1/4
HB036HSRNXCC1XX1	3	36,000	26.0	40	22 X 30-1/4 X 68-1/4
HB036VTLCDCC1XX1	3	36,000	26.0	40	47-1/4 X 24-1/4 X 33-1/2
HB036VTLCXCC1XX1	3	36,000	26.0	40	47-1/4 X 24-1/4 X 33-1/2
HB036VTLNDCC1XX1	3	36,000	26.0	40	47-1/4 X 24-1/4 X 33-1/2
HB036VTLNXCC1XX1	3	36,000	26.0	40	47-1/4 X 24-1/4 X 33-1/2
HB036VTRCDCC1XX1	3	36,000	26.0	40	47-1/4 X 24-1/4 X 33-1/2
HB036VTRCXCC1XX1	3	36,000	26.0	40	47-1/4 X 24-1/4 X 33-1/2
HB036VTRNDCC1XX1	3	36,000	26.0	40	47-1/4 X 24-1/4 X 33-1/2
HB036VTRNXCC1XX1	3	36,000	26.0	40	47-1/4 X 24-1/4 X 33-1/2
HB042HELCDCC1XX1	3.5	42,000	26.9	40	22 X 30-1/4 X 79
HB042HELXCXCC1XX1	3.5	42,000	26.9	40	22 X 30-1/4 X 79
HB042HELNDCC1XX1	3.5	42,000	26.9	40	22 X 30-1/4 X 79
HB042HELNXCC1XX1	3.5	42,000	26.9	40	22 X 30-1/4 X 79
HB042HERCDCC1XX1	3.5	42,000	26.9	40	22 X 30-1/4 X 79
HB042HERCXCC1XX1	3.5	42,000	26.9	40	22 X 30-1/4 X 79
HB042HERNDCC1XX1	3.5	42,000	26.9	40	22 X 30-1/4 X 79
HB042HERNXCC1XX1	3.5	42,000	26.9	40	22 X 30-1/4 X 79
HB042HSLCDCC1XX1	3.5	42,000	26.9	40	22 X 30-1/4 X 79
HB042HSLCXCC1XX1	3.5	42,000	26.9	40	22 X 30-1/4 X 79
HB042HSLNDCC1XX1	3.5	42,000	26.9	40	22 X 30-1/4 X 79
HB042HSLNXCC1XX1	3.5	42,000	26.9	40	22 X 30-1/4 X 79
HB042HSRCDCC1XX1	3.5	42,000	26.9	40	22 X 30-1/4 X 79
HB042HSRCXCC1XX1	3.5	42,000	26.9	40	22 X 30-1/4 X 79
HB042HSRNDCC1XX1	3.5	42,000	26.9	40	22 X 30-1/4 X 79
HB042HSRNXCC1XX1	3.5	42,000	26.9	40	22 X 30-1/4 X 79
HB042VTLCDCC1XX1	3.5	42,000	26.9	40	58-1/4 X 26-1/4 X 33-1/2
HB042VTLCXCC1XX1	3.5	42,000	26.9	40	58-1/4 X 26-1/4 X 33-1/2
HB042VTLNDCC1XX1	3.5	42,000	26.9	40	58-1/4 X 26-1/4 X 33-1/2
HB042VTLNXCC1XX1	3.5	42,000	26.9	40	58-1/4 X 26-1/4 X 33-1/2
HB042VTRCDCC1XX1	3.5	42,000	26.9	40	58-1/4 X 26-1/4 X 33-1/2
HB042VTRCXCC1XX1	3.5	42,000	26.9	40	58-1/4 X 26-1/4 X 33-1/2
HB042VTRNDCC1XX1	3.5	42,000	26.9	40	58-1/4 X 26-1/4 X 33-1/2
HB042VTRNXCC1XX1	3.5	42,000	26.9	40	58-1/4 X 26-1/4 X 33-1/2
HB048HELCDCC1XX1	4	48,000	30.9	50	22 X 32-1/4 X 79
HB048HELXCXCC1XX1	4	48,000	30.9	50	22 X 32-1/4 X 79
HB048HELNDCC1XX1	4	48,000	30.9	50	22 X 32-1/4 X 79
HB048HELNXCC1XX1	4	48,000	30.9	50	22 X 32-1/4 X 79

Model Number	Size (tons)	Nominal Btu/hr	Min. Circuit Ampacity	Max. Fuse or Breaker	Dimensions H x W x D (sq) in.
HB024CBLCDDET1XX1	4	48,000	30.9	50	22 X 32-1/4 X 79
HB048HERCXCC1XX1	4	48,000	30.9	50	22 X 32-1/4 X 79
HB048HERNDCC1XX1	4	48,000	30.9	50	22 X 32-1/4 X 79
HB048HERNXCC1XX1	4	48,000	30.9	50	22 X 32-1/4 X 79
HB048HSLCDCC1XX1	4	48,000	30.9	50	22 X 32-1/4 X 79
HB048HSLCXCC1XX1	4	48,000	30.9	50	22 X 32-1/4 X 79
HB048HSLNDCC1XX1	4	48,000	30.9	50	22 X 32-1/4 X 79
HB048HSLNXCC1XX1	4	48,000	30.9	50	22 X 32-1/4 X 79
HB048HSRCDCC1XX1	4	48,000	30.9	50	22 X 32-1/4 X 79
HB048HSRCXCC1XX1	4	48,000	30.9	50	22 X 32-1/4 X 79
HB048HSRNDCC1XX1	4	48,000	30.9	50	22 X 32-1/4 X 79
HB048HSRNXCC1XX1	4	48,000	30.9	50	22 X 32-1/4 X 79
HB048VTLCDCC1XX1	4	48,000	30.9	50	58-1/4 X 26-1/4 X 33-1/2
HB048VTLCXCC1XX1	4	48,000	30.9	50	58-1/4 X 26-1/4 X 33-1/2
HB048VTLNDCC1XX1	4	48,000	30.9	50	58-1/4 X 26-1/4 X 33-1/2
HB048VTLNXCC1XX1	4	48,000	30.9	50	58-1/4 X 26-1/4 X 33-1/2
HB048VTRCDCC1XX1	4	48,000	30.9	50	58-1/4 X 26-1/4 X 33-1/2
HB048VTRCXCC1XX1	4	48,000	30.9	50	58-1/4 X 26-1/4 X 33-1/2
HB048VTRNDCC1XX1	4	48,000	30.9	50	58-1/4 X 26-1/4 X 33-1/2
HB048VTRNXCC1XX1	4	48,000	30.9	50	58-1/4 X 26-1/4 X 33-1/2
HB060HELCDCC1XX1	5	60,000	38.9	60	22 X 30-1/4 X 89-1/4
HB060HELCXCC1XX1	5	60,000	38.9	60	22 X 30-1/4 X 89-1/4
HB060HELNDCC1XX1	5	60,000	38.9	60	22 X 30-1/4 X 89-1/4
HB060HELNXCC1XX1	5	60,000	38.9	60	22 X 30-1/4 X 89-1/4
HB060HERCDCC1XX1	5	60,000	38.9	60	22 X 30-1/4 X 89-1/4
HB060HERCXCC1XX1	5	60,000	38.9	60	22 X 30-1/4 X 89-1/4
HB060HERNDCC1XX1	5	60,000	38.9	60	22 X 30-1/4 X 89-1/4
HB060HERNXCC1XX1	5	60,000	38.9	60	22 X 30-1/4 X 89-1/4
HB060HSLCDCC1XX1	5	60,000	38.9	60	22 X 30-1/4 X 89-1/4
HB060HSLCXCC1XX1	5	60,000	38.9	60	22 X 30-1/4 X 89-1/4
HB060HSLNDCC1XX1	5	60,000	38.9	60	22 X 30-1/4 X 89-1/4
HB060HSLNXCC1XX1	5	60,000	38.9	60	22 X 30-1/4 X 89-1/4
HB060HSRCDCC1XX1	5	60,000	38.9	60	22 X 30-1/4 X 89-1/4
HB060HSRCXCC1XX1	5	60,000	38.9	60	22 X 30-1/4 X 89-1/4
HB060HSRNDCC1XX1	5	60,000	38.9	60	22 X 30-1/4 X 89-1/4
HB060HSRNXCC1XX1	5	60,000	38.9	60	22 X 30-1/4 X 89-1/4
HB060VTLCDCC1XX1	5	60,000	38.9	60	66-1/4 X 26-1/4 X 33-1/2
HB060VTLCXCC1XX1	5	60,000	38.9	60	66-1/4 X 26-1/4 X 33-1/2
HB060VTLNDCC1XX1	5	60,000	38.9	60	66-1/4 X 26-1/4 X 33-1/2
HB060VTLNXCC1XX1	5	60,000	38.9	60	66-1/4 X 26-1/4 X 33-1/2
HB060VTRCDCC1XX1	5	60,000	38.9	60	66-1/4 X 26-1/4 X 33-1/2
HB060VTRCXCC1XX1	5	60,000	38.9	60	66-1/4 X 26-1/4 X 33-1/2
HB060VTRNDCC1XX1	5	60,000	38.9	60	66-1/4 X 26-1/4 X 33-1/2
HB060VTRNXCC1XX1	5	60,000	38.9	60	66-1/4 X 26-1/4 X 33-1/2

# HS

## R410-A Geothermal Split Heat Pump



2 – 5 Ton

### Easier to Sell

- 3.4 - 4.5 COP, 15.4 - 26.4 EER (Closed Loop)
- 3.9 - 5.1 COP, 19.2 - 30.5 EER (Open Loop)
- Compressor blanket
- Fully insulated cabinet with closed cell foam
- Optional supplemental domestic water heating

### Tougher

- Two-stage scroll compressor
- Used with variable-speed fan coil or furnace with evaporator coil



Qualifying models only.

### Easier to Install and Service

- Unit compatible with ICP evaporator coils
- Compatible with FVM4X fan coils
- Microprocessor control
- Compatible with many three-stage heat, two-stage cooling programmable thermostats

### Warranty\*

- Five-year No Hassle Replacement™ limited warranty
- Five-year labor limited warranty
  - With timely registration, an additional five-year labor limited warranty
- 10-year labor limited warranty (including compressor)

\* For residential applications only (owner occupied for No Hassle Replacement warranty). See warranty certificate for complete details and restrictions, including warranty coverage for other applications.

### Unit Performance Data

Model Number	Size (tons)	Nominal Btu/hr	Min. Circuit Ampacity	Max. Fuse or Breaker	Dimensions H x W x D (sq) in.	Operating (Shipping) Wt lbs.
HS024SXXCDXX1XX1	2	24,000	14.6	25	21-1/2 X 24 X 27-3/8	189 (172)
HS024SXXCXXX1XX1	2	24,000	14.6	25	21-1/2 X 24 X 27-3/8	189 (172)
HS024SXXNDXX1XX1	2	24,000	14.6	25	21-1/2 X 24 X 27-3/8	189 (172)
HS024SXXNXXX1XX1	3	36,000	19.1	30	21-1/2 X 24 X 27-3/8	189 (172)
HS036SXXCDXX1XX1	3	36,000	19.1	30	21-1/2 X 24 X 27-3/8	189 (172)
HS036SXXCXXX1XX1	3	36,000	19.1	30	21-1/2 X 24 X 27-3/8	189 (172)
HS036SXXNDXX1XX1	3	36,000	19.1	30	21-1/2 X 24 X 27-3/8	189 (172)
HS036SXXNXXX1XX1	3	36,000	19.1	30	21-1/2 X 24 X 27-3/8	189 (172)
HS048SXXCDXX1XX1	4	48,000	26.5	45	21-1/2 X 24 X 27-3/8	189 (172)
HS048SXXCXXX1XX1	4	48,000	26.5	45	21-1/2 X 24 X 27-3/8	189 (172)
HS048SXXNDXX1XX1	4	48,000	26.5	45	21-1/2 X 24 X 27-3/8	189 (172)
HS048SXXNXXX1XX1	4	48,000	26.5	45	21-1/2 X 24 X 27-3/8	189 (172)
HS060SXXCDXX1XX1	5	60,000	33.9	60	23-1/4 X 27 X 33-3/8	261 (237)
HS060SXXCXXX1XX1	5	60,000	33.9	60	23-1/4 X 27 X 33-3/8	261 (237)
HS060SXXNDXX1XX1	5	60,000	33.9	60	23-1/4 X 27 X 33-3/8	261 (237)
HS060SXXNXXX1XX1	5	60,000	33.9	60	23-1/4 X 27 X 33-3/8	261 (237)



# HW

## R410-A Water-to-Water Heat Pump

2 – 6 Ton

### Easier to Sell

- 3.0 - 3.2 COP, 14.6 - 22.1 EER (Closed Loop)
- 3.4 - 3.8 COP, 18.8 - 25.7 EER (Open Loop)
- Fully insulated cabinet with fiberglass
- Compressor blanket
- Optional supplemental domestic water heating

### Tougher

- Two-stage scroll compressor



Qualifying models only.

### Easier to Install and Service

- Unit designed for variety of hydronic applications
- Microprocessor control

### Warranty\*

- Five-year No Hassle Replacement™ limited warranty
- Five-year labor limited warranty
  - With timely registration, an additional five-year labor limited warranty
- 10-year parts limited warranty (including compressor)

\* For residential applications only (owner occupied for No Hassle Replacement warranty).  
See warranty certificate for complete details and restrictions, including warranty coverage for other applications.

### Unit Performance Data

Model Number	Size (tons)	Nominal Btu/hr	Min. Circuit Ampacity	Max. Fuse or Breaker	Dimensions H x W x D in.	Ship/Operating Weight lbs.
HW024WXXDDXX1XX1	2	24,000	14.6	25	24-1/8 x 32-1/2 x 24	250 (270)
HW024WXXDXX1XX1	2	24,000	14.6	25	24-1/8 x 32-1/2 x 24	250 (270)
HW024WXXEDXX1XX1	2	24,000	14.6	25	24-1/8 x 32-1/2 x 24	250 (270)
HW024WXXEXXX11XX1	2	24,000	14.6	25	24-1/8 x 32-1/2 x 24	250 (270)
HW024WXXFDXX1XX1	2	24,000	14.6	25	24-1/8 x 32-1/2 x 24	250 (270)
HW024WXXFXX1XX1	2	24,000	14.6	25	24-1/8 x 32-1/2 x 24	250 (270)
HW024WXXGDXX1XX1	2	24,000	14.6	25	24-1/8 x 32-1/2 x 24	250 (270)
HW024WXXGXX1XX1	2	24,000	14.6	25	24-1/8 x 32-1/2 x 24	250 (270)
HW036WXXDDXX1XX1	3	36,000	19.1	30	24-1/8 x 32-1/2 x 24	270 (290)
HW036WXXDXX1XX1	3	36,000	19.1	30	24-1/8 x 32-1/2 x 24	270 (290)
HW036WXXEDXX1XX1	3	36,000	19.1	30	24-1/8 x 32-1/2 x 24	270 (290)
HW036WXXEXXX1XX1	3	36,000	19.1	30	24-1/8 x 32-1/2 x 24	270 (290)
HW036WXXFDXX1XX1	3	36,000	19.1	30	24-1/8 x 32-1/2 x 24	270 (290)
HW036WXXFXX1XX1	3	36,000	19.1	30	24-1/8 x 32-1/2 x 24	270 (290)
HW036WXXGDXX1XX1	3	36,000	19.1	30	24-1/8 x 32-1/2 x 24	270 (290)
HW036WXXGXX1XX1	3	36,000	19.1	30	24-1/8 x 32-1/2 x 24	270 (290)

**NOTE: These Models Currently Not Available**

# HW con't

## R410-A Geothermal Split Heat Pump

### Unit Performance Data

Model Number	Size (tons)	Nominal Btu/hr	Min. Circuit Ampacity	Max. Fuse or Breaker	Dimensions H x W x D in.	Ship/Operating Weight lbs.
HW048WXXDDXX1XX1	4	48,000	26.5	45	24-1/8 x 32-1/2 x 24	252 (270)
HW048WXXDXXX1XX1	4	48,000	26.5	45	24-1/8 x 32-1/2 x 24	252 (270)
HW048WXXEDXX1XX1	4	48,000	26.5	45	24-1/8 x 32-1/2 x 24	252 (270)
HW048WXXEXXX1XX1	4	48,000	26.5	45	24-1/8 x 32-1/2 x 24	252 (270)
HW048WXXFDXX1XX1	4	48,000	26.5	45	24-1/8 x 32-1/2 x 24	252 (270)
HW048WXXFXXX1XX1	4	48,000	26.5	45	24-1/8 x 32-1/2 x 24	252 (270)
HW048WXXGDXX1XX1	4	48,000	26.5	45	24-1/8 x 32-1/2 x 24	252 (270)
HW048WXXGXXX1XX1	4	48,000	26.5	45	24-1/8 x 32-1/2 x 24	252 (270)
HW060WXXDDXX1XX1	5	60,000	33.9	60	24-1/8 x 32-1/2 x 24	340 (360)
HW060WXXDXXX1XX1	5	60,000	33.9	60	24-1/8 x 32-1/2 x 24	340 (360)
HW060WXXEDXX1XX1	5	60,000	33.9	60	24-1/8 x 32-1/2 x 24	340 (360)
HW060WXXEXXX1XX1	5	60,000	33.9	60	24-1/8 x 32-1/2 x 24	340 (360)
HW060WXXFDXX1XX1	5	60,000	33.9	60	24-1/8 x 32-1/2 x 24	340 (360)
HW060WXXFXXX1XX1	5	60,000	33.9	60	24-1/8 x 32-1/2 x 24	340 (360)
HW060WXXGDXX1XX1	5	60,000	33.9	60	24-1/8 x 32-1/2 x 24	340 (360)
HW060WXXGXXX1XX1	5	60,000	33.9	60	24-1/8 x 32-1/2 x 24	340 (360)
HW072WXXDDXX1XX1	6	72,000	37.1	60	24-1/8 x 32-1/2 x 24	340 (360)
HW072WXXDXXX1XX1	6	72,000	37.1	60	24-1/8 x 32-1/2 x 24	360 (380)
HW072WXXEDXX1XX1	6	72,000	37.1	60	24-1/8 x 32-1/2 x 24	360 (380)
HW072WXXEXXX1XX1	6	72,000	37.1	60	24-1/8 x 32-1/2 x 24	360 (380)
HW072WXXFDXX1XX1	6	72,000	37.1	60	24-1/8 x 32-1/2 x 24	360 (380)
HW072WXXFXXX1XX1	6	72,000	37.1	60	24-1/8 x 32-1/2 x 24	360 (380)
HW072WXXGDXX1XX1	6	72,000	37.1	60	24-1/8 x 32-1/2 x 24	360 (380)
HW072WXXGXXX1XX1	6	72,000	37.1	60	24-1/8 x 32-1/2 x 24	360 (380)

### Residential Flow Centers

Flo-Link Series (Double O-Ring) Pressurized Flow Centers	
Part Number	Description
<b>Flo-Link Foamed Cabinet (Double O-Ring Connections – Brass Valves)</b>	
FCP11BD	FL1-99 USPS26-99, Three-Speed, 230V, Grundfos
FCP12BD	FL1-116 UP26-116, Single-Speed, 230V, Grundfos
FCP13BD	FLV1, UPS32-140 (Variable-Speed), 230V, Grundfos
FCP21BD	FL2-99 UPS26-99, Three-Speed, 230V, Grundfos, Quantity: 2
FCP22BD	FL2-116 UP26-116, Single-Speed, 230V, Grundfos, Quantity: 2
FCP24BD	FLV2, one UPS32-140 (Variable-Speed) and one UPS26-99 (Three-Speed), 230V, Grundfos*

\*Variable-speed flow centers require a controller package. See Accessory section of Geothermal System Components Catalog.

**Note:** Each unit contains: Mounting hardware and one set of Flo-Link by 1-1/4 in. fusion fittings (loop side).

Part Number	Description
<b>Flo-Link Foamed Cabinet (Double O-Ring Connections – Composite Valves)</b>	
FCP11CD	FL1-99 USPS26-99, Three-Speed, 230V, Grundfos
FCP21CD	FL2-99 UPS26-99, Three-Speed, 230V, Grundfos, Quantity: 2

**Note:** Each unit contains: Mounting hardware and one set of Flo-Link by 1-1/4 in. fusion fittings (loop side).

Panel Mount Variable-Speed Flow Centers			
Part Number	Description		
	Variable-Speed Pre-Wired Packages (Panel Mounted)		
	Flow Center	Control	Connections
FCM13BDT	Single Pump, Brass Valves	Temperature Difference	Hose Kit / PE Fusion*
FCM13BDF	Single Pump, Brass Valves	Flow & Temperature Control	Hose Kit / PE Fusion*
FCM24BDT	Two Pump, Brass Valves	Temperature Difference	Hose Kit / PE Fusion*
FCM24BDF	Two Pump, Brass Valves	Flow & Temperature Control	Hose Kit / PE Fusion*

\*Kit includes all of the fittings necessary for connecting to the ground loop (1-1/4" PE fusion) and to the heat pump (1" MPT).

GPM Series (FPT) Pressurized Flow Centers	
Part Number	Description
<b>GPM-1 with Foamed Cabinet (FPT Connections)</b>	
FCP11BF	GPM-1 UPS26-99, Three-Speed, 230V Grundfos
FCP12BF	GPM-1 UP26-116, Single-Speed, 230V Grundfos
<b>GPM-2 with Foamed Cabinet (FPT Connections)</b>	
FCP21BF	GPM-2 UPS26-99, Three-Speed, 230V Grundfos, Quantity: 2
FCP22BF	GPM-2 UP26-116, Single-Speed, 230V Grundfos, Quantity: 2
<b>GPM-3 with Foamed Cabinet (FPT Connections)</b>	
FCP31BF	GPM-3 UPS26-99, Three-Speed, 230V Grundfos, Quantity: 3
FCP32BF	GPM-2 UP26-116, Single-Speed, 230V Grundfos, Quantity: 3
<b>GPM-4 with Foamed Cabinet (FPT Connections)</b>	
FCP41BF	GPM-4 UPS26-99, Three-Speed, 230V Grundfos, Quantity: 4
FCP42BF	GPM-2 UP26-116, Single-Speed, 230V Grundfos, Quantity: 4

**Note:** Each unit contains: Mounting hardware.

# Accessories

## Geothermal

NP Series Non-Pressurized Flow Center	
Part Number	Description
<b>NP<sup>1</sup> with Foamed Cabinet (Flo-Link Double O-Ring Connections)</b>	
FCN11CD	NP <sup>1</sup> UPS26-99, Three-Speed, 230V, Grundfos
FCN12CD	NP <sup>1</sup> UP26-116, Single-Speed, 230V, Grundfos
<b>NP<sup>2</sup> with Foamed Cabinet (Flo-Link Double O-Ring Connections)</b>	
FCN21CD	NP <sup>2</sup> UPS26-99, Three-Speed, 230V, Grundfos, Quantity: 2
FCN22CD	NP <sup>2</sup> UP26-116, Single-Speed, 230V, Grundfos, Quantity: 2
<b>NP<sup>V</sup> and NP<sup>V2</sup> with Foamed Cabinet (Flo-Link Double O-Ring Connections)</b>	
FCN13CD	NP <sup>V</sup> Magna GEO (Variable-Speed), 230V, Grundfos*
FCN24CD	NP <sup>V2</sup> One Magna GEO (Variable-Speed) and One UPS26-99 (Constant Speed), 230V, Grundfos*

\*Variable-speed flow centers require a controller package.

**Note:** Requires Flo-Link adapter sets for all connections or connector kit.

Hose Kits	
Part Number	Description
<b>1-inch Hose Kit (MPT @ Flow Center and Heat Pump)</b>	
HK4MM	<p><b>Hose Kit Contents:</b></p> <ul style="list-style-type: none"> <li>Quantity 1: 12 ft. 1-inch ID Black Hose</li> <li>Quantity 2: Insulating Boot</li> <li>Quantity 2: Insulating Boot Caps</li> <li>Quantity 2: PT Plug, 1/4" MPT</li> <li>Quantity 2: Fitting, 1" MPT x 1" Hose Barb (flow center connection)</li> <li>Quantity 2: Elbow, 1" MPT x 1" Hose Barb with PT Port (heat pump connection)</li> <li>Quantity 8: Hose Clamps</li> </ul>
<b>1-inch Hose Kit (Flo-Link Double O-Ring @ Flow Center; MPT™ HP)</b>	
HK4DM	<p><b>Hose Kit Contents:</b></p> <ul style="list-style-type: none"> <li>Quantity 1: 12 ft. 1-inch ID Black Hose</li> <li>Quantity 2: Insulating Boot</li> <li>Quantity 2: Insulating Boot Caps</li> <li>Quantity 2: PT Plug, 1/4" MPT</li> <li>Quantity 2: Fitting, Flo-Link x 1" Hose Barb (flow center connection)</li> <li>Quantity 2: Elbow, 1" MPT x 1" Hose Barb with PT Port (heat pump connection)</li> <li>Quantity 8: Hose Clamps</li> </ul>



Fittings	
Part Number	Description
<b>PE and PVC Adapters</b>	
FIS4D5U	Flo-Link x 1-1/4" PE Fusion
FIS4D4U	Flo-Link x 1" PE Fusion
FIS4D5P	Flo-Link x 1-1/4" PVC Glue
<b>Brass Adapters - Hose Barb</b>	
FIS4D4B	Flo-Link x 1" Hose Barb
FIS4D4V	Flo-Link x 1" Hose Barb (with check valve)
FIS4D5B	Flo-Link x 1-1/4" Hose Barb
<b>Brass Adapters - Threaded</b>	
FIS4D4M	Flo-Link x 1" MPT
FIS4D4F	Flo-Link x 1" FPT
FIS4E4M	Flo-Link (female) x 1" MPT
FIS4D4J	Flo-Link x 1" FPT Full Port Isolation Valves
FIN4M4F	Flo-Link 1" MPT x 1" FPT 45Y angle
<b>Brass Adapters with Fitting for PT Port</b>	
FIS4T4B	Flo-Link x 1" Hose Barb with Fitting for PT Port
FIE4T4B	Flo-Link Elbow x 1" Hose Barb with Fitting for PT Port
FIS4T4M	Flo-Link x 1" MPT with Fitting for PT Port
FIE4T4M	Flo-Link Elbow x 1" MPT with Fitting for PT Port
FIS4DSS	Flo-Link x 1-1/8" Sweat with Fitting for PT Port
FIE4M4F	Flo-Link 1" MPT x 1" FPT Elbow with PT Plugs and Port
<b>Installation/Service Adapters</b>	
FIE4D4C	Flo-Link x Male Cam Adapter
FIS4D3G	Flo-Link by Male Garden Hose Adapter
FIS4D3H	Flo-Link x Female Garden Hose Adapter
<b>Threaded Fittings, Adapters and Other Fitting Components</b>	
FIE4M4B	1" MPT Elbow x 1" Hose Barb with Fitting for PT Port
FIS4M5B	1" MPT x 1-1/4" Hose Barb
FIE4A4A	Insulating Boot Set for 1" Elbows
FIS4Z4W	Water Heater Adapter (Use ASME Rated Water Heater as Buffer Tank)
FIS4M4C	1" MPT x 1" CAM, Aluminum

# Accessories

## Geothermal

Part Number	Description
<b>Loop Pressurization</b>	
ACPB	Pressure Battery (Polyethylene Expansion Tank) – Up to 6 Tons
ACGB	Geo-Booster (Loop Pressurization System – 35 psig)
ACGP	Geo-Prime Tank*
<b>Pressure/Temperature Plugs</b>	
ACPTP1	1/4" P/T Plug (each)
ACPTP2	1/2" P/T Plug (each)
<b>Controllers for Variable-Speed Flow Centers</b>	
ACVCT	Grundfos Magna GEO Controller(for NPV and NPV2) – Temperature Control (Hose Kit or PVC Connections – 1/4" MPT Immersion Thermistors Included)
ACVCFHB	Grundfos Magna GEO Controller (for NPV and NPV2) – Temperature and Flow Control for Hose Kit Connections
ACVCFPVC	Grundfos Magna GEO Controller (for NPV and NPV2) – Temperature and Flow Control for PVC Connections
<b>Two Heat Pump Flow Center Sharing Control</b>	
ACPSRN	Pump Sharing Relay (Two Units; One Flow Center) with NEMA encl.

\*Use with Flo-Link flow centers or insulated pumps. May also be used with GPM flow centers with Flo-Link female x 1" MPT adapter.

<b>NP Series Connector Kit</b>	
Part Number	Description
<b>NP Series Hose Kit with Three-Way Flushing/Purging Valve</b>	
ACCKNP	<p><b>Hose Kit Contents:</b></p> <p>Quantity 1: 12 ft. 1-inch ID Black Hose, 150 psi</p> <p>Quantity 4: Insulating Boot</p> <p>Quantity 2: Elbow, 1" MPT x 1" Hose Barb with PT Port (heat pump connections)</p> <p>Quantity 2: PT Plug, 1/4" MPT</p> <p>Quantity 2: Elbow, 1/4" Plugs, Flo-Link x 1" Hose Barb (flow center connections)</p> <p>Quantity 1: Three-Way Valve, Single, Composite, Flo-Link Fittings</p> <p>Quantity 1: 1-1/4" PE Fusion x Flo-Link (Three-way Valve Connection to Ground Loop)</p> <p>Quantity 1: Flo-Link x 1" Hose Barb (Three-Way Valve Connection to Heat Pump)</p> <p>Quantity 1: 1-1/4" PE Fusion x 1" Hose Barb (Ground Loop Connection to Hose at Flow Center, RH Side)</p> <p>Quantity 12: Hose Clamps</p>

Compatible with NP Series flow centers and heat pumps with 1" FPT connections.

<b>Unit Mounting Pad</b>	
Part Number	Description
ACMP2436	3/4" High Density Rubber Equipment Pad, 24" x 36"
ACMP2836	3/4" High Density Rubber Equipment Pad, 28" x 36"

Open Loop Accessories	
Part Number	Description
<b>Motorized Solenoid Valves</b>	
MVBR3F	Valve, Motorized Solenoid, Forged Brass 3/4" FPT, 24V with End Sw
MVBR4F	Valve, Motorized Solenoid, Forged Brass 1" FPT, 24V with End Sw
<b>Flow Regulator Valves</b>	
FR2	Valve, Flow Regulator, 3/4" FPT x 3/4" FPT, 2 GPM
FR3	Valve, Flow Regulator, 3/4" FPT x 3/4" FPT, 3 GPM
FR4	Valve, Flow Regulator, 3/4" FPT x 3/4" FPT, 4 GPM
FR5	Valve, Flow Regulator, 3/4" FPT x 3/4" FPT, 5 GPM
FR6	Valve, Flow Regulator, 3/4" FPT x 3/4" FPT, 6 GPM
FR7	Valve, Flow Regulator, 3/4" FPT x 3/4" FPT, 7 GPM
FR8	Valve, Flow Regulator, 3/4" FPT x 3/4" FPT, 8 GPM
FR9	Valve, Flow Regulator, 3/4" FPT x 3/4" FPT, 9 GPM

Fusion and Service Tools	
Part Number	Description
<b>Flush Care and Accessories</b>	
TLFLC2	Flush Cart*
TLFLH1	Hose Assembly, Flush Cart (set of 2, 10 feet) – 1" CAM Fittings (loop side)
FLFLH2	Hose Assembly, Flush Cart (set of 2, 10 feet) – 1-1/4" Ball Valves
TLFFLH3	Hose Assembly (set of 2, 20 feet) – 1-1/2" CAM Fittings (loop side)**
TLFB100	Filter Bag, 100 micron, for Flush Cart (each)
TLFB001	Filter Bag, One micron, for Flush Cart
<b>Loop Tools and Accessories</b>	
TLGG0	Geo-Gooser Loop Pressurization Device
TLDTH	Thermometer, Digital with Case
TLPG1	Pressure Gauge, 0-100 psig, 3-1/2" dial with PT Adapter
TLGAD	Gauge Adapter P/T Plug with Guard
TLHYD	Hydrometer, Alcohols
TLMFI	AC Magnetic Field Indicator (check pump operation)
TLFLK	Loop Service and Flush Kit

\*B12 Ships with Hose Set with 1-1/4" Ball Valve.

\*\*Ships with 2-CAM male x male adapters. May be used as an extension set or with Flo-Link XL Flow Centers.

Fusion and Service Tools for NP Series	
Part Number	Description
<b>GEO-Meter Flow Meter Tool</b>	
TLNPFMT	Mechanical (variable area) Flow Meter Tool
TLNPBDA	Adapter Kit or B and D Flow Meter Tool (allows B & D Tool to be used with NP Series Flow Centers)

Flow meter tool contains: Tool with fittings, 90° cam x double O-ring adapter, straight cam x double O-ring adapter, B & D adapter, and carrying case.

# Accessories

## Geothermal

Fusion and Service Tools for NP Series	
Part Number	Description
<b>Fusion Tools</b>	
TLHFD	Heat Fusion Tool – Double Face
TLFKT	Fusion Tool Kit 3/4", 1-1/4", and 2" Includes: Complete Fusion Tool Set (3/4", 1-1/4" and 2") Heating Tool with Cover, Socket Faces, Cold Rings, 1-1/4" and 2" Chamfer Tools, Tool Box Timer, Temple Sticks, Up to 2" Ratchet Cutter
<b>Socket Faces</b>	
TLSF3	3/4" IPS Socket Face Set
TLSF4	1" IPS Socket Face Set
TLSF5	1-1/4" IPS Socket Face Set
TLSF6	1-1/2" IPS Socket Face Set
TLSF8	2" IPS Socket Face Set
<b>Cold Rings Vice Grip Clamp</b>	
TLCR3	3/4" IPS Cold Ring Vice Grip Clamp
TLCR4	1" IPS Cold Ring Vice Grip Clamp
TLCR5	1-1/4" IPS Cold Ring Vice Grip Clamp
TLCR6	1-1/2" IPS Cold Ring Vice Grip Clamp
TLCR8	2" IPS Cold Ring Vice Grip Clamp
<b>Depth Gauge/Chamfer Tool</b>	
TLDG3	3/4" IPS Depth Gauge/Chamfer Tool
TLDG4	1" IPS Depth Gauge/Chamfer Tool
TLDG5	1-1/4" IPS Depth Gauge/Chamfer Tool
TLDG6	1-1/2" IPS Depth Gauge/Chamfer Tool
TLDG8	2" IPS Depth Gauge/Chamfer Tool
<b>Fusion Tools</b>	
TLFHO	Fitting Holder – 2" IPS
TLFTI	Fusion Timer
TLTS5	Temp Stick – PE, 500° F
TLMBR	Mounting Bracket for Fusion Tool
TLFHB	Fusion Tool Heater Bag
<b>Pipe Cutters</b>	
TLPC4	PE Cutter – Up to 1"
TLPC5	PE Ratchet Cutter – Up to 1-1/4"
TLPC8	PE Ratchet Cutter – Up to 2"

Auxiliary Heaters		
Part Number	Description	Used With
KWBEH0101N05	Non-Fused 5 Kw	HP 024-036, HB 018-036
KWBEH0101N10	Non-Fused 10 Kw	HP 024-036, HB 024-060
KWBEH0101N15	Breaker 15 Kw	HP 048-072, HB 036-060
KWBEH0101N20	Breaker 20 Kw	HP 060-072, HB 048-060







