



Modular Line 2022/23





About Carrier

Founded by the inventor of modern air conditioning, Carrier is the world's leader in high-technology heating, air conditioning and refrigeration solutions. Carrier experts provide sustainable solutions, integrating energy-efficient products, building controls and energy services for residential, commercial, retail, transport and food service customers.

With more than a century of expertise, we drive innovation while putting our customers first, helping protect our planet, and inspiring and empowering our people.



\$ 17.5B

2020
NET sales



~ 8.000

Active patents
and pending patent
applications worldwide



160+

countries



56,000

employees



80+

brands



100+

new products
for the 6th
consecutive year

Delivering confidence

through innovative & sustainable refrigeration solutions

Carrier Commercial Refrigeration is a part of Carrier Global Corporation and a leading supplier of innovative, sustainable and intelligent cold chain solutions in the food retail and cold storage industries.

Remote and plug-in cabinets. Chillers and freezers. Systems and controls. Carrier provides the design, installation, service and support your need to enjoy optimum performance – from day one through the entire life-cycle.

We deliver a comprehensive range of solutions to keep goods cool, energy costs low and environmental footprint to a minimum. Delivering confidence.



9.000+

connected stores



22.000+

sites maintained



700+

top trained technicians



50K+

Carrier Refrigeration products in stores and warehouses

For further information and contacts visit our website:
www.carrier-refrigeration.com



REMOTE
CABINETS



COUNTERS



PLUG-IN
CABINETS



MECHANICAL
SYSTEMS



SERVICES



Check our complete range of solutions, Naturally...

Content

Semi-Verticals & Multidecks

- Product Overview 8
- Prime Line**
 - E6 Mirado® & E6 Morea® 10
 - E6 Mirado® GS & E6 Morea® GS 12
 - E6 Methos 14
 - E6 Methos GD 16
 - E6 Monaxis® 20
 - E6 MonaxEco® 22
 - E6 Maress® & E6 Maress® GD 24
 - E6 Monaxis®-R 26
- Value Line**
 - E6 Mendos® 28
 - E6 MenEco® 30
 - E6 Mivit® & E6 Mivit® GD 32
- Ultrafresh Line**
 - E6 Mirado® FV 34
 - E6 Methos FV & E6 Mendos® FV 36
 - E6 Monaxis® FV & E6 Monaxis®-R FV 38
- Program options & accessories**
 - E6 Program Features 40
 - BREEZtec® 40
 - E6 Glass Door Program Multidecks 42
 - E6 Light Program 44
 - E6 Color Concept Multidecks 46
 - Endwalls 48
 - Bumpers 49
 - Accessories 52

Note:
 Technical data in European numeric signs: decimal comma

Vertical Freezers

- Product Overview 56
- Prime Line**
 - E6 Virando® 63 58
 - E6 Velando® 53 60
 - E6 Velando® AF 62
 - E6 Velando® QL AA CE 64
- Value Line**
 - E6 Velando® SG 63 66
- Program options & accessories**
 - Accessories 74
- Islands**
 - Product Overview 78
- Prime Line**
 - E6 Irios® GL 80
 - EasyGo 82
- Value Line**
 - Irios® GL+ 84
 - Ivando® GL+ & Wisalo® GL+ 86
 - AIB GL+ 88
- Program options & accessories**
 - Glass Lid Program 90
 - Light Program Islands 91
 - Color Concept E6 Irios® GL 92
 - Color Concept Islands GL+ 94
 - Accessories 96
- Technical Info**
 - The EcoDesign regulation 104
 - Powder Paint Selection Guide 106
 - Plug-in & remote cabinets in comparison 107
 - Excellence in tests and qualification of cabinets 108



Application

 Dairy products	 Cheese	 Meat	 Minced meat	 Cold cuts	 Fish	 Delicatessen
 Beverages	 Prepacked cheese	 Prepacked meat	 Prepacked minced meat	 Prepacked cold cuts	 Prepacked fish	 Prepacked delicatessen





Stainless steel bumper by local customization



Semi-Verticals & Multidecks

Overview Multidecks & Semi-Verticals

Standard front height

Narrow merchandiser

Maximum product facing in small spaces

Space optimizer

Maximum floor space productivity optimized for back-to-back installation



E6 Methos 53 open/GD



E6 Methos 63/83 open/GD



E6 Methos 53/63-GD
with 400mm doors



E6 Mirado® & E6 Morea®
open/GS

Ultrafresh Line



E6 Mirado® 64/84 FV



E6 Methos FV

Prime Line

Value Line



E6 Optimer® L open/G
(remote)*



E6 Mendos® EU/LU &
E6 MenEco® EU/LU

* For product information please see Compact Line brochure

Prime Line: Energy efficient design with a wide range of module lengths, options and accessories

Value Line: Focus on essential features with limited range of module lengths, options and accessories

Ultra low front height

Operation optimizer

Lowest maintenance and operation cost

Narrow displayer

Small footprint at highest total display area

Volume seller

Box stacking capability with a high turnover



E6 Monaxis® &
E6 MonaxEco®



E6 Maress® open/GD



E6 Mirado® 63 open/GS



E6 Monaxis®-R



E6 Monaxis® FV



E6 Mirado® 63 FV



E6 Monaxis®-R FV



E6 Mivit® 52 open/GD



E6 Mivit® GD 82

Optimized for CO₂OLtec® Evo

Adapted for Evolution 6 vertical cabinets, the 2nd generation CO₂OLtec® Evo system operates on natural refrigerant CO₂ and combines several innovations to optimize the total CO₂ system efficiency:

- Energy saving heat exchangers
- Ejector operation optimized expansion valves
- Extended operation flexibility: All 60 bar CO₂ evaporators now operate with 90 bar expansion valve and 90 bar liquid line

E6 Mirado® & E6 Morea®

Prime Line

Open semi-vertical multideck with a modern and space optimized design

Operation optimizer / Space optimizer



Benefits at a glance

- Maximum display opening by slim canopy
- Ergonomic height
- Floor space efficient design
- Enhanced visibility in the store

Standard configuration

- Manual night blinds
- Stepped display shelves with 40mm scanner price rails
- Integrated bumper and single-piece front kickplate
- Energy efficient EC fans
- Bottom evaporator (F-gas) / Mirado® 63.M1-2 with backwall evaporator (F-gas)
- Multiplex kit

Customization

- LED selection for canopy lighting, shelf lighting and front shelf lighting
- Stainless steel interior
- Large selection of shelves, price rails and front stoppers
- Plinth bumper for increased protection
- Bottom evaporator (CO₂) / Mirado® 63.M1-2 with backwall evaporator (CO₂)
- Reinforced (additional) front bumper

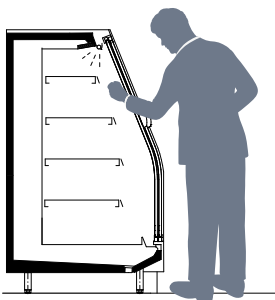

The semi-vertical size provides ergonomic height and customer contact on eye level



The maximum display opening and the stepped display shelves offer the best presentation of your products



The backwall evaporator of Mirado® 63 provides benefits such as a maximum front opening and self cleaning effect by defrosting

Technical data



	Customer value	Morea®	Mirado®
Prime Line	Heavy product load	■	■ ■ ■ ■ ■
	Energy efficiency	■ ■ ■ ■ ■	■ ■ ■ ■ ■
	Streamlined operation	■ ■ ■ ■ ■	■ ■ ■ ■ ■
	Product visibility	■ ■ ■ ■ ■	■ ■ ■ ■ ■
	Installation/Serviceability	■ ■ ■ ■ ■	■ ■ ■ ■ ■
	Floor space productivity	■ ■ ■ ■ ■	■ ■ ■ ■ ■
	Cabinet aesthetics	■ ■ ■ ■ ■	■ ■ ■ ■ ■

Mirado® 84 - 250 M1 - 1

Name of product line

Bottom shelf depth: ~ 800 mm

Front height: ~ 400 mm

Cabinet length: ~ 2 500 mm

Temperature class: M1*

Revision index: 1

*Cabinet design according to EN ISO 23953 at climate class 3

Operation optimizer

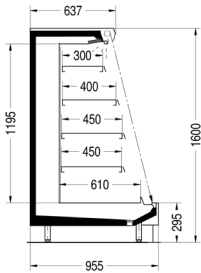

Mirado® 63.M1-2

Space optimizer

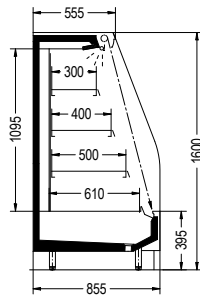

Mirado® 64.M1-1

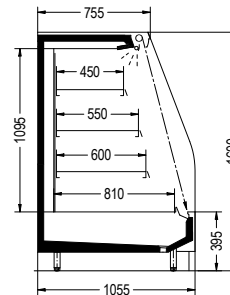

Mirado® 84.M1-1

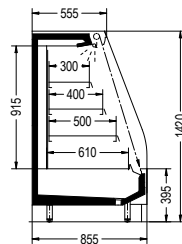

Morea® 64.M1-1

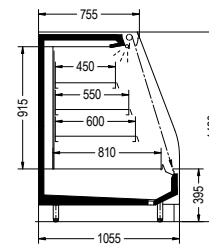

Morea® 84.M1-1



Supermarket



Hypermarket



Discounter

E6 Mirado® & E6 Morea®	Unit	Mirado®			Morea®	
		63	64	84	64	84
Internal height	mm	1195	1095	1095	915	915
Bottom shelf depth	mm	610	610	810	610	810
Shelf depth (min. / standard / max.)	mm	300 / - / 450	300 / - / 500	400 / - / 600	300 / - / 500	400 / - / 600
Shelves (min. / standard / max.)	rows	3 / 4 / 4	3 / 3 / 4	1 / 3 / 4	1 / 3 / 3	1 / 3 / 3
Module length without endwalls (40 mm each)	125	✓	✓	✓	✓	✓
	170	-	✓	-	✓	-
	188	✓	✓	✓	✓	✓
	210	-	✓	✓	✓	✓
	250	✓	✓	✓	✓	✓
375	✓	✓	✓	✓	✓	
Temperature class M1 / Storage temp. -1/+1 °C		✓	✓	✓	✓	✓
Energy Label*						

* Label might change depending on configuration

E6 Mirado® GS & E6 Morea® GS

Prime Line

Closed semi-vertical multideck with a modern and space optimized design

Operation optimizer / Space optimizer



Benefits at a glance

- Maximum display opening by slim canopy
- Ergonomic height
- Floor space efficient design
- Enhanced visibility in the store

Standard configuration

- Sliding fully Transparent door
- Stepped display shelves with 40mm scanner price rails
- Integrated bumper and single-piece front kickplate
- Energy efficient EC fans
- Bottom evaporator (F-gas) / Mirado® 63-GS.M1-2 with backwall evaporator (F-gas)
- Multiplex kit

Customization

- Horizontal LED lighting for canopy, shelf and front shelf
- Stainless steel interior
- Large selection of shelves, price rails and front stoppers
- Plinth bumper for increased protection
- Bottom evaporator (CO₂) / Mirado® 63-GS.M1-2 with backwall evaporator (CO₂)
- Reinforced (additional) front bumper

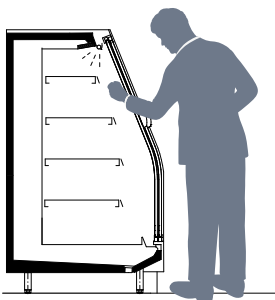

The semi-vertical size provides ergonomic height and customer contact on eye level



The standard bottom evaporator ensures a balanced floor space efficient design for the best placement in the center of your store, no matter if supermarket, hypermarket or discounter

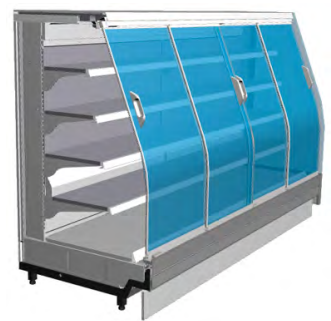

Mirado® 63-GS comes with backwall evaporator which provides maximum display opening together with high service durability of fans and evaporator

Technical data



	Customer value	Morea® GS	Mirado® GS
Prime Line	Heavy product load	■	■
	Energy efficiency	■	■
	Streamlined operation	■	■
	Product visibility	■	■
	Installation/Serviceability	■	■
	Floor space productivity	■	■
	Cabinet aesthetics	■	■

Mirado® 84 - GS - 250 M1 - 1

Name of product line

Bottom shelf depth: 8 - 800 mm

Front height: 4 - 400 mm

Glass door (Sliding)

Cabinet length: ~ 2 500 mm

Temperature class: M1*

Revision index: 1

*Cabinet design according to EN ISO 23953 at climate class 3

Operation optimizer

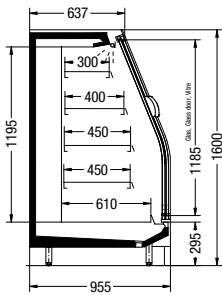

Mirado® 63-GS.M1-2

Space optimizer

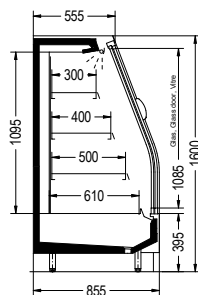

Mirado® 64-GS.M1-1

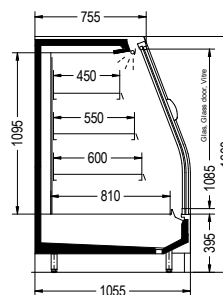

Mirado® 84-GS.M1-1

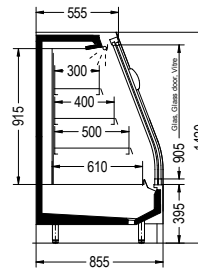

Morea® 64-GS.M1-1

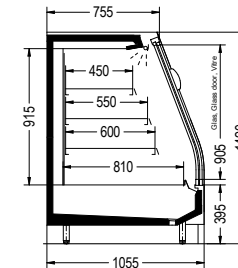

Morea® 84-GS.M1-1



Supermarket



Hypermarket



Discounter

E6 Mirado® GS & E6 Morea® GS	Unit	Mirado® GS			Morea® GS	
		63	64	84	64	84
Internal height	mm	1195	1095	1095	915	915
Bottom shelf depth	mm	610	610	810	610	810
Shelf depth (min. / standard / max.)	mm	300 / - / 450	300 / - / 500	400 / - / 600	300 / - / 500	400 / - / 600
Shelves (min. / standard / max.)	rows	3 / 4 / 4	3 / 3 / 4	1 / 3 / 4	1 / 3 / 3	1 / 3 / 3
Module length without endwalls (40mm each)	125	✓	✓	✓	✓	✓
	170	-	✓	-	✓	-
	188	✓	✓	✓	✓	✓
	210	-	✓	✓	✓	✓
	250	✓	✓	✓	✓	✓
375	✓	✓	✓	✓	✓	
Temperature class M1 / Storage temp. -1/+1 °C		✓	✓	✓	✓	✓
Energy Label*		A	C	A	C	A

* Label might change depending on configuration

E6 Methos

Prime Line

Open multideck with an optimized footprint and best customizable design

Narrow merchandiser / Space optimizer



Benefits at a glance

- Highest footprint productivity
- Largest selection of configurations
- Easy access to evaporator and fans
- Optimized design for back-to-back installation

Standard configuration

- Motorized night blind (30-50% less energy consumption)
- Display shelves with single side coating and 40 mm scanner price rails
- Integrated bumper and kickplate
- Energy efficient EC fans
- Bottom evaporator (F-gas)
- Multiplex kit

Customization

- Horizontal LED lighting for canopy, shelf and front shelf
- Dimming box for Premium LED lighting
- Stainless steel interior
- Large selection of shelves, price rails and front stoppers
- Reinforced (additional) front bumper
- Bottom evaporator (CO₂)



The installed bottom evaporator provides the best floor space productivity among all multideck cabinets for your turnover



Reinforced (additional) front bumper for increased protection of the cabinet



The optimized small footprint design makes the Methos multidecks perfect for space saving back-to-back installations in your market (stainless steel bumper by local customization)

Technical data



	Customer value	Methos
Prime Line	Heavy product load	■ ■ ■ ■
	Energy efficiency	■ ■ ■ ■ ■ ■ ■ ■
	Streamlined operation	■ ■ ■ ■ ■ ■ ■ ■ ■ ■
	Product visibility	■ ■ ■ ■ ■ ■ ■ ■ ■ ■ ■ ■
	Installation/ Serviceability	■ ■ ■ ■ ■ ■ ■ ■ ■ ■ ■ ■ ■ ■
	Floor space productivity	■ ■ ■ ■ ■ ■ ■ ■ ■ ■ ■ ■ ■ ■ ■ ■
	Cabinet aesthetics	■ ■ ■ ■ ■ ■ ■ ■ ■ ■ ■ ■ ■ ■ ■ ■ ■ ■

Methos 53 250 M1 1 L

Name of product line

Bottom shelf depth: 5 – 500 mm

Front height: 3 – 300 mm

Cabinet length: ~ 2 500 mm

Temperature class: M1*

Revision index: 1

Cabinet height: L = ~ 2 220 mm

* Cabinet design according to EN ISO 23953 at climate class 3

Narrow merchandiser

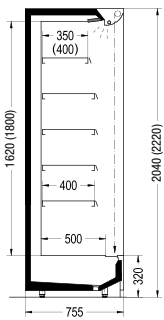

Methos 53.M1/M2-1 (L)



Small Store

Space optimizer

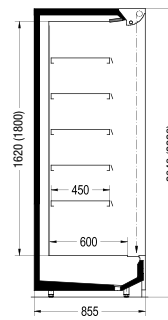

Methos 63.M1/M2-1 (L)



Supermarket

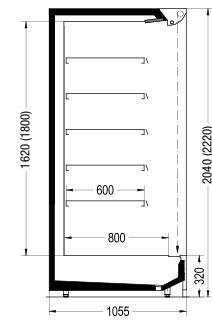

Methos 83.M1/M2-1 (L)



Hypermarket

E6 Methos	Unit	53	63	83
Internal height STD-height	mm	1620	1620	1620
Internal height L-height	mm	1800	1800	1800
Bottom shelf depth	mm	500	600	800
Shelf depth (min. / standard / max.)	mm	350 / 350 (400)* / 400	400 / 450 / 500	400 (500)** / 600 / 600
Shelves STD-height (min. / standard / max.)	rows	4 / 4 / 5	3 / 4 / 6	3 / 4 / 6
Shelves L-height (min. / standard / max.)	rows	4 / 5 / 6	4 / 5 / 7	4 / 5 / 7
Load per module	kg / 125cm	510	665	820
Module length without endwalls (40mm each)	125	✓	✓	✓
	150	✓	-	-
	170	-	✓	-
	188	✓	✓	✓
	210	-	✓	-
	250	✓	✓	✓
375	✓	✓	✓	
Temperature class M1 / Storage temp. -1/+1 °C		✓	✓	✓
Energy label***		F	F	F
Temperature class M2 / Storage temp. 0/+2 °C		✓	✓	✓
Energy label***		G	G	G

* Alternative shelf depth | ** Minimum shelf depth for temperature class M2 | *** Label might change depending on configuration

E6 Methos GD

Prime Line

Closed multideck with an optimized footprint and best customizable design

Narrow merchandiser / Space optimizer



Benefits at a glance

- Highest footprint productivity
- Largest selection of configurations
- Optimized design for back-to-back installation
- Easy access of evaporator and fans

Standard configuration

- Swing insulated All-glass Frameless door with small dark grey print and solid mullion
- Display shelves with single side coating and 40 mm scanner price rails
- Integrated bumper and kickplate
- Energy efficient EC fans
- Bottom evaporator (F-gas)
- Multiplex kit

Customization

- Large selection of various door options:
 - Swing fully Transparent door with or without mullion (Transparent Gap Cover)
 - Swing fully Transparent door with Anti-reflex coating with or without mullion (Transparent Gap Cover)
 - Ultra slim fully Transparent 400mm door with or without mullion (Transparent Gap Cover)
- Horizontal LED lighting for canopy, shelf and front shelf
- Vertical LED lighting for door mullion, dividing wall and endwall
- Dimming box for Premium LED lighting
- Stainless steel interior
- Large selection of shelves, price rails and front stoppers
- Reinforced (additional) front bumper
- Bottom evaporator (CO₂)



The installed bottom evaporator provides the best floor space productivity among all multideck cabinets for your turnover



The optimized small footprint design makes the Methos GD multidecks perfect for space saving back-to-back installations in your market (Inox bumper by local customization)

E6 Methos GD with 400 mm Doors



Benefits at a glance

- Slim 400 mm doors for high footprint sales productivity
- Space saving design for small stores with narrow aisles
- Full transparent door parts for better product visibility



Opened 400 mm slim doors provide 35 % floor space saving compared to 625 mm standard doors

E6 Methos GD with 400 mm Doors	53	63	
Available module lengths without endwalls (40 mm each)	125	✓	✓
	250	✓	✓
	375	✓	✓



Wood optic cladding made by local customization



Semi-Verticals & Multidecks



E6 Monaxis®

Prime Line

Open multideck for best product presentation with lowest life cycle costs

Operation optimizer



Benefits at a glance

- Lowest life cycle costs
- Best maintenance conditions
- Energy efficient design
- Attractive product presentation

Standard configuration

- Low front height (295 mm)
- Carrier's Temperature Equalizer System
- Double air curtain for cabinets with temperature class M1 (approx. 10% less energy consumption)
- Display shelves with 40mm scanner price rails and product stoppers
- Integrated front bumper and kickplate
- BREEZtec® EC fans (Carrier's Next Generation Air Circulation System) available in H2 2022
- Backwall evaporator (F-gas)
- Multiplex kit

Customization

- Night blind options:
 - Motorized (30-50% less energy consumption)
 - Motorized with efficient cover (40-70% less energy consumption)
 - Manual night blind cover (30% less energy consumption)
- Horizontal LED lighting for canopy, shelf and front shelf
- Dimming box for Premium LED lighting
- Stainless steel interior
- Large selection of shelves, price rails and front stoppers
- Reinforced (additional) front bumper and endwall
- Plinth front bumper and endwall
- Backwall evaporator (CO₂)



The backwall evaporator enables easy installation and maintenance due to a total clearance height of 125 mm



The closed motorized nightblind with efficient cover saves 40-70% energy compared to the open operation



Easy to clean bottom area by backwall evaporator with simple access of the expansion valve

Technical data



	Customer value	Monaxis®				
Prime Line	Heavy product load	■	■	■	■	■
	Energy efficiency	■	■	■	■	■
	Streamlined operation	■	■	■	■	■
	Product visibility	■	■	■	■	■
	Installation/ Serviceability	■	■	■	■	■
	Floor space productivity	■	■	■	■	■
	Cabinet aesthetics	■	■	■	■	■

Monaxis®	83	250	M1	1	DL
Name of product line					
Bottom shelf depth: 8 – 800 mm					
Front height: 3 – 300 mm					
Cabinet length: – 2 500 mm					
Temperature class: M1*					
Revision index: 1					
Dual air curtain					
Cabinet height: L= – 2 220 mm					

*Cabinet design according to EN ISO 23953 at climate class 3

Operation optimizer

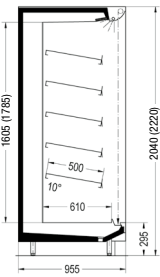

Monaxis® 63.M1-1 D (DL)

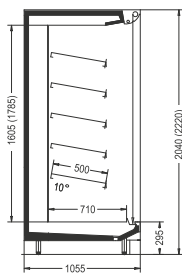

Monaxis® 73.M1-1 D (DL)

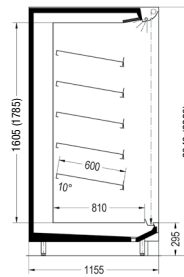

Monaxis® 83.M1-1 D (DL)

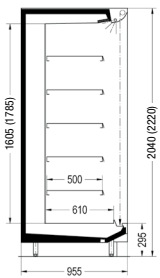

Monaxis® 63.M2-1 (L)

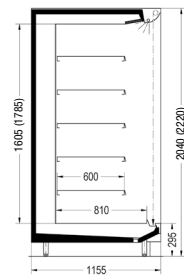

Monaxis® 83.M2-1 (L)



Supermarket

Hypermarket



Discounter

E6 Monaxis®	Unit	63	73	83
Internal height STD-height	mm	1605	1605	1605
Internal height L-height	mm	1785	1785	1785
Bottom shelf depth	mm	610	710	810
Shelf depth (min. / standard / max.)	mm	350 / 500 / 500	350 / 500 / 500	450 / 600 / 600
Shelves STD-height (min. / standard / max.)	rows	3 / 4 / 6	3 / 4 / 6	3 / 4 / 6
Shelves L-height (min. / standard / max.)	rows	4 / 5 / 7	4 / 5 / 7	4 / 5 / 7
Load per module	kg / 125cm	690	690	850
Module length without endwalls (40mm each)	125	✓	✓	✓
	188	✓	✓	✓
	230	✓	-	✓
	250	✓	✓	✓
	375	✓	✓	✓
Temperature class M1 / Storage temp. -1/+1 °C		✓	✓	✓
		A+G E	A+G E	A+G E
Energy label*		A+G E	A+G E	A+G E
Temperature class M2 / Storage temp. 0/+2 °C		✓	-	✓
		A+G E	-	A+G E
Energy label*		A+G E	-	A+G E

* Label might change depending on configuration

E6 MonaxEco[®]

Prime Line

Closed multideck with attractive design and lowest life cycle costs

Operation optimizer



Benefits at a glance

- Lowest life cycle costs
- Best maintenance conditions
- Energy efficient design
- Attractive product presentation

Standard configuration

- Low front height (295 mm)
- Carrier's Temperature Equalizer System
- Swing insulated All-glass Frameless door with small dark grey print and solid mullion
- Display shelves with 40 mm scanner price rails
- Integrated front bumper and kickplate
- BREEZtec[®] EC fans (Carrier's Next Generation Air Circulation System)
- Backwall evaporator (F-gas)
- Multiplex kit

Customization

- Large selection of door options:
 - Swing fully Transparent door with or without mullion (Transparent Gap Cover)
 - Swing fully Transparent door with Anti-reflex coating with or without mullion (Transparent Gap Cover)
- Horizontal LED lighting for canopy, shelf and front shelf
- Vertical LED lighting for door mullion, dividing wall and endwall
- Dimming box for Premium LED lighting
- Stainless steel interior
- Large selection of shelves, price rails and front stoppers
- Reinforced (additional) front bumper and endwall
- Plinth front bumper and endwall
- Backwall evaporator (CO₂)



The backwall evaporator enables easy installation and maintenance due to a total clearance height of 125 mm



The low front height of 295 mm provides for attractive cabinet aesthetics



Low energy consumption and short maintenance time secure extreme low life cycle costs

Technical data



	Customer value	MonaxEco®
Prime Line	Heavy product load	■ ■ ■ ■ ■
	Energy efficiency	■ ■ ■ ■ ■ ■ ■ ■ ■ ■
	Streamlined operation	■ ■ ■ ■ ■ ■ ■ ■ ■ ■
	Product visibility	■ ■ ■ ■ ■ ■ ■ ■ ■ ■
	Installation/Serviceability	■ ■ ■ ■ ■ ■ ■ ■ ■ ■
	Floor space productivity	■ ■ ■ ■ ■ ■ ■ ■ ■ ■
	Cabinet aesthetics	■ ■ ■ ■ ■ ■ ■ ■ ■ ■

MonaxEco® 83 250 M0 1 L

Name of product line

Bottom shelf depth: 8 – 800 mm

Front height: 3 – 300 mm

Cabinet length: – 2 500 mm

Temperature class: M0*

Revision index: 1

Cabinet height: L – 2 220 mm

*Cabinet design according to EN ISO 23953 at climate class 3

Operation optimizer

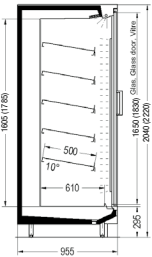

MonaxEco® 63.M0-1 (L)

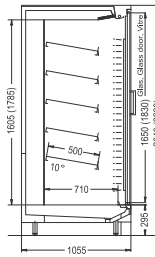

MonaxEco® 73.M0-1 (L)

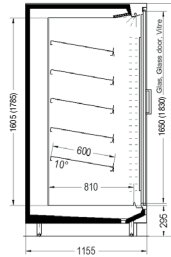

MonaxEco® 83.M0-1 (L)

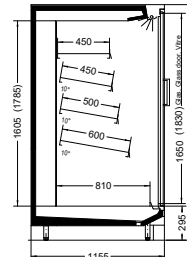

MonaxEco® 83.S0-1 (L)

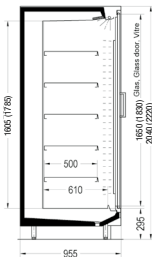

MonaxEco® 63.M2-1 (L)

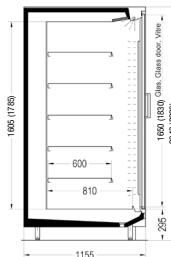

MonaxEco® 83.M2-1 (L)



Supermarket



Hypermarket

E6 MonaxEco®	Unit	63	73	83
Internal height STD-height	mm	1605	1605	1605
Internal height L-height	mm	1785	1785	1785
Bottom shelf depth	mm	610	710	810
Shelf depth (min. / standard / max.)	mm	350 (400)* / 500 / 500	350 / 500 / 500	450 / 600 / 600
Shelves STD-height (min. / standard / max.)	rows	3 / 4 / 6	3 / 4 / 6	3 / 4 / 6
Shelves L-height (min. / standard / max.)	rows	4**** / 5 / 7	4**** / 5 / 7	4**** / 5 / 7
Load per module	kg / 125 cm	690	690	850
Module length without endwalls (40 mm each)	125	✓	✓	✓
	188	✓	✓	✓
	230	✓	-	✓
	250	✓	✓	✓
	375	✓	✓	✓
Temperature class M0 / Storage temp. -2/0 °C		✓	✓	✓
Energy label ***		A ↑ G D	A ↑ G D	A ↑ G D
Temperature class M2 / Storage temp. 0/+2 °C		✓	-	✓
Energy label ***		A ↑ G C	-	A ↑ G D
Temperature class S0 / Storage temp. -2/-1 °C**		-	-	✓
Energy label ***		-	-	A ↑ G D

* Minimum shelf depth for temperature class M2 | ** Recommended according to German standard DIN 10508 "Food hygiene – Temperature requirements for foodstuffs"

*** Label might change depending on configuration | **** 3 rows as a minimum for MonaxEco® with the temperature class M0

E6 Maress® & E6 Maress® GD

Prime Line

Open/closed multideck for heavy product load with optimized life cycle cost

Volume seller



Benefits at a glance

- Maximum front opening
- Perfect design for heavy product load & box stacking
- Short service and maintenance times
- Optimized life cycle cost

Standard configuration

- Ultra-low front (220 mm)
- Carrier's Temperature Equalizer System
- Open cabinets with double air curtain (approx. 10% less energy consumption)
- Closed cabinets with swing fully Transparent door with solid mullion
- Display shelves (open cabinet with heavy-duty bottom display deck)
- Integrated front bumper and kickplate
- BREEZtec® EC fans (Carrier's Next Generation Air Circulation System)
- Backwall evaporator (F-gas)
- Multiplex kit
- Maress® 82.M2-2 D with motorized night blind (30-50% less energy consumption)

Customization

- Night blind options for open cabinets:
 - Motorized (30-50% less energy consumption)
 - Motorized with efficient cover (40-70% less energy consumption)
- Closed cabinets with large selection of door options:
 - Swing fully Transparent door without mullion (Transparent Gap Cover)
 - Swing fully Transparent door with Anti-reflex coating with or without mullion (Transparent Gap Cover)
- Horizontal LED lighting for canopy, shelf and front shelf
- Closed cabinets with vertical LED lighting for door mullion, dividing wall and endwall
- Dimming box for Premium LED lighting
- Stainless steel interior
- Large selection of shelves, price rails and front stoppers
- Backwall evaporator (CO₂)



The backwall evaporator enables easy installation with short service and maintenance times



The ultra-low front height of only 220 mm provides a maximum front opening



The Maress® product family is perfectly designed for heavy product load and stacking of boxes

Technical data



	Customer value	Maress®	Maress® GD
Prime Line	Heavy product load	■	■
	Energy efficiency	■	■
	Streamlined operation	■	■
	Product visibility	■	■
	Installation/Serviceability	■	■
	Floor space productivity	■	■
	Cabinet aesthetics	■	■

Maress® 82 . 375 M2 - 2 DL

Name of product line

Bottom shelf depth: ~ 800 mm

Front height: ~ 200 mm

Cabinet length: ~ 3 750 mm

Temperature class: M2*

Revision index: 2

Dual air curtain

Cabinet height: L= ~ 2 220 mm

*Cabinet design according to EN ISO 23953 at climate class 3

Volume seller

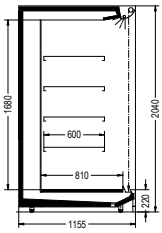

Maress® 82.M2-2 D

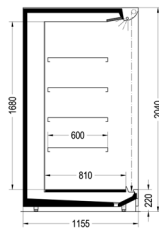

Maress® 82.M1-1 D

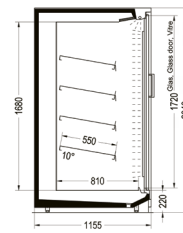

Maress® 82-GD.M0-1

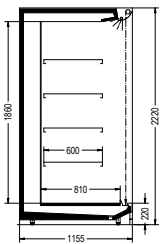

Maress® 82.M2-2DL

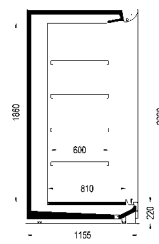

Maress® 82.M1-1DL

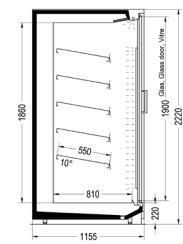

Maress® 82-GD.M0-1L



Discounter

E6 Maress® & E6 Maress® GD	Unit	Maress®		Maress® GD
		82	82	82
Internal height STD-height	mm	1680	1680	1680
Internal height L-height	mm	1860	1860	1860
Bottom shelf depth	mm	810	810	810
Shelf depth (min. / standard / max.)	mm	500 / 600 / 600	500 / 600 / 600	450 / 550 / 600
Shelves STD-height (min. / standard / max.)	rows	3 / 4 / 7	3 / 4 / 7	3 / 4 / 7
Shelves L-height (min. / standard / max.)	rows	3 / 4 / 8	3 / 4 / 8	3 / 5 / 8
Load per module	kg / 125 cm	1160	1160	850
Module length without endwalls (40 mm each)	125	✓	✓	✓
	188	✓	✓	✓
	250	✓	✓	✓
	375	✓	✓	✓
Temperature class M0 / Storage temp. -2/0 °C		-	-	✓
Energy label*		-	-	A+ G D
Temperature class M1 / Storage temp. -1/+1 °C		-	✓	-
Energy label*		-	A+ G E	-
Temperature class M2 / Storage temp. 0/+2 °C		✓	-	-
Energy label*		A+ G F	-	-

* Label might change depending on configuration

E6 Monaxis[®]-R

Prime Line

Open roll-in multideck with a robust & energy efficient design

Volume seller



Benefits at a glance

- Robust cabinet for heavy product load
- Fast and easy loading
- Hygienic cabinet design

Standard configuration

- Lifiable Low front height (295 mm)
- Motorized night blind (30-50% less energy consumption)
- Easy to use front lift allows use of roll-in trolley
- Carrier's Temperature Equalizer System
- Dual air curtain for approx. 10% less energy consumption
- Display shelves with wire fences (lower shelf with air control) with 40 mm scanner price rails
- Integrated front bumper and kickplate
- Energy efficient EC fans
- Backwall evaporator (F-gas)
- Multiplex kit

Customization

- Motorized night blind with efficient cover (40-70% less energy consumption)
- Horizontal LED lighting for canopy, shelf and front shelf
- Dimming box for Premium LED lighting
- Large selection of shelves, price rails & front stopper
- Reinforced (additional) front bumper and endwall
- Backwall evaporator (CO₂)



Robust cabinet design for heavy product load and box stacking



The easy-to-handle, movable front mechanism, allows the use of roll-in trolleys or pallets for stocking of heavy stacked products

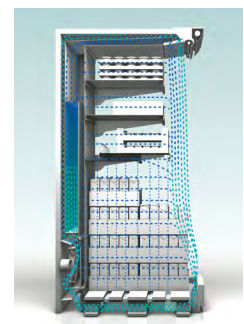

The dual air curtain provides optimized temperature distribution inside the Roll-in cabinet

Technical data



	Customer value	Monaxis® -R
Prime Line	Heavy product load	[X]
	Energy efficiency	[X]
	Streamlined operation	[X]
	Product visibility	[X]
	Installation/Serviceability	[X]
	Floor space productivity	[X]
	Cabinet aesthetics	[X]

Monaxis® 83 - R . 250 M2 - 1 DL

Name of product line
 Bottom shelf depth: 8 ~ 800 mm
 Front height: 3 ~ 300 mm
 Cabinet type: R – Roll-in
 Cabinet length: ~ 2 500 mm
 Temperature class: M2*
 Revision index: 1
 Dual air curtain
 Cabinet height: L= ~ 2 220 mm

*Cabinet design according to EN ISO 23953 at climate class 3

Volume seller

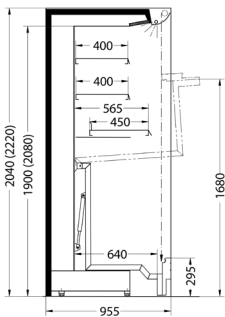

Monaxis® 63-R.M2-1 D (L)

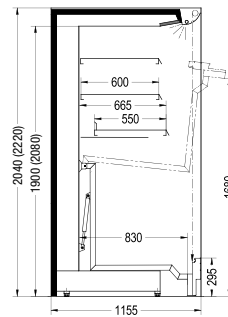

Monaxis® 83-R.M2-1 D (L)



Hypermarket



Discounter

E6 Monaxis® -R	Unit	Monaxis® -R	
		63	83
Internal height STD-height	mm	1900	1900
Internal height L-height	mm	2080	2080
Inside bottom depth	mm	640	830
Shelf depth (min. / standard / max.)	mm	400 / 400 (450)* / 550	500 / (550)* 600 / 600
Shelves STD-height (min. / standard / max.)	rows	1 / 2 / (6)**	1 / 2 / (6)**
Shelves L-height (min. / standard / max.)	rows	2 / 3 / (6)**	2 / 3 / (6)**
Load per module	kg / 125 cm	600	600
Module length without endwalls (40 mm each)	140	-	✓
	250	✓	✓
	280	-	✓
	375	✓	✓
Temperature class M2 / Storage temp. 0/+2 °C		✓	✓
Energy label***		A+ G F	A+ G F

* Air guided shelf above roll-in trolley | ** Without roll-in trolley | *** Label might change depending on configuration

E6 Mendos®

Value Line

Basic open multideck with the highest footprint productivity

Space optimizer



Benefits at a glance

- Very high footprint productivity
- Optimized design for back-to-back installations
- Easy access of evaporator and fans

Standard configuration

- Motorized night blind (30-50% less energy consumption)
- Display shelves with single side coating and 40 mm scanner price rails
- Integrated bumper and kickplate
- Energy efficient EC fans
- Bottom evaporator (F-gas)
- Multiplex kit

Customization

- Horizontal LED lighting for canopy, shelf and front shelf
- Large selection of shelves, price rails and front stoppers
- Bottom evaporator (CO₂)
- Transparent raised front to reduce energy consumption



The installed bottom evaporator provides the best floor space productivity among all multideck cabinets for your turnover



Backwall mirrors greatly enhance product visibility

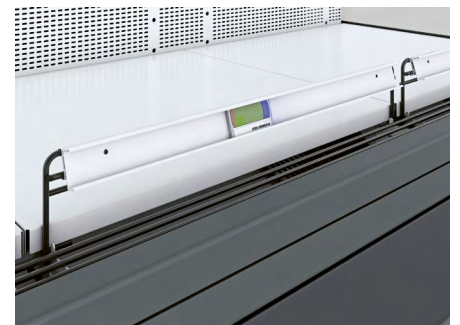

Product stoppers protect air flow and improve presentation

Technical data



VALUE LINE	Customer value	Mendos®
	Heavy product load	
	Energy efficiency	
	Streamlined operation	
	Product visibility	
	Installation/Serviceability	
	Floor space productivity	
	Cabinet aesthetics	

	Mendos®	EU	250	EP	A	L
Name of product line						
Bottom shelf depth:						
E ~ 600, L ~ 800 mm						
Front height: U ~ 320 mm						
Cabinet length: ~ 2 500 mm						
Temperature class:						
XP ~ M0, HP ~ M1, EP ~ M2*						
Revision index: A						
Cabinet height: L ~ 2 220 mm						

*Cabinet design according to EN ISO 23953 at climate class 3

Space optimizer

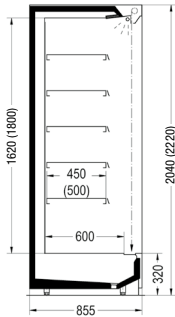

Mendos® EU,EP-A (L)

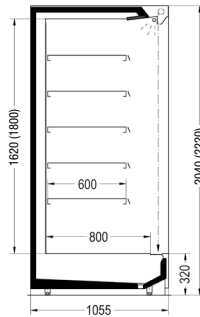

Mendos® LU,EP-A (L)



E6 Mendos®	Unit	EU (63)	LU (83)
Internal height STD-height	mm	1620	1620
Internal height L-height	mm	1800	1800
Bottom shelf depth	mm	600	800
Shelf depth (min. / standard / max.)	mm	400 / 450 / 500	500 / 600 / 600
Shelves STD-height (min. / standard / max.)	rows	3 / 4 / 6	3 / 4 / 6
Shelves L-height (min. / standard / max.)	rows	4 / 5 / 7	4 / 5 / 7
Load per module	kg / 125cm	665	820
Module length without endwalls (40mm each)	125	✓	✓
	188	✓	✓
	250	✓	✓
	375	✓	✓
Temperature class M1 / Storage temp. -1/+1 °C 		-	-
Energy Label**		-	-
Temperature class M2 / Storage temp. 0/+2 °C 		✓	✓
Energy Label**			

* Alternative shelf depth | ** Label might change depending on configuration

Basic closed multideck with the highest footprint productivity

Space optimizer



Benefits at a glance

- Very high footprint productivity
- Optimized design for back-to-back installations
- Easy access of evaporator and fans

Standard configuration

- Swing insulated All-glass Frameless door with small light grey print and solid mullion
- Display shelves with single side coating and 40 mm scanner price rails
- Integrated bumper and kickplate
- Energy efficient EC fans
- Bottom evaporator (F-gas)
- Multiplex kit

Customization

- Horizontal LED lighting for canopy, shelf and front shelf
- Vertical LED lighting for door mullion, dividing wall and endwall
- Large selection of shelves, price rails and front stoppers
- Bottom evaporator (CO₂)



The installed bottom evaporator provides the best floor space productivity among all multideck cabinets for your turnover



All-glass doors with light grey print provide a seamless produce view



Display grids and product stoppers are available for base shelves

Technical data

VALUE LINE	Customer value	MenEco®
	Heavy product load	■ ■ ■ ■ ■
	Energy efficiency	■ ■ ■ ■ ■
	Streamlined operation	■ ■ ■ ■ ■
	Product visibility	■ ■ ■ ■ ■
	Installation/Serviceability	■ ■ ■ ■ ■
	Floor space productivity	■ ■ ■ ■ ■ ■ ■ ■ ■ ■ ■
	Cabinet aesthetics	■ ■ ■ ■ ■



MenEco® LU . 375 HP - A L

Name of product line

Eco: Closed cabinet with Glass Door

Bottom shelf depth:

E ~ 600, L ~ 800 mm

Front height: U ~ 320 mm

Cabinet length: ~ 3 750 mm

Temperature class:

XP ~ M0, HP ~ M1, EP ~ M2*

Revision index: A

Cabinet height: L= ~ 2 220 mm

*Cabinet design according to EN ISO 23953 at climate class 3

Space optimizer

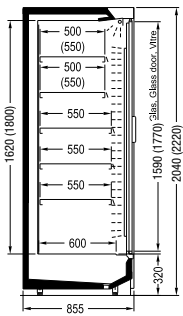

MenEco® EU.HP-A (L)

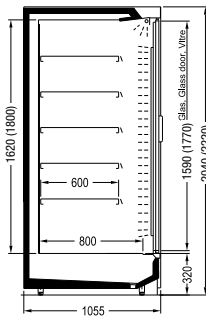

MenEco® LU.HP-A (L)



E6 MenEco®	Unit	EU (63)	LU (83)
Internal height STD-height	mm	1620	1620
Internal height L-height	mm	1800	1800
Bottom shelf depth	mm	600	800
Shelf depth (min. / standard / max.)	mm	400 / 500 (550)* / 550	400 / 600 / 600
Shelves STD-height (min. / standard / max.)	rows	3 / 4 / 6	3 / 4 / 6
Shelves L-height (min. / standard / max.)	rows	4 / 5 / 7	4 / 5 / 7
Load per module	kg / 125cm	665	730
Module length without endwalls (40 mm each)	125	✓	✓
	188	✓	✓
	250	✓	✓
	375	✓	✓
Temperature class M0 / Storage temp. -2/0 °C 		-	-
Energy label**		-	-
Temperature class M1 / Storage temp. -1/+1 °C 		✓	✓
Energy label**			

* Alternative shelf depth | ** Label might change depending on configuration

E6 Mivit[®] & E6 Mivit[®] GD

Value Line

Basic multideck design with high standards

Narrow displayer / Volume seller



Benefits at a glance

- Maximum front opening
- Open/closed E6 Mivit[®] 52 with slim footprint at highest total display area
- E6 Mivit[®] 82 GD designed for box stacking capacity for high turnover

Standard configuration

- Ultra-low front (220 mm)
- Closed cabinets with swing insulated All-glass Frameless door with small light grey print and solid mullion
- Display shelves and 40 mm scanner price rails
- Integrated bumper and kickplate
- Back evaporator (F-gas)
- Multiplex kit
- Mivit[®] 52 open & closed with BREEZtec[®] EC fans (Carrier's Next Generation Air Circulation System)

Customization

- Night blind options for open cabinets:
 - Motorized (30-50 % less energy consumption)
 - Motorized with efficient cover (40-70 % less energy consumption)
- Closed cabinets with swing fully Transparent door and solid mullion
- Horizontal LED lighting for canopy, shelf and front shelf
- Closed cabinets with vertical LED lighting
- Backwall evaporator (CO₂)
- Transparent raised front for Mivit[®] 52 to reduce energy consumption



The backwall evaporator provides maximum display opening and self cleaning effect by defrosting



The ultra-low front height of only 220 mm provides a maximum front opening



Easy to clean bottom area by backwall evaporator with simple access of the expansion valve

Technical data



	Customer value	Mivit®	Mivit® GD
Value Line	Heavy product load	■	■
	Energy efficiency	■	■
	Streamlined operation	■	■
	Product visibility	■	■
	Installation/ Serviceability	■	■
	Floor space productivity	■	■
	Cabinet aesthetics	■	■

Mivit® 52 - GD . 375 M2 - 1 L

Name of product line
Bottom shelf depth: 5 – 500 mm
Front height: 2 – 200 mm
Glass door
Cabinet length: 3 750 mm
Temperature class: M2*
Revision index: 1
Cabinet height: L = ~ 2 220 mm

*Cabinet design according to EN ISO 23953 at climate class 3

Narrow displayer

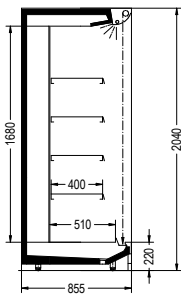

Mivit® 52.M2-1

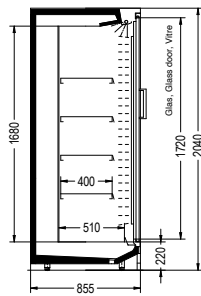

Mivit® 52.GD.M2-1

Volume seller

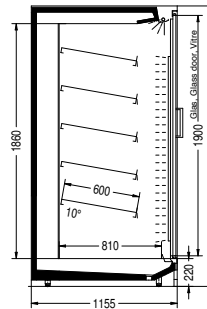

Mivit® 82.GD.M2-1 L

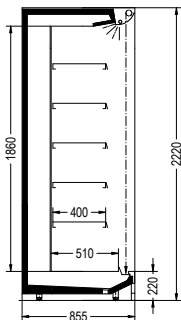

Mivit® 52.M2-1 L

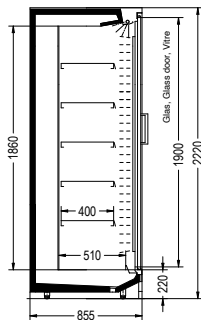

Mivit® 52.GD.M2-1 L



Small Store



Discounter

E6 Mivit® & E6 Mivit® GD	Unit	Mivit®		Mivit® GD	
		52	52	82	
Internal height STD-height	mm	1680	1680	-	
Internal height L-height	mm	1860	1860	1860	
Bottom shelf depth	mm	510	510	810	
Shelf depth (min. / standard / max.)	mm	350 / 400 / 400	350 / 400 / 400	450 / 600 / 600	
Shelves STD-height (min. / standard / max.)	rows	3 / 4 / 7	3 / 4 / 7	-	
Shelves L-height (min. / standard / max.)	rows	3 / 5 / 8	3 / 5 / 8	3 / 5 / 8	
Load per module	kg / 125cm	560	560	850	
Module length without endwalls (40 mm each)	125	✓	✓	-	
	188	✓	✓	-	
	250	✓	✓	✓	
	375	✓	✓	✓	
Temperature class M2 / Storage temp. 0/+2 °C		✓	✓	✓	
Energy label*		E	C	D	

* Label might change depending on configuration

E6 Mirado® FV

Ultrafresh Line

Open semi-vertical multideck with optimized design for ultrafresh goods

Space optimizer / Operation optimizer



Benefits at a glance

- Maximum display opening by slim canopy
- Ergonomic height
- Special shelving for F&V presentation
- Enhanced visibility in the store

Standard configuration

- Stepped display shelves with 50 mm wire fence
- Sheet metal design for rear wall
- Integrated bumper, integral bumper and single-piece front kickplate
- Energy efficient EC fans
- Bottom evaporator (F-gas) / Mirado® 63.M1-2 with backwall evaporator (F-gas)
- Multiplex kit

Customization

- Manual night blinds
- LED selection for canopy lighting, shelf lighting and front shelf lighting
- Stainless steel interior
- Large selection of shelves, price rails and front stoppers
- Plinth bumper for increased protection
- Reinforced (additional) front bumper
- Bottom evaporator (CO₂) / Mirado® 63.M1-2 with backwall evaporator (CO₂)
- Stepped display shelves with brackets (up to 27°) and reinforced scanner price rails

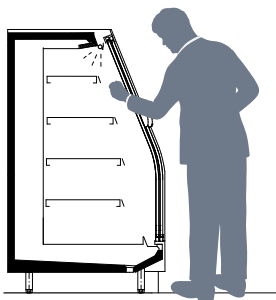

The semi-vertical size provides ergonomic height and customer contact on eye level



The maximum display opening and the stepped display shelves offer the best presentation of your products



Display shelves with brackets (up to 27°) and reinforced scanner price rails for best product presentation

Technical data

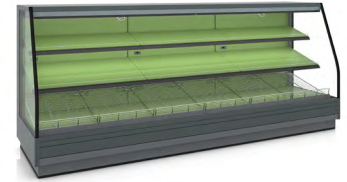

	Customer value	Mirado® FV
Ultrafresh Line	Heavy product load	■ ■ ■
	Energy efficiency	■ ■ ■ ■ ■
	Streamlined operation	■ ■ ■ ■ ■ ■ ■
	Product visibility	■ ■ ■ ■ ■ ■ ■ ■ ■
	Installation/Serviceability	■ ■ ■ ■ ■ ■ ■ ■ ■
	Floor space productivity	■ ■ ■ ■ ■ ■ ■ ■ ■ ■ ■
	Cabinet aesthetics	■ ■ ■ ■ ■ ■ ■ ■ ■ ■ ■ ■ ■

Mirado®	84	-	250	-	S3	-	1	-	FV
Name of product line									
Bottom shelf depth: 8 – 800 mm									
Front height: 4 – 400 mm									
Cabinet length: ~ 2 500 mm									
Temperature class: S3									
Revision index: 1									
Fruit and vegetables									

Space optimizer

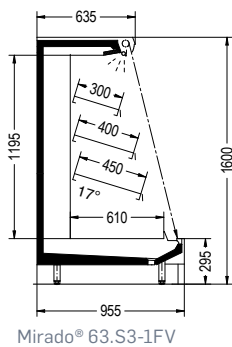

Operation optimizer

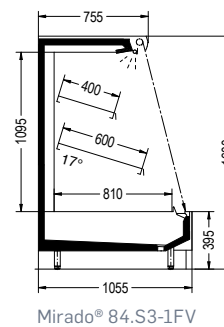
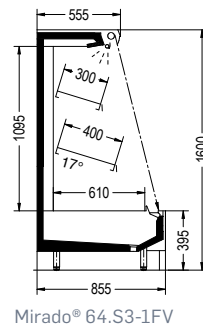

E6 Mirado® FV	Unit	63	64	84
Internal height	mm	1195	1095	1095
Bottom shelf depth	mm	610	610	810
Shelf depth (min. / standard / max.)	mm	300 / - / 500	300 / - / 500	300 / - / 600
Shelves (min. / standard / max.)	rows	1 / 3 / 4	1 / 2 / 4	1 / 2 / 4
Module length without endwalls (40 mm each)	125	✓	✓	✓
	188	✓	✓	✓
	250	✓	✓	✓
	375	✓	✓	✓
Temperature class S3* / Storage temp. +5/+12 °C		✓	✓	✓



* Cabinets with storage temperature above +10 °C are not within the scope of *Commission Delegated Regulation (EU) 2019/2018 supplementing Regulation (EU) 2017/1369 with regard to energy labelling of refrigerating appliances with a direct sales function*

E6 Methos FV & E6 Mendos[®] FV

Ultrafresh Line

Open multideck with optimized design for ultrafresh goods

Narrow merchandiser / Space optimizer



Benefits at a glance

- Highest footprint productivity
- Large selection of configurations
- Easy access of evaporator and fans
- Special shelving for F&V presentation

Standard configuration

- Display shelves with 50mm wire fence
- Sheet metal design for rear wall for Methos FV
- Integrated bumper and kickplate
- Energy efficient EC fans
- Bottom evaporator (F-gas)
- Multiplex kit

Customization

- Display shelves with brackets (up to 27°) and reinforced scanner price rails
- Night blind options:
 - Motorized (30-50% less energy consumption)
 - Manual night blind option (30% less energy consumption)
- Horizontal LED lighting for canopy, shelf and front shelf
- Dimming box for Premium LED lighting
- Stainless steel interior
- Large selection of shelves, price rails and front stoppers
- Reinforced (additional) front bumper for E6 Methos FV
- Bottom evaporator (CO₂)



The installed bottom evaporator provides the best floor space productivity among all multideck cabinets for your turnover



Display shelves with brackets (up to 27°) and reinforced scanner price rails for best product presentation



The optimized small footprint design makes the Methos FV perfect for installations in smaller markets and spaces

Technical data



	Customer value	Methos FV	Mendos® FV
Ultrafresh Line	Heavy product load	■	■
	Energy efficiency	■	■
	Streamlined operation	■	■
	Product visibility	■	■
	Installation/Serviceability	■	■
	Floor space productivity	■	■
	Cabinet aesthetics	■	■

Methos	63	250	S3	1	FV	L
Name of product line						
Bottom shelf depth: ~ 600 mm						
Front height: ~ 300 mm						
Cabinet length: ~ 2 500 mm						
Temperature class: S3						
Revision index: 1						
Fruit and vegetables						
Cabinet height: L= ~ 2 220 mm						

Narrow merchandiser

Space optimizer

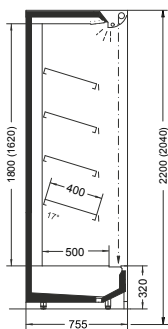

Methos 53.S3-1 FV L



Small Store

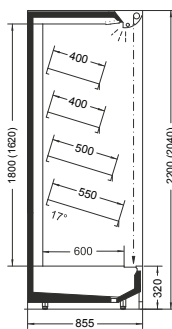

Methos 63.S3-1 FV L



Supermarket

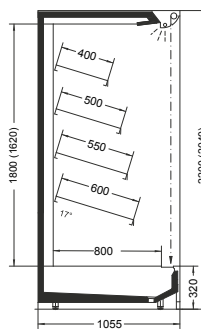

Methos 83.S3-1 FV L



Hypermarket

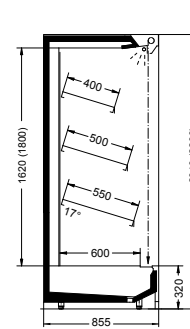

Mendos® 63.S3-1 FV (L)

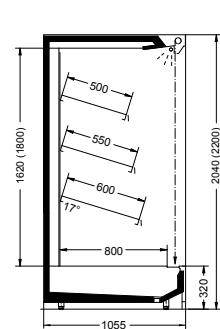

Mendos® 83.S3-1 FV (L)

E6 Methos FV & E6 Mendos® FV	Unit	53**	63	83
Internal height STD-height	mm	1620	1620	1620
Internal height L-height	mm	1800	1800	1800
Bottom shelf depth	mm	500	600	800
Shelf depth (min. / standard / max.)	mm	300 / - / 500	300 / - / 600	300 / - / 600
Shelves STD-height (min. / standard / max.)	rows	2 / 3 / 6	2 / 3 / 6	2 / 3 / 6
Shelves L-height (min. / standard / max.)	rows	2 / 4 / 7	2 / 4 / 7	2 / 4 / 7
Load per module	kg / 125cm	510	665	820
Module length without endwalls (40 mm each)	125	✓	✓	✓
	188	✓	✓	✓
	250	✓	✓	✓
	375	✓	✓	✓
Temperature class S3* / Storage temp. +5/+12 °C		✓	✓	✓



* Cabinets with storage temperature above +10 °C are not within the scope of "Commission Delegated Regulation (EU) 2019/2018 supplementing Regulation (EU) 2017/1369 with regard to energy labelling of refrigerating appliances with a direct sales function" | ** Available just for E6 Methos FV

E6 Monaxis® FV & E6 Monaxis®-R FV

Open multideck with optimized design for ultrafresh goods

Ultrafresh Line

Operation optimizer / Volume seller



Benefits at a glance

- Lowest life cycle costs
- Best maintenance conditions
- Hygienic interior design
- Special shelving for F&V presentation

Standard configuration

- Low front height (220mm, 295mm)
- Display shelves with 50mm wire fence
- Sheet metal design for rear wall
- Integrated front bumper and kickplate
- Energy efficient EC fans
- Backwall evaporator (F-gas)
- Multiplex kit

Customization

- Display shelves with brackets (up to 27°) and reinforced scanner price rails
- Night blind options:
 - Motorized (30-50 % less energy consumption)
 - Motorized with efficient cover (40-70 % less energy consumption)
- Horizontal LED lighting for canopy, shelf and front shelf
- Dimming box for Premium LED lighting
- Front glazing
- Stainless steel interior
- Large selection of shelves, price rails and front stoppers
- Reinforced (additional) front bumper and endwall
- Plinth front bumper and endwall (for front 295 mm)
- Backwall evaporator (CO₂)



E6 Monaxis®-R 80 FV with fruit and vegetables trolleys allow fast stocking and easy cleaning



Display shelves with brackets (up to 27°) and reinforced scanner price rails for best product presentation



Easy to clean bottom area by backwall evaporator with simple access of the expansion valve

Technical data



Customer value	Monaxis® FV	Monaxis®-R FV
Heavy product load	■	■
Energy efficiency	■	■
Streamlined operation	■	■
Product visibility	■	■
Installation/Serviceability	■	■
Floor space productivity	■	■
Cabinet aesthetics	■	■

Ultrafresh Line

Monaxis® **63** - **375** - **S3** **1** - **FV** **L**

Name of product line

Bottom shelf depth: ~ 600 mm

Front height: ~ 300 mm

Cabinet length: 3 750 mm

Temperature class: S3

Revision index: 1

Fruit and vegetables

Cabinet height: L ~ 2 220 mm

Operation optimizer

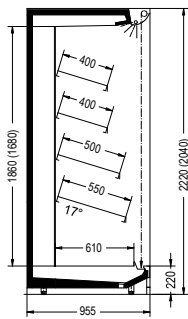

Monaxis® 62.S3-1 FV L

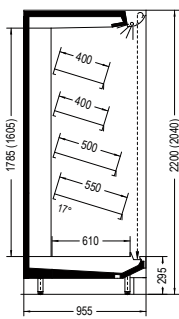

Monaxis® 63.S3-1FV L

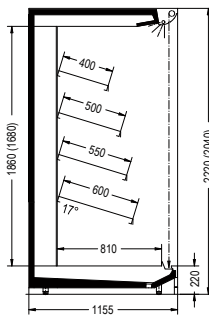

Monaxis® 82.S3-1 FV L

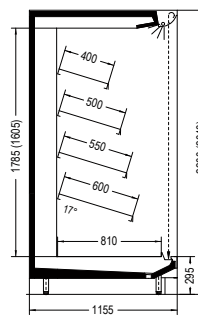

Monaxis® 83.S3-1FV L

Volume seller

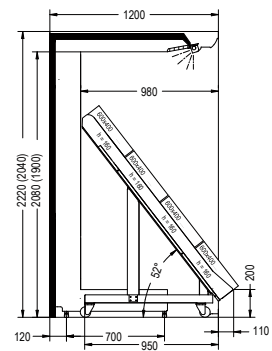

Monaxis®-R 80.S3-1FV L



E6 Monaxis® FV & E6 Monaxis®-R FV	Unit	62	63	82	83	R-80
Internal height STD-height	mm	1680	1605	1680	1605	1900
Internal height L-height	mm	1860	1785	1860	1785	2080
Bottom shelf depth	mm	610	610	810	810	950*
Shelf depth (min. / standard / max.)	mm	300 / - / 600	300 / - / 600	300 / - / 600	300 / - / 600	-
Shelves STD-height (min. / standard / max.)	rows	2 / 3 / 6	2 / 3 / 6	2 / 3 / 6	2 / 3 / 6	Roll-in trolley
Shelves L-height (min. / standard / max.)	rows	2 / 4 / 7	2 / 4 / 7	2 / 4 / 7	2 / 4 / 7	Roll-in trolley
Load per module	kg / 125cm	690	690	850	850	-
Module length without endwalls (40 mm each)	125	✓	✓	✓	✓	✓
	188	✓	✓	✓	✓	✓
	250	✓	✓	✓	✓	✓
	375	✓	✓	✓	✓	✓
Temperature class S3** / Storage temp. +5/+12 °C		✓	✓	✓	✓	✓



* Bottom depth | ** Cabinets with storage temperature above +10 °C are not within the scope of "Commission Delegated Regulation (EU) 2019/2018 supplementing Regulation (EU) 2017/1369 with regard to energy labelling of refrigerating appliances with a direct sales function"

E6 Program Features

All 60 bar CO₂ evaporators operate with 90 bar expansion valve and 90 bar liquid line

Benefits

- Modern design concept
- Increased display area
- Flexibility in merchandising
- EN ISO 23953 classification
- Energy & service efficiency
- Reduced lifecycle cost

Approx. 11%
larger glass area

25 mm shelf
spacing

Numbered shelving

Price rail located
close to products;
stopper included

Improved
lighting



BREEZtec®

Carrier's Next Generation Air Circulation System

Energy & economical efficiency

- Reduction of energy consumption from 30 to 45% compared to conventional EC fans¹
- Energy cost savings per cabinet result from 50 to 70 Euro per year²
- Designed for a high service durability

Operation & noise emissions

- Provides homogeneous and highly efficient temperature distribution by combining Carrier Temperature Equalizer System (TES) and EC fan motors
- Reduced sound pressure level by up to -4dBA
- Better noise quality by smooth spectrum with lower tonal content

Application

The new BREEZtec® air circulation system is optimized for all remote E6 Multidecks and E6 Semi-Verticals with back evaporator design.

Latest EC fan motor technology with new Carrier patented fan housing and fan blade design for improved energy efficiency and reduced noise emission.

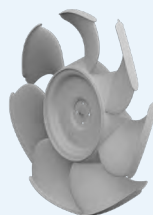

Remote multideck with back evaporator design showing the position of the new Carrier fan technology and the optimized air circulation inside the cabinet for a better homogeneous product storage temperature.



Premium Power LED for Canopy

Temperature Equalizer System + dual air curtain



Modern clean design

Optimized air management

Minimum distance bottom shelf to lowest shelf level: 295mm

Higher evaporating temperature

Cabinets fulfill temperature class M0, M1 or M2 according to EN ISO 23953

Insulated all-glass doors (Frameless with small print or fully Transparent)



E6 Glass Door Program Multidecks

To increase display area and maximize the visibility of the products with the optimized energy efficiency



Swing Fully Transparent Door with Transparent Gap Cover

Best product visibility

Swing Fully Transparent Door with Solid Mullion



High product visibility & high energy efficiency

E6 Multideck & E6 Semi-Vertical	Glass Door Type					
	Swing All-glass Frameless Door with small Dark grey Print	Swing All-glass Frameless Door with small Light grey Print	Swing Fully Transparent Door	Swing Fully Transparent Door with Anti-reflex coating	Fully Transparent 400 mm Door	Sliding Fully Transparent Door
Methos GD	✓		✓	✓	✓	
MonaxEco® 63/73/83	✓		✓	✓		
MonaxEco® 62/82			✓	✓		
Maress® GD			✓	✓		
MenEco®		✓				
Mivit® GD*		✓	✓			
Optimer® L GD (remote)	✓		✓	✓		
Morea® GS						✓
Mirado® GS						✓

All types of Transparent Doors are available with Solid Mullion and Transparent Gap Cover

*Available with Solid Mullion only

Glass Door Type	Swing All-glass Frameless Door with small Dark grey Print	Swing All-glass Frameless Door with small Light grey Print	Swing Fully Transparent Door	Swing Fully Transparent Door with Anti-reflex coating	Fully Transparent 400 mm Door
Gas Inside	Argon	Argon	Argon	Argon	Argon
Ug value [W/m²K]*	1,1	1,1	1,1	<1,8	1,1
Light Transmittance [%]	80	80	80	92	80
Outdoor reflectance [%]	12	12	12	4	12
Multidecks application	ALL except MenEco®, Mivit® GD	MenEco®, Mivit® GD	ALL except MenEco®	ALL except MenEco®, Mivit® GD	Methos GD

*The lower the Ug value, the lower the energy loss due to heat transmission through the glass

Door handle options



MonaxEco®, Maress® GD, Mivit® GD

- Light grey
- Transparent
- Dark grey



Methos GD

- Dark grey
- Transparent



MenEco®

- Light grey

Best energy efficiency



Swing All-glass Frameless Door with small Dark grey Print with Solid Mullion

Best energy efficiency



Swing All-glass Frameless Door with small Light grey Print with Solid Mullion

E6 Light Program Multidecks & Semi-Verticals

Glass Door Multidecks



Canopy lighting

- Premium Power LED
- Premium LED
- Smart LED

Vertical lighting

- Premium LED (Solid mullion)
- Premium SLIM LED * (Integrated in transparent gap cover with no glare, no dots, no additional canopy needed)
- Smart LED

*Available for Methos GD, MonaxEco®, Maress® GD with transparent doors and Transparent gap cover

Canopy lighting

- Premium Power LED
- Premium LED
- Smart LED

Shelf lighting

- Premium Front Shelf LED
- Premium LED
- Smart LED

Available colors Premium LED*:

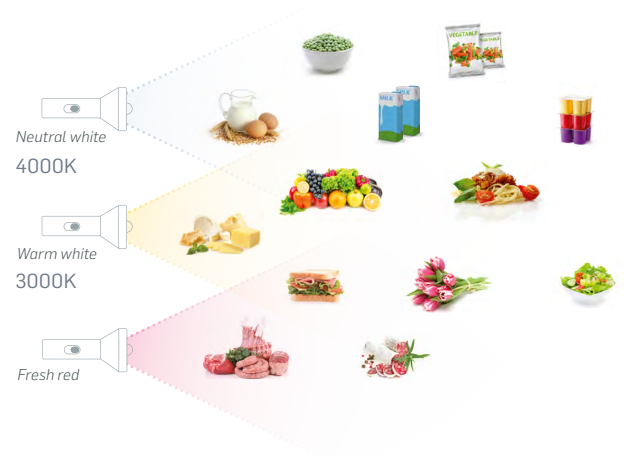

Possible Light Combinations	PREMIUM LED					SMART LED		
	Premium Vertical LED *	Premium Canopy LED	Premium Power Canopy LED	Premium Front Shelf LED	Premium Shelf LED	Smart Vertical LED **	Smart Canopy LED	Smart Shelf LED
PREMIUM LED								
Premium Vertical LED *	✓	✓	✓	-	-	-	-	-
Premium Canopy LED	✓	✓	-	✓	✓	-	-	-
Premium Power Canopy LED	✓	-	✓	✓	✓	-	-	-
Premium Front Shelf LED	-	✓	✓	✓	-	-	-	-
Premium Shelf LED	-	✓	✓	-	✓	-	-	-
SMART LED								
Smart Vertical LED **	-	-	-	-	-	✓	✓	-
Smart Canopy LED	-	-	-	-	-	✓	✓	✓
Smart Shelf LED	-	-	-	-	-	-	✓	✓

* only for closed multidecks ** only for closed multidecks with solid mullion

* LED mix between Premium range and Smart LED range not possible

Open Multidecks



Canopy lighting

- Premium Power LED
- Premium LED
- Smart LED

Shelf lighting

- Premium Front Shelf LED
- Premium LED
- Smart LED

Available colors Smart LED*:



Semi-Verticals (open / glass door)

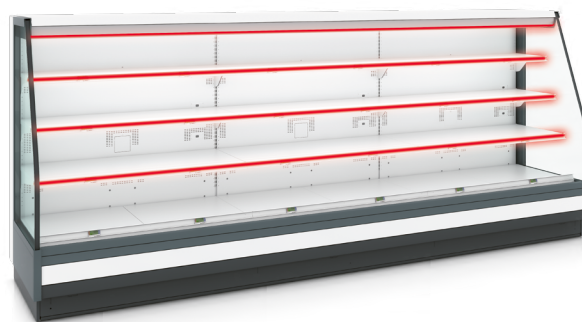

Canopy lighting

- Premium LED
- Smart LED

Shelf lighting

- Premium Front Shelf LED
- Premium LED
- Smart LED

Premium LED Features

- Best possible product illumination thanks to a special optic
- High color performance CRI 94
- Very long lifetime 94 000 hours L80 B10
- Robust aluminium housing
- Full color range of all options

Smart LED Features

- Efficient LED lamp with bright illumination
- Plastic housing
- Neutral white for all products
- Best value for price







Dimming box Features

- To adjust the light brightness individually per cabinet without color drift in order to reduce food waste
- Available for all Premium LED colors for E6 Monaxis® (GD), E6 Maress® (GD), E6 Methos (GD)





E6 Color Concept Multidecks

Plastic parts

Deep Black (FA 9005)	
Anthracite (FA 7016)	
Grey (FA 0502)	
Nimbus Grey (FA 0633)	
Stratus Grey (FA 0632)	
Cirrus Grey (FA 0631)	

Grid & wire

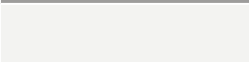
Deep Black (FA 9005)	
White Aluminium (FA 9006)	
Signal White (FA 0605)	



Front	Standard color	Optional color
Price rails	Signal White	Deep Black, White Aluminium
Return air grille	Stratus Grey, Signal White	See Carrier Colors Guide
Front bumper	Stratus Grey	Grey, Cirrus Grey, Deep Black, Anthracite
Plinth panel	Nimbus Grey	Grey, Cirrus Grey, Stratus Grey, Deep Black, Anthracite
Kickplate	Nimbus Grey	See Carrier Colors Guide
Cover front	Stratus Grey	See Carrier Colors Guide



Exterior	Standard color	Optional color
Canopy panel	Nimbus grey	See Carrier Colors Guide
Endwall, external		
Endwall cover base section	Stratus Grey	See Carrier Colors Guide

Interior	Standard color	Optional color
Display shelves	Signal White	See Carrier Colors Guide
Air baffle plate		
Bottom deck		
Ceiling panelling	Stratus Grey	Anthracite
Endwall, internal (panorama and mirrored)		

Endwalls

E6 Semi-Verticals & E6 Multidecks

Cabinets	Endwall Type				Dividing Wall Type		
	Rectangular		Contoured		Rectangular		
	Panorama	Internally mirrored (on one side)	Panorama	Mirrored on both sides	Panorama	Internally mirrored (on both sides)	Non-glazed/mirrored
Methos / Methos FV	✓	✓	-	-	✓	✓	-
Monaxis® / MonaxEco® / Monaxis® FV	✓	✓	-	-	✓	✓	-
Maress® / Maress® GD	✓	✓	-	-	✓	✓	-
Monaxis®-R	✓	✓	-	-	-	-	✓
Monaxis®-R FV	✓	✓	-	-	-	-	✓
Mendos® / MenEco®	✓	✓	-	-	✓	✓	-
Mivit® / Mivit® GD	✓	✓	-	-	✓	✓	-
Mirado® / Mirado® GS / Mirado® FV	-	✓	✓	✓	-	-	✓
Morea® / Morea® GS	-	✓	✓	✓	-	-	✓

FV = Fruit & Vegetables

Examples per product family:

Prime Line

E6 Mirado® 63 GS



Panorama Mirrored on both sides Internally mirrored

E6 Morea® 84 GS



Panorama Mirrored on both sides Internally mirrored

E6 Methos 53-GD



Panorama Internally mirrored

E6 MonaxEco® 63



Panorama Internally mirrored

E6 Maress® 82-GD

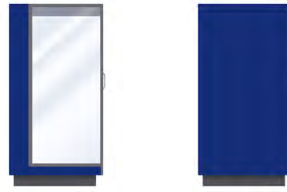

Panorama Internally mirrored

E6 Mivit® 52-GD



Panorama Internally mirrored

E6 MenEco® EU



Panorama Internally mirrored

Bumpers

E6 Semi-Verticals & E6 Multidecks

Examples per product family:

E6 Mirado® / Mirado® GS
E6 Morea® / Morea® GS
E6 Mirado® FV

E6 Monaxis® / MonaxEco®
E6 Monaxis® FV



Front bumper (standard) and integral bumper (standard)*



Plinth bumper for the front and endwall*



Front bumper (standard)



Front bumper for endwall (additional)

E6 Methos / Methos GD
E6 Methos FV



Front bumper (standard)*



Front bumper (additional)*

E6 Maress® / Maress® GD
E6 Mivit® / Mivit® GD



Front bumper (standard)

E6 Monaxis®-R



Front bumper (standard)

E6 Mendos® / MenEco®



Front bumper (standard)*

***White front parts**
 Paintable metal sheet.
 Customization possible according to Carrier's Powder paint selection guide



Bumpers	E6 Mirado®	E6 Mirado®-GS	E6 Morea®	E6 Morea®-GS	E6 Methos	E6 Methos GD	E6 Monaxis®	E6 MonaxEco®	E6 Maress®	E6 Maress® GD	E6 Monaxis®-R	E6 Maress®-R	E6 Mendos®	E6 MenEco®	E6 Mivit®	E6 Mivit® GD	E6 Mirado® FV	E6 Methos FV	E6 Monaxis® FV
Bumpers (standard)																			
Front bumper (stratus grey)	●	●	●	●	●	●	●	●	●	●	●	●	●	●	●	●	●	●	●
Integral bumper (nimbus grey)	●	●	●	●													●		
Bumpers (optional) Front bumpers additional																			
Front bumper	○	○	●	●	●	●	●	●									○	●	●
Front bumper, Form A					●	●							●	●				●	
Endwall bumpers																			
Bumper for endwall with corner piece							○	○	●	●	●	●			●	●			●
Plinth bumpers																			
Plinth bumper	○	○	●	●			●	●									●		●
Plinth bumper for endwall with corner piece	○	○	●	●			●	●									●		●

● Available ○ Available for specific cabinets or length

Accessories

E6 Semi-Verticals & E6 Multidecks

Price Marking

Accessories	E6 Mirado®	E6 Mirado® GS	E6 Morea®	E6 Morea® GS	E6 Methos	E6 Methos GD	E6 Monaxis®	E6 MonaxEco®	E6 Maress®	E6 Maress® GD	E6 Monaxis®-R	E6 Mendos®	E6 MenEco®	E6 Mivit®	E6 Mivit® GD	E6 Mirado® FV	E6 Methos FV	E6 Monaxis® FV	
Scanner pricing rails																			
Scanner pricing rail 40 mm	•	•	•	•	•	•	•	•	•	•	•	•	•	•	•	•	•	•	•
Scanner pricing rail 40 mm (27°)																			
Scanner pricing rail 60 mm	•	•	•	•	•	•	•	•	•	•	•	•	•	•	•	•	•	•	•
Scanner pricing rail 60 mm (27°)																•	•	•	•
Scanner pricing rail, 40mm with product stop	•	•	•	•	•	•	•	•	•	•	•	•	•	•	•				
Pricing rail holders																			
Pricing rail holder, Form R (ESL)	•	•	•	•	•	•	•	•	•	•	•	○	○	•	•				
Pricing rail holder, ALU, 58 mm									•	•									
Holder for pricing tags for display shelf	•	•	•	•	•	•	•	•	•	•	•	•	•	•	•	•	•	•	•
Holder for price tickets	•	•	•	•	•	•	•	•	•	•	•	•	•	•	•	•	•	•	•
Holder price rail, flush, Form K	•	•	•	•	•	•	•	•	•	•	•	•	•	•	•	•	•	•	•
Holder price rail, upraised, Form K	•	•	•	•	•	•	•	•	•	•	•	•	•	•	•	•	•	•	•
Holder price rail, Form K							•	○											•
Holder for pricing tags, triple, for display shelf	•	•	•	•	•	•	•	•	•	•	•	•	•	•	•	•	•	•	•
Scanner pricing rail 58 mm with holder									•	•									
Price marking, other																			
Pricing rail for electronic marking (ESL)					•	•	•	•	•	•	•			•	•				
Pricing rail for electronic marking, Form F (ESL)	•	•	•	•	•	•	•	•				•	•	•	•	•	•	•	•
Universal price holder for shelf, Form F (ESL)	•	•	•	•	•	•	•	•				•	•	•	•	•	•	•	•
Bracket for pricing rail									•	•									
Cabinet front scanner pricing rails																			
Pricing rail for bottom shelf 40 mm					•	•					•	•	•						•
Pricing rail for bottom shelf 52 mm	•	•	•	•	•	•	•	•	•	•	•	•	•	•	•	•	•	•	•
Pricing rail for bottom shelf 60 mm	•	•	•	•	•	•	•	○	•	•	•	•	•	•	•	•	•	•	•
Cabinet front pricing rail holders																			
Holder Price rail elec. mark., base shelf, Form F (ESL)	•	•	•	•	•	•	•	○				•	•	•	•	•	•	•	•
Holder Price rail elec. mark., base shelf, Form A (ESL)	○	○	•	•	•	•						•	•			○	•		
Universal price rail holder, base shelf, Form F	○	○	•	•	•	•						•	•			○	•		
Holder price rail bottom deck											•								

• Available ○ Available except special dimensions

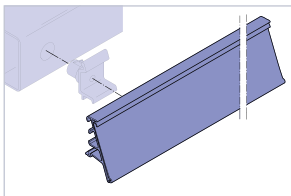

Scanner pricing rail 40 mm

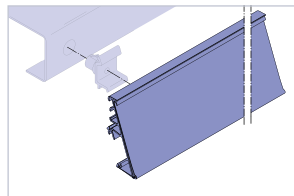

Scanner pricing rail 60 mm

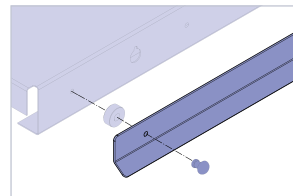

Pricing rail holder, Form R (ESL), Fig. 1

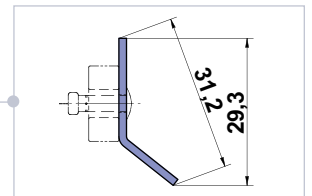

Pricing rail holder, Form R (ESL), Fig. 2

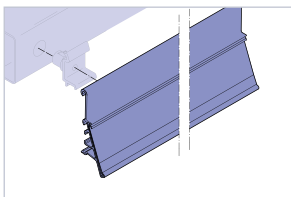

Scanner pricing rail, 40 mm, with product stop

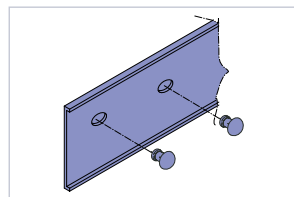

Pricing rail holder, ALU, 58 mm

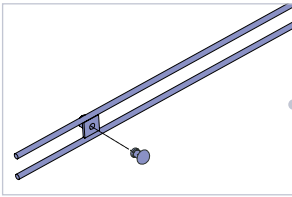

Holder for pricing tags for display shelf, Fig. 1

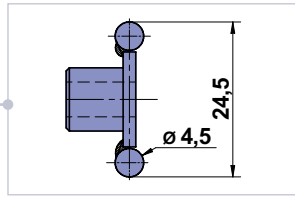

Holder for pricing tags for display shelf, Fig. 2

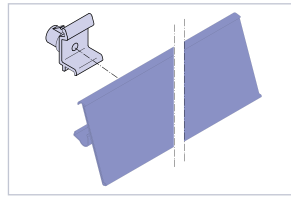

Holder for price tickets

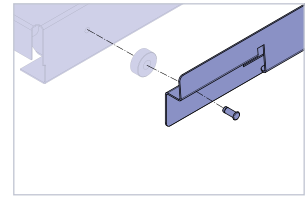

Holder price rail, flush, Form K

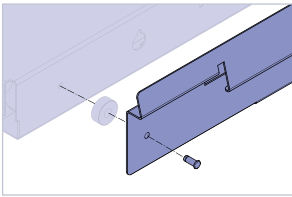

Holder price rail, upraised, Form K

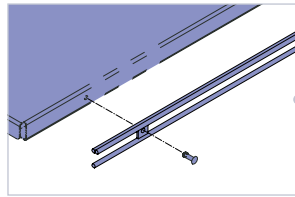

Holder for pricing tags, triple, for display shelf, Fig. 1

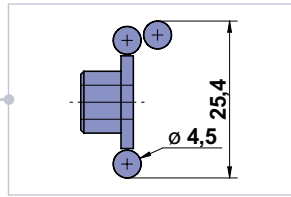

Holder for pricing tags, triple, for display shelf, Fig. 2

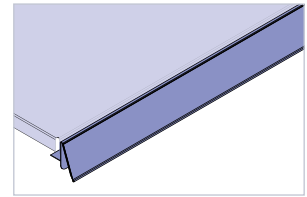

Scanner pricing rail 58 mm with holder

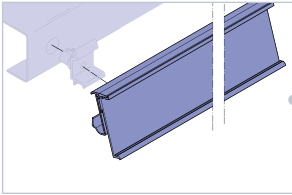

Pricing rail for electronic marking (ESL), Fig. 1

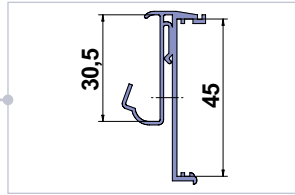

Pricing rail for electronic marking (ESL), Fig. 2

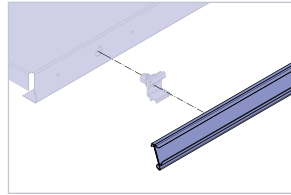

Pricing rail for electronic marking, Form F (ESL), Fig. 1

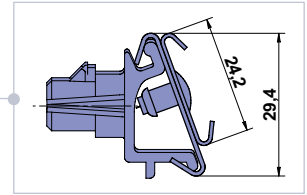

Pricing rail for electronic marking, Form F (ESL), Fig. 2

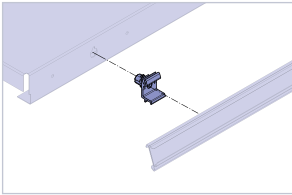

Universal price holder for shelf, Form F (ESL)

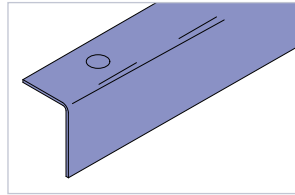

Bracket for pricing rail

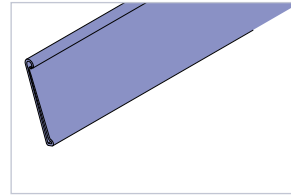

Pricing rail for bottom shelf, 40, 52, 60 mm

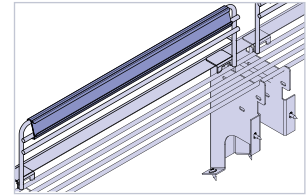

Holder Price rail elec. mark., base shelf, Form F (ESL)

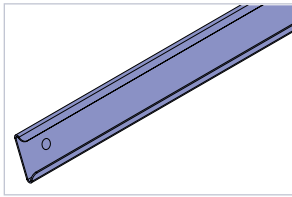

Holder Price rail elec. mark., base shelf, Form A (ESL)

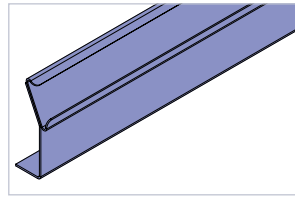

Universal price rail holder, base shelf, Form F

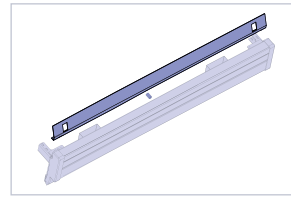

Holder price rail bottom deck

Appearance and measurement may slightly differ



Accessories

E6 Semi-Verticals & E6 Multidecks

Display Shelves & Mirrors

Accessories	E6 Mirado®	E6 Mirado® GS	E6 Morea®	E6 Morea® GS	E6 Methos	E6 Methos GD	E6 Monaxis®	E6 MonaxEco®	E6 Maress®	E6 Maress® GD	E6 Monaxis®-R	E6 Mendos®	E6 MenEco®	E6 Mivit®	E6 Mivit® GD	E6 Mirado® FV	E6 Methos FV	E6 Monaxis® FV	E6 Mendos® FV	
Mirrors					○	○	○	○	○	○	○	○	○	○	○	○	○	○	○	○
Display shelves	○	○	○	○	○	○	○	○	○	○	○	○	○	○	○	●	○	●	○	
Display shelves with single side coating					○	○	○	○	○	○	○	○	○	○	○		○		○	
Display shelves with CrNi	○	○	○	○	○	○	○	○	○	○	○	○	○	○	○	●	●	●	●	
Slim line display shelves	○	○	○	○	○	○	○	○	○	○	○	○	○	○	○	●	●	●	●	
Slim line display shelves CrNi	○	○	○	○	○	○	○	○	○	○	○	○	○	○	○	●	●	●	●	
Beverages shelves					○	○	○	○	○	○	○	○	○	○	○					
Heavy duty shelves / brackets					○	○	○	○	○	○	○	○	○	○	○					
Display shelves with air control											○									
Display shelf end cover	○	○	○	○	○	○	○	○	○	○	○	○	○	○	○	○	○	○	○	
Wire divider	○	○	○		○	○	○	○	●	●	○	○	○	○	○	○	○	○	○	
Wire fences	○	○	○	○	●	●	●	●	●	●	○	●	●	●	○	○	○	○	○	
Glass fences	○	○	○	○	●	●	●	●	●	●	●	●	●	●	○	○	○	○	○	

● Available ○ Available except special dimensions



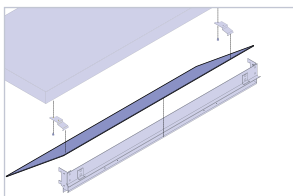

Mirror, 330, 450 mm

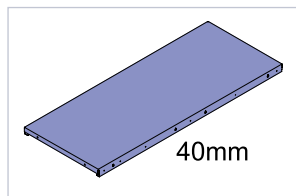

Display shelf / single side coating / CrNi, 300, 350, 400, 450, 500, 550, 600 mm

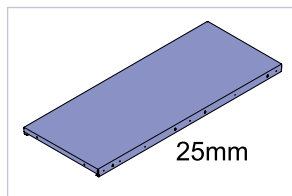

Slim Line display shelf / CrNi, 300, 350, 400, 450, 500, 550, 600 mm

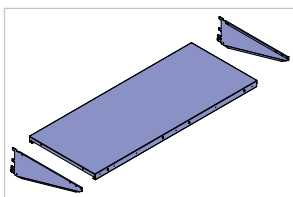

Heavy duty shelf, 350, 400 mm / Heavy duty brackets

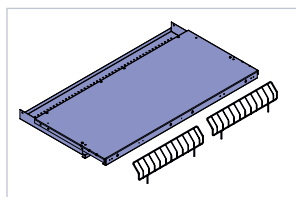

Display shelf with air control, 650 mm

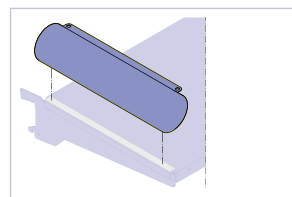

Display shelf cover 350, 400, 450, 500, 550, 600 mm

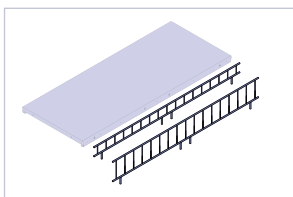

Wire fence 50, 100 mm

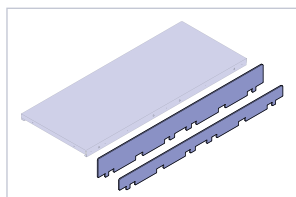

Glass fence 30, 50, 70, 100 mm / Glass fence slim line 50, 70, 100 mm

Appearance and measurement may slightly differ





SPEISEEIS

SPEISEEIS

Vertical Freezers

Vertical Freezers

Product Overview E6 Vertical Freezers

Narrow merchandiser

Maximum product facing in small spaces

Space optimizer

Maximum floor space productivity optimized for back-to-back installation

Vertical Freezers

Prime Line



E6 Velando® 53



E6 Velando® AF



E6 Velando® QL AA CE 191

Value Line



E6 Velando® CS*



E6 Velando® SG 63

Prime Line: Energy efficient design with a wide range of module lengths, options and accessories

Value Line: Focus on essential features with limited range of module lengths, options and accessories

Flexible merchandiser

Inlcudes smart features



E6 Virando® 63



E6 Velando® QL AA CE 235

* For product information please see Compact Line brochure

E6 Virando® 63

Prime Line

Semi-vertical freezer for the new center of your market



Benefits at a glance

- Large loading volume at low height
- Ideally suited for market center installations
- Perfectly combinable with chiller semi-verticals from E6 Mirado® range

Standard configuration

- Black Anti-Fog (AF) all-glass doors
- Black ergonomic door handles
- Wire shelves with front to back rods
- Vertical LED lighting for mullions
- Integrated bumper and kickplate
- Energy efficient EC fans
- Bottom evaporator (F-gas)
- Multiplex kit

Customization

- Horizontal LED lighting for canopy
- Large selection of display baskets, wire shelves, bottom racks and wire dividers
- Plinth front bumper and endwalls
- Bottom evaporator (CO₂)



Perfectly combinable with semi-vertical chiller E6 Mirado® to present a large range of products in small place



Semi-vertical low height of only 1,60m enhances vision and display in your market and improves the contact between customers



Wide range of accessories with wire shelves, display baskets and telescopic display baskets for easy loading

Technical data

	Customer value	Virando® 63
Prime Line	Heavy product load	■ ■ ■ ■
	Energy efficiency	■ ■ ■ ■ ■ ■ ■ ■ ■ ■
	Streamlined operation	■ ■ ■ ■ ■ ■ ■ ■ ■ ■
	Product visibility	■ ■ ■ ■ ■ ■ ■ ■ ■ ■
	Installation/ Serviceability	■ ■ ■ ■ ■ ■ ■ ■ ■ ■
	Floor space productivity	■ ■ ■ ■ ■ ■ ■ ■ ■ ■
	Cabinet aesthetics	■ ■ ■ ■ ■ ■ ■ ■ ■ ■



Virando® 63 390 L1 - 1

Name of product line
 Bottom shelf depth: 6 – 600 mm
 Front height: 3 – 300 mm
 Cabinet length: ~ 3 900 mm
 Temperature class: L1*
 Revision index: 1

*Cabinet design according to EN ISO 23953 at climate class 3

Flexible merchandiser

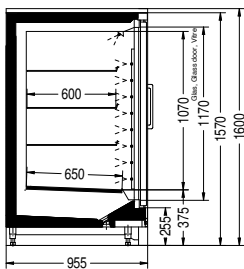

Virando® 63.L1-1



Supermarket



Hypermarket



Concept study:

Freezer section with E6 Velando® AF, E6 Virando® 63 & E6 Irios® GL with wood cladding option

E6 Virando®	Unit	63.L1-1
Max. height inside	mm	1070
Bottom shelf depth	mm	650
Shelf depth	mm	500 / 600 / 600
Shelves	rows	2 / 3 / 5
Module length (door) without endwalls (50 mm each)	2D-156	✓
	3D-235	✓
	4D-313	✓
	5D-390	✓
Temperature class L1 / Storage temp. -22/-24 °C		✓
Energy Label*		E

* Label might change depending on configuration

E6 Velando[®] 53

Prime Line

Narrow vertical freezer with outstanding footprint productivity for limited space

Narrow merchandiser



Benefits at a glance

- Large loading volume for a narrow footprint
- High footprint sales productivity
- Excellent product visibility

Standard configuration

- Total depth of only 765 mm
- Anti-Fog (AF) doors with aluminium frame
- Ergonomic door handles
- Slim brackets with 25 mm shelf spacing and numbering
- Vertical LED lighting
- Bottom evaporator (F-gas)
- Energy efficient EC fans

Customization

- Panorama endwalls
- Bottom display baskets
- External bumper for increased protection
- Bottom evaporator (CO₂)



Narrow freezer with a total depth of only 765 mm



Panorama endwall for a better product visibility

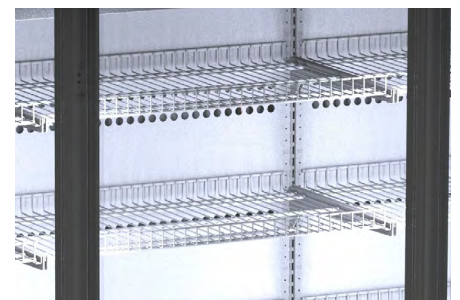

Slim brackets with 25 mm shelf spacing for an improved loading of products

Technical data



Velando® 53 390 L1 - 1 L

	Customer value	Velando® 53
Prime Line	Heavy product load	■
	Energy efficiency	■
	Streamlined operation	■
	Product visibility	■
	Installation/ Serviceability	■
	Floor space productivity	■
	Cabinet aesthetics	■

Name of product line

Bottom shelf depth: 5 – 500 mm

Front height: 3 – 300 mm

Cabinet length: – 3 900 mm

Temperature class: L1*

Revision index: 1

Cabinet height: L= – 2 220 mm

*Cabinet design according to EN ISO 23953 at climate class 3

Narrow merchandiser

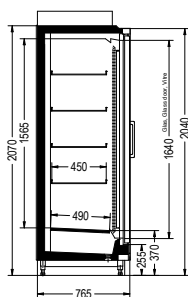

Velando® 53.L1-1

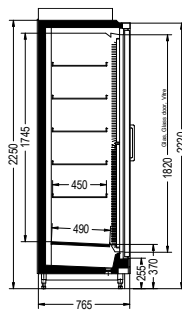

Velando® 53.L1-1L



Small Store



Supermarket



E6 Velando® 53 is the narrow freezer solution for small stores and supermarkets (20% less floor space vs. E6 Velando® AF)

E6 Velando® 53	Unit	53.L1-1
Max. height inside, S-height	mm	1590
Max. height inside, L-height	mm	1770
Bottom shelf depth	mm	490
Shelf depth	mm	450
Shelves STD-height (min. / standard / max.)	rows	3 / 4 / 5
Shelves L-height (min. / standard / max.)	rows	4 / 5 / 6
Load per module	kg / 79cm	290 (320)*
Module length (door) without endwalls (50 mm each)	2D-156	✓
	3D-235	✓
	4D-313	✓
	5D-390	✓
Temperature class L1 / Storage temp. -22/-24 °C		✓
Energy label**		E

* For cabinets with two endwalls | ** Label might change depending on configuration

E6 Velando® AF

Prime Line

Premium vertical freezer with large storage capacity

Space optimizer



Benefits at a glance

- Enhanced visibility of presented goods
- Large storage capacity
- Simplified maintenance
- Lower energy consumption with optional High Efficiency Frame

Standard configuration

- Anti-Fog (AF) non-heated passive glass doors
- Ergonomic door handles
- Vertical LED lighting
- Two piece cabinet front with bumper profile
- Single piece front kickplate
- Energy efficient EC fans
- Bottom evaporator (F-gas)
- Multiplex kit

Customization

- High Efficiency Frame (HEF) reduces energy consumption
- Panorama and non-glazed endwalls
- Horizontal LED lighting for canopy
- Large selection of display baskets, wire shelves, bottom racks, wire dividers and pricing rails
- Bulk section with telescopic basket
- Plinth front bumper and endwalls
- Bottom evaporator (CO₂)



Wide range of accessories with wire shelves, display baskets and telescopic display baskets for easy loading



The optional High Efficiency Frame with glass fiber-reinforced plastic significantly reduces the vertical freezers energy consumption



E6 Velando® AF with High Efficiency Frame (HEF) provides the best energy performance within freezer cabinet portfolio

Technical data



Customer value		Velando® AF		
Prime Line	Heavy product load			
	Energy efficiency			
	Streamlined operation			
	Product visibility			
	Installation/Serviceability			
	Floor space productivity			
	Cabinet aesthetics			

Velando® AF · 5D · 390 B8 · L

Name of product line
Glass door: AF = Anti-fog
Number of doors: 5
Cabinet length: ~ 3 900 mm
Revision index: B
Temperature range: 8 (-22/-24 °C)
Cabinet height: L ~ 2 200 mm

*Cabinet design according to EN ISO 23953 at climate class 3

Space optimizer

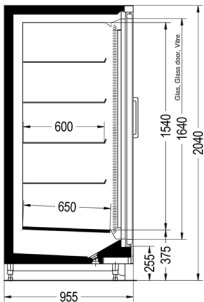

Velando® AF.B8

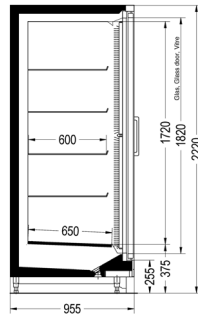

Velando® AF.B8L



Supermarket



Hypermarket

E6 Velando®	Unit	AF.B8 HEF	AF.B8
Max. height inside, S-height	mm	1540	1540
Max. height inside, L-height	mm	1720	1720
Bottom shelf depth	mm	650	650
Shelf depth (min. / standard / max.)	mm	550 / 600 / 600	550 / 600 / 600
Shelves STD-height (min. / standard / max.)	rows	3 / 4 / 6	3 / 4 / 6
Shelves L-height (min. / standard / max.)	rows	4 / 5 / 7	3 / 4 / 7
Load per module	kg / 79 cm	290 (320)*	290 (320)*
	2D-156	✓	✓
	3D-235	✓	✓
	4D-313	✓	✓
	5D-390	✓	✓
Temperature class L1 / Storage temp. -22/-24 °C		✓	✓
Energy label**		D	E

* For cabinets with two endwalls | ** Label might change depending on configuration

E6 Velando® QL AA CE

Prime Line

Energy efficient vertical freezer perfectly fit for gondola set up

Narrow merchandiser/ Flexible merchandiser



Benefits at a glance

- Energy efficient design
- Optimized for back-to-back set up
- High floor space productivity

Standard configuration

- High Efficiency Frame (HEF)
- Anti-Fog All-glass (AA) doors with heated all-glass frame
- Ergonomic door handles
- Panorama endwalls
- Vertical LED lighting
- Wire shelves and bottom basket
- Cabinet front with bumper profile
- Single piece front kickplate
- Energy efficient EC fans
- Bottom evaporator (F-gas)
- Multiplex kit

Customization

- Large selection of display baskets, wire shelves, bottom racks, wire dividers and pricing rails
- Plinth bumper for increased protection
- Bottom evaporator (CO₂)



Perfectly fitted for a gondola set up with E6 Velando® to complete the cabinet line
The slim doors of the 3D-191 version fits well in limited store space



The High Efficiency Frame with glass fiber-reinforced plastic significantly reduces the vertical freezer's energy consumption

Technical data



	Customer value	Velando® QL AA CE
Prime Line	Heavy product load	■ ■ ■ ■ ■ ■ ■ ■ ■ ■ ■ ■
	Energy efficiency	■ ■ ■ ■ ■ ■ ■ ■ ■ ■ ■ ■ ■
	Streamlined operation	■ ■ ■ ■ ■ ■ ■ ■ ■ ■ ■ ■ ■ ■
	Product visibility	■ ■ ■ ■ ■ ■ ■ ■ ■ ■ ■ ■ ■ ■ ■
	Installation/ Serviceability	■ ■ ■ ■ ■ ■ ■ ■ ■ ■ ■ ■ ■ ■ ■ ■
	Floor space productivity	■ ■ ■ ■ ■ ■ ■ ■ ■ ■ ■ ■ ■ ■ ■ ■ ■
	Cabinet aesthetics	■ ■ ■ ■ ■ ■ ■ ■ ■ ■ ■ ■ ■ ■ ■ ■ ■ ■ ■

Velando® QL AA 3D CE191 A8 1

Name of product line
Glass door: AA = Anti-fog, All-glass
Number of doors: 3
CE = Crown end version
Cabinet length: ~ 2 350 mm
Revision index: A
Temperature range: 8 (Storage temp. -22/-24 °C)
Cabinet height: L ~ 2 220 mm

*Cabinet design according to EN ISO 23953 at climate class 3

Narrow merchandiser/ Flexible merchandiser

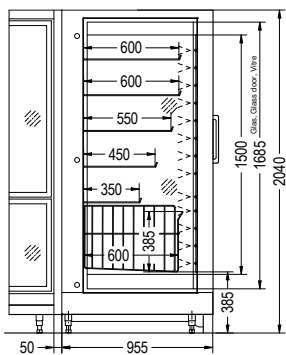

Velando® QL AA CE. A8

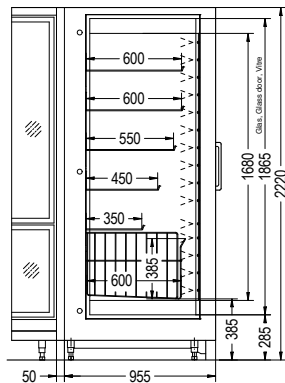

Velando® QL AA CE. A8 L



E6 Velando® QL CE	Unit	AA.A8 HEF
Max. height inside, S-height	mm	1540
Max. height inside, L-height	mm	1720
Bottom shelf depth	mm	650 (600)*
Shelf depth (min. / standard / max.)	mm	350 / - / 600
Shelves STD-height (min. / standard / max.)	rows	4 / 5 / 6
Shelves L-height (min. / standard / max.)	rows	4 / 5 / 7
Load per module	kg / 79cm	260
Basket Volume	CE 3D-191	430 l
Temperature class L1 / Storage temp. -22/-24 °C		✓
Energy Label**		E

* Basket depth | ** Label might change depending on configuration

E6 Velando® SG 63

Value Line

Basic vertical freezer with high standards for your sales

Space optimizer



Benefits at a glance

- Enhanced visibility of presented goods
- Large storage capacity
- Simplified maintenance

Standard configuration

- Heated standard glass doors (SG)
- Ergonomic door handles
- Vertical smart LED lighting
- Two piece cabinet front with bumper profile
- Single piece front kickplate
- Energy efficient EC fans
- Bottom evaporator (F-gas)
- Multiplex kit

Customization

- Panorama and non-glazed endwalls
- Horizontal LED lighting for canopy
- Large selection of display baskets, wire shelves, bottom racks, wire dividers and pricing rails
- Bulk section with telescopic basket
- Plinth front bumper and endwalls
- Bottom evaporator (CO₂)



Wide range of accessories with wire shelves, display baskets and telescopic display baskets for easy loading

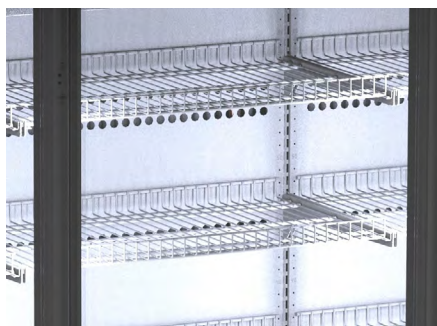

Slim brackets with 25 mm shelf spacing for an improved loading of products



The optional plinth bumper provides an increased cabinet protection

Technical data



	Customer value	Velando® SG 63			
Value Line	Heavy product load	■	■	■	■
	Energy efficiency	■	■	■	■
	Streamlined operation	■	■	■	■
	Product visibility	■	■	■	■
	Installation/Serviceability	■	■	■	■
	Floor space productivity	■	■	■	■
	Cabinet aesthetics	■	■	■	■

Velando® SG 63 . 390 L1 - 1 L

Name of product line

Glass door: SG = Standard glass

Bottom shelf depth: 6 ~ 600 mm

Front height: 3 ~ 300 mm

Cabinet length: ~ 3 900 mm

Temperature class: L1*

Revision index: 1

Cabinet height: L= ~ 2 220 mm

*Cabinet design according to EN ISO 23953 at climate class 3

Space optimizer

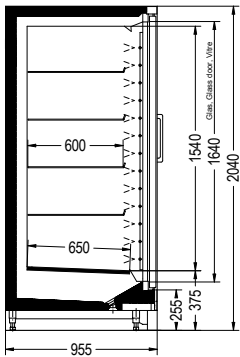

Velando® SG 63.L1-1



Supermarket

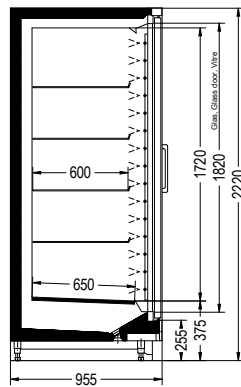

Velando® SG 63.L1-1L







Hypermarket

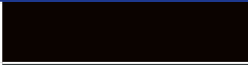

E6 Velando® SG	Unit	63.L1-1
Max. height inside, S-height	mm	1540
Max. height inside, L-height	mm	1720
Bottom shelf depth	mm	650
Shelf depth (min. / standard / max.)	mm	550 / 600 / 600
Shelves STD-height (min. / standard / max.)	rows	3 / 4 / 6
Shelves L-height (min. / standard / max.)	rows	3 / 4 / 7
Load per module	kg / 79cm	290 (320)*
Module length (door) without endwalls (50 mm each)	2D-156	✓
	3D-235	✓
	4D-313	✓
	5D-390	✓
Temperature class L1 / Storage temp. -22/-24 °C		✓
Energy label**		

* For cabinets with two endwalls | ** Label might change depending on configuration

E6 Color Concept Vertical Freezers

Exterior	Standard color	Optional colors
Canopy panel	Signal White	See Carrier Colors guide
Endwall		

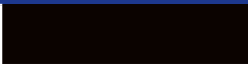
Plastic parts	
Deep Black (FA 9005)	
Anthracite (FA 7016)	
Grey (FA 0502)	
Stratus Grey (FA 0632)	
Cirrus Grey (FA 0631)	

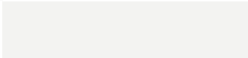
Grid & wire	
Deep Black (FA 9005)	
White Aluminium (FA 9006)	
Signal White (FA 0605)	



Front	Standard color	Optional colors
Price rails	Signal White	Deep Black
Return air grille	Deep Black	See Carrier Colors Guide
Plinth bumper (not shown)	Stratus Grey	-
Decor front panel	Stratus Grey	Grey, Cirrus Grey, Traffic Red, Deep Black, Anthracite
Kickplate	Nimbus Grey	See Carrier Colors Guide



Interior	Standard color	Optional colors
Display shelves	Signal White	See Carrier Colors Guide
Air baffle plate		
Bottom deck		
Ceiling panelling		
Endwall (solid)	Stratus Grey	Signal White, Deep Black
Endwall (panorama)	Stratus Grey	-
Grid, Divider, Wire, Basket	Signal White	Deep Black, White Aluminium

Door handle options

Velando®



White Aluminium/
Stratus Grey

Velando® QL CE



Deep Black/
Stratus Grey

Door design options

Velando®



Aluminium or Black design

Velando® QL CE



Black or Aluminium All-glass
door design

Doors	Standard color	Optional colors
Frame (Standard)	White Aluminium	-
Frame (HEF)	Black	-
Door (Frame)	Matt Silver/Telegrey	Black
Door (Frame) QL	Black	Matt Silver/Telegrey
Door handle (Holders/Tube)	Stratus Grey	-
Door handle (Holders/Tube) QL	Stratus Grey	Deep Black

E6 Light & Glass Door Program Vertical Freezers

E6 Virando® 63 with vertical & horizontal LED lighting



E6 Velando® 53 with vertical & horizontal LED lighting



E6 Velando® AF with vertical & horizontal LED lighting



PRODUCT LINE	E6 Virando® 63	E6 Velando® 53	E6 Velando® AF	E6 Velando® AF (HEF)	E6 Velando® QL AA CE	E6 Velando® SG 63
LED TYPE						
VERTICAL/DOOR MULLION						
Premium LED						
5000 K	✓	✓	✓	✓	✓	✓
4000 K	-	-	-	✓	-	-
Exclusive LED						
5600 K	✓	✓	✓	-	-	✓
Smart LED						
5000 K	-	✓	✓	-	-	✓
HORIZONTAL/CANOPY						
Premium LED						
5000 K	✓	✓	✓	✓	✓	-

Vertical Freezer	Glass Door Type					
	Anti-Fog (AF) "Non-heated Passive Door"		Anti-Fog All-glass (AA) "Heated Door (Frame Only)"		Standard Glass (SG) Heated Door	
	Aluminium Frame		All-glass Frame		Aluminium Frame	
	White-aluminium	Black	White-aluminium	Black	White-aluminium	Black
	E6 Virando® 63	-	-	-	✓	-
E6 Velando® 53	✓	✓	-	-	-	-
E6 Velando® AF	✓	✓	-	-	-	-
E6 Velando® QL AA CE	-	-	✓	✓	-	-
E6 Velando® SG 63	-	-	-	-	✓	✓

Endwalls E6 Vertical Freezers

E6 Virando® 63

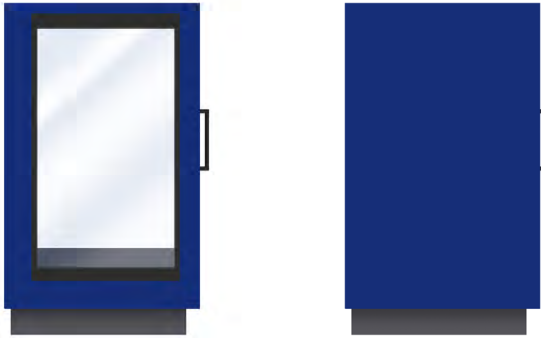

E6 Velando® 53

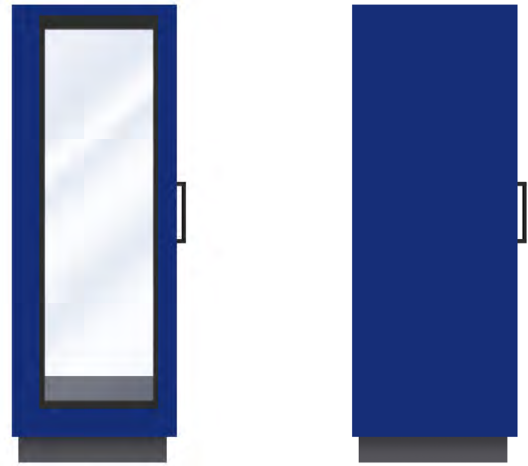

E6 Velando® AF / E6 Velando® SG 63 / E6 Velando® QL AA CE*

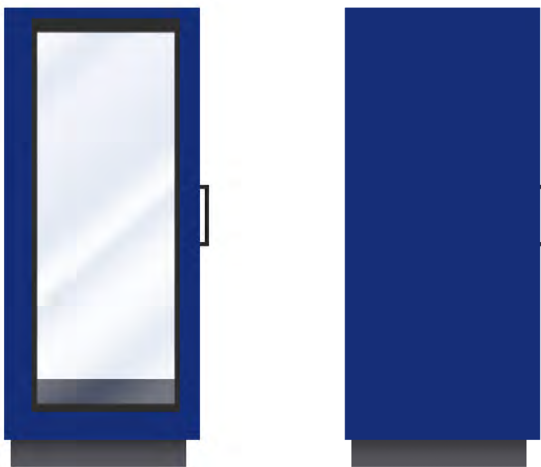

* Only with panorama endwall



Vertical freezer with part-glazed dividing wall (available only for S-height), and Island with non-glazed endwall

Vertical Freezer	Endwall Type		Dividing Wall Type	
	Panorama	Non-glazed	Non-glazed for	Part-glazed for
E6 Virando® 63	✓	✓	-	-
E6 Velando® 53	✓	✓	✓	-
E6 Velando® AF	✓	✓	✓	✓*
E6 Velando® QL AA CE	✓	-	-	-
E6 Velando® SG 63	✓	✓	✓	✓*

* Multiplexing with Irios® GL+

Accessories E6 Vertical Freezers

Price Marking

Accessories	E6 Virando® 63	E6 Velando® 53	E6 Velando® AF	E6 Velando® QL AA CE	E6 Velando® SG 63
Scanner pricing rails at wire shelf					
Scanner pricing rail, 38 mm, 1 door	•	•	•	•	•
Scanner pricing rail, 40 mm, 1 door	•	•	•	•	•
Scanner pricing rail, 52 mm, 1 door			•	•	•
Scanner pricing rail, 60 mm, 1 door	•	•	•	•	•
Scanner pricing rails at bottom wire shelf					
Scanner pricing rail, 38 mm, for bottom rack, 1 door	•	•	•		•
Scanner pricing rail, 40 mm, for bottom rack, 1 door				•	
Scanner pricing rail, 52 mm, for bottom rack, 1 door			•	•	•
Scanner pricing rail, 60 mm, for bottom rack, 1 door	•	•	•	•	•
Pricing rail holders at wire shelf					
Pricing rail holder, Form R, rack 1 door	•	•	•	•	•
Price marking, others					
Holder advertising			○		○
Pricing rail for electronic marking, Form F, end-to-end	•	•	•		•
Pricing rail for electronic marking, Form F, front-back			•	•	•
Pricing rail for electronic marking, Form F, basket	•	•	•		•
Pricing rail marking, Form K, bottom basket			•	•	•

• Available ○ Available except special dimensions

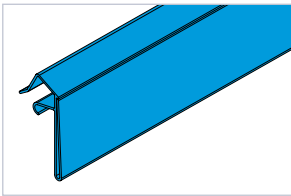

Scanner pricing rail, 38 mm, 1 door

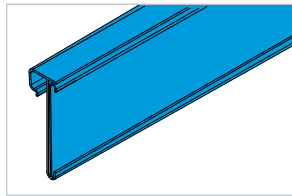

Scanner pricing rail, 40 mm, 1 door

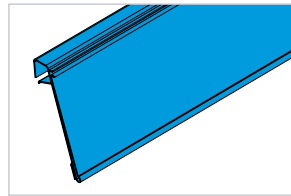

Scanner pricing rail, 52 mm, 1 door

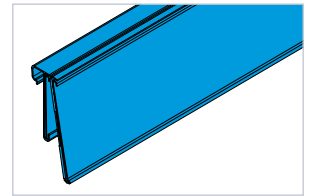

Scanner pricing rail, 60 mm, 1 door

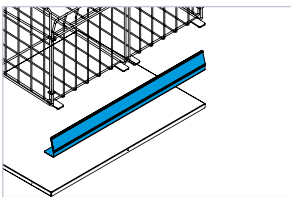

Scanner pricing rail, 38, 40, 52, 60 mm, for bottom rack, 1 door

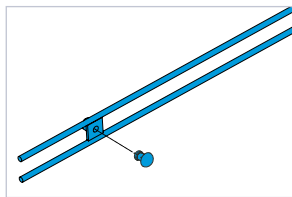

Holder for pricing tags for display shelf, Length 078

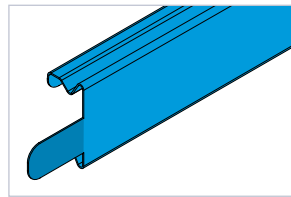

Pricing rail holder, form R, rack 1 door

Display Shelves

Accessories	E6 Virando® 63	E6 Velando® 53	E6 Velando® AF	E6 Velando® QL AA CE	E6 Velando® SG 63
Display baskets					
Display basket, depth 530 mm, height 200 mm, 1 door			•		•
Display basket	○	○	•	•	•
Wire shelves					
Wire shelf, rods end-to-end	•	•	•	•	•
Wire shelf, rods front-back	•	•	•	•	•

• Available ○ Available except special dimensions

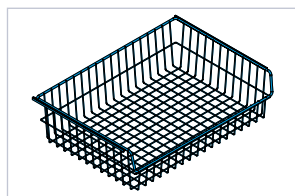

Display basket, depth 350, 400, 450, 500, 530 mm

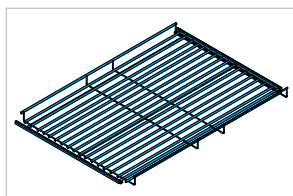

Wire shelf, rods end-to-end

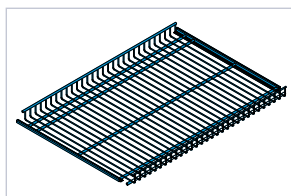

Wire shelf, rods front-back

Appearance and measurement may slightly differ

Accessories E6 Vertical Freezers

Tub Accessories

Accessories	E6 Virando® 63	E6 Velando® 53	E6 Velando® AF	E6 Velando® QL AA CE	E6 Velando® SG 63
Bottom racks					
Bottom rack rods front-back, with product stop, 1 door	•	•	•		•
Bottom rack rods end-to-end, with product stop, 1 door	•	•	•		•
Wire shelf, rods end-to-end, Length 63 (vertical)	•		•		•
Wire shelf, rods front-back, Length 63 (vertical)	•		•		•
Bottom display baskets					
Bottom display basket, 1 door	•	•	•		•
Bottom display basket, lower front, 1 door	•	•	•		•
Bottom display basket, telescopic	•		•	•	•
Bottom, goods basket (2 pcs.) per 1 door			•	•	•
Wire dividers					
Wire divider for endwall		•			•
Wire divider for bottom basket	•	•	•		
Wire divider for bottom basket low front		•	•		•
Wire divider for bottom deck, end-to-end	•	•	•		
Wire divider, front-back	•	•	•		•
Wire divider for telescopic, display basket				•	
Wire divider for goods basket				•	
Plexi divider for bottom deck			•	•	•

• Available



Inox bumper by local customization

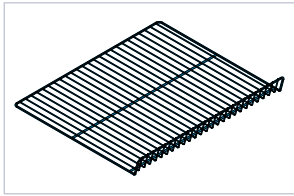

Bottom rack rods front-back, with product stop, 1 door

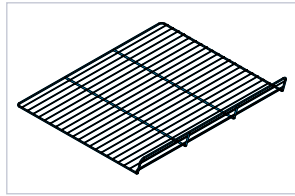

Bottom rack rods end-to-end, with product stop, 1 door

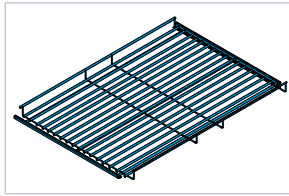

Wire shelf, rods end-to-end, Length 63 (vertical)

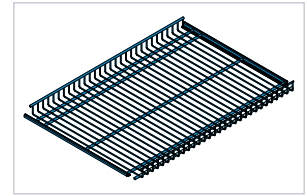

Wire shelf, rods front-back, Length 63 (vertical)

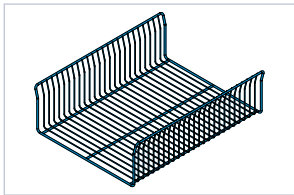

Bottom display basket, 1 door

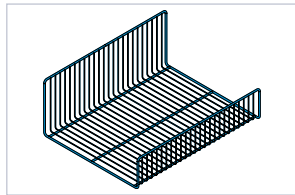

Bottom display basket, lower front, 1 door

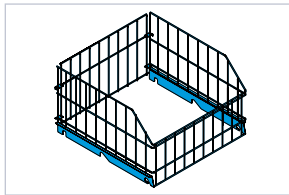

Bottom display basket, telescopic

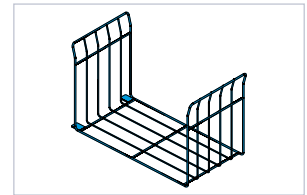

Bottom, goods basket (2 pcs.) per 1 door

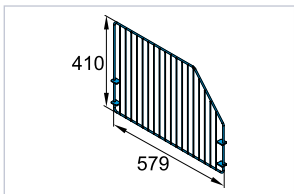

Wire divider for bottom basket

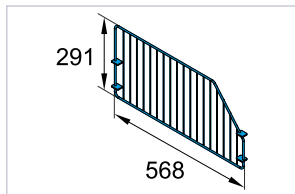

Wire divider for bottom basket in low front

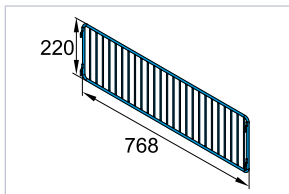

Wire divider for bottom deck, end-to-end

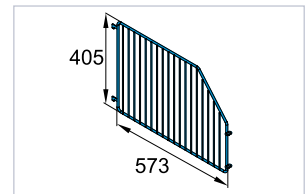

Wire divider, front-back

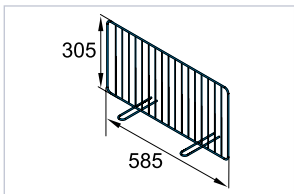

Wire divider for telescopic, display basket

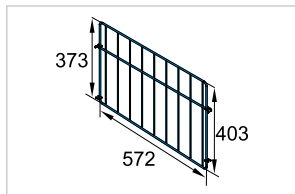

Wire divider for goods basket

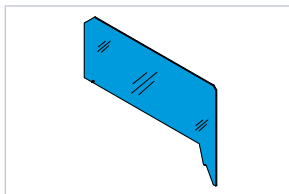

Plexi divider for bottom deck

Appearance and measurement may slightly differ



Wood optic cladding and exterior bumpers by local customization



Islands

Product Overview Islands

Freezer Islands

Flexible merchandiser

Inlcudes smart features

Narrow merchandiser

Requests limited floor space to operate

Space optimizer

Maximum floor space productivity

Prime Line



E6 Irios® GL

Flexible merchandiser



Ivando® SG4-GL+.C8



Irios® SG4-GL+.C8

Value Line

Narrow merchandiser



Wisalo® SG4-GL+.C8



AIB SG2-GL+.L1-1*

Prime Line: Energy efficient design with a wide range of module lengths, options and accessories

Value Line: Focus on essential features with limited range of module lengths, options and accessories

Chiller Islands

Flexible merchandiser

Includes smart features

Narrow merchandiser

Requests limited floor space to operate

Space optimizer

Maximum floor space productivity



EasyGo.M2-1

Flexible merchandiser



Ivando® SG4-GL+.C4



Irios® SG4-GL+.C4

Narrow merchandiser



AIB SG2-GL+.M1-1*

* External corner protection is a local installation (and not available from factory).

E6 Irios® GL

Prime Line

Closed island – transparency on the next level



Benefits at a glance

- Increased transparency for better product visibility from all sides
- Comfortable and ergonomic product access
- Modern square design & various customization options for individual style

Standard configuration

- Push-T glass lid system for longitudinal cabinets
- Push-3 glass lid system for crown end (CE) cabinets
- Slim handrail located on lower level at only 89,5 cm height for better product access
- Exterior plastic profile color in dark grey or light grey*
- Fully glazed panorama endwalls
- Improved LED handrail lighting
- Integrated bumper
- Dark grey handle
- Interior price rail near handrail

Customization

- Transparent handle
- External bumper for increased protection
- Customizable claddings for example in wooden pattern*
- Improved LED lighting for sidewalls
- Improved LED lighting for middle wall*
- Gable price rail with two or three partitions (40 mm or 60 mm)
- Square stainless-steel bumper for increased protection
- Removable 1,25 m glass superstructure shelf with price rails for product load up to 60 kg/module



15% larger glass surfaces and improved LED lighting on handrails, middle beam* and sidewalls for excellent product visibility



Easy to open, curved glass lids reducing light reflections and transparent profiles provide perfect transparency

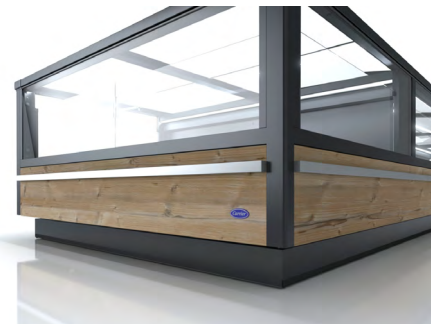

Fully glazed panorama endwalls and sidewalls with optional cladding* in wooden pattern and stainless steel bumpers

* This feature is available from approx. Q3-2022 (availability needs to be confirmed before ordering)

Technical data



	Customer value	Irios® GL			
Prime Line	Heavy product load	■	■	■	■
	Energy efficiency	■	■	■	■
	Streamlined operation	■	■	■	■
	Product visibility	■	■	■	■
	Installation/Serviceability	■	■	■	■
	Floor space productivity	■	■	■	■
	Cabinet aesthetics	■	■	■	■

Irios®	GL	375	L1	-	1
Name of product line					
Cabinet top: Glass lids					
Cabinet length: ~ 3 750 mm					
Temperature class: L1*					
Revision index: 1					

*Cabinet design according to EN ISO 23953 at climate class 3

Space optimizer

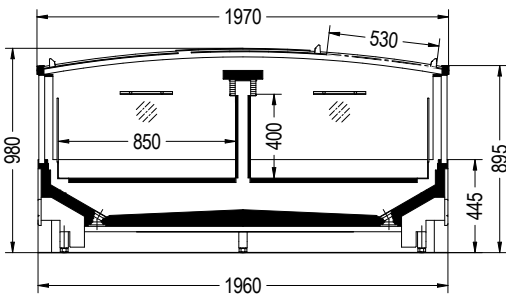

Irios® GL

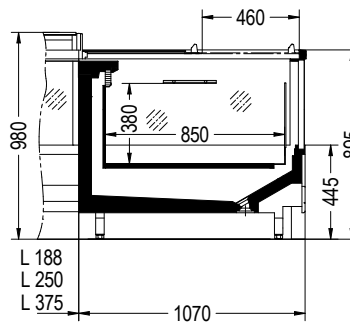

Irios® GL CE



E6 Irios® GL	Unit	188	250	375	CE183
Height	mm	980	980	980	895
Depth	mm	1970	1970	1970	1070
Length without endwalls (65 mm each)	mm	1875	2500	3750	1830
Useful volume	l	1280	1700	2550	590
Temperature class L1 / Storage temp. -22/-24 °C		✓	✓	✓	✓
Energy label*		A G E	A G E	A G E	A G E

* Label might change depending on configuration

Open chiller island – highlighting your special products

Space optimizer



Benefits at a glance

- Modern squared design with frameless 360° glazing
- Excellent display for pre-packaged products
- Enhanced product visibility with various cladding options

Standard configuration

- Single front glass panel
- Panoramic endwall
- Paintable metal front panel for individual style
- Fully glazed panorama endwalls
- Energy-efficient EC fans
- Bottom evaporator (F-gas)

Customization

- Wooden front panel
- Squared stainless steel bumpers on the fronts and sides, 20x20mm (brushed)
- External bumper for increased protection
- Stainless steel interior
- Premium LED for canopy (middle beam)
- Plinth lighting with Premium LED for an attractive store atmosphere
- Bottom evaporator (CO₂)



Cladding options available in wood or metal with or without stainless steel bumpers



Optional external lighting at the bottom of the island provides an inviting ambience in the store



Frameless front single glazing and panoramic endwalls ensure best product visibility

Closed freezer and chiller island with classic basic design

Space optimizer



Benefits at a glance

- Available as freezer and chiller cabinet
- Large product facing area
- Flexible layout
- Heavy product load

Standard configuration

- Curved, frameless sliding glass lids for longitudinal cabinet
- Flat sliding glass lids for crown end
- Insulating front glass with 385 mm height
- White powder-coated internal fittings
- Superstructure for price rails with two partitions
- Single-piece kickplates
- Energy efficient EC fans
- Bottom evaporator (F-gas)
- Multiplex kit

Customization

- Push-2 or Push-3 glass lids
- Aluminium handrail
- LED lighting for handrail & front and back
- Island superstructures for optimized footprint productivity
- Large selection of wire shelves, covers, product divider and price rails
- Reinforced front bumper, endwall and dividing wall
- Plinth front bumper and endwall
- Bottom evaporator (CO₂)

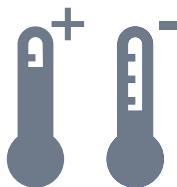

Irios® GL+ is available in temperature class M2 and L1 to present normal or low temperature goods

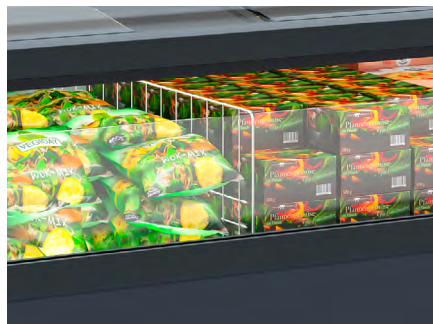

The durable design is perfectly suitable for heavy product loads



Superstructures for price rails with 3 partitions and additional dry superstructure shelf to extend your sales per m²

Technical data



	Customer value	Irios® GL+
Value Line	Heavy product load	■ ■ ■ ■ ■ ■ ■ ■ ■ ■
	Energy efficiency	■ ■ ■ ■ ■ ■ ■ ■ ■ ■
	Streamlined operation	■ ■ ■ ■ ■ ■ ■ ■ ■ ■
	Product visibility	■ ■ ■ ■ ■ ■ ■ ■ ■ ■
	Installation/Serviceability	■ ■ ■ ■ ■ ■ ■ ■ ■ ■
	Floor space productivity	■ ■ ■ ■ ■ ■ ■ ■ ■ ■
	Cabinet aesthetics	■ ■ ■ ■ ■ ■ ■ ■ ■ ■

	Irios®	SG4	GL+	375	C8
Name of product line					
Glass design: Standard glass					
Glass height: ~ 400 mm					
Cabinet top: Glass lids					
Cabinet length: ~ 3 750 mm					
Revision index: C					
Temperature range: 8 (storage temp. -22/-24 °C)					

*Cabinet design according to EN ISO 23953 at climate class 3

Space optimizer

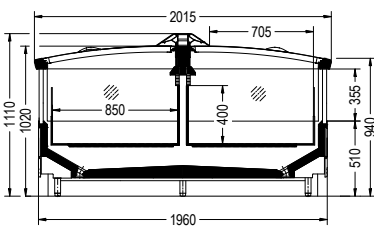

Irios® SG4-GL+.C4/8 e*cube

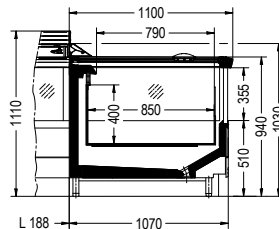

Irios® SG4-GL+.CE183 C4/8 e*cube



Supermarket



Hypermarket

Irios® GL+	Unit	188	250	375	CE183
Height	mm	1020	1020	1020	940
Depth	mm	1960	1960	1960	1070
Length without endwalls (65 mm each)	mm	1875	2500	3750	1830
Useful volume	l	1280	1700	2550	620
Temperature class M2 / Storage temp. 0/+2 °C 		✓	✓	✓	✓
Energy label* 		E	E	E	C
Temperature class L1 / Storage temp. -22/-24 °C 		✓	✓	✓	✓
Energy label* 		F	F	F	E

* Label might change depending on configuration

Ivando® GL+ & Wisalo® GL+

Value Line

Closed island with dual compartment for high sales flexibility

Flexible merchandiser



Benefits at a glance

- Ivando® GL+ with dual compartments allows the use of two temperature ranges in one island
- Wisalo® GL+ for an optimal freezer solution for wallside displays
- High cabinet flexibility

Standard configuration

- Ivando® GL+ with two separately refrigerated display compartments
- Ivando® GL+ & Wisalo® GL+ with curved, frameless sliding glass lids
- Flat sliding glass lids for Ivando® GL+ crown end
- Insulating front glass with 385 mm height
- White powder-coated internal fittings
- Superstructure for price rails with two partitions
- Single-piece kickplates
- Energy efficient EC fans
- Bottom evaporator (F-gas)
- Multiplex kit

Customization

- Push-2 or Push-3 glass lids
- Aluminium handrail
- LED lighting for handrail & front and back
- Large selection of wire shelves, covers, product divider and price rails
- Reinforced front bumper, endwall and dividing wall
- Plinth front bumper and endwall
- Bottom evaporator (CO₂)



The two separately refrigerated display compartments permit joint presentation of normal and low temperature products in one cabinet



The classic island design with large-sized glass panels provides a clear view of the product variety even from long distances



The wallside display of Wisalo® GL+ is the optimal supplement for the freezer solution in your market

Technical data



Customer value		Ivando® GL+			
Value Line	Heavy product load	■	■	■	■
	Energy efficiency	■	■	■	■
	Streamlined operation	■	■	■	■
	Product visibility	■	■	■	■
	Installation/Serviceability	■	■	■	■
	Floor space productivity	■	■	■	■
	Cabinet aesthetics	■	■	■	■

Ivando® SG4 - GL+ 250 C8

Name of product line
Cabinet design: Standard glass
Glass height ~ 400 mm
Cabinet top: Glass lids
Cabinet length: ~ 2 500 mm
Revision index: C
Temperature range: 8 (Storage temp. -22/-24 °C)

Flexible merchandiser

Narrow merchandiser

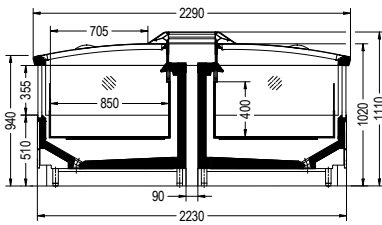

Ivando® SG4-GL+.C4/8 e*cube

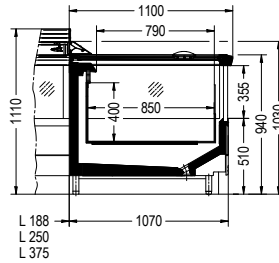

Ivando® SG4-GL+.CE210 C4/8 e*cube

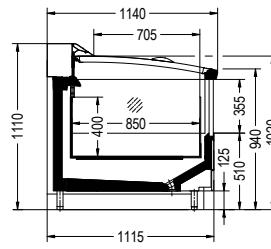

Wisalo® SG4-GL+.C8 e*cube



Ivando® GL+ & Wisalo® GL+	Unit	Ivando® GL+				Wisalo® GL+		
		188	250	375	CE210	188	250	375
Height	mm	1020	1020	1020	940	1020	1020	1020
Depth	mm	2230	2230	2230	1070	1115	1115	1115
Length without endwalls (65 mm each)	mm	1875	2500	3750	2100	1875	2500	3750
Useful volume	l	1280	1700	2550	725	640	850	1275
Temperature class M2 / Storage temp. 0/+2 °C 		✓	✓	✓	✓	-	-	-
Energy Label* 						-	-	-
Temperature class L1 / Storage temp. -22/-24 °C 		✓	✓	✓	✓	✓	✓	✓
Energy Label* 								

* Label might change depending on configuration

AIB GL+

Value Line

Closed island with small footprint for narrow aisles

Narrow merchandiser



Benefits at a glance

- Narrow depth for small footprint and flexible use
- Available as frozen & chiller island
- Classic reliable island design

Standard configuration

- Insulating front glass with 190 mm (SG2)
- Frameless sliding glass lids with safety glass
- White powder-coated internal fittings
- Superstructure for price rails with two partitions
- Integrated bumpers and single-piece kickplates
- Energy-efficient EC fans
- Bottom-evaporator (F-gas)
- Multiplex kit

Customization

- Horizontal LED lighting for handrail
- Island superstructure for more non tempered display space
- Large selection of wire shelves, wire dividers and price rails
- Bumper for endwall
- Bottom evaporator (CO₂)



The narrow depth of only 1490 mm provides a small footprint and allows use in limited store spaces

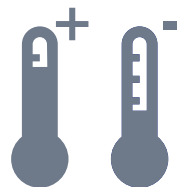

AIB SG2-GL+ is available in temperature class M1 and L1 to present normal or low temperature goods



AIB SG2-GL+ comes with glass panels for best product visibility

Technical data



	Customer value	AIB GL+
Value Line	Heavy product load	■ ■ ■
	Energy efficiency	■ ■ ■
	Streamlined operation	■ ■ ■ ■ ■
	Product visibility	■ ■ ■ ■ ■
	Installation/ Serviceability	■ ■ ■ ■ ■
	Floor space productivity	■ ■ ■ ■ ■
	Cabinet aesthetics	■ ■ ■ ■ ■

	AIB	SG2	GL+	375	L1	1
Name of product line	AIB SG2 - GL+ - 375 L1 - 1					
Cabinet design: Standard glass	AIB SG2 - GL+ - 375 L1 - 1					
Glass height: ~ 200 mm	AIB SG2 - GL+ - 375 L1 - 1					
Cabinet top: Glass lids	AIB SG2 - GL+ - 375 L1 - 1					
Cabinet length: ~ 3 750 mm	AIB SG2 - GL+ - 375 L1 - 1					
Temperature class: L1*	AIB SG2 - GL+ - 375 L1 - 1					
Revision index: 1	AIB SG2 - GL+ - 375 L1 - 1					

*Cabinet design according to EN ISO 23953 at climate class 3

Narrow merchandiser

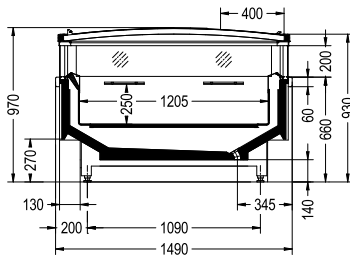

AIB SG2-GL+.L1/M1-1



AIB GL+	Unit	SG2	
		250	375
Height	mm	970	970
Depth	mm	1490	1490
Length without endwalls (105 mm each)	mm	2500	3750
Useful volume	l	753	1129
Temperature class M1 / Storage temp. -1/+1 °C 		✓	✓
Energy label***			
Temperature class L1 / Storage temp. -22/-24 °C 		✓	✓
Energy label***			

* At temperature class M1 | ** At temperature class L1 | *** Label might change depending on configuration

Glass Lid Program

Combination examples for island installations with crown end units:

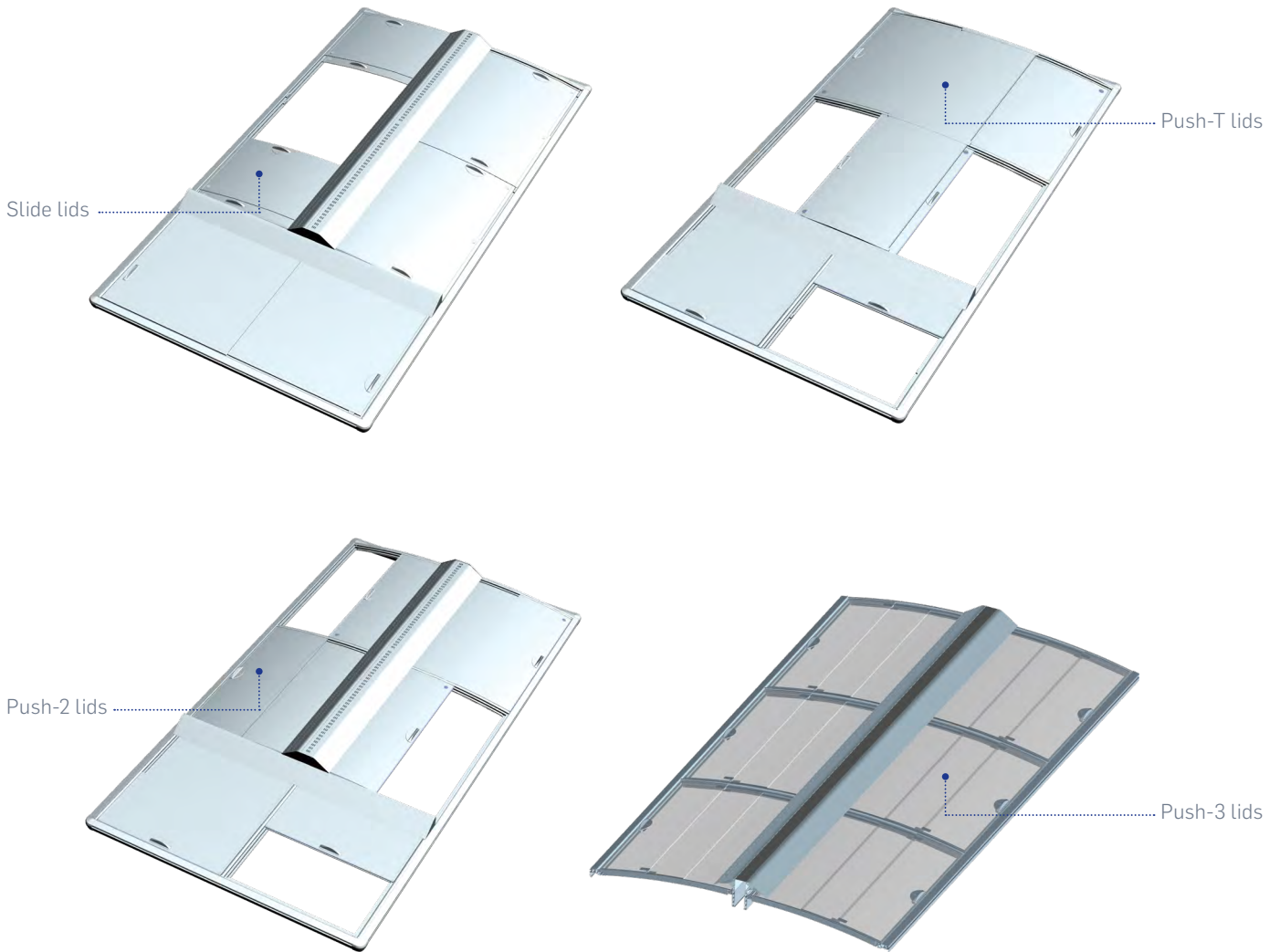

Overview of available glass lid types per cabinet family:

Islands	Lid shape	Glass Lid Type			
		Slide	Push-2	Push-3	Push-T
E6 Irios® GL	curved	✓*	-	✓*	✓
E6 Irios® GL CE	straight	✓*	-	✓	-
Irios® GL+	curved	✓	✓	✓	✓
Irios® GL+ CE	straight	✓	✓	✓	-
Ivando® GL+	curved	✓	✓	✓	-
Ivando® GL+ CE	straight	✓	✓	✓	-
Wisalo® GL+	curved	✓	✓	✓	-
AIB GL+	curved	✓	-	-	✓*

* In plan

Light Program Islands

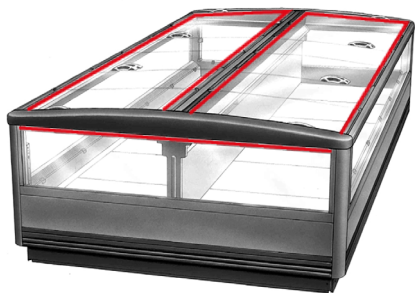

Irios® GL+ with canopy (middle beam) & handrail LED lighting (Lighting front and back)

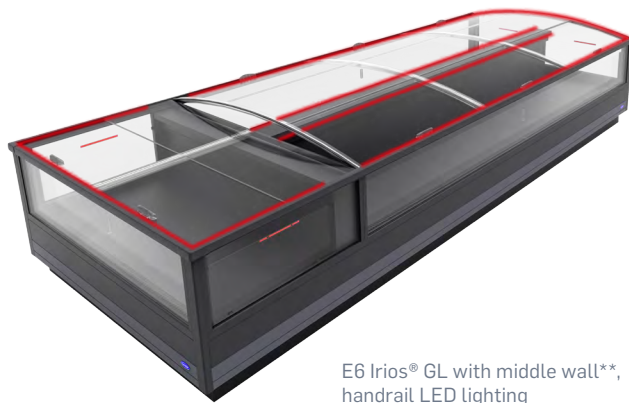

E6 Irios® GL with middle wall**, handrail LED lighting



AIB GL+ with handrail LED lighting for front and endwall

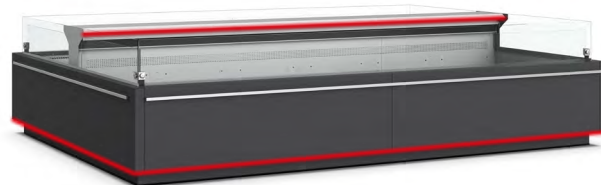

EasyGo with canopy (middle beam) & plinth LED lighting

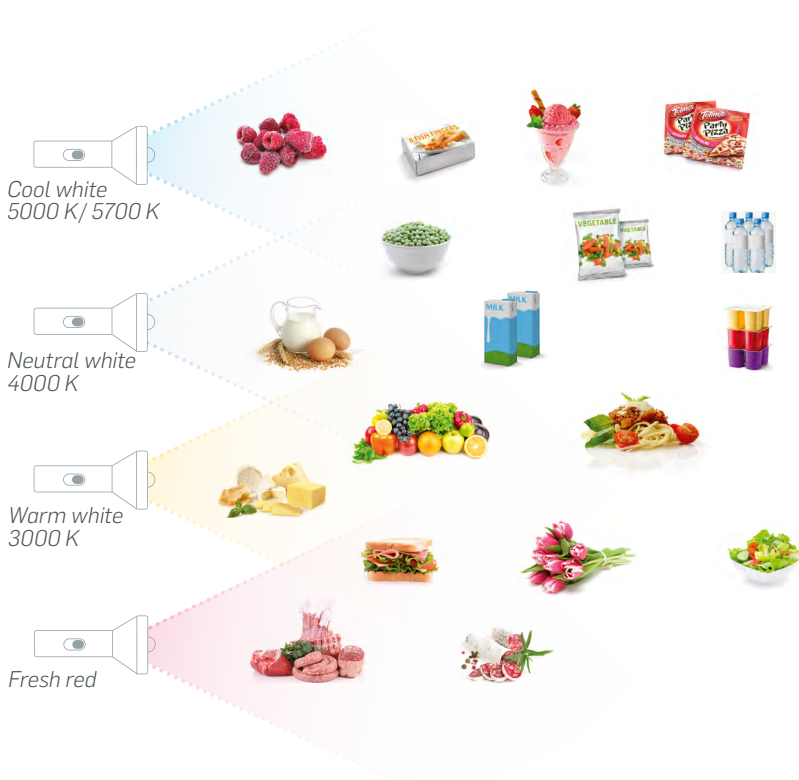

PRODUCT LINE	E6 Irios®	EasyGo	Irios® GL+	Ivando® GL+	Wisalo® GL+	AIB GL+
LED TYPE						
HANDRAIL (FRONT AND ENDWALL)						
Premium LED						
5000/5700 K	✓	-	✓	✓	✓	✓
4000 K	✓	-	✓	✓	✓	✓
3000 K	✓	-	✓	✓	✓	✓
FRESH RED	✓	-	✓	✓	✓	✓
CANOPY & HANDRAIL (LIGHTING FRONT AND BACK)						
Premium LED						
5000/5700 K	✓	✓*	✓	✓	✓	-
4000 K	✓	✓*	✓	✓	✓	-
3000 K	✓	✓*	✓	✓	✓	-
FRESH RED	✓	✓*	✓	✓	✓	-
PLINTH						
Premium LED						
5000/5700 K	-	✓	-	-	-	-
4000 K	-	✓	-	-	-	-
3000 K	-	✓	-	-	-	-
FRESH RED	-	✓	-	-	-	-

* Canopy only

** This feature is available from approx. Q3-2022 (availability needs to be confirmed before ordering)

Color Concept E6 Irios® GL





Exterior (Cabinet Top)	Standard color	Optional color
Handrail Decor Profile	Anthracite	Window Grey*
Handrail Decor Profile Corner (Crown End)	Anthracite	Window Grey
Horizontal Lids Running Profile	Anthracite	Window Grey
Lids Profile	Anthracite	Window Grey
Lids Handle	Anthracite	Window Grey, Transparent

* available ca. middle of 2022

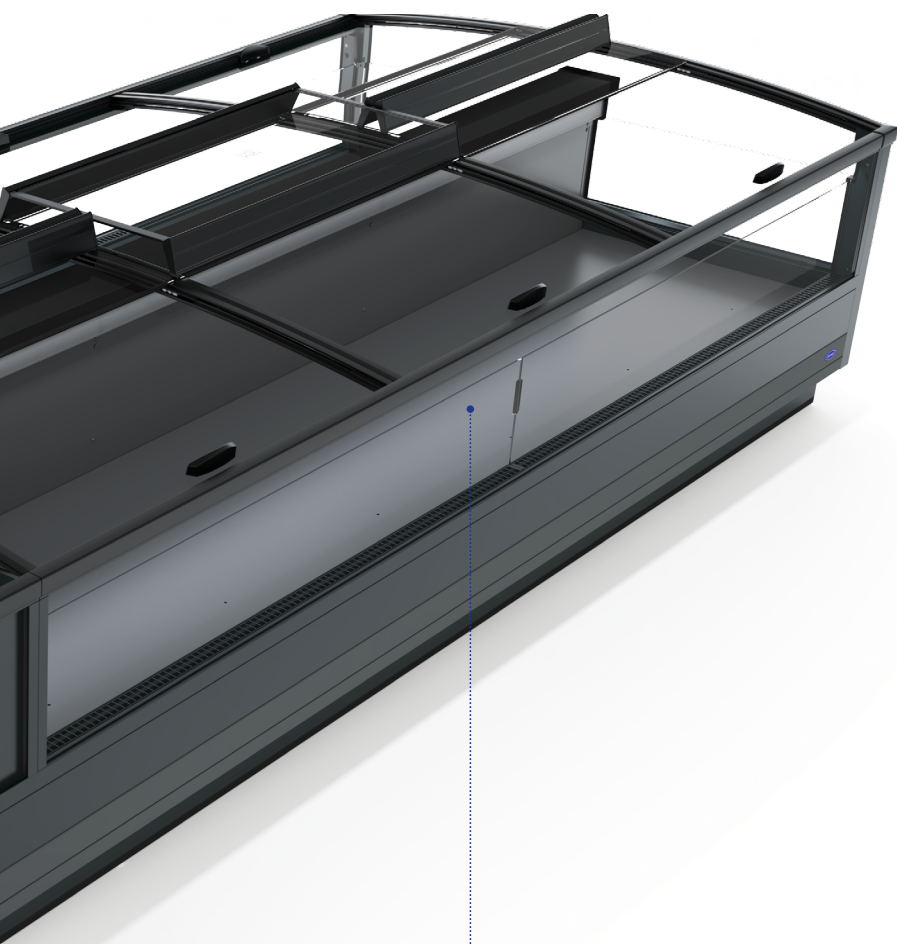

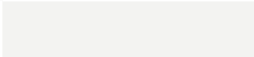
Exterior (Cabinet Front)	Standard color	Optional color
Corner Profile	Anthracite	Window Grey
Glass Trim Profile	Anthracite	Window Grey
Front Panel	Nimbus Grey	See Carrier Colors Guide
Plinth panel	Stratus Grey	Anthracite, Cirrus Grey, Jet Black
Kickplate	Nimbus Grey	See Carrier Colors Guide



Colors	
Anthracite (FA 7016)	
Signal White (FA 0605)	
Cirrus Grey (FA 0631)	
Jet Black (FA 9005)	
Window Grey (FA 0528)	



Front panels with optional cladding in wooden pattern and stainless steel bumpers



Interior	Standard color	Optional color
Air Return Grid	Signal White	See Carrier Colors Guide
Interior Plastic	Anthracite	Window Grey*
Endwall / Backwall (Crown End)	Signal White	Stratus Grey, Signal White
Grid, Wire Basket	Signal White	Deep Black; White aluminium

* available ca. middle of 2022

Color Concept Islands GL+

Exterior	Standard color	Optional colors
Handrail	Anthracite	Signal Grey
Endwall	White	See Carrier Colors Guide
Exterior		

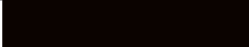
Plastic & aluminium parts (handrails)	
Anthracite (FA 7016)	
Anthracite (Aluminium) (FA 7016)	
Signal Grey* (FA 7004)	

Grid & wire	
Deep Black (FA 9005)	
White Aluminium (FA 9006)	
White (FA 0117)	



Front	Standard color	Optional colors
Kickplate	Duran Grey	See Carrier Colors Guide
Color strip front	Herlit Grey	
Decor front panel	White	
Return air grille	Herlit Grey	White, Herlit Grey, Deep Black, Anthracite, Grey
Moulded section for front	Duran Grey	

Interior	Standard color	Optional colors
Bottom deck		
Interior equipment	White	See Carrier Colors Guide
Air baffle plate		
Endwall	White	Herlit Grey, Deep Black, Grey
Grid, Wire, Basket	White	Deep Black, White Aluminium



Standard handle
for all glass lid options



Handle color: Anthracite

Island Accessories

Price Marking

Accessories	E6 Irios® GL	E6 Irios® GL CE	EasyGo	EasyGo CE	Irios® GL+	Irios® GL+ CE	Ivando® GL+	Ivando® GL+ CE	Wisalo® GL+	AIB SG2-GL+
Scanner pricing rails										
Scanner pricing rail, 40 mm	•	•	•	•	•	•	•	•	•	•
Scanner pricing rail, 40 mm (handrail lighting)	•	•								
Scanner pricing rail, 52 mm	•	•	•	•	•	•				
Scanner pricing rail, 52 mm (handrail lighting)					•	•				
Scanner pricing rail, 60 mm	•	•	•		•	•	•	•	•	•
Pricing rail holders										
Pricing rail for electronic marking, Form F			•	•						
Superstructures for scanner pricing rails										
Superstructure for pricing rail 2 partitions	•	•			•		•		•	•
Superstructure for pricing rail 3 partitions	•	•			•	•	•	•	•	•
Superstructure for pricing rail 2 partitions M					•		•		•	•
Superstructure for pricing rail 3 partitions M					•	•	•	•	•	•
Superstructure for pricing rail 2 partitions with holders for signage	•	•								
Superstructure for pricing rail 3 partitions with holders for signage	•	•								

• Available



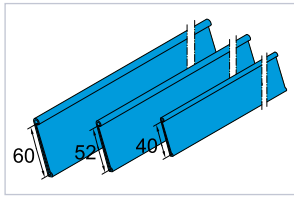

Scanner pricing rail, 40, 52, 60 mm

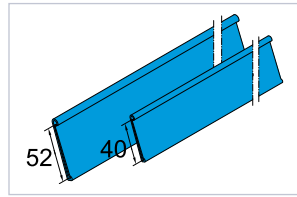

Scanner pricing rail, 40, 52 mm (handrail lighting)

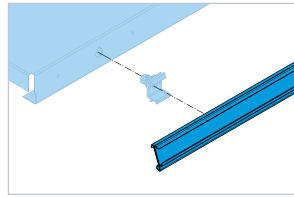

Pricing rail for electronic marking, Form F (ESL), Fig. 1

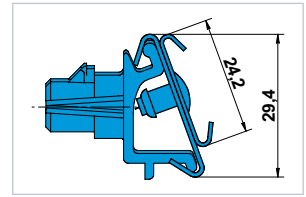

Pricing rail for electronic marking, Form F (ESL), Fig. 2

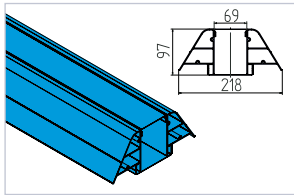

Superstructure for pricing rail 2 partitions*

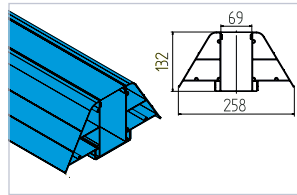

Superstructure for pricing rail 3 partitions*

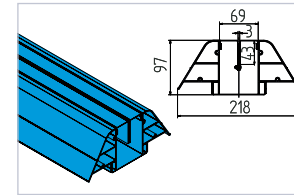

Superstructure for pricing rail 2 partitions M*

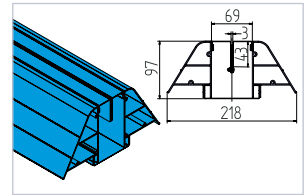

Superstructure for pricing rail 3 partitions M*

Appearance and measurement may slightly differ
*Illustration example for Push-T lids



Island Accessories

Island/Centre Superstructures

Accessories	Irios® GL+	Irios® GL+ CE	Ivando® GL+	Ivando® GL+ CE	Wisalo® GL+	AIB SG2-GL+
Island superstructures, 1-tier						
Island superstructure, 1280/700	•					
Island superstructure, 1-tier, 1380/550						•
Island superstructure, 1-tier, 1400/700	•					
Island superstructure, 1-tier, 1600/550						•
Island superstructures, 2-tier						
Island superstructure, 2-tier, 1600/550/350						•
Island superstructure, 2-tier, 1600/700/550	•					
Superstructure lighting, 1-row above, Premium LED	•					•
Superstructure lighting, 1-row bottom, Premium LED						•
Panels for island/centre superstructures						
End trim for island superstructure, 1-tier, right/left	•					•
End trim for island superstructure, 2-tier, right/left	•					•
Price marking						
Scanner pricing rail, 40 mm, island superstructure	•	•	•	•	•	•
Scanner pricing rail, 52 mm, island superstructure	•	•	•	•	•	•
Scanner pricing rail, 60 mm, island superstructure	•	•	•	•	•	•

• Available

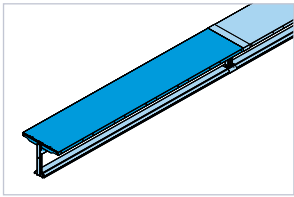

Island superstructure, 1-tier

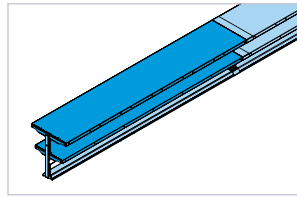

Island superstructure, 2-tier

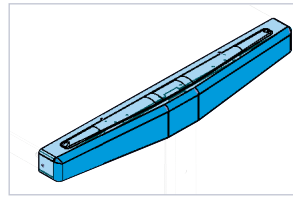

End trim for island superstructure, 1-tier, right/left

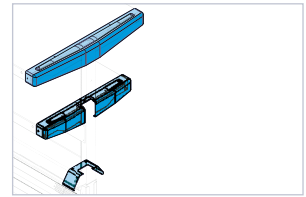

End trim for island superstructure, 2-tier, right/left

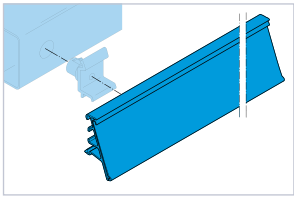

Scanner pricing rail, 40 mm, island superstructure

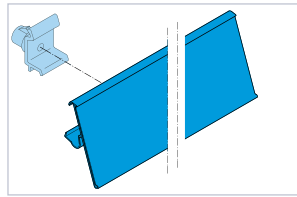

Scanner pricing rail, 52 mm, island superstructure

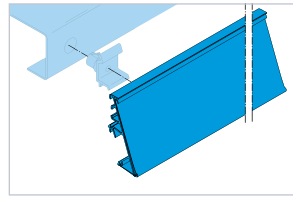

Scanner pricing rail, 60 mm, island superstructure

Appearance and measurement may slightly differ



Wooden cladding by local customization

Island Accessories

Tub Accessories

Accessories	E6 Irios® GL	E6 Irios® GL CE	EasyGo	EasyGo CE	Irios® GL+	Irios® GL+ CE	Ivando® GL+	Ivando® GL+ CE	Wisalo® GL+	AIB SG2-GL+
Bottom rack										
Wire shelf, rods front-back, Length 63	•	•	•		•	•	•	•	•	
Wire shelves										
Wire shelf, rods end-to-end, Length 63			•	•						○
Wire shelf, rods front-back, Length 72							•			
Wire shelf, 1/2 depth, height-adjustable, rods front-back										•
Wire dividers										
Product divider for single-serving packages, Length 205 mm	•	•	•	•	•	•	•	•	•	
Wire divider for endwall	•	•	•	•	•	•	•	•	•	•
Wire divider, end-to-end, 1250 mm										•
Wire divider, front-back	•	•	•	•	•	•	•	•	•	•
Ice cream divider (vertical)					•	•	•	•	•	•
Ice cream divider (horizontal)					•	•	•	•	•	•
Basket for ice cream	•	•			•	•	•	•	•	•
Ice cream divider	•	•			•	•	•	•	•	•

• Available ○ Available except special dimensions

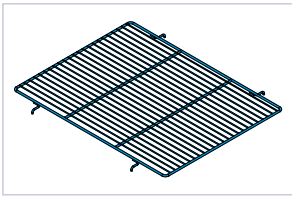

Wire shelf, rods front-back / 1/2 depth height-adjustable

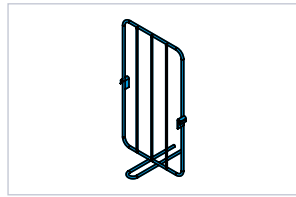

Product divider for single-serving packages, Length 205 mm

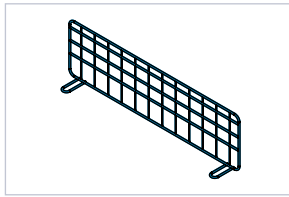

Wire divider for endwall

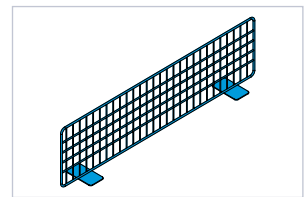

Wire divider, end-to-end, 1250 mm

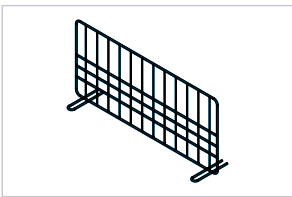

Wire divider, front-back

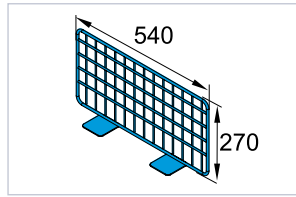

Wire divider, endwall, 1/2 depth

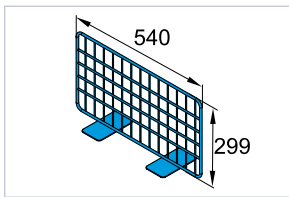

Wire divider, front-back, 1/2 depth

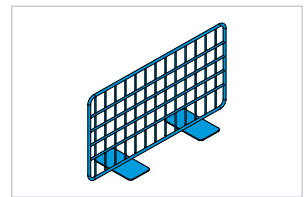

Wire divider, end-to-end, 625 mm

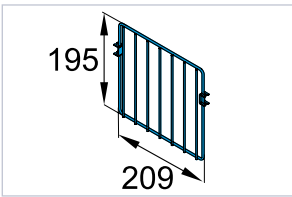

Ice cream divider (vertical)

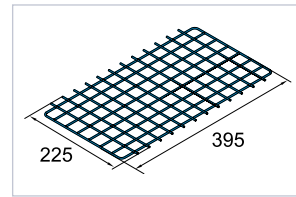

Ice cream divider (horizontal)

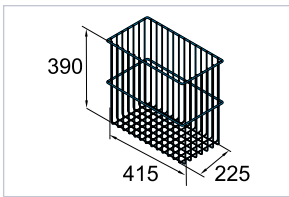

Basket for ice cream

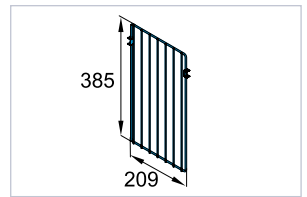

Ice cream divider

* Appearance and measurement may slightly differ



Plinth bumper at bottom by local customization





The EcoDesign regulation

The implementation of the EcoDesign directive for “refrigerated display cabinets with a direct sales function” was adopted by the European Union Commission in October 2019. The application date for the requirements is the 1st of March 2021. The directive applies to newly produced refrigerated cabinets only – the

systems, racks and condensing units are covered by other regulations. The compliance is declared by the manufacturer with the declaration of conformity and with providing technical data to a European database called EPREL and the CE-mark. A verification procedure will be applied by the member states.

All Carrier products presented in this catalogue are EcoDesign compliant.

Energy Labelling

The objective of Energy Labelling is to give clear, easy-to-understand label information on the product energy efficiency, and classify products according to their level of efficiency

(from G to A), with an overall effect of pulling the market towards more energy efficient products. Products marketed prior to March 2021 are not affected.

ENERGY EFFICIENCY CLASS	ENERGY EFFICIENCY INDEX
A	EEI < 10
B	10 ≤ EEI < 20
C	20 ≤ EEI < 35
D	35 ≤ EEI < 50
E	50 ≤ EEI < 65
F	65 ≤ EEI < 80
G	100 > EEI ≥ 80

The Label

Each new refrigerating appliance will be supplied with a printed label gathering energy related information:

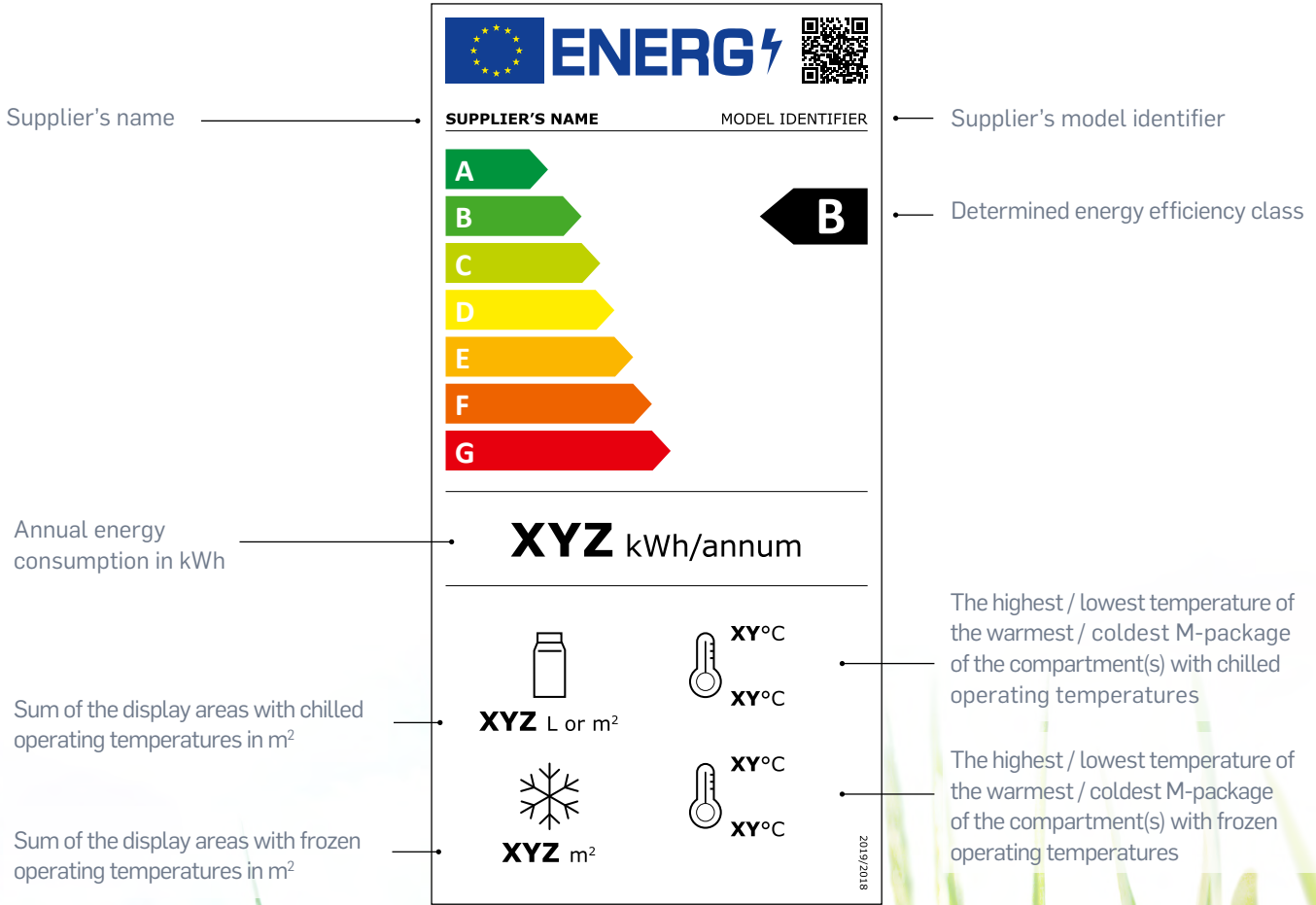

Powder Paint Selection Guide

When it comes to customization, Carrier offers a wide range of possibilities in the design of each product – from the front aesthetic to the endwalls and pedestals. These are available in a variety of designs, material finishings and colors. Through the creative use of colors, you can illustrate an inviting and pleasant atmosphere that evokes positive emotions. Shades of reds can express passion, enthusiasm, and energy; whereas blue and green express nature and freshness.

Essential colors

Benefit from a nice design at the best price level



Smart colors

Make the cabinet your style at the best value for money



Exclusive colors

Differentiate your market and customize your cabinet in a wide range of colors. Contact your local sales representative for more information.

Plug-in & remote cabinets in comparison

We can split the refrigerated display cabinets into two types. Remote cabinets have a common central condensing system which supplies several units with the refrigerant. The cabinets have a fixed location and are connected with pipes and wires to the central compressor rack and controller unit. Plug-in cabinets work like a household fridge and have the compressor, condenser and controller unit built into the cabinet itself; they only need a power supply. Both systems come with several advantages and trade-offs.

Plug-in system

Advantages:

- No piping / installation needed
- No machinery room
- Very flexible layout changes

Trade-offs:

- Head rejection in store (bigger air condition needed)
- Less space inside the cabinet
- Regular cleaning of condenser
- Higher energy consumption



Plug-in cabinet with characteristic machine compartment, which includes compressor, drip water evaporation and condenser.

Remote system

Advantages:

- Lower system energy consumption
- Low-noise
- Large usable volume for products
- Wide range of multiplexing options
- Open Cabinet de-humidify store climate

Trade-offs:

- Installation needed
- Fixed installation, not flexible

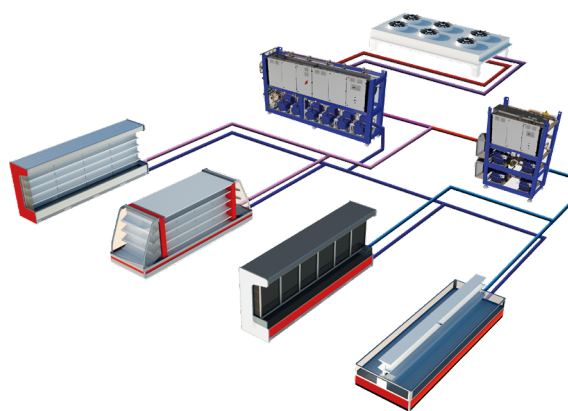

Remote cabinets connected to the central rack with the gas cooler

Excellence in tests and qualification of cabinets

Outstanding technology based on 60 years development experience

With around twenty testing rooms, Carrier is one of the best-equipped manufacturers in Europe. Most testing rooms are equipped, according to the ISO 23953 standard (refrigerated display cabinets classification, requirement and test conditions), to ensure comparable and good product performance. Besides fulfilling ISO 23953 requirements, Carrier has its own internal tests, standards and requirements that each cabinet has to pass before going to market. This ensures the right quality and is reflected in robust, reliable products to maximize the lifetime of each refrigerated display cabinets.

Measuring temperature performance

Carrier declares the temperature performance of the cabinet, according to the ISO 23953 standard, which defines the refrigerated cabinet requirements and test conditions.

ISO 23953 - Refrigerated display cabinets classification, requirement and test conditions

The refrigerated display cabinets are classified according to the standard ISO 23953. This standard defines the classification, requirement and test conditions for representative refrigerated display cabinets including: the minimum size of the test room, side air-flow, light intensity, temperature and humidification control, calibrated measurements, etc.

Thanks to ISO 23953, customers can compare temperature classification according to the same testing procedure for all manufacturers in Europe who strictly follow the standard.

Climate room requirements and setup

ISO 23953 defines exactly the requirements and tolerances of a climate room including:

- Size of the room
- Side airflow speed and direction relative to the cabinet
- Calibration of the measurement equipment
- Where to place the cabinet in the climate room
- Color of room and light intensity

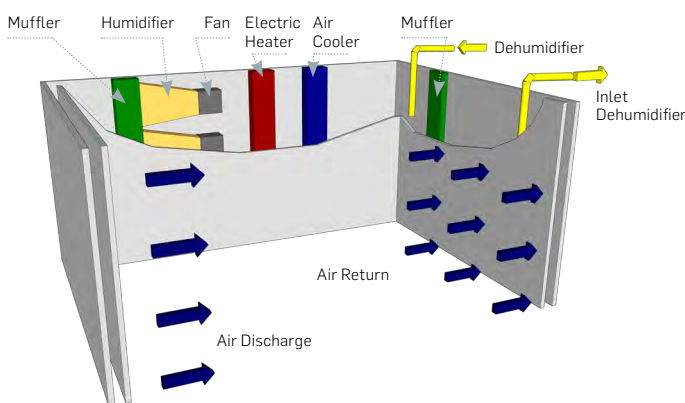

Example of Carrier testing room. The above picture illustrates how a climate room for testing the refrigeration equipment looks like.

Climate class – describes the environment outside of the cabinet

Of the several climate classes available under the standard, commercial refrigeration usually performs class 3 to measure and declare the temperature performance.

Example: "climate class 3"
Temperature: 25 °C
Rel. humidity: 60 %

Temperature class – describes the temperature performance inside the cabinet

The temperature performance is tested in a cabinet with product-simulation models which are called M-package. The M-package simulates thermal characteristic of meat products.

Cabinet temperature performance means:

- How well the cabinet holds the temperature of a chilled or frozen product – simulation models at lab climate conditions
- How small the cabinet storage temperature deviation of product is – simulation models at lab climate conditions
- Temperature performance is tested by simulating different operation use cases: shop closed (light off, night curtain down, no door opening) shop open and commissioning of cabinet (doors / lids long open) shop open consumer take products (regular door / lid opening)

There are three main temperature class groups: Low, Medium and High temperature. These main groups are split in different temperature classes indicated by a number following the group letter: Example M2. The higher the number the higher the difference between the lowest M-package temperature and highest M-package temperature.

Example: "Temperature Class M2"
(Medium temperature class 2)
Warmest M-package: max. +7°C
Coldest M-package: min. -1 °C

Link between climate class and temperature class

Because the temperature inside a cabinet is strongly influenced by the environment's temperature and humidity, the temperature class is only a meaningful declaration if it is linked to a climate class. For this reason, a full cabinet declaration always consists out of climate class and temperature class.

Example "3M2" (At climate class 3, the cabinet reaches temperature performance M2)
3= climate class (certain ambient test condition during testing)
M2= Temperature class (specified highest and lowest M-package temperature)

Laboratory vs. operation in real store environment

According to the ISO 23953-2 standard Appendix B, there are significantly different operation conditions between lab and store operation, especially for remote cabinets. The following section describes and explains the difference to the application in the field.

Difference between laboratory and store data for remote cabinets

The conditions of a remote cabinet in the store differ very much from the lab conditions. Usually the cabinets in a store are multiplexed, located against a wall and the ambient conditions are lower. Using direct lab data for remote cabinets would lead to an oversizing of piping and compressor racks. Based on this, Carrier provides E6 remote cabinets in the technical data sheets rack sizing data for the standard configuration at store condition 25°C / 60% rel. H. and 22°C / 55% rel. h. This data is available and optimized for each investment and life cycle.

Based on Carrier's leading expertise in refrigerant system design, our general recommendation is:

- Rack design data 25/60 application:
Stores in warm climates, stores with difficult climate situations, cabinet in a non-ideal place (high humidity, high temperature, close to a door etc...)
- Rack design data 22/55 application:
Store in middle and north Europe, stores with moderate climate (with air conditions, multiplexing remote cabinets)

Technical data for plug-in cabinets

To have comparable energy consumption within the Carrier range, we specify the energy consumption for the standard configuration of plug-in cabinets according to ISO 23953 and climate class 3 conditions. This makes the data comparable; however, the real energy consumption in a store is usually lower.

Influence of the cabinet installation on the performance

The installation can have major effects on the energy and temperature performance. There are some requirements, which need to be kept to ensure that the cabinets are working properly.

- Do not install the cabinet outside or next to heating radiators or other heat sources
- Keep a distance from the wall as indicated in the operating manual
- Avoid direct sunlight radiation impact
- Keep free the air intake and outlet area (only plug-in)

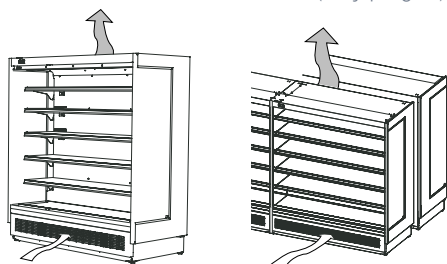

Example of a plug-in cabinet which needs free air flow on front and top of cabinet.

Carrier internal testing

To ensure a long life-time and proper operation, Carrier has defined internal standards for robustness and stress tests of cabinets as well as components.

Static robustness test

To test the cabinet and shelf strength, all shelves are loaded with a certain weight for several days. The deflection of brackets and shelves is checked under load and after unloading the cabinet. Only if the cabinet deflection and deformation stays within the small tolerances defined by the Carrier quality department, the cabinet will be released to the market. With high requirements on cabinet stability and strength, Carrier ensures a high-quality product that is safe and stable for years of operation.

Dynamic testing of doors and lids

The door opening test makes it possible to simulate several years of usage that our doors, hinges, and handles are likely to experience within just a few weeks. During the test, the system is continuously monitored and checked in terms of abrasion, break / damage and deformation. The system will only pass the internal qualification if it can resist several simulated years in the tough life of a supermarket.

For double glass doors, Carrier requires additional tests to ensure that the sealing works properly and the doors do not get condensation between the glasses after some years.

Packaging and shipping test

Before each serial launch, Carrier conducts a special packaging and transportation test. This happens with one or several cabinets in a truck going on a defined road with various road conditions. After the transport, the cabinet and the packaging are checked visually. This ensures that the cabinets will arrive to our customers in the same condition as they were packaged in the factory.

CE (Conformité Européenne) certification

The Carrier cabinets are compliant with the relevant standards or parts of the standards as confirmed with the CE declaration of conformity:

- ISO 23953-1 (Refrigerated display cabinets, general)
- ISO 23953-2 (Refrigerated display cabinets, requirement)
- EN 60335-1 (Household and similar electrical appliances. Safety. General requirements)
- EN 60335-2-89 (safety requirement for household and similar electrical appliances, particularly for commercial refrigerating appliances)

To ensure maximum safety, all plug-in cabinets with flammable refrigerant are additionally CE certified by an independent body.

Factory certifications

All Carrier cabinet factories have a certified quality management and environmental management systems

- EN ISO 9001 (General quality management system)
- EN ISO 14001 (Environmental management systems)



Irios® GL+ with E6 Velando® AF.
Corner bumpers by local customization



E6 Monaxis

OBST + GEMÜSE



E6 Mirado® and E& Mirado® GS

Technical information



WURST

FLEISCH

ISB-Wurst

FISCH

Irios® GL+ with E6 Mirado® GS, E6 Monaxis®
and Danaos® Easy Opening counter



E6 Methos GD. Inox bumpers by local customization



Ivando® GL+



E6 Methos GD with E6 Methos as crown end. Inox bumpers by local customization



Irios® GL+ with E6 Velando® 53. Inox bumpers by local customization

Complete & Sustainable Refrigeration Solutions for Food Retailers

Project Planning

- Display cabinets to maximize merchandising opportunities
- Energy and environmental impact consulting and analysis
- Optimal refrigeration technology solutions for each store type
- Complete project design and documentation



Product Development & Manufacturing

- Next-generation display cabinets to help increase sales
- Advanced refrigeration technology and integrated systems
- Energy-efficient solutions for the system lifecycle
- Sustainable natural refrigerant technologies



Lifecycle Care

- Preventative maintenance program
- 24/7 call center and service assistance
- Remote monitoring to ensure optimized performance
- System modernization for improved efficiency

Installation

- Approach tailored to unique customer requirements
- Experienced teams with standard work processes
- A focus on quality throughout the process
- Limited on-site time for minimal business disruption



Carrier Commercial Refrigeration is a leading supplier of high-efficiency turnkey refrigeration systems and services in the food retail industry.

www.carrier-refrigeration.com

